

# Data Structures and Algorithms in Java

SECOND EDITION

**Adam Drozdek**

**THOMSON**  
★  
**COURSE TECHNOLOGY**™

---

Australia • Canada • Mexico • Singapore • Spain • United Kingdom • United States



# Data Structures and Algorithms in Java

SECOND EDITION

**Adam Drozdek**

# Data Structures and Algorithms in Java

SECOND EDITION

**Adam Drozdek**

**THOMSON**  
★  
**COURSE TECHNOLOGY**™

---

Australia • Canada • Mexico • Singapore • Spain • United Kingdom • United States



**Data Structures and Algorithms in Java, Second Edition**  
by Adam Drozdek

Senior Acquisitions Editor: *Amy Yarnevich*  
Product Manager: *Alyssa Pratt*  
Editorial Assistant: *Amanda Piantedosi*  
Senior Marketing Manager: *Karen Sietz*

Production Editor: *Jennifer Harvey*  
Associate Product Manager: *Mirella Misiaszek*  
Cover Design: *Joel Sadagursky*  
Compositor: *Pre-Press Company, Inc.*

COPYRIGHT © 2005 Course Technology, a division of Thomson Learning, Inc.  
Thomson Learning™ is a trademark used herein under license.

Printed in the United States of America

1 2 3 4 5 6 7 8 9 BM 06 05 04 03 02

For more information, contact Course Technology,  
25 Thomson Place, Boston, Massachusetts, 02210.  
Or find us on the World Wide Web at: [www.course.com](http://www.course.com)

ALL RIGHTS RESERVED. No part of this work covered by the copyright hereon may be reproduced or used in any form or by any means—graphic, electronic, or mechanical, including photocopying, recording, taping, Web distribution, or information storage and retrieval systems—without the written permission of the publisher.

For permission to use material from this text or product, contact us by  
Tel (800) 730-2214  
Fax (800) 730-2215  
[www.thomsonrights.com](http://www.thomsonrights.com)

Disclaimer  
Course Technology reserves the right to revise this publication and make changes from time to time in its content without notice.

ISBN 0-534-49252-5

**TO MY WIFE, BOGNA**

---

# Contents

---

<b>1</b>	<b>OBJECT-ORIENTED PROGRAMMING USING JAVA</b>	<b>1</b>
1.1	<b>Rudimentary Java</b>	<b>1</b>
1.1.1	Variable Declarations	1
1.1.2	Operators	4
1.1.3	Decision Statements	5
1.1.4	Loops	6
1.1.5	Exception Handling	6
1.2	<b>Object-Oriented Programming in Java</b>	<b>8</b>
1.2.1	Encapsulation	8
1.2.2	Abstract Data Types	16
1.2.3	Inheritance	18
1.2.4	Polymorphism	21
1.3	<b>Input and Output</b>	<b>24</b>
1.3.1	Reading and Writing Bytes	26
1.3.2	Reading Lines	27
1.3.3	Reading Tokens: Words and Numbers	28
1.3.4	Reading and Writing Primitive Data Types	29
1.3.5	Reading and Writing Objects	29
1.3.6	Random Access File	30
1.4	<b>Java and Pointers</b>	<b>31</b>
1.5	<b>Vectors in <code>java.util</code></b>	<b>35</b>
1.6	<b>Data Structures and Object-Oriented Programming</b>	<b>42</b>
1.7	<b>Case Study: Random Access File</b>	<b>42</b>
1.8	<b>Exercises</b>	<b>51</b>
1.9	<b>Programming Assignments</b>	<b>53</b>
	<b>Bibliography</b>	<b>55</b>

<b>2</b>	<b>COMPLEXITY ANALYSIS</b>	<b>56</b>
2.1	Computational and Asymptotic Complexity	56
2.2	Big-O Notation	57
2.3	Properties of Big-O Notation	59
2.4	$\Omega$ and $\Theta$ Notations	61
2.5	Possible Problems	62
2.6	Examples of Complexities	62
2.7	Finding Asymptotic Complexity: Examples	64
2.8	The Best, Average, and Worst Cases	66
2.9	Amortized Complexity	69
2.10	NP-Completeness	73
2.11	Exercises	76
	Bibliography	79
<b>3</b>	<b>LINKED LISTS</b>	<b>80</b>
3.1	Singly Linked Lists	80
	3.1.1 Insertion	86
	3.1.2 Deletion	88
	3.1.3 Search	93
3.2	Doubly Linked Lists	95
3.3	Circular Lists	99
3.4	Skip Lists	101
3.5	Self-Organizing Lists	107
3.6	Sparse Tables	111
3.7	Lists in <code>java.util</code>	114
	3.7.1 <code>LinkedList</code>	114
	3.7.2 <code>ArrayList</code>	120
3.8	Concluding Remarks	123
3.9	Case Study: A Library	124
3.10	Exercises	134
3.11	Programming Assignments	136
	Bibliography	139



<b>4</b>	<b>STACKS AND QUEUES</b>	<b>140</b>
4.1	Stacks 140	
4.1.1	Stacks in <code>java.util</code> 148	
4.2	Queues 149	
4.3	Priority Queues 157	
4.4	Case Study: Exiting a Maze 158	
4.5	Exercises 164	
4.6	Programming Assignments 166	
	Bibliography 168	
<b>5</b>	<b>RECURSION</b>	<b>169</b>
5.1	Recursive Definitions 169	
5.2	Method Calls and Recursion Implementation 172	
5.3	Anatomy of a Recursive Call 174	
5.4	Tail Recursion 178	
5.5	Nontail Recursion 179	
5.6	Indirect Recursion 185	
5.7	Nested Recursion 187	
5.8	Excessive Recursion 188	
5.9	Backtracking 191	
5.10	Concluding Remarks 198	
5.11	Case Study: A Recursive Descent Interpreter 199	
5.12	Exercises 207	
5.13	Programming Assignments 210	
	Bibliography 212	
<b>6</b>	<b>BINARY TREES</b>	<b>214</b>
6.1	Trees, Binary Trees, and Binary Search Trees 214	
6.2	Implementing Binary Trees 219	
6.3	Searching a Binary Search Tree 221	
6.4	Tree Traversal 223	
6.4.1	Breadth-First Traversal 224	
6.4.2	Depth-First Traversal 225	
6.4.3	Stackless Depth-First Traversal 231	

6.5	<b>Insertion</b>	239
6.6	<b>Deletion</b>	242
6.6.1	Deletion by Merging	243
6.6.2	Deletion by Copying	246
6.7	<b>Balancing a Tree</b>	249
6.7.1	The DSW Algorithm	252
6.7.2	AVL Trees	255
6.8	<b>Self-Adjusting Trees</b>	260
6.8.1	Self-Restructuring Trees	261
6.8.2	Splaying	262
6.9	<b>Heaps</b>	267
6.9.1	Heaps as Priority Queues	269
6.9.2	Organizing Arrays as Heaps	272
6.10	<b>Polish Notation and Expression Trees</b>	275
6.10.1	Operations on Expression Trees	277
6.11	<b>Case Study: Computing Word Frequencies</b>	280
6.12	<b>Exercises</b>	289
6.13	<b>Programming Assignments</b>	292
	<b>Bibliography</b>	296

## 7 MULTIWAY TREES 299

7.1	<b>The Family of B-Trees</b>	300
7.1.1	B-Trees	301
7.1.2	B*-Trees	312
7.1.3	B <sup>+</sup> -Trees	313
7.1.4	Prefix B <sup>+</sup> -Trees	316
7.1.5	Bit-Trees	319
7.1.6	R-Trees	320
7.1.7	2–4 Trees	323
7.1.8	Trees in <code>java.util</code>	338
7.2	<b>Tries</b>	349
7.3	<b>Concluding Remarks</b>	358
7.4	<b>Case Study: Spell Checker</b>	358
7.5	<b>Exercises</b>	369
7.6	<b>Programming Assignments</b>	370
	<b>Bibliography</b>	374

<b>8</b>	<b>GRAPHS</b>	<b>376</b>
8.1	Graph Representation	377
8.2	Graph Traversals	379
8.3	Shortest Paths	383
8.3.1	All-to-All Shortest Path Problem	390
8.4	Cycle Detection	392
8.4.1	Union-Find Problem	393
8.5	Spanning Trees	395
8.6	Connectivity	399
8.6.1	Connectivity in Undirected Graphs	399
8.6.2	Connectivity in Directed Graphs	402
8.7	Topological Sort	405
8.8	Networks	407
8.8.1	Maximum Flows	407
8.8.2	Maximum Flows of Minimum Cost	417
8.9	Matching	421
8.9.1	Stable Matching Problem	426
8.9.2	Assignment Problem	428
8.9.3	Matching in Nonbipartite Graphs	430
8.10	Eulerian and Hamiltonian Graphs	432
8.10.1	Eulerian Graphs	432
8.10.2	Hamiltonian Graphs	436
8.11	Graph Coloring	442
8.12	NP-Complete Problems in Graph Theory	445
8.12.1	The Clique Problem	445
8.12.2	The 3-Colorability Problem	446
8.12.3	The Vertex Cover Problem	448
8.12.4	The Hamiltonian Cycle Problem	449
8.13	Case Study: Distinct Representatives	450
8.14	Exercises	460
8.15	Programming Assignments	464
	Bibliography	466

<b>9</b>	<b>SORTING</b>	<b>469</b>
9.1	Elementary Sorting Algorithms	470
9.1.1	Insertion Sort	470
9.1.2	Selection Sort	474
9.1.3	Bubble Sort	475
9.2	Decision Trees	477
9.3	Efficient Sorting Algorithms	481
9.3.1	Shell Sort	481
9.3.2	Heap Sort	484
9.3.3	Quicksort	488
9.3.4	Mergesort	494
9.3.5	Radix Sort	497
9.4	Sorting in <code>java.util</code>	502
9.5	Concluding Remarks	505
9.6	Case Study: Adding Polynomials	507
9.7	Exercises	515
9.8	Programming Assignments	516
	Bibliography	517
<b>10</b>	<b>HASHING</b>	<b>519</b>
10.1	Hash Functions	520
10.1.1	Division	520
10.1.2	Folding	520
10.1.3	Mid-Square Function	521
10.1.4	Extraction	521
10.1.5	Radix Transformation	522
10.2	Collision Resolution	522
10.2.1	Open Addressing	522
10.2.2	Chaining	528
10.2.3	Bucket Addressing	530
10.3	Deletion	531
10.4	Perfect Hash Functions	532
10.4.1	Cichelli's Method	533
10.4.2	The FHCD Algorithm	536
10.5	Hash Functions for Extendible Files	538
10.5.1	Extendible Hashing	539
10.5.2	Linear Hashing	541

10.6	Hashing in <code>java.util</code>	544	
	10.6.1 <code>HashMap</code>	544	
	10.6.2 <code>HashSet</code>	547	
	10.6.3 <code>HashTable</code>	552	
10.7	Case Study: Hashing with Buckets	557	
10.8	Exercises	566	
10.9	Programming Assignments	567	
	Bibliography	568	
<b>11</b>	<b>DATA COMPRESSION</b>		<b>570</b>
11.1	Conditions for Data Compression	570	
11.2	Huffman Coding	572	
	11.2.1 Adaptive Huffman Coding	581	
11.3	Run-Length Encoding	586	
11.4	Ziv-Lempel Code	587	
11.5	Case Study: Huffman Method with Run-Length Encoding	590	
11.6	Exercises	601	
11.7	Programming Assignments	601	
	Bibliography	603	
<b>12</b>	<b>MEMORY MANAGEMENT</b>		<b>604</b>
12.1	The Sequential-Fit Methods	605	
12.2	The Nonsequential-Fit Methods	606	
	12.2.1 Buddy Systems	608	
12.3	Garbage Collection	615	
	12.3.1 Mark-and-Sweep	616	
	12.3.2 Copying Methods	623	
	12.3.3 Incremental Garbage Collection	625	
12.4	Concluding Remarks	633	
12.5	Case Study: An In-Place Garbage Collector	634	
12.6	Exercises	643	
12.7	Programming Assignments	644	
	Bibliography	647	

## 13 STRING MATCHING 649

- 13.1 **Exact String Matching** 649
  - 13.1.1 Straightforward Algorithms 649
  - 13.1.2 The Knuth-Morris-Pratt Algorithm 652
  - 13.1.3 The Boyer-Moore Algorithm 660
  - 13.1.4 Multiple Searches 670
  - 13.1.5 Bit-Oriented Approach 672
  - 13.1.6 Matching Sets of Words 676
  - 13.1.7 Regular Expression Matching 682
  - 13.1.8 Suffix Tries and Trees 686
  - 13.1.9 Suffix Arrays 693
- 13.2 **Approximate String Matching** 694
  - 13.2.1 String Similarity 695
  - 13.2.2 String Matching with  $k$  Errors 701
- 13.3 **Case Study: Longest Common Substring** 704
- 13.4 **Exercises** 713
- 13.5 **Programming Assignments** 715
  - Bibliography** 716

## APPENDIXES

- A **Computing Big-O** 718
  - A.1 Harmonic Series 718
  - A.2 Approximation of the Function  $\lg(n!)$  718
  - A.3 Big-O for Average Case of Quicksort 720
  - A.4 Average Path Length in a Random Binary Tree 722
  - A.5 The Number of Nodes in an AVL Tree 723
- B **NP-Completeness** 724
  - B.1 Cook's Theorem 724

Name Index 737

Subject Index 740

---

# Preface

---

The study of data structures, a fundamental component of a computer science education, serves as the foundation upon which many other computer science fields are built. Some knowledge of data structures is a must for students who wish to do work in design, implementation, testing, or maintenance of virtually any software system. The scope and presentation of material in *Data Structures and Algorithms in Java* provide students with the knowledge necessary to perform such work.

This book highlights three important aspects of data structures. First, a very strong emphasis is placed on the connection between data structures and their algorithms, including analyzing algorithms' complexity. Second, data structures are presented in an object-oriented setting in accordance with the current design and implementation paradigm. In particular, the information-hiding principle to advance encapsulation and decomposition is stressed. Finally, an important component of the book is data structure implementation, which leads to the choice of Java as the programming language.

The Java language, an object-oriented descendant of C and C++, has gained popularity in industry and academia as an excellent programming language due to widespread use of the Internet. Because of its consistent use of object-oriented features and the security of the language, Java is also useful and natural for introducing data structures. Currently, C++ is the primary language of choice for teaching data structures; however, because of the wide use of Java in application programming and the object-oriented characteristics of the language, using Java to teach a data structures and algorithms course, even on the introductory level, is well justified.

This book provides the material for a course that includes the topics listed under CS2 and CS7 of the old ACM curriculum. It also meets the requirements for most of the courses  $C_A$  202,  $C_D$  202, and  $C_F$  204 of the new ACM curriculum.

Most chapters include a case study that illustrates a complete context in which certain algorithms and data structures can be used. These case studies were chosen from different areas of computer science such as interpreters, symbolic computation, and file processing, to indicate the wide range of applications to which topics under discussion may apply.

Brief examples of Java code are included throughout the book to illustrate the practical importance of data structures. However, theoretical analysis is equally important. Thus, presentations of algorithms are integrated with analyses of efficiency.

Great care is taken in the presentation of recursion because even advanced students have problems with it. Experience has shown that recursion can be explained best if the run-time stack is taken into consideration. Changes to the stack are shown when tracing a recursive function not only in the chapter on recursion, but also in other chapters. For example, a surprisingly short method for tree traversal may remain a mystery if work done by the system on the run-time stack is not included in the explanation. Standing aloof from the system and retaining only a purely theoretical perspective when discussing data structures and algorithms are not necessarily helpful. This book also includes comprehensive chapters on data compression and memory management.

The thrust of this book is data structures, and other topics are treated here only as much as necessary to ensure a proper understanding of this subject. Algorithms are discussed from the perspective of data structures, so the reader will not find a comprehensive discussion of different kinds of algorithms and all the facets that a full presentation of algorithms requires. However, as mentioned, recursion is covered in depth. In addition, complexity analysis of algorithms is presented in some detail.

Chapters 1 and 3–8 present a number of different data structures and the algorithms that operate on them. The efficiency of each algorithm is analyzed, and improvements to the algorithm are suggested.

- Chapter 1 presents the basic principles of object-oriented programming, an introduction to dynamic memory allocation and the use of pointers, and a rudimentary introduction to Java.
- Chapter 2 describes some methods used to assess the efficiency of algorithms.
- Chapter 3 contains an introduction to linked lists.
- Chapter 4 presents stacks and queues and their applications.
- Chapter 5 contains a detailed discussion of recursion. Different types of recursion are discussed, and a recursive call is dissected.
- Chapter 6 discusses binary trees, including implementation, traversal, and search. This chapter also includes balanced trees.
- Chapter 7 details more generalized trees such as tries, 2–4 trees, and B-trees.
- Chapter 8 presents graphs.

Chapters 9–12 show different applications of data structures introduced in the previous chapters. They emphasize the data structure aspects of each topic under consideration.

- Chapter 9 analyzes sorting in detail, and several elementary and nonelementary methods are presented.



- Chapter 10 discusses hashing, one of the most important areas in searching. Various techniques are presented with an emphasis on the utilization of data structures.
- Chapter 11 discusses data compression algorithms and data structures.
- Chapter 12 presents various techniques and data structures for memory management.
- Chapter 13 discusses many algorithms for exact and approximate string matching.
- Appendix A discusses in greater detail big-O notation, introduced in Chapter 2.
- Appendix B gives a proof of Cook's theorem and illustrates it with an extended example.

Each chapter contains a discussion of the material illustrated with appropriate diagrams and tables. Except for Chapter 2, all chapters include a case study, which is an extended example using the features discussed in that chapter. All case studies have been tested using the Visual C++ compiler on a PC and the g++ compiler under UNIX except the von Koch snowflake, which runs on a PC under Visual C++. At the end of each chapter is a set of exercises of varying degrees of difficulty. Except for Chapter 2, all chapters also include programming assignments and an up-to-date bibliography of relevant literature.

Chapters 1–6 (excluding Sections 2.9, 3.4, 6.4.3, 6.7, and 6.8) contain the core material that forms the basis of any data structures course. These chapters should be studied in sequence. The remaining six chapters can be read in any order. A one-semester course could include Chapters 1–6, 9, and Sections 10.1 and 10.2. The entire book could also be part of a two-semester sequence.

## TEACHING TOOLS

**Electronic Instructor's Manual.** The Instructor's Manual that accompanies this textbook includes complete solutions to all text exercises.

**Electronic Figure Files.** All images from the text are available in bitmap format for use in classroom presentations.

**Source Code.** The source code for the text example programs is available via the author's Web site at <http://www.mathes.dug.edu/drozdek/DSinJava>.

It is also available for student download at [course.com](http://course.com). All teaching tools, outlined above, are available in the Instructor's Resources section of [course.com](http://course.com).

## CHANGES IN THE SECOND EDITION

The new edition primarily extends the old edition by including material on new topics that are currently not covered. The additions include

- Pattern matching algorithms in the new Chapter 13
- A discussion of NP-completeness in the form of a general introduction (Section 2.10), examples of NP-complete problems (Section 8.12), and an outline of Cook's theorem (Appendix B)
- New material on graphs (Sections 8.9.1, 8.10.1.1, 8.10.2.1, and 8.11)
- A discussion of a deletion algorithm for vh-trees (Section 7.1.7)
- An introduction to Java files (Sections 1.3.1–1.3.6)

Moreover, the tables that list methods from `java.util` packages have been updated. There are also many small modifications and additions throughout the book.

## ACKNOWLEDGMENTS

I would like to thank the following reviewers, whose comments and advice helped me to improve this book:

James Ball, Indiana State University

Robin Dawes, Queen's University

Julius Dichter, University of Bridgeport

However, the ultimate content is my responsibility, and I would appreciate hearing from readers about any shortcomings or strengths. My email address is [drozdek@duq.edu](mailto:drozdek@duq.edu).

*Adam Drozdek*

# Object-Oriented Programming Using Java



This chapter introduces the reader to elementary Java. Java is an immense language and programming environment, and it is impossible to touch upon all Java-related issues within the confines of one chapter. This chapter introduces only those aspects of Java that are necessary for understanding the Java code offered in this book. The reader familiar with Java can skip this chapter.

## 1.1 RUDIMENTARY JAVA

A Java program is a sequence of statements that have to be formed in accordance with the predefined syntax. A statement is the smallest executable unit in Java. Each statement ends with a semicolon. Compound statements, or blocks, are marked by delimiting them with braces, { and }.

### 1.1.1 Variable Declarations

Each variable must be declared before it can be used in a program. It is declared by specifying its type and its name. Variable names are strings of any length of letters, digits, underscores, and dollar signs that begin with a letter, underscore, or dollar sign. However, a letter is any Unicode letter (a character above 192), not just 1 of the 26 letters in the English alphabet. Local variables must be initialized. Java is case sensitive, so variable `n` is different from variable `N`.

A type of variable is either one of the eight built-in basic types, a built-in or user-defined class type, or an array. Here are built-in types and their sizes:

Type	Size	Range
<code>boolean</code>	1 bit	<code>true</code> , <code>false</code>
<code>char</code>	16 bits	Unicode characters
<code>byte</code>	8 bits	[-128, 127]
<code>short</code>	16 bits	[-32768, 32767]
<code>int</code>	32 bits	[-2147483648, 2147483647]
<code>long</code>	64 bits	[-9223372036854775808, 9223372036854775807]
<code>float</code>	32 bits	[-3.4E38, 3.4E38]
<code>double</code>	64 bits	[-1.7E308, 1.7E308]

Note that the sizes of the types are fixed, which is extremely important for portability of programs. In *C/C++*, the size of integers and long integers is system dependent. Unlike *C/C++*, `boolean` is not a numeric type, and no arithmetic operations can be performed on `boolean` variables. But as in *C/C++*, characters are considered integers (in Java, they are unsigned integers) so that they can be operands of arithmetic operations.

Integer operations are performed with 32-bit precision (for long integers, it is 64-bit precision); therefore, operations on `byte` and `short` variables require a cast. For example, the statements

```
byte a, b = 1, c = 2;
a = b + c;
```

give a compilation error, “incompatible type for =. Explicit cast is needed to convert `int` to `byte`.” The addition `b + c` gives an integer value that must be cast to execute the assignment to the `byte` variable `a`. To avoid the problem, the assignment should be changed to

```
a = (byte) (b + c);
```

An overflow resulting from an arithmetic operation (unless it is division by zero) is not indicated, so the programmer must be aware that, for two integers,

```
int i = 2147483647, j = i + 1;
```

the value of `j` is `-2147483648`.

Java does not provide modifiers `signed` and `unsigned`, but it has other modifiers.

An important difference between *C/C++* and Java is characters that are 8 bits long in *C/C++* and 16 bits long in Java. With the usual 8-bit characters, only 256 different characters can be represented. To address the problem of representing characters of languages other than English, the set of available codes must be significantly extended. The problem is not only with representing letters with diacritical marks (e.g., Polish letter `ń`, Romanian letter `ț`, or Danish letter `ø`), but also with non-Latin characters such as Cyrillic, Greek, Japanese, Chinese, and so on. By allowing a character variable to be of 2 bytes, the number of different characters represented now equals 65,536.

To assign a specific Unicode character to a character variable, “u” followed by four hexadecimal digits can be used; for example,

```
char ch = '\u12ab';
```

However, high Unicode codes should be avoided, because as of now, few systems display them. Therefore, although the assignment to `ch` just given is legal, printing the value of `ch` results in displaying a question mark.

Other ways of assigning literal characters to character variables is by using a character surrounded with single quotes,

```
ch = 'q';
```

and using a character escape sequence, such as

```
ch = '\n';
```

to assign an end-of-line character; other possibilities are: `'\t'` (tab), `'\b'` (backspace), `'\r'` (carriage return), `'\f'` (formfeed), `'\''` (single quote), `'\"'` (double quote), and `'\''` (backslash). Unlike C/C++, `'\b'` (bell) and `'\v'` (vertical tab) are not included. Moreover, an octal escape sequence `'\ddd'` can be used, as in

```
ch = '\123'; // decimal 83, ASCII of 'S';
```

where `ddd` represents an octal number [0, 377].

Integer literals can be expressed as decimal numbers by any sequence of digits 0 through 9,

```
int i = 123;
```

as octal numbers by 0 followed by any sequence of digits 0 through 7,

```
int j = 0123; // decimal 83;
```

or as hexadecimal numbers by “0x” followed by any sequence of hexadecimal numbers 0 through 9 and A through F (lower- or uppercase),

```
int k = 0x123a; // decimal 4666;
```

Literal integers are considered 32 bits long; therefore, to convert them to 64-bit numbers, they should be followed by an “L”:

```
long p = 0x123aL;
```

Note that uppercase *L* should be used rather than lowercase *l* because the latter can be easily confused with the number 1.

Floating-point numbers are any sequences of digits 0 through 9 before and after a period; the sequences can be empty: 2., .2, 1.2. In addition, the number can be followed by a letter *e* and a sequence of digits possibly preceded by a sign: 4.5e+6 (=  $4.5 \cdot 10^6 = 4500000.0$ ), 102.055e-3 =  $102.055 \cdot 10^{-3} = .102055$ ). Floating-point literals are 64-bit numbers by default; therefore, the declaration and assignment

```
float x = 123.45;
```

result in a compilation error, “incompatible type for declaration. Explicit cast needed to convert double to float,” which can be eliminated by appending the modifier `f` (or `F`) at the end of the number,

```
float x = 123.45f;
```

A modifier `d` or `D` can be appended to double numbers, but this is not necessary.

### 1.1.2 Operators

Value assignments are executed with the assignment operator `=`, which can be used one at a time or can be strung together with other assignment operators, as in

```
x = y = z = 1;
```

which means that all three variables are assigned the same value, number 1. Java uses shorthand for cases when the same value is updated; for example,

```
x = x + 1;
```

can be shortened to

```
x += 1;
```

Java also uses autoincrement and autodecrement prefix and postfix operators, as in `++n`, `n++`, `--n`, and `n--`, which are shorthands of assignments `n = n + 1` and `n = n - 1`, where `n` can be any number, including a floating-point number. The difference between prefix and postfix operators is that, for the prefix operator, a variable is incremented (or decremented) first and then an operation is performed in which the increment takes place. For a postfix operator, autoincrement (or autodecrement) is the last operation performed; for example, after executing assignments

```
x = 5;
y = 6 + ++x;
```

`y` equals 12, whereas after executing

```
x = 5;
y = 6 + x++;
```

`y` equals 11. In both cases, `x` equals 6 after the second statement is completely executed.

Java allows performing operations on individual bits with bitwise operators: `&` (bitwise and), `|` (bitwise or), `^` (bitwise xor), `<<` (left shift), `>>` (right shift), `>>>` (zero filled shift right), and `~` (bitwise complement). Shorthands `&=`, `|=`, `^=`, `<<=`, `>>=`, and `>>>=` are also possible. Except for the operator `>>>`, the other operators are also in C/C++. The operator `>>` shifts out a specified number of rightmost (least significant) bits and shifts in the same number of 0s for positive numbers and 1s for negative numbers. For example, the value of `m` after the assignments

```
int n = -4;
int m = n >> 1;
```

is  $-1$  because  $-4$  in  $n$  is a two-complement representation as the sequence of 32 bits  $11 \dots 1100$ , which after shifting to the right by one bit gives in  $m$  the pattern  $11 \dots 1110$ , which is a two-complement representation of  $-2$ . To have 0s shifted in also for negative numbers, the operator  $\ggg$  should be used,

```
int n = -4;
int m = n >>> 1;
```

in which case, the pattern  $11 \dots 1100$  in  $n$  is transformed into the pattern  $01 \dots 1110$  in  $m$ , which is the number 2147483646 (one less than the maximum value for an integer).

### 1.1.3 Decision Statements

One decision statement is an `if` statement

```
if (condition)
    do something;
[else do something else;]
```

in which the word `if` is followed by a condition surrounded by parentheses, by the body of the `if` clause, which is a block of statements, and by an optional `else` clause, which is the word `else` followed by a block of statements. A condition must return a Boolean value (in C/C++, it can return any value). A condition is formed with relational operators `<`, `<=`, `==`, `!=`, `>=`, `>` that take two arguments and return a Boolean value, and with logical operators that take one (!) or two (&&, ||) Boolean arguments and return a Boolean value.

An alternative to an `if-else` statement is the conditional operator of the form

```
condition ? do-if-true : do-if-false;
```

The conditional operator returns a value, whereas an `if` statement does not, so the former can be used, for example, in assignments, as in

```
n = i <= 0 ? 10 : 20;
```

Another decision statement is a `switch` statement, which is a shorthand for nested `if` statements. Its form is as follows:

```
switch (integer expression) {
    case value1: block1; break;
    . . . . .
    case valueN: blockN; break;
    default: default block;
}
```

The test expression following `switch` must be an integer expression so that any expression of type `byte`, `char`, `short`, and `int` can be used. The value of the expression is compared to the values that follow the word `case`. If a match is found, the block of statements following this value is executed, and upon encountering `break`, the `switch` statement is exited. Note that if the word `break` is missing, then

execution is continued for the block of the next `case` clause. After executing the statement

```
switch (i) {
    case 5 : x + 10; break;
    case 6 : x = 20;
    case 7 : x *= 2; break;
    default : x = 30;
}
```

the value of `x` is 10 if `i` equals 5, 40 if `i` equals 6, it is doubled if `i` equals 7, and is 30 for any other value of `i`.

### 1.1.4 Loops

The first loop available in Java is the `while` loop:

```
while (condition)
    do something;
```

The condition must be a Boolean expression.

The second loop is a `do-while` loop:

```
do
    do something;
while (condition);
```

The loop continues until the Boolean condition is false.

The third loop is the `for` loop:

```
for (initialization; condition; increment)
    do something;
```

The initialization part may also declare variables, and these variables exist only during execution of the loop.

A loop can be exited before all the statements in its body are executed with an unlabeled `break` statement. We have already seen a `break` statement used in the `switch` statement. In the case of nested loops, when a `break` statement is encountered, the current loop is exited so that the outer loop can be continued. An unlabeled `continue` statement causes the loop to skip the remainder of its body and begin the next iteration.

### 1.1.5 Exception Handling

If an error is detected during execution of a Java program, Java throws an exception, after which the program is terminated and an error message is displayed informing the user which exception was raised (that is, what type of error occurred and where in the program it happened). However, the user may handle the error in the program should one occur, at least by making the program ignore it so that execution of the program can continue. But if an exception is raised, a special course of action can be



undertaken and then the program can continue. Catching an error is possible by using a `try-catch` mechanism.

A general format of the `try-catch` statement is

```
try {
    do something;
} catch (exception-type exception-name) {
    do something;
}
```

The number of `catch` clauses is not limited to one. There can be as many as needed, each one for a particular exception.

In this statement, execution of the body of the `try` clause is tried, and if an exception occurs, control is transferred to the `catch` clause to execute its body. Then execution of the program continues with a statement following the `try-catch` statement, unless it contains the `throw` clause, which causes an exit from the method.

Consider the following method:

```
public int f1(int[] a, int n) throws ArrayIndexOutOfBoundsException {
    return n * a[n+2];
}
```

The `throws` clause in the heading of the method is a warning to the user of the method that a particular exception can occur, and if not handled properly, the program crashes. To prevent that from happening, the user may include the `try-catch` statement in the caller of `f1()`:

```
public void f2() {
    int[] a = {1,2,3,4,5};
    try {
        for (int i = 0; i < a.length; i++)
            System.out.print(f1(a,i) + " ");
    } catch (ArrayIndexOutOfBoundsException e) {
        System.out.println("Exception caught in f2()");
        throw e;
    }
}
```

The `catch` clause prints a message, but it does not perform any fixing operation on the array `a`, although it could. In this example, the `catch` clause also includes the `throw` statement, although this is not very common. In this way, not only is the exception caught and handled in `f2()`, but also a caller of `f2()` is forced to handle it, as in the method `f3()`:

```
public void f3() {
    try {
        f2();
    } catch (ArrayIndexOutOfBoundsException e) {
        System.out.println("Exception caught in f3()");
    }
}
```

If the caller of `f2()` does not handle the exception, the program crashes, although the exception was caught in `f2()`. The same fate meets a program if a caller of `f1()` does not catch the exception:

```
public void f4() {
    int[] a = {1,2,3,4,5};
    for (int i = 0; i < a.length; i++)
        System.out.print(f1(a,i) + " ");
}
```

Note that the behavior of the program in all these cases is the same (that is, handling an exception, passing it to another method, or crashing the program) if the `throws` clause is not included in the heading of `f1()` so that `f1()` could simply be:

```
public int f1(int[] a, int n) {
    return n * a[n+2];
}
```

The `throws` clause is thus a very important signal for the user to a possible problem that may occur when calling a particular method.

Not all types of exceptions can be ignored as the exception raised by `f1()` is ignored by `f4()`. Most of the time, exceptions have to be handled in the program; otherwise, the program does not compile. This, for instance, is the case with `IOException` thrown by I/O methods; therefore, these methods are usually called inside `try-catch` clauses.

## 1.2 OBJECT-ORIENTED PROGRAMMING IN JAVA

### 1.2.1 Encapsulation

Object-oriented programming (OOP) revolves around the concept of an object. Objects, however, are created using a class definition. A *class* is a template in accordance to which objects are created. A class is a piece of software that includes a data specification and functions operating on these data and possibly on the data belonging to other class instances. Functions defined in a class are called *methods*, and variables used in a class are called *class scope variables* (to distinguish them from variables local to method or blocks), *data fields*, or simply *fields*. This combining of the data and related operations is called *data encapsulation*. An object is an instance of a class, an entity created using a class definition.

In contradistinction to functions in languages that are non-object-oriented languages (OOL), objects make the connection between data and methods much tighter and more meaningful. In non-OOLs, declarations of data and definitions of functions could be interspersed throughout the entire program, and only the program documentation indicates that there is a connection between them. In OOLs, a connection is established right at the outset; in fact, the program is based on this connection. An object encompasses related data and operations, and because there may be many objects used in the same program, the objects communicate by exchanging messages, thereby re-

vealing to each other only as much, or rather as little, detail about their internal structure as necessary for adequate communication. Structuring programs in terms of objects allows us to accomplish several goals.

First, this strong coupling of data and operations can be used much better in modeling a fragment of the world, which is emphasized especially by software engineering. Not surprisingly, OOP has its roots in simulation; that is, in modeling real-world events. The first OOL was Simula; it was developed in the 1960s in Norway.

Second, objects allow for easier error finding because operations are localized to the confines of their objects. Even if side effects can occur, they are easier to trace.

Third, objects allow us to conceal certain details of their operations from other objects so that these operations may not be adversely affected by other objects. This is known as the *information-hiding principle*. In languages that are not object-oriented, this principle can be found to some extent in the case of local variables, or as in Pascal, in local functions and procedures, which can be used and accessed only by the function defining them. This is, however, a very tight hiding or no hiding at all. Sometimes we may need to use (again, as in Pascal) a function  $f2$  defined in  $f1$  outside of  $f1$ , but we cannot. Sometimes we may need to access some data local to  $f1$  without exactly knowing the structure of these data, but in non-OOLs, we cannot. Hence, some modification is needed, and it is accomplished in OOLs.

An object in OOL is like a watch. As users, we are interested in what the hands show, but not in the inner workings of the watch. We are aware that there are gears and springs inside the watch, but we usually know very little about why all these parts are in a particular configuration. Because of that, we should not have access to this mechanism so that we do not damage it, inadvertently or on purpose. Therefore, this mechanism is hidden from us, we have no immediate access to it, and thereby the watch is protected and works better than when its mechanism is open for everyone to see.

Hence, an object is like a black box whose behavior is very well defined, and we use the object because we know what it does, not because we have an insight into how it does it. This opacity of objects is extremely useful for maintaining them independently of each other. If communication channels between the objects are well defined, then changes made inside an object can affect other objects only as much as these changes affect the communication channels. Knowing the kind of information sent out and received by an object, the object can be replaced more easily by another object more suitable in a particular situation: A new object can perform the same task differently but more quickly in a certain hardware environment. Hence, an object discloses only as much as is needed for the user to utilize it. It has a public part that can be accessed by any user when the user sends a message matching any of the method names revealed by the object. In this public part, the object displays to the user buttons that can be pushed to invoke the object's operations. The user knows only the names of these operations and the expected behavior.

Information hiding tends to blur the dividing line between data and operations. In Pascal-like languages, the distinction between data and functions/procedures is clear and rigid. They are defined differently and their roles are very distinct. OOLs put data and methods together, and to the user of the object, this distinction is much less noticeable. To some extent, this is an incorporation of features of functional languages. LISP, one of the earliest programming languages, allows the user to treat data and functions on a par, because the structure of both is the same.

We have already made a distinction between particular objects and object types or classes. We write methods to be used with different variables, and by analogy, we do not want to be forced to write as many object declarations as the number of objects required by the program. Certain objects are of the same type and we would like only to use a reference to a general object specification. For single variables, we make a distinction between type declaration and variable declaration. In the case of objects, a distinction is made between a class declaration and its instantiation, which is an object. Consider the following program:

```
class C {
    public C() {
        this("",1,0);
    }
    public C(String s) {
        this(s,1,0);
    }
    public C(String s, int i) {
        this(s,i,0);
    }
    public C(String s, int i, double d) {
        dataField1 = new String(s);
        dataField2 = i;
        dataField3 = d;
    }
    public void method1() {
        System.out.println(dataField1 + " " + dataField2 + " " + dataField3);
    }
    public void method2(int i) {
        method2(i,"unknown");
    }
    public void method2(int i, String s) {
        dataField2 = i;
        System.out.println(i + " received from " + s);
    }
    private String dataField1;
    private int dataField2;
    private double dataField3;
    public static void main (String args[]) {
        C object1 = new C("object1",100,2000),
        object2 = new C("object2"), object3 = new C();
        object1.method2(123);
        object1.method1();
        object2.method2(123,"object2");
    }
}
```

The program contains a declaration of class `C`. Inside method `main()`, objects of class type `C` are generated by declaring and instantiating them:

```
C object1 = new C("object1",100,2000),
  object2 = new C("object2"), object3 = new C();
```

It is very important to see that object declarations do not create objects, so that the two lines

```
C object1;
object1.method1();
```

result in a compilation error. The object variable `object1` has to be assigned an object, which can be done directly in declaration by initializing the variable with the operator `new`,

```
C object1 = new C(. . .);
```

*Message passing* is equivalent to a function call in traditional languages. However, to stress the fact that in OOLs the methods are relative to objects, this new term is used. For example, the call to `method1()` with respect to `object1`,

```
object1.method1();
```

is to be seen as the message `method1()` sent to `object1`. Upon receiving the message, the object invokes its method. Messages can acquire parameters so that

```
object1.method2(123);
```

is the message `method2()` with parameter `123` received by `object1`.

The lines containing these messages are in a method of the current object or another object. Therefore, the receiver of the message is identifiable, but not necessarily the sender. If `object1` receives the message `method1()`, it does not know where the message originated. It only responds to it by displaying the information `method1()` encompasses. The same goes for `method2()`. Therefore, the sender may prefer sending a message that also includes its identification, as in

```
object1.method2(123,"object1");
```

The declaration of class `C` contains the method `main()`, which, as in `C/C++`, is the starting point for execution of programs. Unlike in `C/C++`, `main()` must be included inside a class; it cannot be a stand-alone method. In this way, after class `C` is stored in a file `C.java`, the file can be compiled with the instruction

```
javac C.java
```

and then the program can be run with

```
java C
```

The `javac` instruction can be applied to any file containing Java code, but the `java` instruction requires that the class with which it is invoked includes method `main()`. The example of class `C` shows only one class, but as we shall see throughout the book, the number of classes is usually not limited to one; however, one of the classes must include the method `main()` to make the program executable.

The signature of the method `main()` is always the same:

```
public static void main(String[] args)
```

It returns no value (`void`) and allows for taking command line arguments from the interpreter by storing them in an array of strings. The `public` modifier belongs to the category of access modifiers. Java uses four access modifiers (three plus one unnamed), which are related to the concept of a package. A package is a collection of classes that are located in one subdirectory. It is a counterpart of a `C/C++` library.

Methods and fields declared `public` can be used by any other object.

The `protected` modifier means that a method or a field is accessible to derived classes and in the package that includes the class that declares the method or the data field.

The `private` modifier indicates methods and fields that can be used only by this class.

A default modifier is no modifier at all, which indicates access to methods and fields in the package that includes the class that declares the method or the data field.

Two more modifiers need to be listed. A `final` method or field cannot be changed by derived classes (see Section 1.2.3, Inheritance). A method and field declared `static` are the same for all instances (objects) of the class.

### 1.2.1.1 Class Methods and Class Variables

Static methods and variables are associated with the class itself; there is exactly one instance of a static element even if there is no object of the particular class type. They are called *class methods* and *class variables* (nonstatic variables and methods are called *instance variables* and *instance methods*). The method `main()` must be declared as `static`. Then, all methods and variables it uses directly must also be static (method `f()` called by `main()` must be static, but not when it is called as `obj.f()`). Consider this class:

```
class C2 {
    public void f1() {
        System.out.println("f1()");
    }
    static public void f2() {
        System.out.println("f2()");
    }
}
```

Because `f1()` is not a class method, the command

```
C2.f1(); // error;
```

causes a compilation error; thus, to execute the method, an object of class type C2 has to be created, and then the method invoked, as in

```
C2 c = new C2();
c.f1();
```

or simply

```
(new C2()).f1();
```

On the other hand, because `f2()` is a class method, the command

```
C2.f2();
```

is sufficient because the method `f2()` does exist in class C2, even without creating an object of class type C2; that is, a static method can be accessed through a class name, although it can also be accessed through an object name. This is how methods in class `Math` can be accessed, for example, `Math.sqrt(123)`.

To see how class variables work, consider this class,

```
class C3 {
    public static int n = 0;
    public int m = 0;
    public C3() {
        n++; m++;
    }
    public void display() {
        System.out.println(n + " " + m);
    }
}
```

Execution of

```
C3 c1 = new C3();
c1.display();
C3 c2 = new C3();
c1.display();
c2.display();
```

prints numbers

```
1 1
2 1
2 1
```

Also, `n` and `m` can be accessed and modified from the outside, as in

```
C3.n = 10;
c1.m = 11;
c2.m = 12;
```

Note that the class name is used to access `n` and the object name to access `m`.

### 1.2.1.2 Generic Classes

A very important aspect of OOP in Java is the possibility of declaring generic classes. For example, if we need to declare a class that uses an array for storing some items, then we may declare this class as

```
class IntClass {
    int[] storage = new int[50];
    .....
}
```

However, in this way, we limit the usability of this class to integers only; hence, if a class is needed that performs the same operations as `IntClass`, but it operates on double numbers, then a new declaration is needed, such as

```
class DoubleClass {
    double[] storage = new double[50];
    .....
}
```

If `storage` is to hold objects of a particular class, then another class must be declared. It is much better to declare a generic class and decide during the run of the program to which type of items it is referring. Java allows us to declare a class in this way, and the declaration for the example is

```
class GenClass {
    Object[] storage = new Object[50];
    Object find(int n) {
        return storage[n];
    }
    .....
}
```

Then the decision is made as to how to create two specific objects:

```
GenClass intObject = new GenClass();
GenClass doubleObject = new GenClass();
```

This generic class manifests itself in different forms depending on the way information is stored in it or retrieved from it. To treat it as an object holding an array of integers, the following way of accessing data can be used:

```
int k = ((Integer) intObject.find(n)).intValue();
```

To retrieve data from `doubleObject`, the return value has to be cast as `Double`. The same cast can also be used for `intObject` so that objects respond differently in different situations. One generic declaration suffices for enabling such different forms.



### 1.2.1.3 Arrays

Arrays are Java objects, but to the user, they are objects to a very limited extent. There is no keyword with which all arrays are declared. They may be considered instances of an understood array class. The lack of a keyword for all arrays also means that no subclasses can be created (see Section 1.2.3).

Arrays are declared with empty brackets after the name of the type or the name of the array itself. These two declarations are equivalent:

```
int[] a;
```

and

```
int a[];
```

A declaration of a basic data type also creates an item of the specified type. As for all objects, an array declaration does not create an array. An array can be created with the operator `new`, and very often declaration and initialization are combined, as in

```
int[] a = new int[10];
```

This creates an array of 10 cells that are indexed with numbers 0 through 9; that is, the first cell is `a[0]` and the last cell `a[9]`. An array can also be created by specifying the value of its cells,

```
int[] b = {5, 4, 2, 1};
```

which creates a four-cell array of integers.

Unlike C/C++, it is impossible to access a cell that is out of bounds. An attempt to do so, as with the assignment

```
a[10] = 5;
```

results in a run-time error `ArrayIndexOutOfBoundsException`. To avoid this, the length of the array can be checked before performing an assignment with the variable `length` associated with each array, `a.length`.

Note that for arrays, `length` is a variable, not a method, as is the case for strings; therefore, `a.length()` would be an error.

Because arrays are objects, two array variables can refer to the same array:

```
int[] a1 = new int[3], a2 = a1;
a1[0] = 12;
System.out.println(a2[0]); // print 12
```

Arrays are passed to methods by reference; that is, changes performed in a method that takes an array parameter affects the array permanently. For example, if a method for doubling values in integer arrays is defined:

```
public void doubleArray(int[] a) {
    for (int i = 0; i < a.length; i++)
        a[i] += a[i];
}
```

then the following code

```
a1[1] = a1[2] = 13;
doubleArray(a1);
for (int i = 0; i < a1.length; i++)
    System.out.print(a1[i] + " ");
```

results in printing numbers 24, 26, and 26.

In Java 1.2, the class `Arrays` is added with several useful methods to be applied to arrays, in particular `binarySearch()`, `equals()`, `fill()`, and `sort()`. For example, to sort an array, it is enough to import class `java.util.Arrays` and execute one of the versions of the method `sort`, for example,

```
Arrays.sort(a);
```

#### 1.2.1.4 Wrapper Classes

Except for basic data types, everything in Java is an object. For this reason, many classes in the `java.util` package operate on items of type `Object`. To include basic data types in this category so that the utility classes can also operate on them, the so-called wrapper classes are introduced to provide object versions of basic data types. For example, the `Integer` class is an object wrapper for the type `int`. The class provides several methods. The `Integer` class includes the following methods: `getInteger()` to convert a string into an `Integer`, `parseInt()` to convert a string into an `int`, `convert()` to convert a string into a number when the radix is not known, `toString()` to convert an integer into a string, and a sequence of methods to convert an integer into other basic types: `intValue()`, `longValue()`, and so on.

## 1.2.2 Abstract Data Types

Before a program is written, the programmer should have a fairly good idea of how to accomplish the task being implemented by the program. Hence, an outline of the program containing its requirements should precede the coding process. The larger and more complex the project, the more detailed the outline phase should be. The implementation details should be delayed to the later stages of the project. In particular, the details of the particular data structures to be used in the implementation should not be specified at the beginning.

From the start, it is important to specify each task in terms of input and output. At the beginning stages, we should be more concerned with what the program should do, not how it should or could be done. Behavior of the program is more important than the gears of the mechanism accomplishing it. For example, if an item is needed to accomplish some tasks, the item is specified in terms of operations performed on it rather than in terms of its inner structure. These operations may act upon this item by modifying it, searching for some details in it, or storing something in it. After these operations are precisely specified, the implementation of the program may start. The implementation decides which data structure should be used to make execution most efficient in terms of time and space. An item specified in terms of operations is called an *abstract data type*. In Java, an abstract data type can be part of a program in the form of an interface.

Interfaces, successors of protocols in Objective-C, are similar to classes, but they can contain only constants (*final* variables) and method prototypes or signatures; that is, specifications of method names, types of parameters, and types of return values. Declarations in an interface are public, and data are final even if they are not labeled. Methods are thus not defined, and the task of defining methods is passed to a class that *implements* an interface (that is, implements as public all the methods listed in the interface). One class can implement more than one interface, the same interface can be implemented by more than one class, and the classes implementing one interface do not have to be related in any way to each other. Therefore, at the first stage of program design, interfaces can be specified, and the specifics of implementation of their methods are left until later for the implementation classes. And because an interface can extend another interface, a top-down design can become part of the program in a very natural way. This allows the program developer to concentrate first on big issues when designing a program, but also allows a user of a particular implementation of an interface to be certain that all the methods listed in the interface are implemented. In this way, the user is assured that no method listed in the interface is left out in any of the implementation classes, and all instances of implementation classes respond to the same method calls.

The rigidity of interfaces is somewhat relaxed in abstract classes. A class declared **abstract** can include defined methods; that is, not only method signatures, but also method bodies. A method that is specified only by its signature must also be declared as **abstract**. A class can make an abstract class specific by extending it. Here is an example:

```
interface I {
    void If1(int n);
    final int m = 10;
}
class A implements I {
    public void If1(int n) {
        System.out.println("AIf1 " + n*m);
    }
}
abstract class AC {
    abstract void ACf1(int n);
    void ACf2(int n) {
        System.out.println("ACf2 " + n);
    }
}
class B extends AC {
    public void ACf1(int n) {
        System.out.println("BACf1 " + n);
    }
}
```

### 1.2.3 Inheritance

OOLs allow for creating a hierarchy of classes so that objects do not have to be instantiations of a single class. Before discussing the problem of inheritance, consider the following class definitions:

```
package basePackage;

class BaseClass {
    public BaseClass() {
    }
    public void f(String s) {
        System.out.println("Method f() in BaseClass called from " + s);
        h("BaseClass");
    }
    protected void g(String s) {
        System.out.println("Method g() in BaseClass called from " + s);
    }
    private void h(String s) {
        System.out.println("Method h() in BaseClass called from " + s);
    }
    void k(String s) {
        System.out.println("Method k() in BaseClass called from " + s);
    }
}
```

A file `BaseClass.java` is in a subdirectory `basePackage`. The directory in which this subdirectory is located contains the file `testInheritance.java`, which contains the following classes:

```
class Derived1Level1 extends BaseClass {
    public void f(String s) {
        System.out.println("Method f() in Derived1Level1 called from " + s);
        g("Derived1Level1");
    }
    public void h(String s) {
        System.out.println("Method h() in Derived1Level1 called from " + s);
    }
    void k(String s) {
        System.out.println("Method k() in Derived1Level1 called from " + s);
    }
}

class Derived2Level1 extends BaseClass {
    public void f(String s) {
        System.out.println("Method f() in Derived2Level1 called from " + s);
        // h("Derived2Level1"); // h() has private access in basePackage.BaseClass.
    }
}
```

```

//      k("Derived2Level1"); // k() is not public in basePackage.BaseClass;
//                                // cannot be accessed from outside package.
    }
    protected void g(String s) {
        System.out.println("Method g() in Derived2Level1 called from " + s);
    }
}
class DerivedLevel2 extends Derived1Level1 {
    public void f(String s) {
        System.out.println("Method f() in DerivedLevel2 called from " + s);
        g("DerivedLevel2");
        h("DerivedLevel2");
        k("DerivedLevel2");
        super.f("DerivedLevel2");
    }
}
class TestInheritance {
    void run() {
        BaseClass bc = new BaseClass();
        Derived1Level1 d111 = new Derived1Level1();
        Derived2Level1 d211 = new Derived2Level1();
        DerivedLevel2 dl2 = new DerivedLevel2();
        bc.f("main(1)");
//      bc.g("main(2)"); // g() has protected access in basePackage.BaseClass.
//      bc.h("main(3)"); // h() has private access in basePackage.BaseClass.
//      bc.k("main(4)"); // k() is not public in basePackage.BaseClass;
//                                // cannot be accessed from outside package.

        d111.f("main(5)");
//      d111.g("main(6)"); // g() has protected access in basePackage.BaseClass.
        d111.h("main(7)");
        d111.k("main(8)");
        d211.f("main(9)");
        d211.g("main(10)");
//      d211.h("main(11)"); // h() has private access in basePackage.BaseClass.
        dl2.f("main(12)");
//      dl2.g("main(13)"); // g() has protected access in basePackage.BaseClass.
        dl2.h("main(14)");
    }
    public static void main(String args[]) {
        (new TestInheritance()).run();
    }
}

```

The execution of this code generates the following output:

```

Method f() in BaseClass called from main(1)
Method h() in BaseClass called from BaseClass
Method f() in Derived1Level1 called from main(5)
Method g() in BaseClass called from Derived1Level1
Method h() in Derived1Level1 called from main(7)
Method k() in Derived1Level1 called from main(8)
Method f() in Derived2Level1 called from main(9)
Method g() in Derived2Level1 called from main(10)
Method f() in DerivedLevel2 called from main(12)
Method g() in BaseClass called from DerivedLevel2
Method h() in Derived1Level1 called from DerivedLevel2
Method k() in Derived1Level1 called from DerivedLevel2
Method f() in Derived1Level1 called from DerivedLevel2
Method g() in BaseClass called from Derived1Level1
Method h() in Derived1Level1 called from main(14)

```

The class `BaseClass` is called a *base class* or a *superclass*, and other classes are called *subclasses* or *derived classes* because they are derived from the superclass in that they can use the data fields and methods specified in `BaseClass` as `protected`, `public`, or—when subclasses are in the same package as the base class—have no access modifier. They inherit all these fields and methods from their base class so that they do not have to repeat the same definitions. However, a derived class can override the definition of a non-`final` method by introducing its own definition. In this way, both the base class and the derived class have some measure of control over their methods.

The base class can decide which methods and data fields can be revealed to derived classes so that the principle of information hiding holds not only with respect to the user of the base class, but also to the derived classes. Moreover, the derived class can decide which `public` and `protected` methods and data fields to retain and use and which to modify. For example, both `Derived1Level1` and `Derived2Level1` redefine method `f()` by giving their own versions of `f()`. However, the access to the method with the same name in the parent class is still possible by preceding the method name with the keyword `super`, as shown in the call of `super.f()` from `f()` in `DerivedLevel2`.

A derived class can add new methods and fields of its own. Such a class can become a base class for other classes that can be derived from it so that the inheritance hierarchy can be deliberately extended. For example, the class `Derived1Level1` is derived from `BaseClass`, but at the same time, it is the base class for `DerivedLevel2`.

`Protected` methods or fields of the base class are accessible to derived classes. They are also accessible to nonderived classes if these classes are in the same package as the class that defines the `protected` methods and fields. For this reason, `Derived1Level1` can call `BaseClass`'s `protected` method `g()`, but a call to this method from `run()` in `TestInheritance` is rendered illegal.

However, `run()` can call method `g()`, declared `protected` in `Derived2Level1`, because both `Derived2Level1` and `TestInheritance` in which `run()` is defined are in the same package.

Methods and data fields with no access modifier can be accessed by any class in the same package. For example, the method `k()` in `BaseClass` cannot be accessed even in a derived class, `Derived2Level1`, because the derived class is in a different package. But the method `k()` in `Derived1Level1` can be accessed even in a non-derived class, such as `TestInheritance` in `run()`, because both `Derived1Level1` and `TestInheritance` are in the same package.

Unlike C++, which supports multiple inheritance, inheritance in Java has to be limited to one class only so that it is not possible to declare a new class with the declaration

```
class Derived2Level2 extends Derived1Level1, Derived2Level1 { ... }
```

In addition, a class declared `final` cannot be extended (the wrapper classes are examples of `final` classes).

## 1.2.4 Polymorphism

Polymorphism refers to the ability of acquiring many forms. In the context of OOP, this means that the same method name denotes many methods that are members of different objects. This is accomplished by so-called *dynamic binding*, when the type of a method to be executed can be delayed until run time. This is distinguished from *static binding*, when the type of response is determined at compilation time, as in the case of the `IntObject` and `DoubleObject` presented in Section 1.2.1. Both of these objects are declared as objects whose storage fields hold data of type `Object` and not `integer` or `double`. The conversion is performed dynamically, but outside the object itself. For dynamic binding, consider the following declarations:

```
class A {
    public void process() {
        System.out.println("Inside A");
    }
}
class ExtA extends A {
    public void process() {
        System.out.println("Inside ExtA");
    }
}
```

then the code

```
A object = new A();
object.process();
object = new ExtA();
object.process();
```

results in the output

```
Inside A
Inside ExtA
```

This is due to dynamic binding: The system checks dynamically the type of object to which a variable is currently referring and chooses the method appropriate for this type. Thus, although the variable `object` is declared to be of type `A`, it is assigned in the second assignment an object of type `ExtA` and executes the method `process()`, which is defined in class `ExtA`, rather than the method by the same name defined in class `A`.

This is also true for interfaces. For example, if the declarations

```
interface B {
    void process();
}
class ImplB1 implements B {
    public void process() {
        System.out.println("Inside ImplB1");
    }
}
class ImplB2 implements B {
    public void process() {
        System.out.println("Inside ImplB2");
    }
}
```

are followed by the statements

```
B object = new ImplB1();
object.process();
object = new ImplB2();
object.process();
```

then the output is

```
Inside ImplB1
Inside ImplB2
```

notwithstanding the fact that `object` is of type `B`. The system recognizes that, for the first call of `process()`, `object` refers to an object of type `ImplB1`, and in the second call, it refers to an object of type `ImplB2`.

Polymorphism is thus a powerful tool in OOP. It is enough to send a standard message to many different objects without specifying how the message will be followed. There is no need to know of what type the objects are. The receiver is responsible for interpreting the message and following it. The sender does not have to modify the message depending on the type of receiver. There is no need for `switch` or `if-else` statements. Also, new units can be added to a complex program without the need of recompiling the entire program.

Dynamic binding allows for empowering the definition of `GenClass`. Assume that the definition of this class also includes a method for finding a position of a particular piece of information. If the information is not found, `-1` is returned. The definition is now



```

class GenClass {
    Object[] storage = new Object[50];
    int find(Object e1) {
        for (int i = 0; i < 50; i++)
            if (storage[i] != null && storage[i].equals(e1))
                return i;
        return -1;
    }
    void store(Object e1) {
        . . . . .
    }
    . . . . .
}

```

The method `find()` returns the correct result if wrappers of basic types are used—`Character()`, `Integer()`, and so on—but what happens if we want to store non-standard objects in an instance of `GenClass`? Consider the following declaration

```

class SomeInfo {
    SomeInfo (int n) {
        this.n = n;
    }
    private int n;
}

```

Now the problem is, what happens if for a declaration

```
GenClass object = new GenClass();
```

we execute:

```

object.store(new SomeInfo(17));
System.out.println(object.find(new SomeInfo(17)));

```

As it turns out, `-1` is printed to indicate an unsuccessful search. The result is caused by the method `equals()`. The system is using a built-in method for type `Object` that returns true if *references* of the compared variables are the same, not the *contents* of objects to which they refer. To overcome this limitation, the method `equals()` must be redefined by overriding the standard definition by a new definition. Therefore, the definition of `SomeInfo` is incomplete, and should be extended to

```

class SomeInfo {
    SomeInfo (int n) {
        this.n = n;
    }
    public boolean equals(Object si) {
        return n == ((SomeInfo) si).n;
    }
    private int n;
}

```

With this new definition, `find()` returns the position of the object holding number 17. The reason this works properly is that all classes are extensions of the class `Object`. This extension is done implicitly by the system so that the declaration of `SomeInfo` is really

```
class SomeInfo extends Object {
    . . . . .
}
```

The qualifier `extends Object` is understood in the original definition and does not have to be made explicit. In this way, the standard method `equals()` is overridden by redefinition of this method in the class `SomeInfo` and by the power of dynamic binding. When executing the call `object.find(new SomeInfo(17))`, the system uses the method `equals()` defined in the class `SomeInfo` because an instance of this class is an argument in the method call. Thus, inside `find()`, the local variable becomes a reference to an object of type `SomeInfo`, although it is defined as a parameter of type `Object`. The problem is, however, that such a quick adjustment can be done only for the built-in methods for `Object`, in particular, `equals()` and `toString()`. Only slightly more complicated is the case when we want to define a generic class that makes comparisons possible. A more realistic example of polymorphism is given in the case study.

## 1.3

## INPUT AND OUTPUT

The `java.io` package provides several classes for reading and writing data. To use the classes, the package has to be explicitly included with the statement

```
import java.io.*;
```

In this section, we briefly introduce classes for reading from a standard device (keyboard), writing to a standard device (monitor), and processing I/O on files. There are also a number of other classes that are particularly important for interacting with the network, such as buffered, filtered, and piped streams.

To print anything on the screen, two statements are sufficient:

```
System.out.print(message);
System.out.println(message);
```

The two statements differ in that the second version outputs the end-of-line character after printing a message. The message printed by the statement is a string. The string can be composed of literal strings, string variables, and strings generated by the method `toString()` for a particular object; all components of the print statement are concatenated with the operator `+`. For example, having declared the class `C`:

```
class C {
    int i = 10;
    char a = 'A';
    public String toString() {
        return "(" + i + " " + a + " ";
    }
}
```

and an object

```
C obj = new C();
```

a printing statement

```
System.out.println("The object: " + obj);
```

outputs

```
The object: (10 A)
```

Note that if `toString()` were not defined in `C`, the output would be

```
The object: C@1cc789
```

because class `C` is by default an extension of the class `Object` whose method `toString()` prints the address of a particular object. Therefore, it is almost always critical that `toString()` is redefined in a user class to have a more meaningful output than an address.

Reading input is markedly more cumbersome. Data are read from standard input with the input stream `System.in`. To that end, the method `read()` can be used, which returns an integer. To read a line, the user must define a new method, for example,

```
public String readLine() {
    int ch;
    String s = "";
    while (true) {
        try {
            ch = System.in.read();
            if (ch == -1 || (char)ch == '\n') //end of file or end of line;
                break;
            else if ((char)ch != '\r') // ignore carriage return;
                s = s + (char)ch;
        } catch(IOException e) {
        }
    }
    return s;
}
```

Because `read()` is defined as a method that throws an `IOException`, the exception has to be handled with the `try-catch` clause.

Note that `ch` must be an integer to detect the end of file (which is Ctrl-z entered from the PC keyboard). The end-of-field marker is the number `-1`, and characters are really unsigned integers. If `ch` were declared as a character, then the assignment statement would have to be

```
ch = (char) System.in.read();
```

with which the end-of-line marker `-1` would be stored as number `65535` in `ch`, whereby the subcondition `ch == -1` would be evaluated to false and the system would wait for further input.

Fortunately, the task can be accomplished differently by first declaring an input stream with the declarations:

```
InputStreamReader cin = new InputStreamReader(System.in);
BufferedReader br = new BufferedReader(cin);
```

or with one declaration:

```
BufferedReader br = new BufferedReader(new InputStreamReader(System.in));
```

and then a built-in method `readLine()` can be called to assign a value to a string `s`:

```
try {
    s = br.readLine();
} catch (IOException e) {
}
```

To read a number, an input must be read as a string and then converted into a number. For example, if input is in string `s`, then the conversion can be performed with

```
try {
    i = Integer.parseInt(s.trim());
} catch (NumberFormatException e) {
    System.out.println("Not a number");
}
```

Input can be simplified after `javax.swing.JOptionPane` is imported:

```
String s = JOptionPane.showInputDialog("Enter a number");
i = Integer.parseInt(s.trim());
```

To perform input and output on a file, a decision has to be made as to what type of data are to be processed so that the proper type of file can be elected.

A binary file is processed as a sequence of bytes, a text file as a sequence of characters. Generally, text files are portable; binary files are not because the data in the file have the same representation as data stored in main memory, and this representation varies from one system to another. However, Java binary files are platform independent.

The `java.io` package includes many streams for performing I/O that are organized in a hierarchy. The `InputStream` and `OutputStream` classes are used for processing binary files, and the `Reader` and `Writer` classes are for text files.

### 1.3.1 Reading and Writing Bytes

Consider a method that reads one byte at a time from an input file and writes it into an output file and to the screen:

```
void readBytes1(String fInName, String fOutName) throws IOException {
    FileInputStream fIn = new FileInputStream(fInName);
    FileOutputStream fOut = new FileOutputStream(fOutName);
    int i;
    while ((i = fIn.read()) != -1) {
```

```

        System.out.print((char)i + " "); // display characters;
// System.out.print(i + " ");        // display ASCII values;
        fOut.write(i);
    }
    fIn.close();
    fOut.close();
}

```

An integer variable is used to read the input, and the end of file is indicated by `-1`. To make reading and writing more efficient, input and output are buffered:

```

void readBytes2(String fInName, String fOutName) throws IOException {
    BufferedInputStream fIn = new BufferedInputStream(
        new FileInputStream(fInName));
    BufferedOutputStream fOut = new BufferedOutputStream(
        new FileOutputStream(fOutName));

    int i;
    while ((i = fIn.read()) != -1) {
        System.out.print(i + " ");
        fOut.write(i);
    }
    fIn.close();
    fOut.close();
}

```

### 1.3.2 Reading Lines

To read one line at a time, the method `readLine()` from `BufferedReader` is used, as in this example:

```

void readLines(String fInName, String fOutName) throws IOException {
    BufferedReader fIn = new BufferedReader(
        new FileReader(fInName));
    PrintWriter fOut = new PrintWriter(new FileWriter(fOutName));
    String s;
    while ((s = fIn.readLine()) != null) {
        System.out.println(s);
        fOut.println(s);
    }
    fIn.close();
    fOut.close();
}

```

The end of file is detected upon reading a null string (after reading an empty line, the string `s` is not null, but is of length 0).

### 1.3.3 Reading Tokens: Words and Numbers

A `StreamTokenizer` extracts from a text file various types of tokens including identifiers (sequences of letters and digits that begin with a letter or a byte from the range '\u00A0' through '\u00FF') and numbers. It can also extract quoted strings and various comment styles when the tokenizer is properly set up. The `nextToken()` method skips space characters separating tokens and updates the tokenizer's instance variables: `sval` of type `String`, which contains the current token when it is a word; `nval` of type `double`, which contains the current token when it is a number; and `ttype` of type `int`, which contains the type of the current token. There are four types of tokens: `TT_EOF` (end of file), `TT_EOL` (end of line), `TT_WORD`, and `TT_NUMBER`. Here is an example:

```
void readTokens(String fName) throws IOException {
    StreamTokenizer fIn = new StreamTokenizer(
        new BufferedReader(
            new FileReader(fInName)));

    fIn.nextToken();
    String s;
    while (fIn.ttype != StreamTokenizer.TT_EOF) {
        if (fIn.ttype == StreamTokenizer.TT_WORD)
            s = "word";
        else if (fIn.ttype == StreamTokenizer.TT_NUMBER)
            s = "number";
        else s = "other";
        System.out.println(s + ":\t" + fIn);
        fIn.nextToken();
    }
}
```

When a text file consists of words or numbers separated by blanks, then it may be easier to extract each word or number by reading one line at a time and then applying a string tokenizer, as in

```
void readTokens2(String fName) throws IOException {
    BufferedReader fIn = new BufferedReader(
        new FileReader(fInName));

    String s;
    while ((s = fIn.readLine()) != null) {
        java.util.StringTokenizer line = new java.util.StringTokenizer(s);
        while (line.hasMoreTokens())
            System.out.println(line.nextToken());
    }
    fIn.close();
}
```

Another example of applying a stream tokenizer can be found in Section 5.11.

### 1.3.4 Reading and Writing Primitive Data Types

The `DataInputStream` class provides methods for reading primitive data types in binary format. The methods include `readBoolean()`, `readByte()`, `readShort()`, `readChar()`, `readInt()`, `readLong()`, and `readUTF()` (to read strings in Unicode Text Format).

```
void writePrimitives(String fOutName) throws IOException {
    DataOutputStream fOut = new DataOutputStream(
        new FileOutputStream(fOutName));
    fOut.writeBoolean(5<6);
    fOut.writeChar('A');
    fOut.writeDouble(1.2);
    fOut.writeFloat(3.4f);
    fOut.writeShort(56);
    fOut.writeInt(78);
    fOut.writeLong(90);
    fOut.writeByte('*');
    fOut.writeUTF("abc");
    fOut.close();
}

void readPrimitives(String fInName) throws IOException {
    DataInputStream fIn = new DataInputStream(
        new FileInputStream(fInName));
    System.out.println(fIn.readBoolean() + " " +
        fIn.readChar() + " " +
        fIn.readDouble() + " " +
        fIn.readFloat() + " " +
        fIn.readShort() + " " +
        fIn.readInt() + " " +
        fIn.readLong() + " " +
        fIn.readByte() + " " +
        fIn.readUTF());
    fIn.close();
}
```

The case study at the end of the chapter relies on the I/O for primitive data types.

### 1.3.5 Reading and Writing Objects

Objects can also be saved in a file if they are made persistent. An object becomes persistent if its class type is stated to implement the `Serializable` interface, as in

```
class C implements Serializable {
    int i;
    char ch;
    C(int j, char c) {
```

```

        i = j; ch = c;
    }
    public String toString() {
        return "(" + i + " " + ch + ")";
    }
}

```

Such a declaration is possible if all instance variables are also `Serializable`, which is the case for class `C`, because in Java all basic data types, arrays, and many classes are `Serializable`. Here is an example of writing and reading an object of class type `C`:

```

void writeObjects(String fOutName) throws IOException {
    C c1 = new C(10, 'A'), c2 = new C(20, 'B');
    ObjectOutputStream fOut = new ObjectOutputStream(
        new FileOutputStream(fOutName));

    fOut.writeObject(c1);
    fOut.writeObject(c2);
    fOut.close();
}

void readObjects(String fInName) throws IOException {
    C c1 = new C(30, 'C'), c2 = c1;
    ObjectInputStream fIn = new ObjectInputStream(
        new FileInputStream(fInName));

    try {
        c1 = (C)fIn.readObject();
        c2 = (C)fIn.readObject();
    } catch(ClassNotFoundException e) {
    }
    System.out.println(c1 + " " + c2);
}

```

### 1.3.6 Random Access Files

The files discussed thus far are processed sequentially: We read (write) one item at a time and proceed toward the end of the file. To be able to both read and write in the same file at any position in the file, a random access file should be used. A file is created with the constructor

```
RandomAccessFile(name, mode);
```

The constructor opens a file with the specified name either for reading only or for reading and writing. The mode is specified by either the letter *w* or the letters *rw*; for instance,

```
RandomAccessFile raf = new RandomAccessFile("myFile", "rw");
```

We can move anywhere in the file, but to know that we are within the file, we can use the method `length()` that returns the size of the file measured in bytes. The method `getFilePointer()` returns the current position in the file. The method `seek(pos)` moves the file pointer to the position specified by an integer `pos`.



Reading is done by the method `read()`, which returns a byte as an integer; by `read(b)`, which fills entirely a byte array `b`; by `read(b,off,len)`, which fills `len` cells of the byte array `b` starting from cell `off`; and by `readLine()`, which reads one line of input. Other reading methods return a value specified by their names: `readBoolean()`, `readByte()`, `readShort()`, `readChar()`, `readInt()`, `readLong()`, and `readUTF()`. All of these reading methods have corresponding writing methods, for example, `write(c)`, where `c` is an `int`, `write(b)`, and `write(b,off,len)`, plus the method `writeBytes(s)` to write a string `s` as a sequence of bytes.

After file processing is finished, the file should be closed with the `close()` method:

```
raf.close();
```

Examples of the application of random access files can be found in the Case Study in Section 1.7.

## 1.4

## JAVA AND POINTERS

In this section, a problem of implementing Java objects is analyzed.

Although Java does not use explicit pointers and does not allow the programmer to use them, object access is implemented in terms of pointers. An object occupies some memory space starting from a certain memory location. A pointer to this object is a variable that holds the address of the object, and this address is the starting position of the object in memory. In many languages, *pointer* is a technical term for a type of variable; therefore, the term is avoided in discussing Java programs and usually the term *reference* is used instead.

Consider the following declarations:

```
class Node {
    String name;
    int age;
}
```

With declarations

```
Node p = null, q = new Node("Bill",20);
```

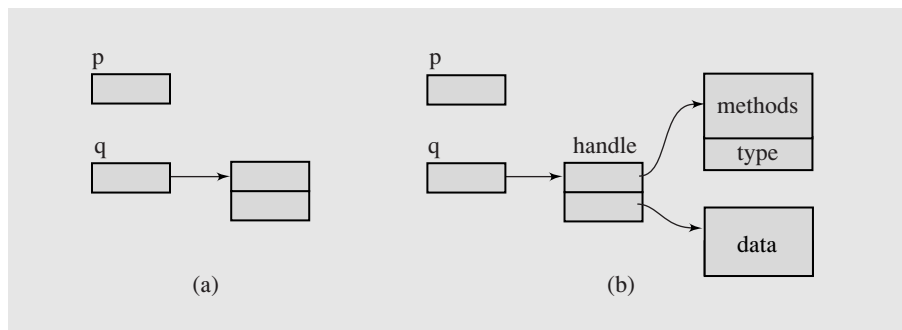
two reference variables are created, `p` and `q`. The variable `p` is initialized to `null`. The pointer `null` does not point anywhere. It is not able to point to any object of any type; therefore, `null` is compatible with and can be assigned to a reference variable of any type. After execution of the assignment

```
p = null;
```

we may not say that `p` refers to `null` or points to `null`, but that `p` becomes `null` or `p` is `null`. The variable `p` is created to be used in the future as a reference to an object, but currently, it does not refer to any. The variable `q` is a reference to an object that is an instance of class `Node`. Forced by the built-in method `new`, the operating system through its memory manager allocates enough space for one unnamed object that can be

accessed, for now, only through the reference variable `q`. This reference is a pointer to the address of the memory chunk allocated for the object just created, as shown in Figure 1.1a. Figure 1.1a represents the logic of object reference, whose implementation can vary from one system to another and is usually much more intricate than the simple logic presented in this figure. For example, in Sun's implementation of Java, `q` refers to a handle that is a pair of pointers: one to the method table of the object and its type (which is a pointer to the class whose instance the object is) and the other to the object's data (Figure 1.1b). In Microsoft's implementation, `q` refers to the object's data, and the type and method table are pointed to by a hidden field of the object `q`. For simplicity, the subsequent illustrations use the form reflecting the logic of object reference, as in Figure 1.1a.

**FIGURE 1.1** Object reference variables `p` and `q`: (a) logic of reference of `q` to an object; (b) implementation of this reference.



Keeping in mind how object access is implemented in Java helps explain the results of reference comparisons in Java. Consider the following code:

```
p = new Node("Bill", 20);
System.out.print(p == q);
```

The printing statement outputs `false` because we compare references to two different objects; that is, we compare two different references (addresses), not the objects. To compare the objects' contents, their data fields have to be compared one by one using a method defined just for this reason. If `Node` includes the method

```
public boolean equals(Node n) {
    return name.equals(n.name) && age == n.age;
}
```

then the printing statement

```
System.out.print(p.equals(q));
```

outputs `true`. (This can be accomplished much more elegantly in C++ by overloading the equality operator `==`; that is, by defining a method that allows for application of this operator to instances of class `Node`.)

The realization that object variables are really references to objects helps explain the need for caution with the use of the assignment operator. The intention of the declarations

```
Node node1 = new Node("Roger",20), node2 = node1;
```

is to create object `node1`, assign values to the two fields in `node1`, and then create object `node2` and initialize its fields to the same values as in `node1`. These objects are to be independent entities so that assigning values to one of them should not affect values in the other. However, after the assignments

```
node2.name = "Wendy";
node2.age = 30;
```

the printing statement

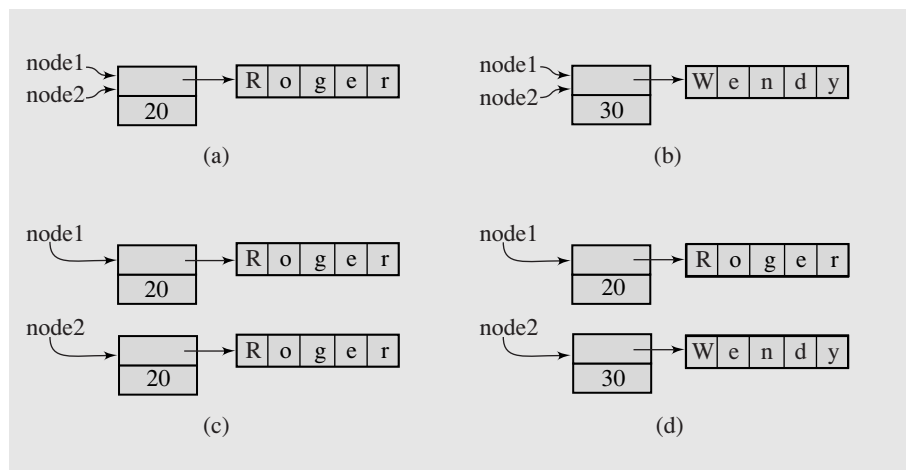
```
System.out.println(node1.name+" "+node1.age+" "+node2.name+" "+ node2.age);
```

generates the output

```
Wendy 30 Wendy 30
```

Both the ages and names in the two objects are the same. What happened? Because `node1` and `node2` are pointers, the declarations of `node1` and `node2` result in the situation illustrated in Figure 1.2a. After the assignments to the two fields of `node1`, the situation is as in Figure 1.2b. To prevent this from happening, we have to create a new copy of the object referenced by `node1` and then make `node2` become a

**FIGURE 1.2** Illustrating the necessity of using the method `clone()`.



reference to this copy. This can be done by defining the method `clone()` marked in the interface `Cloneable`. A new definition of `Node` is now:

```
class Node implements Cloneable {
    String name;
    int age;
    Node(String n, int a) {
        name = n; age = a;
    }
    Node() {
        this("",0);
    }
    public Object clone() {
        return new Node(name,age);
    }
    public boolean equals(Node n) {
        return name.equals(n.name) && age == n.age;
    }
}
```

With this definition, the declarations should be

```
Node node1 = new Node("Roger",20), node2 = (Node) node1.clone();
```

which results in the situation shown in Figure 1.2c, so that the two assignments

```
node2.name = "Wendy";
node2.age = 30;
```

affect only the second object (Figure 1.2d).

The Java pointers are screened from the programmer. There is no pointer type in Java. The lack of an explicit pointer type is motivated by the desire to eliminate harmful behavior of programs. First, it is not possible in Java to have a nonnull reference to a nonexistent object. If a reference variable is not null, it always points to an object because the programmer cannot destroy an object referenced by a variable. An object can be destroyed in Pascal through the use of the function `dispose()` and in C++ through `delete`. The reason for using `dispose()` or `delete` is the need to return to the memory manager memory space occupied by an unneeded object. Directly after execution of `dispose()` or `delete`, pointer variables hold addresses of objects already returned to the memory manager. If these variables are not set to null or to the address of an object accessible from the program, the so-called *dangling reference problem* arises, which can lead to a program crash. In Java, the dangling reference problem does not arise. If a reference variable `p` changes its reference from one object to another, and the old object is not referenced by any other variable `q`, then the space occupied by the object is reclaimed automatically by the operating system through garbage collection (see Chapter 12). There is no equivalent in Java of `dispose()` or `delete`. Unneeded objects are simply abandoned and included in the pool of free memory cells automatically by the garbage collector during execution of the user program.

Another reason for not having explicit pointers in Java is a constant danger of having a reference to a memory location that has nothing to do with the logic of the program. This would be possible through the pointer arithmetic that is not allowed in Java, where such assignments as

```
(p + q).ch = 'b';
(++p).n = 6;
```

are illegal.

Interestingly, although explicit pointers are absent in Java, Java relies on pointers more heavily than C/C++. An object declaration is always a declaration of reference to an object; therefore, an object declaration

```
Node p;
```

should be followed by initializing the variable `p` either by explicitly using a constructor, as in

```
p = new Node();
```

or by assigning a value from an already initialized variable, as in

```
p = q;
```

Because an array is also an object, the declaration

```
int a[10];
```

is illegal; this declaration is considered an attempt to define a variable whose name is `a[10]`. A declaration has to be followed with initialization, which is often combined with the declaration, as in

```
int[] a = new int[10];
```

In this way, Java does not allow for variables that name objects directly. Thus, the dot notation used to access fields of the object, as in `p.name`, is really an indirect reference to the field name because `p` is not the name of the object with field `name`, but a reference to (address of) this object. Fortunately, the programmer does not have to be very concerned about this distinction because it is all a matter of language implementation. But as mentioned, an understanding of these implementation details helps explain the results of some operations, as illustrated earlier by the operator `==`.

## 1.5 VECTORS IN `java.util`

A useful class in the `java.util` package is the class `Vector` although it is considered today to be a legacy class. A vector is a data structure with a contiguous block of memory, just like an array. Because memory locations are contiguous, they can be randomly accessed so that the access time of any element of the vector is constant. Storage is managed automatically so that on an attempt to insert an element into a full vector, a larger memory block is allocated for the vector, the vector elements are copied to the new block, and the old block is released. `Vector` is thus a flexible array; that is, an array whose size can be dynamically changed.

The class hierarchy in the package `java.util` is as follows:

`Object` ⇒ `AbstractCollection` ⇒ `AbstractList` ⇒ `Vector`

Figure 1.3 lists alphabetically the methods of class `Vector`. Some of these methods are inherited from `AbstractList`; others are from `AbstractCollection`. Figure 1.3 lists most of the methods of the class. Only methods `iterator()` and `listIterator()`, inherited from class `AbstractList`, and methods `finalize()`, `getClass()`, `notify()`, `notifyAll()`, and `wait()`, inherited from class `Object`, are not included.

**FIGURE 1.3** An alphabetical list of member functions in the class `java.util.Vector`.

Method	Operation
<code>void add(Object ob)</code>	insert object <code>ob</code> at the end of the vector
<code>void add(int pos, Object ob)</code>	insert object <code>ob</code> at position <code>pos</code> after shifting elements at positions following <code>pos</code> by one position; throw <code>ArrayIndexOutOfBoundsException</code> if <code>pos</code> is out of range
<code>boolean addAll(Collection c)</code>	add all the elements from the collection <code>c</code> to the end of the vector; return <code>true</code> if <code>c</code> is not empty; throw <code>ArrayIndexOutOfBoundsException</code> if <code>pos</code> is out of range and <code>NullPointerException</code> if <code>c</code> is null
<code>boolean addAll(int pos, Collection c)</code>	add all the elements from the collection <code>c</code> at the position <code>pos</code> of the vector after shifting the objects following position <code>pos</code> ; throw <code>ArrayIndexOutOfBoundsException</code> if <code>pos</code> is out of range and <code>NullPointerException</code> if <code>c</code> is null
<code>void addElement(Object ob)</code>	insert object <code>ob</code> at the end of the vector; same as <code>add(ob)</code>
<code>int capacity()</code>	return the number of objects that can be stored in the vector
<code>void clear()</code>	remove all the objects from the vector
<code>Object clone()</code>	return a clone of the vector
<code>boolean contains(Object ob)</code>	return <code>true</code> if the vector contains the object <code>ob</code>
<code>boolean containsAll(Collection c)</code>	return <code>true</code> if the vector contains all of the objects in the collection <code>c</code> ; throw <code>NullPointerException</code> if <code>c</code> is null
<code>void copyInto(Object a[])</code>	copy objects from the vector to the object array <code>a</code> ; throw <code>IndexOutOfBoundsException</code> if the array is not large enough to accommodate all objects from the vector and <code>NullPointerException</code> if <code>a</code> is null

**FIGURE 1.3** (continued)

<code>Object elementAt(int pos)</code>	return the object at position <code>pos</code> ; throw <code>ArrayIndexOutOfBoundsException</code> if <code>pos</code> is out of range; same as <code>get(pos)</code>
<code>Enumeration elements()</code>	return an <code>Enumeration</code> object that enumerates all the objects in the vector
<code>void ensureCapacity(int minCap)</code>	extend the size of the vector to accommodate at least <code>minCap</code> objects; do nothing if the size of the vector exceeds the minimum capacity <code>minCap</code>
<code>boolean equals(Object v)</code>	return <code>true</code> if the current vector and object <code>v</code> contain equal objects in the same order
<code>Object firstElement()</code>	return the first element in the vector; throw <code>NoSuchElementException</code> if the vector is empty
<code>Object get(int pos)</code>	return the object at position <code>pos</code> ; throw <code>ArrayIndexOutOfBoundsException</code> if <code>pos</code> is out of range
<code>int hashCode()</code>	return the hash code for the vector
<code>int indexOf(Object ob)</code>	return the position of the first occurrence of object <code>ob</code> in the vector; return <code>-1</code> if <code>ob</code> is not found
<code>int indexOf(Object ob, int pos)</code>	return the position of the first occurrence of object <code>ob</code> in the vector beginning the search at position <code>pos</code> ; return <code>-1</code> if <code>ob</code> is not found; throw <code>IndexOutOfRangeException</code> if <code>pos &lt; 0</code>
<code>void insertElementAt(Object ob, int pos)</code>	insert object <code>ob</code> at position <code>pos</code> after shifting elements at positions following <code>pos</code> by one position; throw <code>ArrayIndexOutOfBoundsException</code> if <code>pos</code> is out of range; same as <code>add(ob, pos)</code>
<code>boolean isEmpty()</code>	return <code>true</code> if the vector contains no elements, <code>false</code> otherwise
<code>Object lastElement()</code>	return the last element in the vector; throw <code>NoSuchElementException</code> if the vector is empty
<code>int lastIndexOf(Object ob)</code>	return the position of the last occurrence of object <code>ob</code> in the vector; return <code>-1</code> if <code>ob</code> is not found
<code>int lastIndexOf(Object ob, int pos)</code>	return the position of the last occurrence of object <code>ob</code> in the vector beginning the backward search at position <code>pos</code> ; return <code>-1</code> if <code>ob</code> is not found; throw <code>IndexOutOfRangeException</code> if <code>pos</code> is greater than or equal to the size of the vector
<code>boolean remove(Object ob)</code>	remove the first occurrence of <code>ob</code> in the vector and return <code>true</code> if <code>ob</code> was in the vector

*Continues*

**FIGURE 1.3** (continued)

<code>Object remove(int pos)</code>	remove the object at position <code>pos</code> ; throw <code>ArrayIndexOutOfBoundsException</code> if <code>pos</code> is out of range
<code>boolean removeAll(Collection c)</code>	remove from the vector all the objects contained in collection <code>c</code> ; return <code>true</code> if any element was removed; throw <code>NullPointerException</code> if <code>c</code> is null
<code>boolean removeElement(Object ob)</code>	remove from the vector the first occurrence of <code>ob</code> ; return <code>true</code> if an occurrence of <code>ob</code> was found; same as <code>remove (ob)</code>
<code>void removeElementAt(int pos)</code>	remove the object at position <code>pos</code> ; throw <code>ArrayIndexOutOfBoundsException</code> if <code>pos</code> is out of range
<code>void removeAllElements()</code>	remove all the objects from the vector; same as <code>clear ()</code>
<code>void removeRange(int first, int last)</code>	remove objects starting at position <code>first</code> and ending at <code>last-1</code> and then shift all the succeeding objects to fill the hole (protected method)
<code>boolean retainAll(Collection c)</code>	remove from the vector all objects that are not in the collection <code>c</code> ; return <code>true</code> if any object was removed; throw <code>ArrayIndexOutOfBoundsException</code> if <code>pos</code> is out of range
<code>Object set(int pos, Object ob)</code>	assign object <code>ob</code> to position <code>pos</code> and return the object that occupied this position before the assignment; throw <code>ArrayIndexOutOfBoundsException</code> if <code>pos</code> is out of range
<code>void setElementAt(Object ob, int pos)</code>	assign object <code>ob</code> to position <code>pos</code> ; throw <code>ArrayIndexOutOfBoundsException</code> if <code>pos</code> is out of range
<code>void setSize(int sz)</code>	set size of the vector to <code>sz</code> ; if current size is greater than <code>sz</code> , add new cells with null objects; if the current size is smaller than <code>sz</code> , discard the overflowing objects; throw <code>ArrayIndexOutOfBoundsException</code> if <code>sz &lt; 0</code>
<code>int size()</code>	return the number of object in the vector
<code>List subList(int first, int last)</code>	return the sublist of the list (not its copy) containing elements from <code>first</code> to <code>last-1</code> ; throw <code>ArrayIndexOutOfBoundsException</code> if either <code>first</code> or <code>last</code> is out of range and <code>IllegalArgumentException</code> if <code>last &lt; first</code>
<code>Object[] toArray()</code>	copy all objects from the vector to a newly created array and return the array



**FIGURE 1.3** (continued)

<code>Object[] toArray(Object a[])</code>	copy all objects from the vector to the array <code>a</code> if <code>a</code> is large enough or to a newly created array and return the array; throw <code>ArrayStoreException</code> if type of <code>a</code> is not a supertype of the type of every element in the vector and <code>NullPointerException</code> if <code>a</code> is null
<code>String toString()</code>	return a string representation of the vector that contains the string representation of all the objects
<code>void trimToSize()</code>	change the capacity of the vector to the number of objects currently stored in it
<code>Vector()</code>	construct an empty vector
<code>Vector(Collection c)</code>	construct a vector with objects copied from collection <code>c</code> ; throw <code>NullPointerException</code> if <code>c</code> is null
<code>Vector(int initCap)</code>	construct a vector with the specified initial capacity; throw <code>IllegalArgumentException</code> if <code>initCap &lt; 0</code>
<code>Vector(int initCap, int capIncr)</code>	construct a vector with the specified initial capacity and capacity increment

An application of these methods is illustrated in Figure 1.4. The contents of affected vectors are shown as comments on the line in which the methods are called. The contents of vectors are output with an implicit call to the method `toString()` in

```
System.out.println("v1 = " + v1);
```

but in the program in Figure 1.4, only one such line is shown.

To use the class `Vector`, the program has to include the `import` instruction

```
import java.util.Vector;
```

`Vector v1` is declared empty, and then new elements are inserted with the method `addElement()`. Adding a new element to a vector is usually fast unless the vector is full and has to be copied to a new block. But if the vector has some unused cells, it can accommodate a new element immediately in constant time.

The status of the vector can be tested with two methods: `size()`, which returns the number of elements currently in the vector, and `capacity()`, which returns the number of cells in the vector. If the vector's capacity is greater than its size, then a new element can be inserted at the end of the vector immediately. How frequently a vector is filled and has to be copied depends on the interplay between these two parameters, size and capacity, and the third parameter, capacity increment. By default, a new empty vector has capacity 10, and its capacity is doubled every time its size reaches the current capacity. For a large vector, this may lead to wasted space. For example, a full vector containing 50,000 elements has 100,000 cells after a new element arrives, but

**FIGURE 1.4** A program demonstrating the operation of vector member functions.

```

import java.io.*;
import java.util.Vector;

class testVectors {
    public static void main(String a[]) {
        Vector v1 = new Vector();           // v1 = [], size = 0, capacity = 10
        for (int j = 1; j <= 5; j++)
            v1.addElement(new Integer(j)); // v1 = [1, 2, 3, 4, 5], size = 5,
                                           // capacity = 10

        System.out.println("v1 = " + v1);
        Integer i = new Integer(3);
        System.out.println(v1.indexOf(i) + " " + v1.indexOf(i,4)); // 2 -1
        System.out.println(v1.contains(i) + " " + v1.lastIndexOf(i)); // true 2
        Vector v2 = new Vector(3,4);       // v2 = [], size = 0, capacity = 3
        for (int j = 4; j <= 8; j++)
            v2.addElement(new Integer(j)); // v2 = [4, 5, 6, 7, 8], size = 5,
                                           // capacity = 7
        v2.ensureCapacity(9);               // v2 = [4, 5, 6, 7, 8], size = 5,
                                           // capacity = 11
        Vector v3 = new Vector(2);          // v3 = [], size = 0, capacity = 2
        v3.setSize(4);                      // v3 = [null, null, null, null],
                                           // size = cap = 4
        v3.setElementAt(new Integer(9),1); // v3 = [null, null, null, 9]
        v3.setElementAt(new Integer(5),3); // v3 = [null, 9, null, 5]
        v3.insertElementAt(v3.elementAt(3),1); // v3 = [null, 5, 9, null, 5],
                                           // size = 5, cap = 8
        v3.ensureCapacity(9);               // v3 = [null, 5, 9, null, 5],
                                           // size = 5, cap = 16
        v3.removeElement(new Integer(9));   // v3 = [null, 5, null, 5]
        v3.removeElementAt(v3.size()-2);    // v3 = [null, 5, 5]
        java.util.Enumeration ev = v3.elements();
        while (ev.hasMoreElements())
            System.out.print(ev.nextElement() + " ");
        System.out.println();
        v3.removeElementAt(0);               // v3 = [5, 5]
        v3.addAll(v1);                        // v3 = [5, 5, 1, 2, 3, 4, 5]
        v3.removeAll(v2);                    // v3 = [1, 2, 3] = v3 - v2
        v3.addAll(2,v1);                      // v3 = [1, 2, 1, 2, 3, 4, 5, 3]
        v3.retainAll(v2);                    // v3 = [4, 5] = intersection(v3,v2)
        v1.subList(1,3).clear();              // v1 = [1, 4, 5]
        Vector v4 = new Vector(), v5;
        v4.addElement(new Node("Jill",23));
        v5 = (Vector) v4.clone();             // v4 = [(Jill, 23)]
        ((Node)v5.firstElement()).age = 34; // v4 = v5 = [(Jill, 34)]
    }
}

```

the user may never include more elements than 50,001. In such a situation, the method `trimToSize()` should be used to reduce the waste.

When the user is reasonably sure of the maximum number of elements inserted in a vector, the method `ensureCapacity()` should be used to set capacity to the desired number so that all insertions are immediate. Otherwise, the user may set the capacity increment to a certain value so that when the vector is full, it is not doubled but increased by the capacity increment. Consider the declaration of vector `v2`:

```
Vector v2 = new Vector (3,4);
```

Initially, capacity is set to 3, and because the capacity increment equals 4, the capacity of the vector after inserting the fourth element equals 7. With this capacity, the statement

```
v2.ensureCapacity(9);
```

raises the capacity to 11 because it uses the capacity increment. Because the capacity increment for vector `v3` is not specified in its declaration, then when its capacity equals 8, the statement

```
v3.ensureCapacity(9);
```

causes the capacity to be doubled to 16.

The method `ensureCapacity()` affects only the capacity of the vector, not its content. The method `setSize()` affects its content and possibly the capacity. For example, the empty vector `v2` of capacity 2 changes to `v2 = [null, null, null, null]` after execution of

```
v2.setSize(4);
```

and its capacity equals 4.

The contents of `v2` are potentially dangerous if a method is executed that expects nonnull objects. For example, `v2.toString()` used in a printing statement raises `NullPointerException`. (To print a vector safely, a loop should be used in which `v.elementAt(i)` is printed.)

The method `addElement()` adds an element at the end of the vector. The insertion of an element in any other position can be performed with `insertElementAt()`. This reflects the fact that adding a new element inside the vector is a complex operation because it requires that all the elements are moved by one position to make room for the new element.

The method `elements()` puts vector elements in an object of `Enumeration` type. The loop shown in the program works the same for any data structure that returns an `Enumeration` object. In this way, data contained in different data structures become comparable by, as it were, equalizing the data structures themselves by using the common ground, the type `Enumeration`.

The method `clone()` should be used carefully. This method clones the array implementing the vector, but not the objects in the array. After the method is finished, the cloned vector includes references to the same objects as the vector from which it was cloned. In Figure 1.4, vector `v4` contains one object of type `Node` (as defined in Section 1.4), and then vector `v5`, a clone of `v4`, references the very same object from position 0. This is evident after the object is updated through reference `v5`; both `v4` and `v5` now reference the same updated object.

**1.6****DATA STRUCTURES AND OBJECT-ORIENTED PROGRAMMING**

Although the computer operates on bits, we do not usually think in these terms; in fact, we would not like to. Although an integer is a sequence of 32 bits, we prefer seeing an integer as an entity with its own individuality, which is reflected in operations that can be performed on integers but not on variables of other types. As an integer uses bits as its building blocks, so other objects can use integers as their atomic elements. Some data types are already built into a particular language, but some data types can be, and need to be, defined by the user. New data types have a distinctive structure, a new configuration of their elements, and this structure determines the behavior of objects of these new types. The task given to the data structures domain is to explore such new structures and investigate their behavior in terms of time and space requirements. Unlike the object-oriented approach, where we start with behavior and then try to find the most suitable data type that allows for an efficient performance of desirable operations, we now start with a data type specification with some data structure and then look at what it can do, how it does it, and how efficiently. The data structures field is designed for building tools to be incorporated in and used by programs and for finding data structures that can perform certain operations speedily and without imposing too much burden on computer memory. This field is interested in building classes by concentrating on the mechanics of these classes, on their gears and cogs, which in most cases are not visible to the user of the classes. The data structures field investigates the operability of these classes and its improvement by modifying the data structures to be found inside the classes, because it has direct access to them. It sharpens tools and advises the user to what purposes they can be applied. Because of inheritance, the user can add some more operations to these classes and try to squeeze from them more than the class designer did.

The data structures field performs best if done in the object-oriented fashion. In this way, it can build the tools it intends without the danger that these tools will be inadvertently misused in the application. By encapsulating the data structures into a class and making public only what is necessary for proper usage of the class, the data structures field can develop tools whose functioning is not compromised by unnecessary tampering.

**1.7****CASE STUDY: RANDOM ACCESS FILE**

From the perspective of the operating systems, files are collections of bytes, regardless of their contents. From the user's perspective, files are collections of words, numbers, data sequences, records, and so on. If the user wants to access the fifth word in a text file, a searching procedure goes sequentially through the file starting at position 0, and checks all of the bytes along the way. It counts the number of sequences of blank characters, and after it skips four such sequences (or five if a sequence of blanks begins the file), it stops because it encounters the beginning of the fifth nonblank sequence or the fifth word. This word can begin at any position of the file. It is impossible to go to a particular position of any text file and be certain that this is a starting position of the fifth word of the file. Ideally, we want to go directly to a certain position of the file and

be sure that the fifth word begins in it. The problem is caused by the lengths of the preceding words and sequences of blanks. If we know that each word occupies the same amount of space, then it is possible to go directly to the fifth word by going to the position  $4 \cdot \text{length}(\text{word})$ . But because words are of various lengths, this can be accomplished by assigning the same number of bytes to each word; if a word is shorter, some padding characters are added to fill up the remaining space; if it is longer, then the word is trimmed. In this way, a new organization is imposed on the file. The file is now treated not merely as a collection of bytes, but as a collection of records; in our example, each record consists of one word. If a request comes to access the fifth word, the word can be directly accessed without looking at the preceding words. With the new organization, we created a random access file.

A random access file allows for direct access of each record. The records usually include more items than one word. The preceding example suggests one way of creating a random access file, namely, by using fixed-length records. Our task in this case study is to write a generic program that generates a random access file for any type of record. The workings of the program are illustrated for a file containing personal records, each record consisting of five fields (social security number, name, city, year of birth, and salary), and for a student file that stores student records. The latter records have the same fields as personal records, plus information about academic major. This allows us to illustrate inheritance.

In this case study, a generic random access file program inserts a new record into a file, finds a record in the file, and modifies a record. The name of the file has to be supplied by the user, and if the file is not found, it is created; otherwise, it is open for reading and writing. The program is shown in Figure 1.5.

The program uses a class `IOmethods` and the interface `DBObject`. A user-defined class that specifies one record in the database is the extension `IOmethods` of an implementation of `DBObject`.

The class `Database` is generic so that it can operate on any random access file. Its generic character relies on polymorphism. Consider the method `find()`, which determines whether a record is in the file. It performs the search sequentially, comparing each retrieved record `tmp` to the sought record `d` using the method `equals()` defined for the particular class (or rather, redefined because the method is inherited from the class `Object` from which any other class is derived). The object `d` is passed in as a parameter to `find()`. But `d` must not be changed because its value is needed for comparison. Therefore, another object is needed to read data from the file. This object is created with the method `copy()`, which takes a one-cell array as a parameter and assigns the reference to a copy of `d` created by `new` in `copy()` to the only cell of the array. If parameter `copy()` were of type `DBObject`, not `DBObject[]`, the reference would be discarded because the parameter would be passed by value. Now, the array is also passed by value, but its cell is changed permanently. The cell `tmp[0]` now contains a copy of `d`—in particular, its type—so that the system uses methods of the particular class; for example, `tmp[0].readFromFile()` is taken from class `Personal` if `d` is an object of this type, and from `Student` if `d` is a `Student` object.

The method `find()` uses to some extent the fact that the file is random by scrutinizing it record by record, not byte by byte. To be sure, the records are built out of bytes and all the bytes belonging to a particular record have to be read, but only the bytes required by the equality operator are participating in the comparison.

**FIGURE 1.5** Listing of a program to manage random access files.

```
//***** DbObject.java *****  
  
import java.io.*;  
  
public interface DbObject {  
    public void writeToFile(RandomAccessFile out) throws IOException;  
    public void readFromFile(RandomAccessFile in) throws IOException;  
    public void readFromConsole() throws IOException;  
    public void writeLegibly() throws IOException;  
    public void readKey() throws IOException;  
    public void copy(DbObject[] db);  
    public int size();  
}  
  
//***** Personal.java *****  
  
import java.io.*;  
  
public class Personal extends IOMethods implements DbObject {  
    protected final int nameLen = 10, cityLen = 10;  
    protected String SSN, name, city;  
    protected int year;  
    protected long salary;  
    protected final int size = 9*2 + nameLen*2 + cityLen*2 + 4 + 8;  
    Personal() {  
    }  
    Personal(String ssn, String n, String c, int y, long s) {  
        SSN = ssn; name = n; city = c; year = y; salary = s;  
    }  
    public int size() {  
        return size;  
    }  
    public boolean equals(Object pr) {  
        return SSN.equals(((Personal)pr).SSN);  
    }  
    public void writeToFile(RandomAccessFile out) throws IOException {  
        writeString(SSN,out);  
        writeString(name,out);  
        writeString(city,out);  
        out.writeInt(year);  
        out.writeLong(salary);  
    }  
    public void writeLegibly() {
```

**FIGURE 1.5** (continued)

```

        System.out.print("SSN = " + SSN + ", name = " + name.trim()
            + ", city = " + city.trim() + ", year = " + year
            + ", salary = " + salary);
    }
    public void readFromFile(RandomAccessFile in) throws IOException {
        SSN = readString(9,in);
        name = readString(nameLen,in);
        city = readString(cityLen,in);
        year = in.readInt();
        salary = in.readLong();
    }
    public void readKey() throws IOException {
        System.out.print("Enter SSN: ");
        SSN = readLine();
    }
    public void readFromConsole() throws IOException {
        System.out.print("Enter SSN: ");
        SSN = readLine();
        System.out.print("Name: ");
        name = readLine();
        for (int i = name.length(); i < nameLen; i++)
            name += ' ';
        System.out.print("City: ");
        city = readLine();
        for (int i = city.length(); i < cityLen; i++)
            city += ' ';
        System.out.print("Birthyear: ");
        year = Integer.valueOf(readLine().trim()).intValue();
        System.out.print("Salary: ");
        salary = Long.valueOf(readLine().trim()).longValue();
    }
    public void copy(DbObject[] d) {
        d[0] = new Personal(SSN,name,city,year,salary);
    }
}

//***** Student.java *****

import java.io.*;

public class Student extends Personal {
    public int size() {

```

*Continues*

**FIGURE 1.5** (continued)

```

        return super.size() + majorLen*2;
    }
    protected String major;
    protected final int majorLen = 10;
    Student() {
        super();
    }
    Student(String ssn, String n, String c, int y, long s, String m) {
        super(ssn,n,c,y,s);
        major = m;
    }
    public void writeToFile(RandomAccessFile out) throws IOException {
        super.writeToFile(out);
        writeString(major,out);
    }
    public void readFromFile(RandomAccessFile in) throws IOException {
        super.readFromFile(in);
        major = readString(majorLen,in);
    }
    public void readFromConsole() throws IOException {
        super.readFromConsole();
        System.out.print("Enter major: ");
        major = readLine();
        for (int i = major.length(); i < nameLen; i++)
            major += ' ';
    }
    public void writeLegibly() {
        super.writeLegibly();
        System.out.print(", major = " + major.trim());
    }
    public void copy(DbObject[] d) {
        d[0] = new Student(SSN,name,city,year,salary,major);
    }
}

//***** Database.java *****

import java.io.*;

public class Database {
    private RandomAccessFile database;
    private String fName = new String();

```



**FIGURE 1.5** (continued)

```

private IOmethods io = new IOmethods();
Database() throws IOException {
    System.out.print("File name: ");
    fName = io.readLine();
}
private void add(DbObject d) throws IOException {
    database = new RandomAccessFile(fName,"rw");
    database.seek(database.length());
    d.writeToFile(database);
    database.close();
}
private void modify(DbObject d) throws IOException {
    DbObject[] tmp = new DbObject[1];
    d.copy(tmp);
    database = new RandomAccessFile(fName,"rw");
    while (database.getFilePointer() < database.length()) {
        tmp[0].readFromFile(database);
        if (tmp[0].equals(d)) {
            tmp[0].readFromConsole();
            database.seek(database.getFilePointer()-d.size());
            tmp[0].writeToFile(database);
            database.close();
            return;
        }
    }
    database.close();
    System.out.println("The record to be modified is not in the
database");
}
private boolean find(DbObject d) throws IOException {
    DbObject[] tmp = new DbObject[1];
    d.copy(tmp);
    database = new RandomAccessFile(fName,"r");
    while (database.getFilePointer() < database.length()) {
        tmp[0].readFromFile(database);
        if (tmp[0].equals(d)) {
            database.close();
            return true;
        }
    }
    database.close();
}

```

*Continues*

**FIGURE 1.5** (continued)

```
        return false;
    }
    private void printDb(DbObject d) throws IOException {
        database = new RandomAccessFile(fName, "r");
        while (database.getFilePointer() < database.length()) {
            d.readFromFile(database);
            d.writeLegibly();
            System.out.println();
        }
        database.close();
    }
    public void run(DbObject rec) throws IOException {
        String option;
        System.out.println("1. Add 2. Find 3. Modify a record; 4. Exit");
        System.out.print("Enter an option: ");
        option = io.readLine();
        while (true) {
            if (option.charAt(0) == '1') {
                rec.readFromConsole();
                add(rec);
            }
            else if (option.charAt(0) == '2') {
                rec.readKey();
                System.out.print("The record is ");
                if (find(rec) == false)
                    System.out.print("not ");
                System.out.println("in the database");
            }
            else if (option.charAt(0) == '3') {
                rec.readKey();
                modify(rec);
            }
            else if (option.charAt(0) != '4')
                System.out.println("Wrong option");
            else return;
            printDb(rec);
            System.out.print("Enter an option: ");
            option = io.readLine();
        }
    }
}
```

**FIGURE 1.5** (continued)

```

//***** UseDatabase.java *****
import java.io.*;

public class UseDatabase {
    static public void main(String[] args) throws IOException {
//        (new Database()).run(new Personal());
//        (new Database()).run(new Student());
    }
}

```

The method `modify()` updates information stored in a particular record. The record is first retrieved from the file, also using sequential search, and the new information is read from the user using the method `readFromFile()` defined for a particular class. To store the updated record `tmp[0]` in the file, `modify()` forces the file pointer `database` to go back to the beginning of the record `tmp[0]` that has just been read; otherwise, the record following `tmp[0]` in the file would be overwritten. The starting position of `tmp` can be determined immediately because each record occupies the same number of bytes; therefore, it is enough to jump back the number of bytes occupied by one record. This is accomplished by calling `database.seek(database.getFilePointer()-d.size())`, where `size()` must be defined for the particular class.

The generic `Database` class includes two more methods. Method `add()` places a record at the end of file. Method `printDb()` prints the contents of the file.

To see the class `Database` in action, we have to define a specific class that specifies the format of one record in a random access file. As an example, we define the class `Personal` with five fields, `SSN`, `name`, `city`, `year`, and `salary`. The first three fields are strings, but only `SSN` is always of the same size. To have slightly more flexibility with the other two strings, two constants, `nameLen` and `cityLen`, are defined.

Storing data from one object requires particular care, which is the task of the method `writeToFile()`. The `SSN` field is the simplest to handle. A social security number always includes nine digits; therefore, the output operator `<<` can be used. However, the lengths of names and cities vary from record to record, and yet the sections of a record in the data file designated for these two fields should always have the same length. To guarantee this, the method `readFromConsole()` adds trailing blanks to the strings.

Another problem is posed by the numerical fields, `year` and `salary`, particularly the latter field. If `salary` is written to the file with the method `printLong()`, then the salary 50,000 is written as a 5-byte-long string '50000', and the salary

100,000 as a 6-byte-long string '100000', which violates the condition that each record in the random access file should be of the same length. To avoid the problem, the numbers are stored in binary form. For example, 50,000 is represented in the field `salary` as a string of 32 bits, 00000000000000001100001101010000. We can now treat this sequence of bits as representing not a long number, but a string of four characters, 00000000, 00000000, 11000011, 01010000; that is, the characters whose ASCII codes are, in decimal, numbers 0, 0, 195, and 80. In this way, regardless of the value of `salary`, the value is always stored in 4 bytes. This is accomplished in Java with the method `writeLong()`.

This method of storing records in a data file poses a readability problem, particularly in the case of numbers. For example, 50,000 is stored as 4 bytes: two null characters, a special character, and a capital P. For a human reader, it is far from obvious that these characters represent 50,000. Therefore, a special routine is needed to output records in readable form. This is accomplished by using the method `writeLegibly()`, which explains why this program uses two methods for reading records and two for writing records: one is for maintaining data in a random access file, and the other is for reading and writing data in readable form.

To test the flexibility of the `Database` class, another user class is defined, class `Student`. This class is also used to show one more example of inheritance.

Class `Student` uses the same data fields as class `Personal` by being defined as a class derived from `Personal` plus one more field, a string field `major`. Processing input and output on objects of class type `Student` is very similar to that for class `Personal`, but the additional field has to be accounted for. This is done by redefining methods from the base class and at the same time reusing them. Consider the method `writeToFile()` for writing student records in a data file in fixed-length format:

```
public void writeToFile(RandomAccessFile out) throws IOException{
    super.writeToFile(out);
    writeString(major,out);
}
```

The method uses the base class's `writeToFile()` to initialize the five fields, `SSN`, `name`, `city`, `year`, and `salary`, and initializes the field `major`. Note that a special variable `super` must be used to indicate clearly that `writeToFile()` being defined for class `Student` calls `writeToFile()` already defined in base class `Personal`. However, class `Student` inherits without the modification method `readKey()` and the method `equals()`, because the same key is used in both `Personal` and `Student` objects to uniquely identify any record, namely, `SSN`.

## 1.8 EXERCISES

1. What should be the type of constructors defined in classes?
2. Assume that `classA` includes a `private` variable `k`, a variable `m` with no modifier, a `private protected` variable `n`, a `protected` variable `p`, and a `public` variable `q`. Moreover, `classB` is derived from `classA`, `classC` is not derived from `classA`, and all three classes are in the same package. In addition, `classD` is derived from `classA`, `classE` is not derived from `classA`, and `classA` is in a different package than `classD` and `classE`. Which of the five variables defined in `classA` can be used by any of the four other classes?
3. What happens if the declaration of `C`:

```
class C {
    void process1(char ch) {
        System.out.println("Inside process1 in C " + ch);
    }
    void process2(char ch) {
        System.out.println("Inside process2 in C " + ch);
    }
    void process3(char ch) {
        System.out.println("Inside process3 in C " + ch);
        process2(ch);
    }
}
```

is followed by the following declaration of its extension:

```
class ExtC extends C {
    void process1(int n) {
        System.out.println("Inside process1 in ExtC " + n);
    }
    void process2(char ch) {
        System.out.println("Inside process2 in ExtC " + ch);
    }
    void process4(int n) {
        System.out.println("Inside process4 in Ext C " + n);
    }
}
```

Which methods are invoked if the declaration of three objects

```
ExtC object1 = new ExtC();
C object2 = new ExtC(), object3 = new ExtC();
```

is followed by these statements; indicate any problems that these statements may cause:

```
object1.process1(1000);
object1.process4(2000);
object2.process1(3000);
object2.process4(4000);
object3.process1('P');
object3.process2('Q');
object3.process3('R');
```

4. For the declaration of I1:

```
interface I1 {
    int I1f1();
    void I1f2(int i);
}
```

identify the errors.

- a. in the declaration of the interface I2:

```
interface I2 extends I1 {
    double I2f1();
    void I2f2(int i);
    int I1f1();
    double I2f1() { return 10; }
    private int AC1f4();
    private int n = 10;
}
```

- b. in the declaration of class CI1:

```
class CI1 implements I1 {
    int I1f1() { . . . . . }
    void I1f2(int i) { . . . . . }
    int CI1f3() { . . . . . }
}
```

- c. and in the declaration of object c6:

```
I1 c6 = new I1();
```

5. Identify the errors:

```
a. abstract class AC1 {
    int AC1f1() { . . . . . }
    void AC1f2(int i) { . . . . . }
    int AC1f3();
}
```

- b. `interface C6 extends CAC1 { . . . }`  
where `CAC1` is a class.
  - c. `class CAC1AC2 extends AC1, AC2 { . . . }`  
where `AC1` and `AC2` are two abstract classes.
  - d. `AC1 c7 = new AC1();`  
where `AC1` is an abstract class.
6. What happens if the class `SomeInfo` instead of the definition of `equals()` from Section 1.2.4 uses the following definition of this method:

```
public boolean equals(SomeInfo si) {
    return n == si.n;
}
```

## 1.9 PROGRAMMING ASSIGNMENTS

1. Write a `Fraction` class that defines adding, subtracting, multiplying, and dividing fractions. Then write a method for reducing factors and methods for inputting and outputting fractions.
2. Write a class `Quaternion` that defines the four basic operations of quaternions and the two I/O operations. Quaternions, as defined in 1843 by William Hamilton and published in his *Lectures on Quaternions* in 1853, are an extension of complex numbers. Quaternions are quadruples of real numbers,  $(a, b, c, d) = a + bi + cj + dk$ , where  $1 = (1, 0, 0, 0)$ ,  $i = (0, 1, 0, 0)$ ,  $j = (0, 0, 1, 0)$ , and  $k = (0, 0, 0, 1)$  and the following equations hold:

$$\begin{aligned}
 i^2 = j^2 = k^2 &= -1 \\
 ij = k, jk = i, ki = j, ji = -k, kj = -i, ik = -j \\
 (a + bi + cj + dk) + (p + qi + rj + sk) \\
 &= (a + p) + (b + q)i + (c + r)j + (d + s)k \\
 (a + bi + cj + dk) \cdot (p + qi + rj + sk) \\
 &= (ap - bq - cr - ds) + (aq + bp + cs - dr)i \\
 &\quad + (ar + cp + dq - bs)j + (as + dp + br - cq)k.
 \end{aligned}$$

Use these equations in implementing a quaternion class.

3. Write a program to reconstruct a text from a concordance of words. This was a real problem of reconstructing some unpublished texts of the Dead Sea Scrolls using concordances. For example, here is William Wordsworth's poem, *Nature and the Poet*, and a concordance of words corresponding with the poem.

So pure the sky, so quiet was the air!  
 So like, so very like, was day to day!  
 Whene'er I look'd, thy image still was there;  
 It trembled, but it never pass'd away.

The 33-word concordance is as follows:

```
1:1 so quiet was the *air!
1:4 but it never pass'd *away.
1:4 It trembled, *but it never
1:2 was *day to day!
1:2 was day to *day!
1:3 thy *image still was there;
.....
1:2 so very like, *was day
1:3 thy image still *was there;
1:3 *Whene'er I look'd,
```

In this concordance, each word is shown in context of up to five words, and the word referred to on each line is preceded with an asterisk. For larger concordances, two numbers have to be included, a number corresponding with a poem and a number of the line where the words can be found. For example, assuming that 1 is the number of *Nature and the Poet*, line “1:4 but it never pass'd \*away.” means that the word “away” is found in this poem in line 4. Note that punctuation marks are included in the context.

Write a program that loads a concordance from a file and creates a vector where each cell is associated with one line of the concordance. Then, using a binary search, reconstruct the text.

4. Modify the program from the case study by maintaining an order during insertion of new records into the data file. This requires defining the method `compareTo()` in `Personal` and in `Student` to be used in a modified method `add()` in `Database`. The method finds a proper position for a record `d`, moves all the records in the file to make room for `d`, and writes `d` into the file. With the new organization of the data file, `find()` and `modify()` can also be modified. For example, `find()` stops sequential search when it encounters a record greater than the record looked for (or reaches the end of file). A more efficient strategy can use binary search, discussed in Section 2.7.
5. Write a program that maintains an order in the data file indirectly. Use a vector of file position pointers (obtained through `getFilePointer()`) and keep the vector in sorted order without changing the order of records in the file.
6. Modify the program from the case study to remove records from the data file. Define method `isNull()` in classes `Personal` and `Student` to determine that a record is null. Define also method `writeNullToFile()` in the two classes to overwrite a record to be deleted by a null record. A null record can be defined as having a non-numeric character (a tombstone) in the first position of the `SSN` field. Then define method `remove()` in `Database` (very similar to `modify()`), which locates the position of a record to be deleted and overwrites it with the null record. After a session is finished, a `Database` method `purge()` destructor should be invoked which copies nonnull records to a new data file, deletes the old data file, and renames the new data file with the name of the old data file.



 **BIBLIOGRAPHY*****Object-Oriented Programming***

Cardelli, Luca, and Wegner, Peter, "On Understanding Types, Data Abstraction, and Polymorphism," *Computing Surveys* 17 (1985), 471–522.

Ege, Raimund K., *Programming in an Object-Oriented Environment*, San Diego: Academic Press, 1992.

Khoshafian, Setrag, and Razmik, Abnous, *Object Orientation: Concepts, Languages, Databases, User Interfaces*, New York: Wiley, 1995.

Meyer, Bertrand, *Object-Oriented Software Construction*, Upper Saddle River, NJ: Prentice Hall, 1997.

***Java***

Dunn, Douglas, *Java Rules*, Reading, MA: Addison-Wesley, 2002.

Gittleman, Art, *Computing with Java*, El Granada, CA: Scott/Jones, 2002.

Gosling, James, Joy, Bill, and Bracha, Silad, *The Java Language Specification*, Boston: Addison-Wesley, 2000.

Naughton, Patrick, and Schildt, Herbert, *Java 2: The Complete Reference*, Berkeley, CA: Osborne McGraw-Hill, 1999.

Weber, Joe (ed.), *Using Java 2 Platform*, Indianapolis: Que, 1999.

Weiss, Mark A., *Data Structures and Problem Solving Using Java*, Reading, MA: Addison-Wesley, 2001.

# 2

# Complexity Analysis

## 2.1 COMPUTATIONAL AND ASYMPTOTIC COMPLEXITY

The same problem can frequently be solved with algorithms that differ in efficiency. The differences between the algorithms may be immaterial for processing a small number of data items, but these differences grow with the amount of data. To compare the efficiency of algorithms, a measure of the degree of difficulty of an algorithm called *computational complexity* was developed by Juris Hartmanis and Richard E. Stearns.

Computational complexity indicates how much effort is needed to apply an algorithm or how costly it is. This cost can be measured in a variety of ways, and the particular context determines its meaning. This book concerns itself with the two efficiency criteria: time and space. The factor of time is usually more important than that of space, so efficiency considerations usually focus on the amount of time elapsed when processing data. However, the most inefficient algorithm run on a Cray computer can execute much faster than the most efficient algorithm run on a PC, so run time is always system-dependent. For example, to compare 100 algorithms, all of them would have to be run on the same machine. Furthermore, the results of run-time tests depend on the language in which a given algorithm is written, even if the tests are performed on the same machine. If programs are compiled, they execute much faster than when they are interpreted. A program written in C or Ada may be 20 times faster than the same program encoded in BASIC or LISP.

To evaluate an algorithm's efficiency, real-time units such as microseconds and nanoseconds should not be used. Rather, logical units that express a relationship between the size  $n$  of a file or an array and the amount of time  $t$  required to process the data should be used. If there is a linear relationship between the size  $n$  and time  $t$ —that is,  $t_1 = cn_1$ —then an increase of data by a factor of 5 results in the increase of the execution time by the same factor; if  $n_2 = 5n_1$ , then  $t_2 = 5t_1$ . Similarly, if  $t_1 = \log_2 n$ , then doubling  $n$  increases  $t$  by only one unit of time. Therefore, if  $t_2 = \log_2(2n)$ , then  $t_2 = t_1 + 1$ .

A function expressing the relationship between  $n$  and  $t$  is usually much more complex, and calculating such a function is important only in regard to large bodies of data; any terms that do not substantially change the function's magnitude should

be eliminated from the function. The resulting function gives only an approximate measure of efficiency of the original function. However, this approximation is sufficiently close to the original, especially for a function that processes large quantities of data. This measure of efficiency is called *asymptotic complexity*, and is used when disregarding certain terms of a function to express the efficiency of an algorithm or when calculating a function is difficult or impossible and only approximations can be found. To illustrate the first case, consider the following example:

$$f(n) = n^2 + 100n + \log_{10}n + 1,000 \quad (2.1)$$

For small values of  $n$ , the last term, 1,000, is the largest. When  $n$  equals 10, the second ( $100n$ ) and last (1,000) terms are on equal footing with the other terms, making the same contribution to the function value. When  $n$  reaches the value of 100, the first and the second terms make the same contribution to the result. But when  $n$  becomes larger than 100, the contribution of the second term becomes less significant. Hence, for large values of  $n$ , due to the quadratic growth of the first term ( $n^2$ ), the value of the function  $f$  depends mainly on the value of this first term, as Figure 2.1 demonstrates. Other terms can be disregarded for large  $n$ .

**FIGURE 2.1** The growth rate of all terms of function  $f(n) = n^2 + 100n + \log_{10}n + 1,000$ .

$n$	$f(n)$		$n^2$		$100n$		$\log_{10}n$		1,000	
	Value	%	Value	%	Value	%	Value	%	Value	%
1	1,101		1	0.1	100	9.1	0	0.0	1,000	90.83
10	2,101		100	4.76	1,000	47.6	1	0.05	1,000	47.60
100	21,002		10,000	47.6	10,000	47.6	2	0.001	1,000	4.76
1,000	1,101,003		1,000,000	90.8	100,000	9.1	3	0.0003	1,000	0.09
10,000	101,001,004		100,000,000	99.0	1,000,000	0.99	4	0.0	1,000	0.001
100,000	10,010,001,005		10,000,000,000	99.9	10,000,000	0.099	5	0.0	1,000	0.00

## 2.2 BIG-O NOTATION

The most commonly used notation for specifying asymptotic complexity—that is, for estimating the rate of function growth—is the big-O notation introduced in 1894 by Paul Bachmann. Given two positive-valued functions  $f$  and  $g$ , consider the following definition:

**Definition 1:**  $f(n)$  is  $O(g(n))$  if there exist positive numbers  $c$  and  $N$  such that  $f(n) \leq cg(n)$  for all  $n \geq N$ .

This definition reads:  $f$  is big-O of  $g$  if there is a positive number  $c$  such that  $f$  is not larger than  $cg$  for sufficiently large  $ns$ ; that is, for all  $ns$  larger than some number

$N$ . The relationship between  $f$  and  $g$  can be expressed by stating either that  $g(n)$  is an upper bound on the value of  $f(n)$  or that, in the long run,  $f$  grows at most as fast as  $g$ .

The problem with this definition is that, first, it states only that there must exist certain  $c$  and  $N$ , but it does not give any hint of how to calculate these constants. Second, it does not put any restrictions on these values and gives little guidance in situations when there are many candidates. In fact, there are usually infinitely many pairs of  $c$ s and  $N$ s that can be given for the same pair of functions  $f$  and  $g$ . For example, for

$$f(n) = 2n^2 + 3n + 1 = O(n^2) \tag{2.2}$$

where  $g(n) = n^2$ , candidate values for  $c$  and  $N$  are shown in Figure 2.2.

**FIGURE 2.2** Different values of  $c$  and  $N$  for function  $f(n) = 2n^2 + 3n + 1 = O(n^2)$  calculated according to the definition of big-O.

$c$	$\geq 6$	$\geq 3\frac{3}{4}$	$\geq 3\frac{1}{9}$	$\geq 2\frac{13}{16}$	$\geq 2\frac{16}{25}$	...	$\rightarrow$	2
$N$	1	2	3	4	5	...	$\rightarrow$	$\infty$

We obtain these values by solving the inequality:

$$2n^2 + 3n + 1 \leq cn^2$$

or equivalently

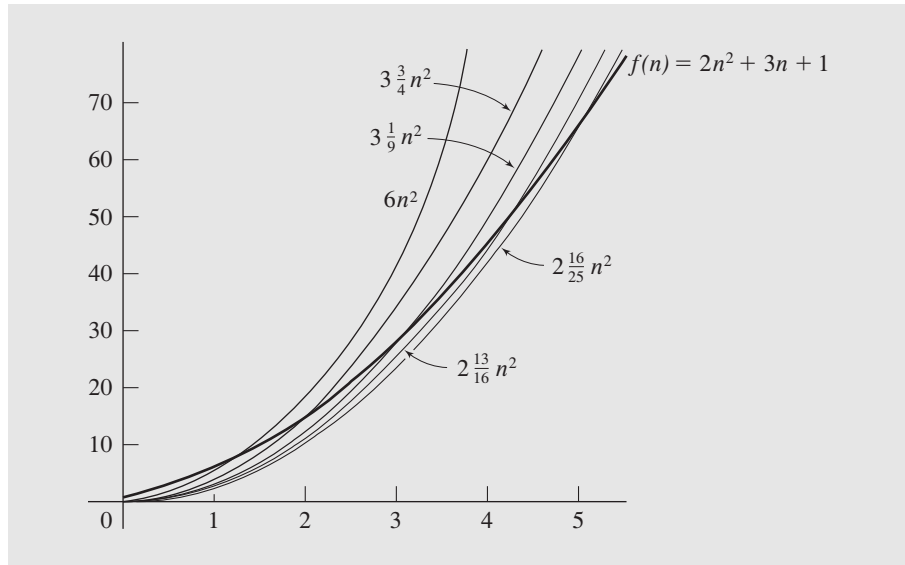
$$2 + \frac{3}{n} + \frac{1}{n^2} \leq c$$

for different  $n$ s. The first inequality results in substituting the quadratic function from Equation 2.2 for  $f(n)$  in the definition of the big-O notation and  $n^2$  for  $g(n)$ . Because it is one inequality with two unknowns, different pairs of constants  $c$  and  $N$  for the same function  $g(= n^2)$  can be determined. To choose the best  $c$  and  $N$ , it should be determined for which  $N$  a certain term in  $f$  becomes the largest and stays the largest. In Equation 2.2, the only candidates for the largest term are  $2n^2$  and  $3n$ ; these terms can be compared using the inequality  $2n^2 > 3n$  that holds for  $n > 1$ . Thus,  $N = 2$  and  $c \geq 3\frac{3}{4}$ , as Figure 2.2 indicates.

What is the practical significance of the pairs of constants just listed? All of them are related to the same function  $g(n) = n^2$  and to the same  $f(n)$ . For a fixed  $g$ , an infinite number of pairs of  $c$ s and  $N$ s can be identified. The point is that  $f$  and  $g$  grow at the same rate. The definition states, however, that  $g$  is almost always greater than or equal to  $f$  if it is multiplied by a constant  $c$ . “Almost always” means for all  $n$ s not less than a constant  $N$ . The crux of the matter is that the value of  $c$  depends on which  $N$  is chosen, and vice versa. For example, if 1 is chosen as the value of  $N$ —that is, if  $g$  is multiplied by  $c$  so that  $cg(n)$  will not be less than  $f$  right away—then  $c$  has to be equal to 6 or greater. If  $cg(n)$  is greater than or equal to  $f(n)$  starting from  $n = 2$ , then it is enough that  $c$  is equal to 3.75. The constant  $c$  has to be at least  $3\frac{3}{4}$  if  $cg(n)$  is not less than  $f(n)$  starting from

$n = 3$ . Figure 2.3 shows the graphs of the functions  $f$  and  $g$ . The function  $g$  is plotted with different coefficients  $c$ . Also,  $N$  is always a point where the functions  $cg(n)$  and  $f$  intersect each other.

**FIGURE 2.3** Comparison of functions for different values of  $c$  and  $N$  from Figure 2.2.



The inherent imprecision of the big-O notation goes even further, because there can be infinitely many functions  $g$  for a given function  $f$ . For example, the  $f$  from Equation 2.2 is big-O not only of  $n^2$ , but also of  $n^3$ ,  $n^4$ ,  $\dots$ ,  $n^k$ ,  $\dots$  for any  $k \geq 2$ . To avoid this embarrassment of riches, the smallest function  $g$  is chosen,  $n^2$  in this case.

The approximation of function  $f$  can be refined using big-O notation only for the part of the equation suppressing irrelevant information. For example, in Equation 2.1, the contribution of the third and last terms to the value of the function can be omitted (see Equation 2.3).

$$f(n) = n^2 + 100n + O(\log_{10}n) \quad (2.3)$$

Similarly, the function  $f$  in Equation 2.2 can be approximated as

$$f(n) = 2n^2 + O(n) \quad (2.4)$$

## 2.3 PROPERTIES OF BIG-O NOTATION

Big-O notation has some helpful properties that can be used when estimating the efficiency of algorithms.

**Fact 1.** (transitivity) If  $f(n)$  is  $O(g(n))$  and  $g(n)$  is  $O(h(n))$ , then  $f(n)$  is  $O(h(n))$ . (This can be rephrased as  $O(O(g(n)))$  is  $O(g(n))$ .)

**Proof:** According to the definition,  $f(n)$  is  $O(g(n))$  if there exist positive numbers  $c_1$  and  $N_1$  such that  $f(n) \leq c_1 g(n)$  for all  $n \geq N_1$ , and  $g(n)$  is  $O(h(n))$  if there exist positive numbers  $c_2$  and  $N_2$  such that  $g(n) \leq c_2 h(n)$  for all  $n \geq N_2$ . Hence,  $c_1 g(n) \leq c_1 c_2 h(n)$  for  $n \geq N$  where  $N$  is the larger of  $N_1$  and  $N_2$ . If we take  $c = c_1 c_2$ , then  $f(n) \leq ch(n)$  for  $n \geq N$ , which means that  $f$  is  $O(h(n))$ .

**Fact 2.** If  $f(n)$  is  $O(h(n))$  and  $g(n)$  is  $O(h(n))$ , then  $f(n) + g(n)$  is  $O(h(n))$ .

**Proof:** After setting  $c$  equal to  $c_1 + c_2$ ,  $f(n) + g(n) \leq ch(n)$ .

**Fact 3.** The function  $an^k$  is  $O(n^k)$ .

**Proof:** For the inequality  $an^k \leq cn^k$  to hold,  $c \geq a$  is necessary.

**Fact 4.** The function  $n^k$  is  $O(n^{k+j})$  for any positive  $j$ .

**Proof:** The statement holds if  $c = N = 1$ .

It follows from all these facts that every polynomial is big-O of  $n$  raised to the largest power, or

$$f(n) = a_k n^k + a_{k-1} n^{k-1} + \cdots + a_1 n + a_0 \text{ is } O(n^k)$$

It is also obvious that in the case of polynomials,  $f(n)$  is  $O(n^{k+j})$  for any positive  $j$ .

One of the most important functions in the evaluation of the efficiency of algorithms is the logarithmic function. In fact, if it can be stated that the complexity of an algorithm is on the order of the logarithmic function, the algorithm can be regarded as very good. There are an infinite number of functions that can be considered better than the logarithmic function, among which only a few, such as  $O(\lg \lg n)$  or  $O(1)$ , have practical bearing. Before we show an important fact about logarithmic functions, let us state without proof:

**Fact 5.** If  $f(n) = cg(n)$ , then  $f(n)$  is  $O(g(n))$ .

**Fact 6.** The function  $\log_a n$  is  $O(\log_b n)$  for any positive numbers  $a$  and  $b \neq 1$ .

This correspondence holds between logarithmic functions. Fact 6 states that regardless of their bases, logarithmic functions are big-O of each other; that is, all these functions have the same rate of growth.

**Proof:** Letting  $\log_a n = x$  and  $\log_b n = y$ , we have, by the definition of logarithm,  $a^x = n$  and  $b^y = n$ .

Taking  $\ln$  of both sides results in

$$x \ln a = \ln n \text{ and } y \ln b = \ln n$$

Thus

$$x \ln a = y \ln b,$$

$$\ln a \log_a n = \ln b \log_b n,$$

$$\log_a n = \frac{\ln b}{\ln a} \log_b n = c \log_b n$$

which proves that  $\log_a n$  and  $\log_b n$  are multiples of each other. By Fact 5,  $\log_a n$  is  $O(\log_b n)$ .

Because the base of the logarithm is irrelevant in the context of big-O notation, we can always use just one base and Fact 6 can be written as

**Fact 7.**  $\log_a n$  is  $O(\lg n)$  for any positive  $a \neq 1$ , where  $\lg n = \log_2 n$ .

## 2.4 $\Omega$ AND $\Theta$ NOTATIONS

Big-O notation refers to the upper bounds of functions. There is a symmetrical definition for a lower bound in the definition of big- $\Omega$ :

**Definition 2:** The function  $f(n)$  is  $\Omega(g(n))$  if there exist positive numbers  $c$  and  $N$  such that  $f(n) \geq cg(n)$  for all  $n \geq N$ .

This definition reads:  $f$  is  $\Omega$  (big-omega) of  $g$  if there is a positive number  $c$  such that  $f$  is at least equal to  $cg$  for almost all  $n$ s. In other words,  $cg(n)$  is a lower bound on the size of  $f(n)$ , or, in the long run,  $f$  grows at least at the rate of  $g$ .

The only difference between this definition and the definition of big-O notation is the direction of the inequality; one definition can be turned into the other by replacing “ $\geq$ ” with “ $\leq$ .” There is an interconnection between these two notations expressed by the equivalence

$$f(n) \text{ is } \Omega(g(n)) \text{ iff } g(n) \text{ is } O(f(n))$$

$\Omega$  notation suffers from the same profusion problem as does big-O notation: There is an unlimited number of choices for the constants  $c$  and  $N$ . For Equation 2.2, we are looking for such a  $c$ , for which  $2n^2 + 3n + 1 \geq cn^2$ , which is true for any  $n \geq 0$ , if  $c \leq 2$ , where 2 is the limit for  $c$  in Figure 2.2. Also, if  $f$  is an  $\Omega$  of  $g$  and  $h \leq g$ , then  $f$  is an  $\Omega$  of  $h$ ; that is, if for  $f$  we can find one  $g$  such that  $f$  is an  $\Omega$  of  $g$ , then we can find infinitely many. For example, the function 2.2 is an  $\Omega$  of  $n^2$  but also of  $n$ ,  $n^{1/2}$ ,  $n^{1/3}$ ,  $n^{1/4}$ , . . . , and also of  $\lg n$ ,  $\lg \lg n$ , . . . , and of many other functions. For practical purposes, only the closest  $\Omega$ s are the most interesting, (i.e., the largest lower bounds). This restriction is made implicitly each time we choose an  $\Omega$  of a function  $f$ .

There are an infinite number of possible lower bounds for the function  $f$ ; that is, there is an infinite set of  $g$ s such that  $f(n)$  is  $\Omega(g(n))$  as well as an unbounded number of possible upper bounds of  $f$ . This may be somewhat disquieting, so we restrict our attention to the smallest upper bounds and the largest lower bounds. Note that there is a common ground for big-O and  $\Omega$  notations indicated by the equalities in the definitions of these notations: Big-O is defined in terms of “ $\leq$ ” and  $\Omega$  in terms of “ $\geq$ ”; “ $=$ ” is included in both inequalities. This suggests a way of restricting the sets of possible lower and upper bounds. This restriction can be accomplished by the following definition of  $\Theta$  (theta) notation:

**Definition 3:**  $f(n)$  is  $\Theta(g(n))$  if there exist positive numbers  $c_1$ ,  $c_2$ , and  $N$  such that  $c_1g(n) \leq f(n) \leq c_2g(n)$  for all  $n \geq N$ .

This definition reads:  $f$  has an order of magnitude  $g$ ,  $f$  is on the order of  $g$ , or both functions grow at the same rate in the long run. We see that  $f(n)$  is  $\Theta(g(n))$  if  $f(n)$  is  $O(g(n))$  and  $f(n)$  is  $\Omega(g(n))$ .

The only function just listed that is both big-O and  $\Omega$  of the function 2.2 is  $n^2$ . However, it is not the only choice, and there are still an infinite number of choices, because the functions  $2n^2, 3n^2, 4n^2, \dots$  are also  $\Theta$  of function 2.2. But it is rather obvious that the simplest,  $n^2$ , will be chosen.

When applying any of these notations (big-O,  $\Omega$ , and  $\Theta$ ), do not forget that they are approximations that hide some detail that in many cases may be considered important.

## 2.5 POSSIBLE PROBLEMS

All the notations serve the purpose of comparing the efficiency of various algorithms designed for solving the same problem. However, if only big-Os are used to represent the efficiency of algorithms, then some of them may be rejected prematurely. The problem is that in the definition of big-O notation,  $f$  is considered  $O(g(n))$  if the inequality  $f(n) \leq cg(n)$  holds in the long run for all natural numbers with a few exceptions. The number of  $n$ s violating this inequality is always finite. It is enough to meet the condition of the definition. As Figure 2.2 indicates, this number of exceptions can be reduced by choosing a sufficiently large  $c$ . However, this may be of little practical significance if the constant  $c$  in  $f(n) \leq cg(n)$  is prohibitively large, say  $10^8$ , although the function  $g$  taken by itself seems to be promising.

Consider that there are two algorithms to solve a certain problem and suppose that the number of operations required by these algorithms is  $10^8n$  and  $10n^2$ . The first function is  $O(n)$  and the second is  $O(n^2)$ . Using just the big-O information, the second algorithm is rejected because the number of steps grows too fast. It is true but, again, in the long run, because for  $n \leq 10^7$ , which is 10 million, the second algorithm performs fewer operations than the first. Although 10 million is not an unheard-of number of elements to be processed by an algorithm, in many cases the number is much lower, and in these cases the second algorithm is preferable.

For these reasons, it may be desirable to use one more notation that includes constants which are very large for practical reasons. Udi Manber proposes a double-O ( $OO$ ) notation to indicate such functions:  $f$  is  $OO(g(n))$  if it is  $O(g(n))$  and the constant  $c$  is too large to have practical significance. Thus,  $10^8n$  is  $OO(n)$ . However, the definition of “too large” depends on the particular application.

## 2.6 EXAMPLES OF COMPLEXITIES

Algorithms can be classified by their time or space complexities, and in this respect, several classes of such algorithms can be distinguished, as Figure 2.4 illustrates. Their growth is also displayed in Figure 2.5. For example, an algorithm is called *constant* if its execution time remains the same for any number of elements; it is called *quadratic* if its execution time is  $O(n^2)$ . For each of these classes, a number of operations is



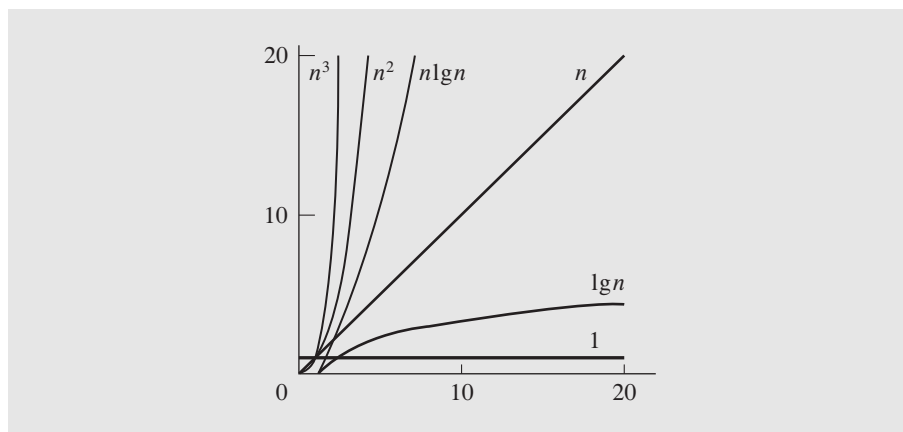
**FIGURE 2.4** Classes of algorithms and their execution times on a computer executing 1 million operations per second (1 sec =  $10^6$   $\mu$ sec =  $10^3$  msec).

Class	Complexity	Number of Operations and Execution Time (1 instr/ $\mu$ sec)					
		10		$10^2$		$10^3$	
$n$							
constant	$O(1)$	1	1 $\mu$ sec	1	1 $\mu$ sec	1	1 $\mu$ sec
logarithmic	$O(\lg n)$	3.32	3 $\mu$ sec	6.64	7 $\mu$ sec	9.97	10 $\mu$ sec
linear	$O(n)$	10	10 $\mu$ sec	$10^2$	100 $\mu$ sec	$10^3$	1 msec
$O(n \lg n)$	$O(n \lg n)$	33.2	33 $\mu$ sec	664	664 $\mu$ sec	9970	10 msec
quadratic	$O(n^2)$	$10^2$	100 $\mu$ sec	$10^4$	10 msec	$10^6$	1 sec
cubic	$O(n^3)$	$10^3$	1 msec	$10^6$	1 sec	$10^9$	16.7 min
exponential	$O(2^n)$	1024	10 msec	$10^{30}$	$3.17 \times 10^{17}$ yrs	$10^{301}$	

Class	Complexity	Number of Operations and Execution Time (1 instr/ $\mu$ sec)					
		$10^4$		$10^5$		$10^6$	
$n$							
constant	$O(1)$	1	1 $\mu$ sec	1	1 $\mu$ sec	1	1 $\mu$ sec
logarithmic	$O(\lg n)$	13.3	13 $\mu$ sec	16.6	7 $\mu$ sec	19.93	20 $\mu$ sec
linear	$O(n)$	$10^4$	10 msec	$10^5$	0.1 sec	$10^6$	1 sec
$O(n \lg n)$	$O(n \lg n)$	$133 \times 10^3$	133 msec	$166 \times 10^4$	1.6 sec	$199.3 \times 10^5$	20 sec
quadratic	$O(n^2)$	$10^8$	1.7 min	$10^{10}$	16.7 min	$10^{12}$	11.6 days
cubic	$O(n^3)$	$10^{12}$	11.6 days	$10^{15}$	31.7 yr	$10^{18}$	31,709 yr
exponential	$O(2^n)$	$10^{3010}$		$10^{30103}$		$10^{301030}$	

**FIGURE 2.5** Typical functions applied in big-O estimates.



shown along with the real time needed for executing them on a machine able to perform 1 million operations per second, or one operation per microsecond ( $\mu\text{sec}$ ). The table in Figure 2.4 indicates that some ill-designed algorithms, or algorithms whose complexity cannot be improved, have no practical application on available computers. To process 1 million items with a quadratic algorithm, over 11 days are needed, and for a cubic algorithm, thousands of years. Even if a computer can perform one operation per nanosecond (1 billion operations per second), the quadratic algorithm finishes in only 16.7 seconds, but the cubic algorithm requires over 31 years. Even a 1,000-fold improvement in execution speed has very little practical bearing for this algorithm. Analyzing the complexity of algorithms is of extreme importance and cannot be abandoned on account of the argument that we have entered an era when, at relatively little cost, a computer on our desktop can execute millions of operations per second. The importance of analyzing the complexity of algorithms, in any context but in the context of data structures in particular, cannot be overstressed. The impressive speed of computers is of limited use if the programs that run on them use inefficient algorithms.

## 2.7 FINDING ASYMPTOTIC COMPLEXITY: EXAMPLES

Asymptotic bounds are used to estimate the efficiency of algorithms by assessing the amount of time and memory needed to accomplish the task for which the algorithms were designed. This section illustrates how this complexity can be determined.

In most cases, we are interested in time complexity, which usually measures the number of assignments and comparisons performed during the execution of a program. Chapter 9, which deals with sorting algorithms, considers both types of operations; this chapter considers only the number of assignment statements.

Begin with a simple loop to calculate the sum of numbers in an array:

```
for (i = sum = 0; i < n; i++)
    sum += a[i];
```

First, two variables are initialized, then the `for` loop iterates  $n$  times, and during each iteration, it executes two assignments, one of which updates `sum` and the other of which updates `i`. Thus, there are  $2 + 2n$  assignments for the complete run of this `for` loop; its asymptotic complexity is  $O(n)$ .

Complexity usually grows if nested loops are used, as in the following code, which outputs the sums of all the subarrays that begin with position 0:

```
for (i = 0; i < n; i++) {
    for (j = 1, sum = a[0]; j <= i; j++)
        sum += a[j];
    System.out.println ("sum for subarray 0 through "+i+" is" + sum);
}
```

Before the loops start, `i` is initialized. The outer loop is performed  $n$  times, executing in each iteration an inner `for` loop, print statement, and assignment statements for `i`, `j`, and `sum`. The inner loop is executed  $i$  times for each  $i \in \{1, \dots, n-1\}$

with two assignments in each iteration: one for `sum` and one for `j`. Therefore, there are  $1 + 3n + \sum_{i=1}^{n-1} 2i = 1 + 3n + 2(1 + 2 + \dots + n - 1) = 1 + 3n + n(n - 1) = O(n) + O(n^2) = O(n^2)$  assignments executed before the program is completed.

Algorithms with nested loops usually have a larger complexity than algorithms with one loop, but it does not have to grow at all. For example, we may request printing sums of numbers in the last five cells of the subarrays starting in position 0. We adopt the foregoing code and transform it to

```
for (i = 4; i < n; i++) {
    for (j = i-3, sum = a[i-4]; j <= i; j++)
        sum += a[j];
    System.out.println ("sum for subarray "+(i - 4)+" through "+i+" is"+ sum);
}
```

The outer loop is executed  $n - 4$  times. For each  $i$ , the inner loop is executed only four times: For each iteration of the outer loop, there are eight assignments in the inner loop, and this number does not depend on the size of the array. With initialization of `i`,  $n - 4$  autoincrements of `i`, and  $n - 4$  initializations of `j` and `sum`, the program makes  $1 + 8 \cdot (n - 4) = O(n)$  assignments.

Analysis of these two examples is relatively uncomplicated because the number of times the loops executed did not depend on the ordering of the arrays. Computation of asymptotic complexity is more involved if the number of iterations is not always the same. This point can be illustrated with a loop used to determine the length of the longest subarray with the numbers in increasing order. For example, in [1 8 1 2 5 0 11 12], it is three, the length of subarray [1 2 5]. The code is

```
for (i = 0, length = 1; i < n-1; i++) {
    for (i1 = i2 = k = i; k < n-1 && a[k] < a[k+1]; k++, i2++);
    if (length < i2 - i1 + 1)
        length = i2 - i1 + 1;
    System.out.println ("the length of the longest ordered subarray is" + length);
}
```

Notice that if all numbers in the array are in decreasing order, the outer loop is executed  $n - 1$  times, but in each iteration, the inner loop executes just one time. Thus, the algorithm is  $O(n)$ . The algorithm is least efficient if the numbers are in increasing order. In this case, the outer `for` loop is executed  $n - 1$  times, and the inner loop is executed  $n - 1 - i$  times for each  $i \in \{0, \dots, n - 2\}$ . Thus, the algorithm is  $O(n^2)$ . In most cases, the arrangement of data is less orderly, and measuring the efficiency in these cases is of great importance. However, it is far from trivial to determine the efficiency in the average cases.

A last example used to determine the computational complexity is the *binary search algorithm*, which is used to locate an element in an ordered array. If it is an array of numbers and we try to locate number  $k$ , then the algorithm accesses the middle element of the array first. If that element is equal to  $k$ , then the algorithm returns its position; if not, the algorithm continues. In the second trial, only half of the original array is considered: the first half if  $k$  is smaller than the middle element, and the second otherwise. Now, the middle element of the chosen subarray is accessed and compared to  $k$ . If it is the same, the algorithm completes successfully. Otherwise, the

subarray is divided into two halves, and if  $k$  is larger than this middle element, the first half is discarded; otherwise, the first half is retained. This process of halving and comparing continues until  $k$  is found or the array can no longer be divided into two subarrays. This relatively simple algorithm can be coded as follows:

```
int binarySearch(int[] arr, int key) {
    int lo = 0, mid, hi = arr.length-1;
    while (lo <= hi) {
        mid = (lo + hi)/2;
        if (key < arr[mid])
            hi = mid - 1;
        else if (arr[mid] < key)
            lo = mid + 1;
        else return mid; // success: return the index of
    } // the cell occupied by key;
    return -1; // failure: key is not in the array;
}
```

If  $key$  is in the middle of the array, the loop executes only one time. How many times does the loop execute in the case where  $key$  is not in the array? First the algorithm looks at the entire array of size  $n$ , then at one of its halves of size  $\frac{n}{2}$ , then at one of the halves of this half, of size  $\frac{n}{2^2}$ , and so on, until the array is of size 1. Hence, we have the sequence  $n, \frac{n}{2}, \frac{n}{2^2}, \dots, \frac{n}{2^m}$ , and we want to know the value of  $m$ . But the last term of this sequence  $\frac{n}{2^m}$  equals 1, from which we have  $m = \lg n$ . So the fact that  $k$  is not in the array can be determined after  $\lg n$  iterations of the loop.

## 2.8 THE BEST, AVERAGE, AND WORST CASES

The last two examples in the preceding section indicate the need for distinguishing at least three cases for which the efficiency of algorithms has to be determined. The *worst case* is when an algorithm requires a maximum number of steps, and the *best case* is when the number of steps is the smallest. The *average case* falls between these extremes. In simple cases, the average complexity is established by considering possible inputs to an algorithm, determining the number of steps performed by the algorithm for each input, adding the number of steps for all the inputs, and dividing by the number of inputs. This definition, however, assumes that the probability of occurrence of each input is the same, which is not always the case. To consider the probability explicitly, the average complexity is defined as the average over the number of steps executed when processing each input weighted by the probability of occurrence of this input, or,

$$C_{\text{avg}} = \sum_i p(\text{input}_i) \text{steps}(\text{input}_i)$$

This is the definition of expected value, which assumes that all the possibilities can be determined and that the probability distribution is known, which simply determines a probability of occurrence of each input,  $p(\text{input}_i)$ . The probability function  $p$  satis-

fies two conditions: It is never negative,  $p(\text{input}_i) \geq 0$ , and all probabilities add up to 1,  $\sum_i p(\text{input}_i) = 1$ .

As an example, consider searching sequentially an unordered array to find a number. The best case is when the number is found in the first cell. The worst case is when the number is in the last cell or is not in the array at all. In this case, all the cells are checked to determine this fact. And the average case? We may make the assumption that there is an equal chance for the number to be found in any cell of the array; that is, the probability distribution is uniform. In this case, there is a probability equal to  $\frac{1}{n}$  that the number is in the first cell, a probability equal to  $\frac{1}{n}$  that it is in the second cell, . . . , and finally, a probability equal to  $\frac{1}{n}$  that it is in the last,  $n$ th cell. This means that the probability of finding the number after one try equals  $\frac{1}{n}$ , the probability of having two tries equals  $\frac{1}{n}$ , . . . , and the probability of having  $n$  tries also equals  $\frac{1}{n}$ . Therefore, we can average all these possible numbers of tries over the number of possibilities and conclude that it takes on the average

$$\frac{1 + 2 + \dots + n}{n} = \frac{n + 1}{2}$$

steps to find a number. But if the probabilities differ, then the average case gives a different outcome. For example, if the probability of finding a number in the first cell equals  $\frac{1}{2}$ , the probability of finding it in the second cell equals  $\frac{1}{4}$ , and the probability of locating it in any of the remaining cells is the same and equal to

$$\frac{1 - \frac{1}{2} - \frac{1}{4}}{n - 2} = \frac{1}{4(n - 2)}$$

then, on the average, it takes

$$\frac{1}{2} + \frac{2}{4} + \frac{3 + \dots + n}{4(n - 2)} = 1 + \frac{n(n + 1) - 6}{8(n - 2)} = 1 + \frac{n + 3}{8}$$

steps to find a number, which is approximately four times better than  $\frac{n+1}{2}$  found previously for the uniform distribution. Note that the probabilities of accessing a particular cell have no impact on the best and worst cases.

The complexity for the three cases was relatively easy to determine for sequential search, but usually it is not that straightforward. Particularly, the complexity of the average case can pose difficult computational problems. If the computation is very complex, approximations are used, and that is where we find the big-O,  $\Omega$ , and  $\Theta$  notations most useful.

As an example, consider the average case for binary search. Assume that the size of the array is a power of 2 and that a number to be searched has an equal chance to be in any of the cells of the array. Binary search can locate it either after one try in the middle of the array, or after two tries in the middle of the first half of the array, or after three tries in the middle of the second half, or after three tries in the middle of the first quarter of the array, or . . . or after three tries in the middle of the fourth quarter, or after four tries in the middle of the first eighth of the array, or . . . or after four tries in

the middle of the eighth eighth of the array, or . . . or after try  $\lg n$  in the first cell, or after try  $\lg n$  in the third cell, or . . . or, finally, after try  $\lg n$  in the last cell. That is, the number of all possible tries equals

$$1 \cdot 1 + 2 \cdot 2 + 4 \cdot 3 + 8 \cdot 4 + \dots + \frac{n}{2} \lg n = \sum_{i=0}^{\lg n - 1} 2^i (i + 1)$$

which has to be divided by  $\frac{1}{n}$  to determine the average case complexity. What is this sum equal to? We know that it is between 1 (the best case result) and  $\lg n$  (the worst case) determined in the preceding section. But is it closer to the best case—say,  $\lg \lg n$ —or to the worst case—for instance,  $\frac{\lg n}{2}$ , or  $\lg \frac{n}{2}$ ? The sum does not lend itself to a simple conversion into a closed form; therefore, its estimation should be used. Our conjecture is that the sum is not less than the sum of powers of 2 in the specified range multiplied by a half of  $\lg n$ , that is,

$$s_1 = \sum_{i=0}^{\lg n - 1} 2^i (i + 1) \geq \frac{\lg n}{2} \sum_{i=0}^{\lg n - 1} 2^i = s_2$$

The reason for this choice is that  $s_2$  is a power series multiplied by a constant factor, and thus, it can be presented in closed form very easily, namely,

$$s_2 = \frac{\lg n}{2} \sum_{i=0}^{\lg n - 1} 2^i = \frac{\lg n}{2} \left( 1 + 2 \frac{2^{\lg n - 1} - 1}{2 - 1} \right) = \frac{\lg n}{2} (n - 1)$$

which is  $\Omega(n \lg n)$ . Because  $s_2$  is the lower bound for the sum  $s_1$  under scrutiny—that is,  $s_1$  is  $\Omega(s_2)$ —then so is  $\frac{s_2}{n}$  the lower bound of the sought average case complexity  $\frac{s_1}{n}$ —that is,  $\frac{s_1}{n} = \Omega\left(\frac{s_2}{n}\right)$ . Because  $\frac{s_2}{n}$  is  $\Omega(\lg n)$ , so must be  $\frac{s_1}{n}$ . Because  $\lg n$  is an assessment of the complexity of the worst case, the average case's complexity equals  $\Theta(\lg n)$ .

There is still one unresolved problem: Is  $s_1 \geq s_2$ ? To determine this, we conjecture that the sum of each pair of terms positioned symmetrically with respect to the center of the sum  $s_1$  is not less than the sum of the corresponding terms of  $s_2$ . That is,

$$\begin{aligned} 2^0 \cdot 1 + 2^{\lg n - 1} \lg n &\geq 2^0 \frac{\lg n}{2} + 2^{\lg n - 1} \frac{\lg n}{2} \\ 2^1 \cdot 2 + 2^{\lg n - 2} (\lg n - 1) &\geq 2^1 \frac{\lg n}{2} + 2^{\lg n - 2} \frac{\lg n}{2} \\ &\dots \\ 2^j (j + 1) + 2^{\lg n - 1 - j} (\lg n - j) &\geq 2^j \frac{\lg n}{2} + 2^{\lg n - 1 - j} \frac{\lg n}{2} \\ &\dots \end{aligned}$$

where  $j \leq \frac{\lg n}{2} - 1$ . The last inequality, which represents every other inequality, is transformed into

$$2^{\lg n - 1 - j} \left( \frac{\lg n}{2} - j \right) \geq 2^j \left( \frac{\lg n}{2} - j - 1 \right)$$

and then into

$$2^{\lg n - 1 - 2j} \geq \frac{\frac{\lg n}{2} - j - 1}{\frac{\lg n}{2} - j} = 1 - \frac{1}{\frac{\lg n}{2} - j} \quad (2.5)$$

All of these transformations are allowed because all the terms that moved from one side of the conjectured inequality to another are nonnegative and thus do not change the direction of inequality. Is the inequality true? Because  $j \leq \frac{\lg n}{2} - 1$ ,  $2^{\lg n - 1 - 2j} \geq 2$ , and the right-hand side of the inequality (2.5) is always less than 1, the conjectured inequality is true.

This concludes our investigation of the average case for binary search. The algorithm is relatively straightforward, but the process of finding the complexity for the average case is rather grueling, even for uniform probability distributions. For more complex algorithms, such calculations are significantly more challenging.

## 2.9

## AMORTIZED COMPLEXITY

In many situations, data structures are subject to a sequence of operations rather than one operation. In this sequence, one operation possibly performs certain modifications that have an impact on the run time of the next operation in the sequence. One way of assessing the worst case run time of the entire sequence is to add worst case efficiencies for each operation. But this may result in an excessively large and unrealistic bound on the actual run time. To be more realistic, amortized analysis can be used to find the average complexity of a worst case sequence of operations. By analyzing sequences of operations rather than isolated operations, amortized analysis takes into account interdependence between operations and their results. For example, if an array is sorted and only a very few new elements are added, then re-sorting this array should be much faster than sorting it for the first time because, after the new additions, the array is nearly sorted. Thus, it should be quicker to put all elements in perfect order than in a completely disorganized array. Without taking this correlation into account, the run time of the two sorting operations can be considered twice the worst case efficiency. Amortized analysis, on the other hand, decides that the second sorting is hardly applied in the worst case situation so that the combined complexity of the two sorting operations is much less than double the worst case complexity. Consequently, the average for the worst case sequence of sorting, a few insertions, and sorting again is lower according to amortized analysis than according to worst case analysis, which disregards the fact that the second sorting is applied to an array operated on already by a previous sorting.

It is important to stress that amortized analysis is analyzing sequences of operations, or if single operations are analyzed, it is done in view of their being part of the sequence. The cost of operations in the sequence may vary considerably, but how

frequently particular operations occur in the sequence is important. For example, for the sequence of operations  $op_1, op_2, op_3, \dots$ , the worst case analysis renders the computational complexity for the entire sequence equal to

$$C(op_1, op_2, op_3, \dots) = C_{\text{worst}}(op_1) + C_{\text{worst}}(op_2) + C_{\text{worst}}(op_3) + \dots$$

whereas the average complexity determines it to be

$$C(op_1, op_2, op_3, \dots) = C_{\text{avg}}(op_1) + C_{\text{avg}}(op_2) + C_{\text{avg}}(op_3) + \dots$$

Although specifying complexities for a sequence of operations, neither worst case analysis nor average case analysis was looking at the position of a particular operation in the sequence. These two analyses considered the operations as executed in isolation and the sequence as a collection of isolated and independent operations. Amortized analysis changes the perspective by looking at what happened up until a particular point in the sequence of operations and then determines the complexity of a particular operation,

$$C(op_1, op_2, op_3, \dots) = C(op_1) + C(op_2) + C(op_3) + \dots$$

where  $C$  can be the worst, the average, the best case complexity, or very likely, a complexity other than the three depending on what happened before. To find amortized complexity in this way may be, however, too complicated. Therefore, another approach is used. The knowledge of the nature of particular processes and possible changes of a data structure is used to determine the function  $C$ , which can be applied to each operation of the sequence. The function is chosen in such a manner that it considers quick operations as slower than they really are and time-consuming operations as quicker than they actually are. It is as though the cheap (quick) operations are charged more time units to generate credit to be used for covering the cost of expensive operations that are charged below their real cost. It is like letting the government charge us more for income taxes than necessary so that at the end of the fiscal year the overpayment can be received back and used to cover the expenses of something else. The art of amortized analysis lies in finding an appropriate function  $C$  so that it overcharges cheap operations sufficiently to cover expenses of undercharged operations. The overall balance must be nonnegative. If a debt occurs, there must be a prospect of paying it.

Consider the operation of adding a new element to the vector implemented as a flexible array. The best case is when the size of the vector is less than its capacity because adding a new element amounts to putting it in the first available cell. The cost of adding a new element is thus  $O(1)$ . The worst case is when size equals capacity, in which case there is no room for new elements. In this case, new space must be allocated, the existing elements are copied to the new space, and only then can the new element be added to the vector. The cost of adding a new element is  $O(\text{size}(\text{vector}))$ . It is clear that the latter situation is less frequent than the former, but this depends on another parameter, capacity increment, which refers to how much the vector is increased when overflow occurs. In the extreme case, it can be incremented by just one cell, so in the sequence of  $m$  consecutive insertions, each insertion causes overflow and requires  $O(\text{size}(\text{vector}))$  time to finish. Clearly, this situation should be delayed. One solution is to allocate, say, 1 million cells for the vector, which in most cases does not cause an



overflow, but the amount of space is excessively large and only a small percentage of space allocated for the vector may be expected to be in actual use. Another solution to the problem is to double the space allocated for the vector if overflow occurs. In this case, the pessimistic  $O(\text{size}(\text{vector}))$  performance of the insertion operation may be expected to occur only infrequently. By using this estimate, it may be claimed that, in the best case, the cost of inserting  $m$  items is  $O(m)$ , but it is impossible to claim that, in the worst case, it is  $O(m \cdot \text{size}(\text{vector}))$ . Therefore, to see better what impact this performance has on the sequence of operations, the amortized analysis should be used.

In amortized analysis, the question is asked: What is the expected efficiency of a sequence of insertions? We know that the best case is  $O(1)$  and the worst case is  $O(\text{size}(\text{vector}))$ , but also we know that the latter case occurs only occasionally and leads to doubling the size of the vector. In this case, what is the expected efficiency of one insertion in the series of insertions? Note that we are interested only in sequences of insertions, excluding deletions and modifications, to have the worst case scenario. The outcome of amortized analysis depends on the assumed amortized cost of one insertion. It is clear that if

$$\text{amCost}(\text{push}(x)) = 1$$

where 1 represents the cost of one insertion, then we are not gaining anything from this analysis because easy insertions are paying for themselves right away, and the insertions causing overflow and thus copying have no credit to use to make up for their high cost. Is

$$\text{amCost}(\text{push}(x)) = 2$$

a reasonable choice? Consider the table in Figure 2.6a. It shows the change in vector capacity and the cost of insertion when size grows from 0 to 18; that is, the table indicates the changes in the vector during the sequence of 18 insertions into an initially empty vector. For example, if there are four elements in the vector ( $\text{size} = 4$ ), then before inserting the fifth element, the four elements are copied at the cost of four units and then the new fifth element is inserted in the newly allocated space for the vector. Hence, the cost of the fifth insertion is  $4 + 1$ . But to execute this insertion, two units allocated for the fifth insertion are available plus one unit left from the previous fourth insertion. This means that this operation is two units short to pay for itself. Thus, in the Units Left column,  $-2$  is entered to indicate the debt of two units. The table indicates that the debt decreases and becomes zero, one cheap insertion away from the next expensive insertion. This means that the operations are almost constantly executed in the red, and more important, if a sequence of operations finishes before the debt is paid off, then the balance indicated by amortized analysis is negative, which is inadmissible in the case of algorithm analysis. Therefore, the next best solution is to assume that

$$\text{amCost}(\text{push}(x)) = 3$$

The table in Figure 2.6b indicates that we are never in debt and that the choice of three units for amortized cost is not excessive because right after an expensive insertion, the accumulated units are almost depleted.

In this example, the choice of a constant function for amortized cost is adequate, but usually it is not. Define as *potential* a function that assigns a number to a

**FIGURE 2.6** Estimating the amortized cost.

(a)					(b)				
Size	Capacity	Amortized Cost	Cost	Units Left	Size	Capacity	Amortized Cost	Cost	Units Left
0	0				0	0			
1	1	2	0 + 1	1	1	1	3	0 + 1	2
2	2	2	1 + 1	1	2	2	3	1 + 1	3
3	4	2	2 + 1	0	3	4	3	2 + 1	3
4	4	2	1	1	4	4	3	1	5
5	8	2	4 + 1	-2	5	8	3	4 + 1	3
6	8	2	1	-1	6	8	3	1	5
7	8	2	1	0	7	8	3	1	7
8	8	2	1	1	8	8	3	1	9
9	16	2	8 + 1	-6	9	16	3	8 + 1	3
10	16	2	1	-5	10	16	3	1	5
:	:	:	:	:	:	:	:	:	:
16	16	2	1	1	16	16	3	1	17
17	32	2	16 + 1	-14	17	32	3	16 + 1	3
18	32	2	1	-13	18	32	3	1	5
:	:	:	:	:	:	:	:	:	:

particular state of a data structure  $ds$  that is a subject of a sequence of operations. The amortized cost is defined as a function

$$amCost(op_i) = cost(op_i) + potential(ds_i) - potential(ds_{i-1})$$

which is the real cost of executing the operation  $op_i$  plus the change in potential in the data structure  $ds$  as a result of execution of  $op_i$ . This definition holds for one single operation of a sequence of  $m$  operations. If amortized costs for all the operations are added, then the amortized cost for the sequence

$$\begin{aligned} amCost(op_1, \dots, op_m) &= \sum_{i=1}^m (cost(op_i) + potential(ds_i) - potential(ds_{i-1})) \\ &= \sum_{i=1}^m (cost(op_i) + potential(ds_m) - potential(ds_0)) \end{aligned}$$

In most cases, the potential function is initially zero and is always nonnegative so that amortized time is an upper bound of real time. This form of amortized cost is used later in the book.

Amortized cost of including new elements in a vector can now be phrased in terms of the potential function defined as

$$\text{potential}(\text{vector}_i) = \begin{cases} 0 & \text{if } \text{size}_i = \text{capacity}_i \text{ (vector is full)} \\ 2\text{size}_i - \text{capacity}_i & \text{otherwise} \end{cases}$$

To see that the function works as intended, consider three cases. The first case is when a cheap pushing follows cheap pushing (vector is not extended right before the current push and is not extended as a consequence of the current push) and

$$\text{amCost}(\text{push}_i()) = 1 + 2\text{size}_{i-1} + 2 - \text{capacity}_{i-1} - 2\text{size}_{i-1} + \text{capacity}_i = 3$$

because the capacity does not change,  $\text{size}_i = \text{size}_{i-1} + 1$ , and the actual cost equals 1. For expensive pushing following cheap pushing,

$$\text{amCost}(\text{push}_i()) = \text{size}_{i-1} + 2 + 0 - 2\text{size}_{i-1} + \text{capacity}_{i-1} = 3$$

because  $\text{size}_{i-1} + 1 = \text{capacity}_{i-1}$  and the actual cost equals  $\text{size}_i + 1 = \text{size}_{i-1} + 2$ , which is the cost of copying the vector elements plus adding the new element. For cheap pushing following expensive pushing,

$$\text{amCost}(\text{push}_i()) = 1 + 2\text{size}_i - \text{capacity}_i - 0 = 3$$

because  $2(\text{size}_i - 1) = \text{capacity}_i$  and actual cost equals 1. Note that the fourth case, expensive pushing following expensive pushing, occurs only twice, when capacity changes from zero to one and from one to zero. In both cases, amortized cost equals 3.

## 2.10 NP-COMPLETENESS

A *deterministic* algorithm is a uniquely defined (determined) sequence of steps for a particular input; that is, given an input and a step during execution of the algorithm, there is only one way to determine the next step that the algorithm can make. A *nondeterministic* algorithm is an algorithm that can use a special operation that makes a guess when a decision is to be made. Consider the nondeterministic version of binary search.

If we try to locate number  $k$  in an unordered array of numbers, then the algorithm first accesses the middle element  $m$  of the array. If  $m = k$ , then the algorithm returns  $m$ 's position; if not, the algorithm makes a guess concerning which way to go to continue: to the left of  $m$  or to its right. A similar decision is made at each stage: If number  $k$  is not located, continue in one of the two halves of the currently scrutinized subarray. It is easy to see that such a guessing very easily may lead us astray, so we need to endow the machine with the power of making correct guesses. However, an implementation of this nondeterministic algorithm would have to try, in the worst case, all the possibilities. One way to accomplish it is by requiring that the decision in each iteration is in reality this: if  $m \neq k$ , then go both to the right and to the left of  $m$ . In this way, a tree is created that represents the decisions made by the algorithm (Johnson &

Papadimitriou p. 53). The algorithm solves the problem, if any of the branches allows us to locate  $k$  in the array that includes  $k$  and if no branch leads to such a solution when  $k$  is not in the array.

A *decision problem* has two answers, call them “yes” and “no.” A decision problem is given by the set of all instances of the problem and the set of instances for which the answer is “yes.” Many optimization problems do not belong to that category (“find the minimum  $x$  for which . . .”) but in most cases they can be converted to decision problems (“is  $x$ , for which . . . , less than  $k$ ?”).

Generally, a nondeterministic algorithm solves a decision problem if it answers it in the affirmative and there is a path in the tree that leads to a yes answer, and it answers it in the negative if there is no such path. A nondeterministic algorithm is considered polynomial if a number of steps leading to an affirmative answer in a decision tree is  $O(n^k)$ , where  $n$  is the size of the problem instance.

Most of the algorithms analyzed in this book are polynomial-time algorithms; that is, their running time in the worst case is  $O(n^k)$  for some  $k$ . Problems that can be solved with such algorithms are called *tractable* and the algorithms are considered *efficient*.

A problem belongs to the class of P problems if it can be solved in polynomial time with a deterministic algorithm. A problem belongs to the class of NP problems if it can be solved in polynomial time with a nondeterministic algorithm. P problems are obviously tractable. NP problems are also tractable, but only when nondeterministic algorithms are used.

Clearly,  $P \subseteq NP$ , because deterministic algorithms are those nondeterministic algorithms that do not use nondeterministic decisions. It is also believed that  $P \neq NP$ ; that is, there exist problems with nondeterministic polynomial algorithms that cannot be solved with deterministic polynomial algorithms. This means that on deterministic Turing machines they are executed in nonpolynomial time and thus they are intractable. The strongest argument in favor of this conviction is the existence of NP-complete problems. But first we need to define the concept of reducibility of algorithms.

A problem  $P_1$  is reducible to another problem  $P_2$  if there is a way of encoding instances  $x$  of  $P_1$  as instances  $y = r(x)$  of  $P_2$  using a *reduction function*  $r$  executed with a *reduction algorithm*; that is, for each  $x$ ,  $x$  is an instance of  $P_1$  iff  $y = r(x)$  is an instance of  $P_2$ . Note that reducibility is not a symmetric relation:  $P_1$  can be reducible to  $P_2$  but not necessarily vice versa; that is, each instance  $x$  of  $P_1$  should have a counterpart  $y$  of  $P_2$ , but there may be instances  $y$  of  $P_2$  onto which no instances  $x$  of  $P_1$  are mapped with the function  $r$ . Therefore,  $P_2$  can be considered a harder problem than  $P_1$ .

The reason for the reduction is that if the value  $r(x)$  for any  $x$  can be found efficiently (in polynomial time), then an efficient solution for  $y$  can be efficiently transformed into an efficient solution of  $x$ . Also, if there is no efficient algorithm for  $x$ , then there is no efficient solution for  $y$ .

A problem is called *NP-complete* if it is NP (it can be solved efficiently by a nondeterministic polynomial algorithm) and every NP problem can be polynomially reduced to this problem. Because reducibility is a transitive relation, we can also say that an NP problem  $P_1$  is NP-complete if there is an NP-complete problem  $P_2$  that is polynomially reducible to  $P_1$ . In this way, all NP-complete problems are computationally equivalent; that is, if an NP-complete problem can be solved with a deterministic polynomial algorithm, then so can be all NP-complete problems, and thus  $P = NP$ . Also, if any problem in NP is intractable, then all NP-complete problems are intractable.

The reduction process uses an NP-complete problem to show that another problem is also NP-complete. There must be, however, at least one problem directly proven to be NP-complete by other means than reduction to make the reduction process possible. A problem that was shown by Stephen Cook to be in that category is the satisfiability problem.

The *satisfiability problem* concerns Boolean expressions in conjunctive normal form (CNF). An expression is in CNF if it is a conjunction of alternatives where each alternative involves Boolean variables and their negations, and each variable is either true or false. For example,

$$(x \vee y \vee z) \wedge (w \vee x \vee \neg y \vee z) \wedge (\neg w \vee \neg y)$$

is in CNF. A Boolean expression is *satisfiable* if there exists an assignment of values true and false that renders the entire expression true. For example, our expression is satisfiable for  $x = \text{false}$ ,  $y = \text{false}$ , and  $z = \text{true}$ . The satisfiability problem consists of determining whether a Boolean expression is satisfiable (the value assignments do not have to be given). The problem is NP, because assignments can be guessed and then the expression tested for satisfiability in polynomial time.

Cook proves that the satisfiability problem is NP-complete by using a theoretical concept of the Turing machine that can perform nondeterministic decisions (make good guesses). Operations of that machine are then described in terms of Boolean expressions, and it is shown that the expression is satisfiable iff the Turing machine terminates for a particular input (for the proof, see Appendix B).

To illustrate the reduction process, consider the *three-satisfiability problem*, which is the satisfiability problem in the case when each alternative in a Boolean expression in CNF includes only three different variables. We claim that the problem is NP-complete. The problem is NP, because a guessed assignment of truth values to variables in a Boolean expression can be verified in polynomial time. We show that the three-satisfiability problem is NP-complete by reducing it to the satisfiability problem. The reduction process involves showing that an alternative with any number of Boolean variables can be converted into a conjunction of alternatives, each alternative with three Boolean variables only. This is done by introducing new variables. Consider an alternative

$$A = (p_1 \vee p_2 \vee \dots \vee p_k)$$

for  $k \geq 4$  where  $p_i \in \{x_i, \neg x_i\}$ . With new variables  $y_1, \dots, y_{k-3}$ , we transform  $A$  into

$$A' = (p_1 \vee p_2 \vee y_1) \wedge (p_3 \vee \neg y_1 \vee y_2) \wedge (p_4 \vee \neg y_2 \vee y_3) \wedge \dots \wedge (p_{k-2} \vee \neg y_{k-4} \vee y_{k-3}) \wedge (p_{k-1} \vee p_k \vee \neg y_{k-3})$$

If the alternative  $A$  is satisfiable, then at least one term  $p_i$  is true, so the values of  $y_j$ 's can be so chosen that  $A'$  is true: if  $p_i$  is true, then we set  $y_1, \dots, y_{i-2}$  to true and the remaining  $y_{i-1}, \dots, y_{k-3}$  to false. Conversely, if  $A'$  is satisfiable, then at least one  $p_i$  must be true, because if all  $p_i$ 's are false, then the expression

$$A' = (\text{false} \vee \text{false} \vee y_1) \wedge (\text{false} \vee \neg y_1 \vee y_2) \wedge (\text{false} \vee \neg y_2 \vee y_3) \wedge \dots \wedge (\text{false} \vee \text{false} \vee \neg y_{k-3})$$

has the same truth value as the expression

$$(y_1) \wedge (\neg y_1 \vee y_2) \wedge (\neg y_2 \vee y_3) \wedge \dots \wedge (\neg y_{k-3})$$

which cannot be true for any choice of values for  $y_j$ 's, thus is not satisfiable.

## 2.11 EXERCISES

1. Explain the meaning of the following expressions:
  - a.  $f(n)$  is  $O(1)$ .
  - b.  $f(n)$  is  $\Theta(1)$ .
  - c.  $f(n)$  is  $n^{O(1)}$ .
2. Assuming that  $f_1(n)$  is  $O(g_1(n))$  and  $f_2(n)$  is  $O(g_2(n))$ , prove the following statements:
  - a.  $f_1(n) + f_2(n)$  is  $O(\max(g_1(n), g_2(n)))$ .
  - b. If a number  $k$  can be determined such that for all  $n > k$ ,  $g_1(n) \leq g_2(n)$ , then  $O(g_1(n)) + O(g_2(n))$  is  $O(g_2(n))$ .
  - c.  $f_1(n) * f_2(n)$  is  $O(g_1(n) * g_2(n))$  (rule of product).
  - d.  $O(cg(n))$  is  $O(g(n))$ .
  - e.  $c$  is  $O(1)$ .
3. Prove the following statements:
  - a.  $\sum_{i=1}^n i^2$  is  $O(n^3)$  and more generally,  $\sum_{i=1}^n i^k$  is  $O(n^{k+1})$ .
  - b.  $an^k/\lg n$  is  $O(n^k)$  but  $an^k/\lg n$  is not  $\Theta(n^k)$ .
  - c.  $n^{1.1} + n \lg n$  is  $\Theta(n^{1.1})$ .
  - d.  $2^n$  is  $O(n!)$  and  $n!$  is not  $O(2^n)$ .
  - e.  $2^{n+a}$  is  $O(2^n)$ .
  - f.  $2^{2n+a}$  is not  $O(2^n)$ .
  - g.  $2^{\sqrt{\lg n}}$  is  $O(n^a)$ .
4. Make the same assumptions as in Exercise 2 and, by finding counterexamples, refute the following statements:
  - a.  $f_1(n) - f_2(n)$  is  $O(g_1(n) - g_2(n))$ .
  - b.  $f_1(n)/f_2(n)$  is  $O(g_1(n)/g_2(n))$ .
5. Find functions  $f_1$  and  $f_2$  such that both  $f_1(n)$  and  $f_2(n)$  are  $O(g(n))$ , but  $f_1(n)$  is not  $O(f_2)$ .
6. Is it true that
  - a. if  $f(n)$  is  $\Theta(g(n))$ , then  $2^{f(n)}$  is  $\Theta(2^{g(n)})$ ?
  - b.  $f(n) + g(n)$  is  $\Theta(\min(f(n), g(n)))$ ?
  - c.  $2^{na}$  is  $O(2^n)$ ?
7. The algorithm presented in this chapter for finding the length of the longest subarray with the numbers in increasing order is inefficient, because there is no need to continue to search for another array if the length already found is greater than the length of the subarray to be analyzed. Thus, if the entire array is already in order, we can discontinue the search right away, converting the worst case into the best. The change needed is in the outer loop, which now has one more test:

```
for (i = 0, length = 1; i < n-1 && length < n==i; i++)
```

What is the worst case now? Is the efficiency of the worst case still  $O(n^2)$ ?

8. Find the complexity of the function used to find the  $k$ th smallest integer in an un-ordered array of integers

```
int selectkth(int a[], int k, int n) {
    int i, j, mini, tmp;
    for (i = 0; i < k; i++) {
        mini = i;
        for (j = i+1; j < n; j++)
            if (a[j]<a[mini])
                mini = j;
        tmp = a[i];
        a[i] = a[mini];
        a[mini] = tmp;
    }
    return a[k-1];
}
```

9. Determine the complexity of the following implementations of the algorithms for adding, multiplying, and transposing  $n \times n$  matrices:

```
for (i = 0; i < n; i++)
    for (j = 0; j < n; j++)
        a[i][j] = b[i][j] + c[i][j];

for (i = 0; i < n; i++)
    for (j = 0; j < n; j++)
        for (k = a[i][j] = 0; k < n; k++)
            a[i][j] += b[i][k] * c[k][j];

for (i = 0; i < n - 1; i++)
    for (j = i+1; j < n; j++) {
        tmp = a[i][j];
        a[i][j] = a[j][i];
        a[j][i] = tmp;
    }
```

10. Find the computational complexity for the following four loops:

```
a. for (cnt1 = 0, i = 1; i <= n; i++)
    for (j = 1; j <= n; j++)
        cnt1++;

b. for (cnt2 = 0, i = 1; i <= n; i++)
    for (j = 1; j <= i; j++)
        cnt2++;
```

```

c.   for (cnt3 = 0, i = 1; i <= n; i *= 2)
        for (j = 1; j <= n; j++)
            cnt3++;
d.   for (cnt4 = 0, i = 1; i <= n; i *= 2)
        for (j = 1; j <= i; j++)
            cnt4++;

```

11. Find the average case complexity of sequential search in an array if the probability of accessing the last cell equals  $\frac{1}{2}$ , the probability of the next to last cell equals  $\frac{1}{4}$ , and the probability of locating a number in any of the remaining cells is the same and equal to  $\frac{1}{4(n-2)}$ .
12. Consider a process of incrementing a binary  $n$ -bit counter. An increment causes some bits to be flipped: Some 0s are changed to 1s, and some 1s to 0s. In the best case, counting involves only one bit switch; for example, when 000 is changed to 001, sometimes all the bits are changed, as when incrementing 011 to 100.

Number	Flipped Bits
000	
001	1
010	2
011	1
100	3
101	1
110	2
111	1

Using worst case assessment, we may conclude that the cost of executing  $m = 2^n - 1$  increments is  $O(mn)$ . Use amortized analysis to show that the cost of executing  $m$  increments is  $O(m)$ .

13. How can you convert a satisfiability problem into a three-satisfiability problem for an instance when an alternative in a Boolean expression has two variables? One variable?



## BIBLIOGRAPHY

### *Computational Complexity*

Hartmanis, Juris, and Hopcroft, John E., “An Overview of the Theory of Computational Complexity,” *Journal of the ACM* 18 (1971), 444–475.

Hartmanis, Juris, and Stearns, Richard E., “On the Computational Complexity of Algorithms,” *Transactions of the American Mathematical Society* 117 (1965), 284–306.

Preparata, Franco P., “Computational Complexity,” in Pollack, S. V. (ed.), *Studies in Computer Science*, Washington, DC: The Mathematical Association of America, 1982, 196–228.

### *Big-O, $\Omega$ , and $\Theta$ Notations*

Brassard, G., “Crusade for a Better Notation,” *SIGACT News* 17 (1985), 60–64.

Knuth, Donald, *The Art of Computer Programming, Vol. 2: Seminumerical Algorithms*, Reading, MA: Addison-Wesley, 1998.

Knuth, Donald, “Big Omicron and Big Omega and Big Theta,” *SIGACT News*, April–June, 8 (1976), 18–24.

Vitanyi, P. M. B., and Meertens, L., “Big Omega versus the Wild Functions,” *SIGACT News* 16 (1985), 56–59.

### *OO Notation*

Manber, Udi, *Introduction to Algorithms: A Creative Approach*, Reading, MA: Addison-Wesley, 1989.

### *Amortized Analysis*

Heileman, Gregory L., *Discrete Structures, Algorithms, and Object-Oriented Programming*, New York: McGraw-Hill, 1996, Chs. 10–11.

Tarjan, Robert E., “Amortized Computational Complexity,” *SIAM Journal on Algebraic and Discrete Methods* 6 (1985), 306–318.

### *NP-Completeness*

Cook, Stephen A., “The Complexity of Theorem-Proving Procedures,” *Proceedings of the Third Annual ACM Symposium on Theory of Computing*, 1971, 151–158.

Garey, Michael R., and Johnson, David S., *Computers and Intractability: A Guide to the Theory of NP-Completeness*, San Francisco: Freeman, 1979.

Johnson, D. S., and Papadimitriou, C. H., “Computational Complexity,” in Lawler, E. L., Lenstra, J. K., Rinnoy, Kan A. H. G., and Shmoys, D. B. (eds.), *The Traveling Salesman Problem*, New York: Wiley, 1985, 37–85.

Karp, Richard M., “Reducibility Among Combinatorial Problems,” in R. E. Miller and J. W. Thatcher (eds.), *Complexity of Computer Computations*, New York: Plenum Press, 1972, 85–103.

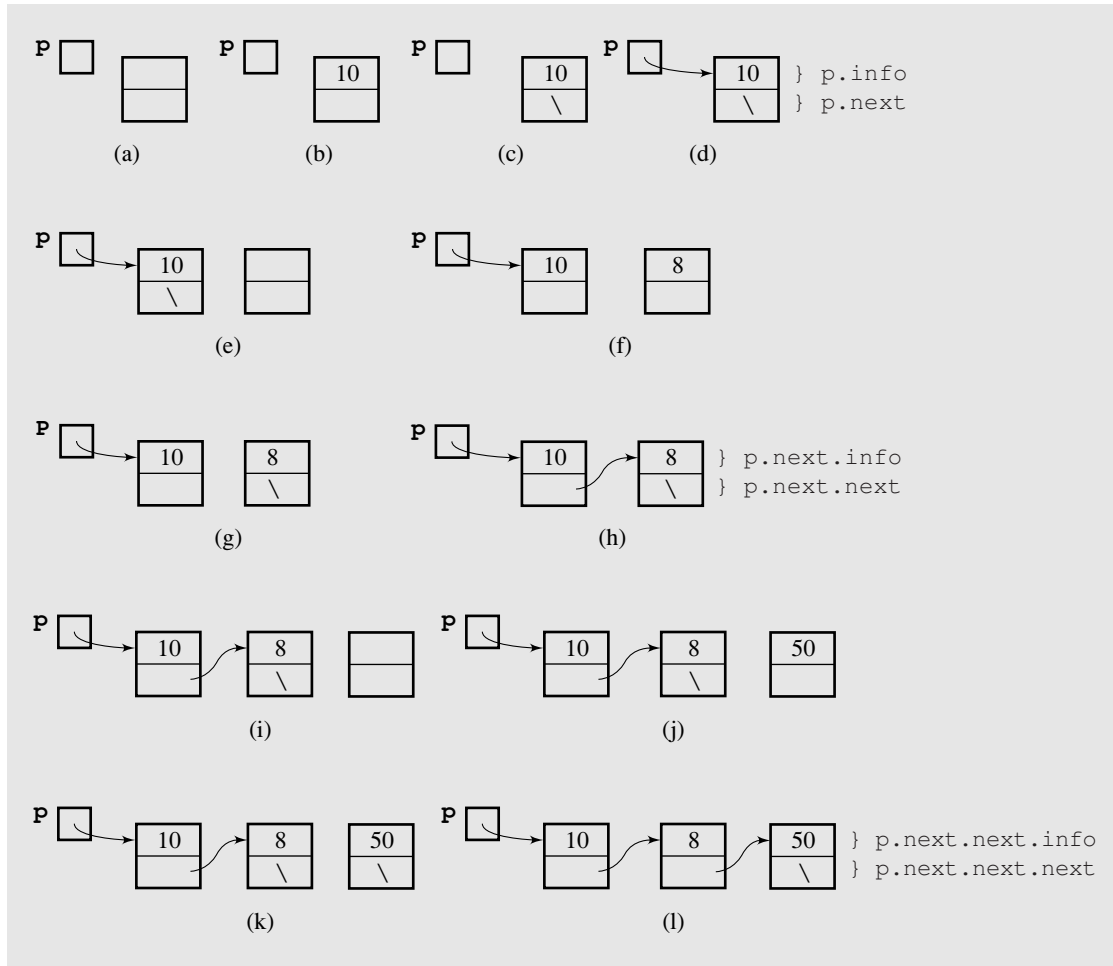
# 3

## Linked Lists

An array is a very useful data structure provided in programming languages. However, it has at least two limitations: (1) changing the size of the array requires creating a new array and then copying all data from the array with the old size to the array with the new size and (2) the data in the array are next to each other sequentially in memory, which means that inserting an item inside the array requires shifting some other data in this array. This limitation can be overcome by using *linked structures*. A linked structure is a collection of nodes storing data and links to other nodes. In this way, nodes can be located anywhere in memory, and passing from one node of the linked structure to another is accomplished by storing the reference(s) to other node(s) in the structure. Although linked structures can be implemented in a variety of ways, the most flexible implementation is by using a separate object for each node.

### 3.1 SINGLY LINKED LISTS

If a node contains a data field that is a reference to another node, then many nodes can be strung together using only one variable to access the entire sequence of nodes. Such a sequence of nodes is the most frequently used implementation of a *linked list*, which is a data structure composed of nodes, each node holding some information and a reference to another node in the list. If a node has a link only to its successor in this sequence, the list is called a *singly linked list*. An example of such a list is shown in Figure 3.1. Note that only one variable *p* is used to access any node in the list. The last node on the list can be recognized by the null reference field.

**FIGURE 3.1** A singly linked list.

Each node in the list in Figure 3.1 is an instance of the following class definition:

```
public class IntSLLNode {
    public int info;
    public IntSLLNode next;
    public IntSLLNode(int i) {
        this(i,null);
    }
    public IntSLLNode(int i, IntSLLNode n) {
        info = i; next = n;
    }
}
```

A node includes two data fields: `info` and `next`. The `info` field is used to store information, and this field is important to the user. The `next` field is used to link together nodes to form a linked list. It is an auxiliary field used to maintain the linked list. It is indispensable for implementation of the linked list, but less important (if at all) from the user's perspective. Note that `IntSLLNode` is defined in terms of itself because one data field, `next`, is a reference to a node of the same type that is just being defined. Objects that include such a data field are called self-referential objects.

The definition of a node also includes two constructors. The second constructor takes two arguments, one to initialize the `info` field and another to initialize the `next` field. The first constructor takes one argument and is defined in terms of the second constructor. The reserved word `this` is used to refer to the current object, and this word can appear anywhere this object can be used. Therefore, `this(i, null)` means the same as `IntSLLNode(i, null)`; that is, the first constructor invokes the second constructor by having `null` as the value of the second argument. As the result of executing the first constructor, the `info` field is initialized to `i` and the `next` field to `null`.

Now, let us create the linked list in Figure 3.11. One way to create this three-node linked list is to first generate the node containing number 10, then the node containing 8, and finally the node containing 50. Each node has to be initialized properly and incorporated into the list. To see it, each step is illustrated in Figure 3.1 separately.

First, we execute the declaration and assignment

```
IntSLLNode p = new IntSLLNode(10);
```

which creates the first node on the list and makes the variable `p` a reference to this node. This is done in four steps. In the first step, a new `IntSLLNode` is created (Figure 3.1a), in the second step, the `info` field of this node is set to 10 (Figure 3.1b), and in the third step, the node's `next` field is set to `null` (Figure 3.1c). The null reference is marked with a slash in the reference field. Note that the slash in the `next` field is not a slash character. The second and third steps—initialization of fields of the new `IntSLLNode`—are performed by invoking the constructor `IntSLLNode(10)`, which in turn invokes the constructor `IntSLLNode(10, null)`. The fourth step is making `p` a reference to the newly created node (Figure 3.1d). This reference is the address of the node, and it is shown as an arrow from the variable `p` to the new node.

The second node is created with the assignment

```
p.next = new IntSLLNode(8);
```

where `p.next` is the `next` field of the node pointed to by `p` (Figure 3.1d). As before, four steps are executed:

1. A new node is created (Figure 3.1e).
2. The constructor assigns the number 8 to the `info` field of this node (Figure 3.1f).
3. The constructor assigns `null` to its `next` field (Figure 3.1g).
4. The new node is included in the list by making the `next` field of the first node a reference to the new node (Figure 3.1h).

The linked list is now extended by adding a third node with the assignment

```
p.next.next = new IntSLLNode(50);
```

where `p.next.next` is the `next` field of the second node. This cumbersome notation has to be used because the list is accessible only through the variable `p`.

In processing the third node, four steps are also executed: creating the node (Figure 3.1i), initializing its two fields (Figure 3.1j–k), and then incorporating the node in the list (Figure 3.1l).

Our linked list example illustrates a certain inconvenience in using references: The longer the linked list, the longer the chain of `nexts` to access the nodes at the end of the list. In this example, `p.next.next.next` allows us to access the `next` field of the 3rd node on the list. But what if it were the 103rd or, worse, the 1,003rd node on the list? Typing 1,003 `nexts`, as in `p.next...next`, would be daunting. If we missed one `next` in this chain, then a wrong assignment is made. Also, the flexibility of using linked lists is diminished. Therefore, other ways of accessing nodes in linked lists are needed. One way is always to keep two references to the linked list: one to the first node and one to the last, as shown in Figure 3.2.

**FIGURE 3.2** An implementation of a singly linked list of integers.

```

//***** IntSLLNode.java *****
//          a node in an integer singly linked list class

public class IntSLLNode {
    public int info;
    public IntSLLNode next;
    public IntSLLNode(int i) {
        this(i,null);
    }
    public IntSLLNode(int i, IntSLLNode n) {
        info = i; next = n;
    }
}

//***** IntSLLList.java *****
//          singly linked list class to store integers

public class IntSLLList {
    protected IntSLLNode head, tail;
    public IntSLLList() {
        head = tail = null;
    }
    public boolean isEmpty() {
        return head == null;
    }
}

```

*Continues*

**FIGURE 3.2** (continued)

```
public void addToHead(int el) {
    head = new IntSLLNode(el,head);
    if (tail == null)
        tail = head;
}
public void addToTail(int el) {
    if (!isEmpty()) {
        tail.next = new IntSLLNode(el);
        tail = tail.next;
    }
    else head = tail = new IntSLLNode(el);
}
public int deleteFromHead() { // delete the head and return its info;
    int el = head.info;
    if (head == tail) // if only one node on the list;
        head = tail = null;
    else head = head.next;
    return el;
}
public int deleteFromTail() { // delete the tail and return its info;
    int el = tail.info;
    if (head == tail) // if only one node on the list;
        head = tail = null;
    else { // if more than one node on the list,
        IntSLLNode tmp; // find the predecessor of tail;
        for (tmp = head; tmp.next != tail; tmp = tmp.next);
        tail = tmp; // the predecessor of tail becomes tail;
        tail.next = null;
    }
    return el;
}
public void printAll() {
    for (IntSLLNode tmp = head; tmp != null; tmp = tmp.next)
        System.out.print(tmp.info + " ");
}
public boolean isInList(int el) {
    IntSLLNode tmp;
    for (tmp = head; tmp != null && tmp.info != el; tmp = tmp.next);
    return tmp != null;
}
```

**FIGURE 3.2** (continued)

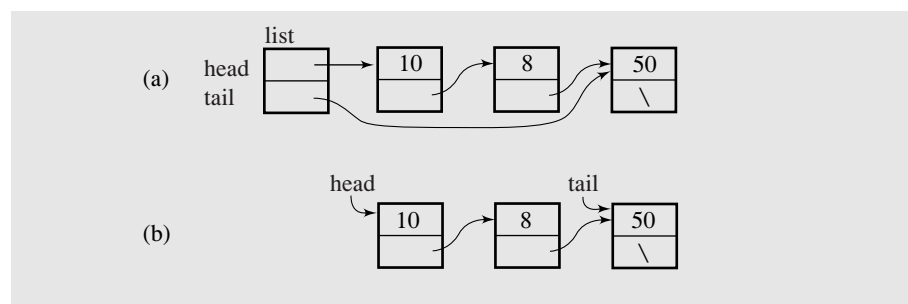
```

public void delete(int el) { // delete the node with an element el;
    if (!isEmpty())
        if (head == tail && el == head.info) // if only one
            head = tail = null; // node on the list;
        else if (el == head.info) // if more than one node on the
            head = head.next; // list; and el is in the head node;
        else { // if more than one node in the list
            IntSLLNode pred, tmp; // and el is in a non-head node;
            for (pred = head, tmp = head.next;
                tmp != null && tmp.info != el;
                pred = pred.next, tmp = tmp.next);
            if (tmp != null) { // if el was found;
                pred.next = tmp.next;
                if (tmp == tail) // if el is in the last node;
                    tail = pred;
            }
        }
    }
}

```

The singly linked list implementation in Figure 3.2 uses two classes: one class, `IntSLLNode`, for nodes of the list, and another, `IntSLLList`, for access to the list. The class `IntSLLList` defines two data fields, `head` and `tail`, which are references to the first and the last nodes of a list. An example of a list is shown in Figure 3.3. The list is declared with the statement

```
IntSLLList list = new IntSLLList();
```

**FIGURE 3.3** A singly linked list of integers.

The first object in Figure 3.3a is not part of the list; it allows for having access to the list. For simplicity, in subsequent figures, only nodes belonging to the list are shown, the access node is omitted, and the `head` and `tail` fields are marked as in Figure 3.3b.

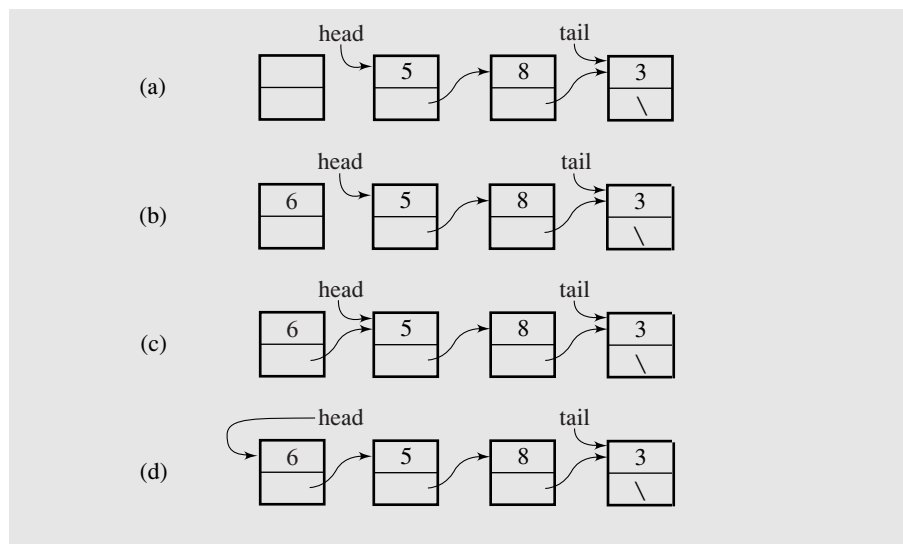
Besides the `head` and `tail` fields, the class `IntSLList` also defines methods that allow us to manipulate the lists. We now look more closely at some basic operations on linked lists presented in Figure 3.2.

### 3.1.1 Insertion

Adding a node at the beginning of a linked list is performed in four steps.

1. An empty node is created. It is empty in the sense that the program performing insertion does not assign any values to the fields of the node (Figure 3.4a).
2. The node's `info` field is initialized to a particular integer (Figure 3.4b).
3. Because the node is being included at the front of the list, the `next` field becomes a reference to the first node on the list; that is, the current value of `head` (Figure 3.4c).
4. The new node precedes all the nodes on the list, but this fact has to be reflected in the value of `head`; otherwise, the new node is not accessible. Therefore, `head` is updated to become the reference to the new node (Figure 3.4d).

**FIGURE 3.4** Inserting a new node at the beginning of a singly linked list.



The four steps are executed by the method `addToHead()` (Figure 3.2). The method executes the first three steps indirectly by calling the constructor `Node(e1, head)`. The last step is executed directly in the method by assigning the address (reference) of the newly created node to `head`.

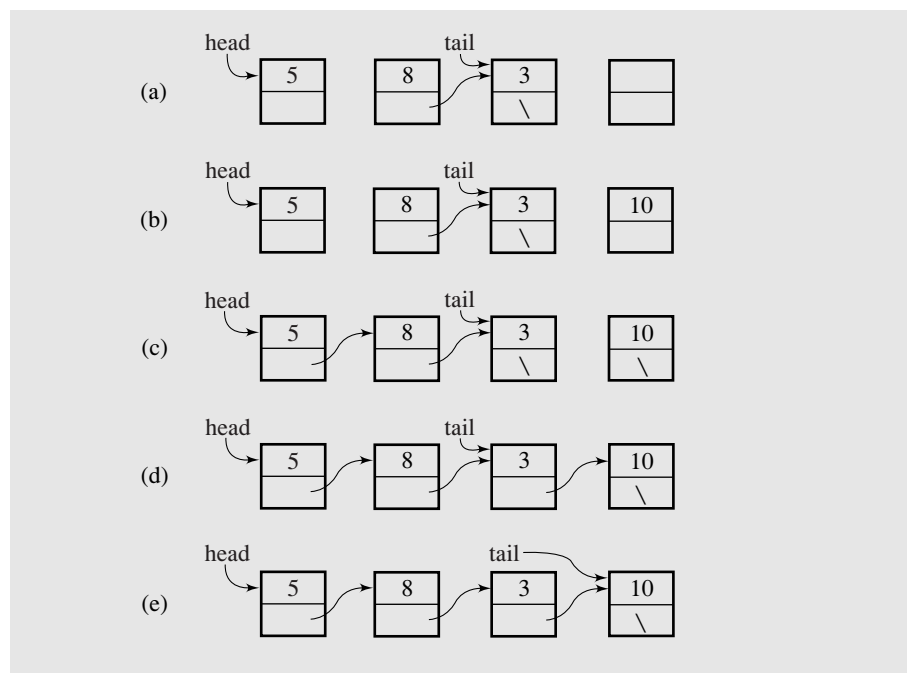


The method `addToHead()` singles out one special case, namely, inserting a new node in an empty linked list. In an empty linked list, both `head` and `tail` are null; therefore, both become references to the only node of the new list. When inserting in a nonempty list, only `head` needs to be updated.

The process of adding a new node to the end of the list has five steps.

1. An empty node is created (Figure 3.5a).
2. The node's `info` field is initialized to an integer `e1` (Figure 3.5b).
3. Because the node is being included at the end of the list, the `next` field is set to null (Figure 3.5c).
4. The node is now included in the list by making the `next` field of the last node of the list a reference to the newly created node (Figure 3.5d).
5. The new node follows all the nodes of the list, but this fact has to be reflected in the value of `tail`, which now becomes the reference to the new node (Figure 3.5e).

**FIGURE 3.5** Inserting a new node at the end of a singly linked list.



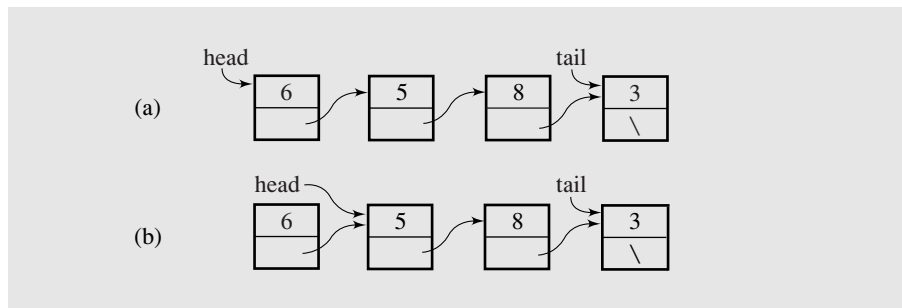
All these steps are executed in the `if` clause of the `addToTail()` method (Figure 3.2). The `else` clause of this method is executed only if the linked list is empty. If this case were not included, the program would crash because in the `if` clause we make an assignment to the `next` field of the node referred by `tail`. In the case of an empty linked list, it is a reference to a nonexistent field of a nonexistent node, which leads to raising the `NullPointerException`.

The process of inserting a new node at the beginning of the list is very similar to the process of inserting a node at the end of the list. This is because the implementation of `IntSLList` uses two reference fields: `head` and `tail`. For this reason, both `addToHead()` and `addToTail()` can be executed in constant time  $O(1)$ ; that is, regardless of the number of nodes in the list, the number of operations performed by these two methods does not exceed some constant number  $c$ . Note that because the `head` reference allows us to have access to a linked list, the `tail` reference is not indispensable; its only role is to have immediate access to the last node of the list. With this access, a new node can be added easily at the end of the list. But as illustrated by a linked list implementation of `SLList` in Figure 3.9 later in the chapter, the `tail` reference does not have to be used. In this case, adding a node at the end of the list is more complicated because we first have to reach the last node in order to attach a new node to it. This requires scanning the list and requires  $O(n)$  steps to finish; that is, it is linearly proportional to the length of the list. The process of scanning lists is illustrated when discussing deletion of the last node.

### 3.1.2 Deletion

One deletion operation consists of deleting a node at the beginning of the list and returning the value stored in it. This operation is implemented by the method `deleteFromHead()`. In this operation the information from the first node is temporarily stored in a local variable `e1`, and then `head` is reset so what was the second node becomes the first node. In this way, the former first node is abandoned to be processed later by the garbage collector (Figure 3.6). Note that the former first node still accesses the linked list, but the node itself is inaccessible. Thus, it is considered nonexistent. Because the head node is immediately accessible, `deleteFromHead()` takes constant time  $O(1)$  to perform its task.

**FIGURE 3.6** Deleting a node from the beginning of a singly linked list.



Unlike before, there are now two special cases to consider. One case is when we attempt to remove a node from an empty linked list. If such an attempt is made, the program crashes because of the `NullPointerException`, which we don't want to happen. The caller should also know that such an attempt was made to perform a certain action. After all, if the caller expects a number to be returned from the call to

`deleteFromHead()` and no number can be returned, then the caller may be unable to accomplish some other operations.

There are at least two ways of solving the problem. One solution is to use the `throws` clause, as in

```
public int deleteFromHead() throws NullPointerException {
    . . . . .
}
```

The `throws` clause is expected to have a matching `try-catch` clause in the caller (or caller's caller, etc.), which catches the exception, as in:

```
void f() {
    . . . . .
    try {
        n = list.deleteFromHead();
    } catch (NullPointerException npe) {
        System.out.println("Empty list");
    }
}
```

This solution gives the caller a control over the abnormal situation without making it lethal to the program. The user is responsible for providing an exception handler in the form of the `try-catch` clause, with the solution appropriate to the particular case. If the clause is not provided, then the program crashes when the exception is thrown. The method `f()` may only print a message that a list is empty when an attempt is made to delete a number from an empty list, another method `g()` may assign a certain value for `n` in such a case, and yet another method `h()` may find such a situation detrimental to the program and abort the program altogether.

The idea that the user is responsible for providing an action in the case of an exception is also presumed in the implementation given in Figure 3.2. The method assumes that the list is not empty. To prevent the program from crashing, the method `isEmpty()` is added to the `IntSLList` class, and the user should use it, as in:

```
if (!list.isEmpty())
    n = list.deleteFromHead();
else do not remove;
```

Note that including a similar `if` statement in `deleteFromHead()` does not solve the problem. Consider this code:

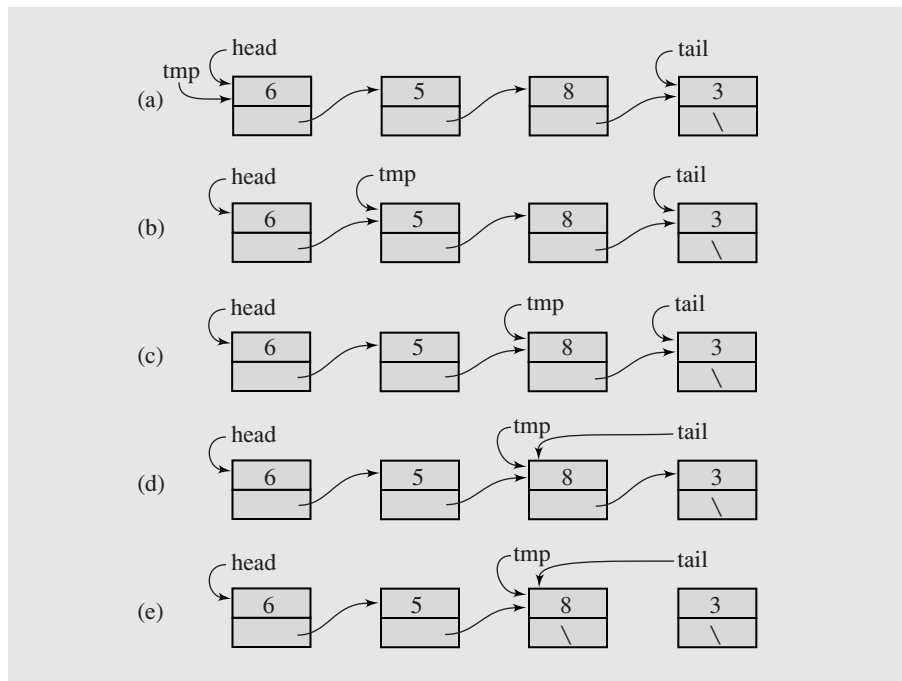
```
public int deleteFromHead() {
    if (!isEmpty()) { // if nonempty list;
        int el = head.info;
        . . . . .
        return el;
    }
    else return 0;
}
```

If an `if` statement is added, then the `else` clause must also be added; otherwise, the program does not compile because of “missing return statement.” But now, if 0 is returned, the caller does not know whether the returned 0 is the sign of failure or if it is a literal 0 retrieved from the list. To avoid any confusion, the caller must use an `if` statement to test whether the list is empty before calling `deleteFromHead()`. In this way, the test inside the method becomes redundant.

The second special case in `deleteFromHead()` is when the list has only one node to be removed. In this case, the list becomes empty, which requires setting `head` and `tail` to null.

The second deletion operation consists of deleting a node from the end of the list, and it is implemented as a method `deleteFromTail()`. The problem is that after removing a node, `tail` should refer to the new tail of the list; that is, `tail` has to be moved backward by one node. But moving backward is impossible because there is no direct link from the last node to its predecessor. Hence, this predecessor has to be found by searching from the beginning of the list and stopping right before `tail`. This is accomplished with a temporary variable `tmp` that scans the list within the `for` loop. The variable `tmp` is initialized to the head of the list, and then in each iteration of the loop, it is advanced to the next node. If the list is as in Figure 3.7a,

**FIGURE 3.7** Deleting a node from the end of a singly linked list.



then `tmp` first refers to the head node holding number 6; after executing the assignment `tmp = tmp.next`, `tmp` refers to the second node (Figure 3.7b). After the second iteration and executing the same assignment, `tmp` refers to the third node (Figure 3.7c). Because this node is also the next to last node, the loop is exited, after which `tail` becomes the reference to the next to last node (Figure 3.7d), and then the `next` field of this node is set to null (Figure 3.7e). After the last assignment, what was the last node is now detached from the list and inaccessible from it. In due course, this node is claimed by the garbage collector.

Note that in the `for` loop, a temporary variable was used to scan the list. If the loop were simplified to

```
for ( ; head.next != tail; head = head.next);
```

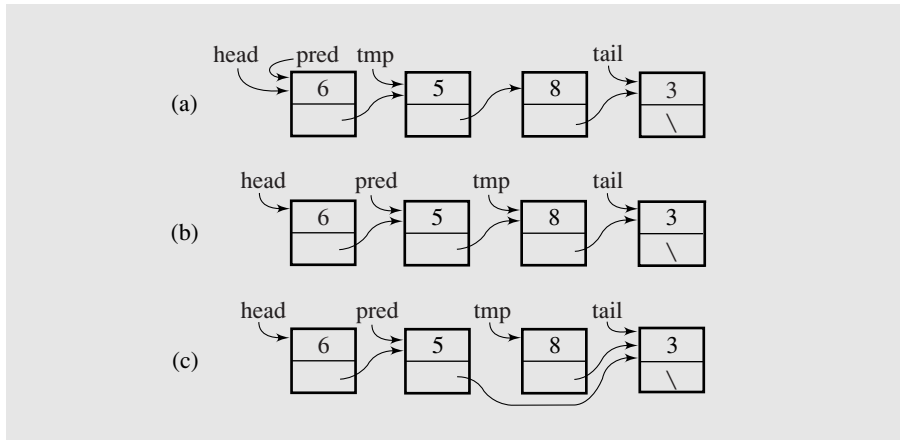
then the list is scanned only once, and the access to the beginning of the list is lost because `head` was permanently updated to the next to last node, which is about to become the last node. It is absolutely critical that, in cases such as this, a temporary variable is used so that the access to the beginning of the list is kept intact.

In removing the last node, the two special cases are the same as in `deleteFromHead()`. If the list is empty, then nothing can be removed, but what should be done in this case is decided in the user program just as in the case of `deleteFromHead()`. The second case is when a single-node list becomes empty after removing its only node, which also requires setting `head` and `tail` to null.

The most time-consuming part of `deleteFromTail()` is finding the next to last node performed by the `for` loop. It is clear that the loop performs  $n - 1$  iterations in a list of  $n$  nodes, which is the main reason this method takes  $O(n)$  time to delete the last node.

The two discussed deletion operations remove a node from the head or from the tail (that is, always from the same position) and return the integer that happens to be in the node being removed. A different approach is when we want to delete a node that holds a particular integer regardless of the position of this node in the list. It may be right at the beginning, at the end, or anywhere inside the list. Briefly, a node has to be located first and then detached from the list by linking the predecessor of this node directly to its successor. Because we do not know where the node may be, the process of finding and deleting a node with a certain integer is much more complex than the deletion operations discussed so far. The method `delete()` (Figure 3.2) is an implementation of this process.

A node is removed from inside a list by linking its predecessor to its successor. But because the list has only forward links, the predecessor of a node is not reachable from the node. One way to accomplish the task is to find the node to be removed, by first scanning the list and then scanning it again to find its predecessor. Another way is presented in `delete()`, as shown in Figure 3.8. Assume that we want to delete a node that holds the number 8. The method uses two reference variables, `pred` and `tmp`, which are initialized in the `for` loop so that they point to the first and second nodes of the list, respectively (Figure 3.8a). Because the node `tmp` has the number 5, the first iteration is executed in which both `pred` and `tmp` are advanced to the next nodes (Figure 3.8b). Because the condition of the `for` loop is now true (`tmp` points to the node with 8), the loop is exited and an assignment `pred.next = tmp.next` is executed

**FIGURE 3.8** Deleting a node from a singly linked list.

(Figure 3.8c). This assignment effectively excludes the node with 8 from the list. Although the node is still accessible from variable `tmp`, it will not be accessible after the method `delete()` is exited because `tmp` is local to the method. Hence, it ceases to exist after exiting this method. As before, the now inaccessible node with number 8 will be processed by the garbage collector.

The preceding paragraph discussed only one case. Here are the remaining cases:

1. An attempt to remove a node from an empty list, in which case the method is immediately exited.
2. Deleting the only node from a one-node linked list: Both `head` and `tail` are set to null.
3. Removing the first node of the list with at least two nodes, which requires updating `head`.
4. Removing the last node of the list with at least two nodes, leading to the update of `tail`.
5. An attempt to delete a node with a number that is not in the list: Do nothing.

It is clear that the best case for `delete()` is when the head node is to be deleted, which takes  $O(1)$  time to accomplish. The worst case is when the last node needs to be deleted, which reduces `delete()` to `deleteFromTail()` and to its  $O(n)$  performance. What is the average case? It depends on how many iterations the `for` loop executes. Assuming that any node on the list has an equal chance to be deleted, the loop performs no iteration if it is the first node, one iteration if it is the second node, . . . , and finally  $n - 1$  iterations if it is the last node. For a long sequence of deletions, one deletion requires on the average

$$\frac{0+1+\dots+(n-1)}{n} = \frac{\frac{(n-1)n}{2}}{n} = \frac{n-1}{2}$$

That is, on the average, `delete()` executes  $O(n)$  steps to finish, just like in the worst case.

### 3.1.3 Search

The insertion and deletion operations modify linked lists. The searching operation scans an existing list to learn whether a number is in it. We implement this operation with the Boolean method `isInList()`. The method uses a temporary variable `tmp` to go through the list starting from the head node. The number stored in each node is compared to the number being sought, and if the two numbers are equal, the loop is exited; otherwise, `tmp` is updated to `tmp.next` so that the next node can be investigated. After reaching the last node and executing the assignment `tmp = tmp.next`, `tmp` becomes null, which is used as an indication that the number `e1` is not in the list. That is, if `tmp` is not null, the search was discontinued somewhere inside the list because `e1` was found. That is why `isInList()` returns the result of comparison `tmp != 0`: If `tmp` is not null, `e1` was found and `true` is returned. If `tmp` is null, the search was unsuccessful and `false` is returned.

With reasoning very similar to that used to determine the efficiency of `delete()`, `isInList()` takes  $O(1)$  time in the best case and  $O(n)$  in the worst and average cases.

In the foregoing discussion, the operations on nodes have been stressed. However, a linked list is built for the sake of storing and processing information, not for the sake of itself. Therefore, the approach used in this section is limited in that the list can only store integers. If we wanted a linked list for float numbers or for arrays of numbers, then a new class has to be declared with a new set of methods, all of them resembling the ones discussed here. However, it is more advantageous to declare such a class only once without deciding in advance what type of data will be stored in it. One solution is to declare the `info` field as `Object`. This is an adequate solution if the linked list is used for the type of storage and retrieval operations that are position oriented: insert at the beginning or retrieve from the end. But for the method `delete()`, which first relies on finding a node with specific information or for such operations as retrieving the largest element, inserting the information in ascending order, or just finding a particular piece of information in the list, the type `Object` does not allow us to do it for the reasons indicated in Section 1.4: Comparison amounts to comparing references to data, not the data themselves. Hence, the desired comparison methods have to be defined each time a linked list is accommodated to storing a particular data type. This way of defining generic linked lists is shown in Figure 3.9. For the rest of the chapter, linked lists of integers are used to simplify coding and to show clearly the linked list's operations.

**FIGURE 3.9** Implementation of a generic singly linked list.

```

//***** SLLNode.java *****

public class SLLNode {
    public Object info;
    public SLLNode next;
    public SLLNode() {
        next = null;
    }
    public SLLNode(Object el) {
        info = el; next = null;
    }
    public SLLNode(Object el, SLLNode ptr) {
        info = el; next = ptr;
    }
}

/***** SLLList.java *****
 *      generic singly linked list class with head only
 */

public class SLLList {
    protected SLLNode head = null;
    public SLLList() {
    }
    public boolean isEmpty() {
        return head == null;
    }
    public Object first() {
        return head.info;
    }
    public void printAll(java.io.PrintStream out) {
        for (SLLNode tmp = head; tmp != null; tmp = tmp.next)
            out.print(tmp.info);
    }
    public void add(Object el) {
        head = new SLLNode(el,head);
    }
    public Object find(Object el) {
        SLLNode tmp = head;
        for ( ; tmp != null && !el.equals(tmp.info); tmp = tmp.next);
        if (tmp == null)
            return null;
        else return tmp.info;
    }
}

```



**FIGURE 3.9** (continued)

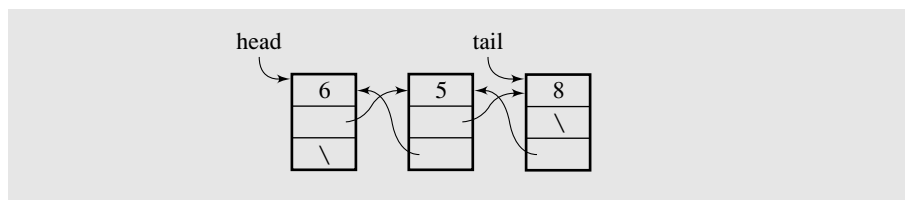
```

public Object deleteHead() { // remove the head and return its info;
    Object el = head.info;
    head = head.next;
    return el;
}
public void delete(Object el) { // find and remove el;
    if (head != null) // if nonempty list;
        if (el.equals(head.info)) // if head needs to be removed;
            head = head.next;
        else {
            SLLNode pred = head, tmp = head.next;
            for ( ; tmp != null && !(tmp.info.equals(el));
                pred = pred.next, tmp = tmp.next);
            if (tmp != null) // if found
                pred.next = tmp.next;
        }
    }
}

```

## 3.2 DOUBLY LINKED LISTS

The method `deleteFromTail()` indicates a problem inherent to singly linked lists. The nodes in such lists contain only references to the successors; therefore, there is no immediate access to the predecessors. For this reason, `deleteFromTail()` was implemented with a loop that allowed us to find the predecessor of `tail`. Although this predecessor is, so to speak, within sight, it is out of reach. We have to scan the entire list to stop right in front of `tail` to delete it. For long lists and for frequent executions of `deleteFromTail()`, this may be an impediment to swift list processing. To avoid this problem, the linked list is redefined so that each node in the list has two reference fields, one to the successor and one to the predecessor. A list of this type is called a *doubly linked list*, and is illustrated in Figure 3.10. An implementation of a doubly linked list of integers is shown in Figure 3.11.

**FIGURE 3.10** A doubly linked list.

**FIGURE 3.11** An implementation of a doubly linked list.

```

/***** IntDLLNode.java *****/

public class IntDLLNode {
    public int info;
    public IntDLLNode next, prev;
    public IntDLLNode(int el) {
        this(el,null,null);
    }
    public IntDLLNode(int el, IntDLLNode n, IntDLLNode p) {
        info = el; next = n; prev = p;
    }
}

/***** IntDLLList.java *****/

public class IntDLLList {
    private IntDLLNode head, tail;
    public IntDLLList() {
        head = tail = null;
    }
    public boolean isEmpty() {
        return head == null;
    }
    public void addToTail(int el) {
        if (!isEmpty()) {
            tail = new IntDLLNode(el,null,tail);
            tail.prev.next = tail;
        }
        else head = tail = new IntDLLNode(el);
    }
    public int removeFromTail() {
        int el = tail.info;
        if (head == tail) // if only one node in the list;
            head = tail = null;
        else { // if more than one node in the list;
            tail = tail.prev;
            tail.next = null;
        }
        return el;
    }
    . . . . .
}

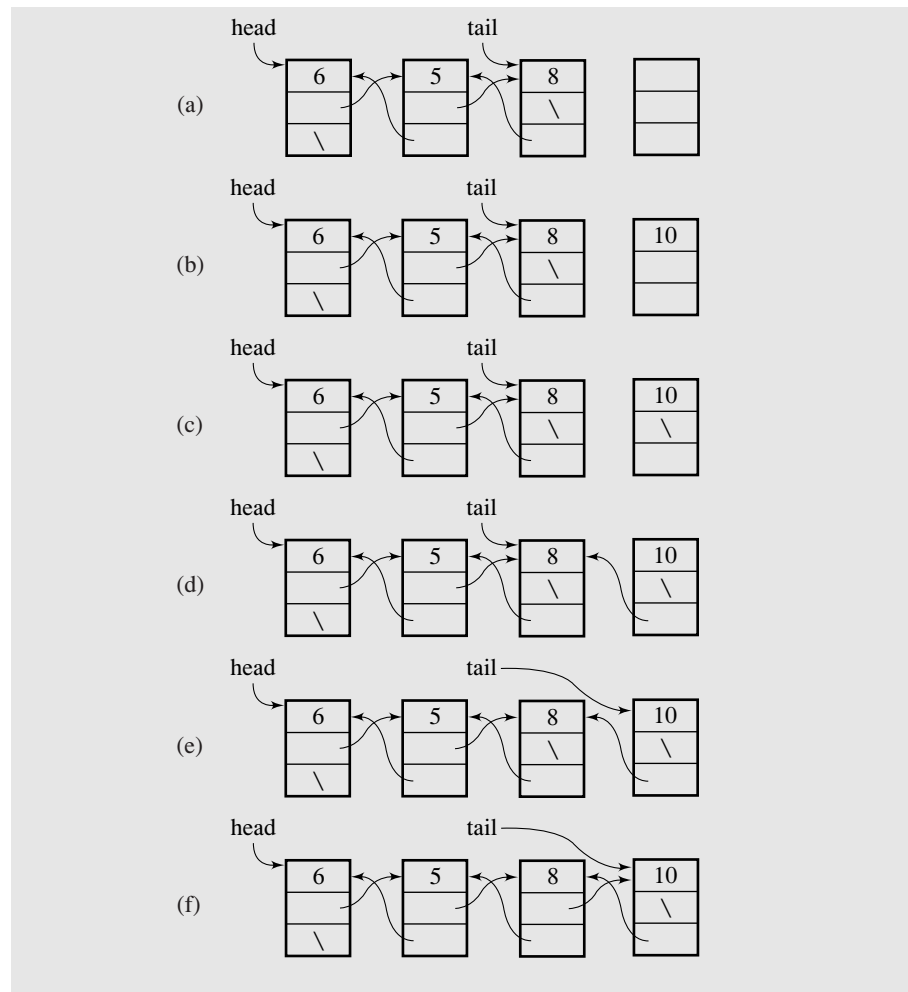
```

Methods for processing doubly linked lists are slightly more complicated than their singly linked counterparts because there is one more reference field to be maintained. Only two methods are discussed: a method to insert a node at the end of a doubly linked list and a method to remove a node from the end (Figure 3.11).

To add a node to a list, the node has to be created, its fields properly initialized, and then the node needs to be incorporated into the list. Inserting a node at the end of a doubly linked list is illustrated in Figure 3.12. The process is performed in six steps:

1. A new node is created (Figure 3.12a), and then its three fields are initialized:
2. the `info` field to the number `e1` being inserted (Figure 3.12b),
3. the `next` field to null (Figure 3.12c),

**FIGURE 3.12** Adding a new node at the end of a doubly linked list.

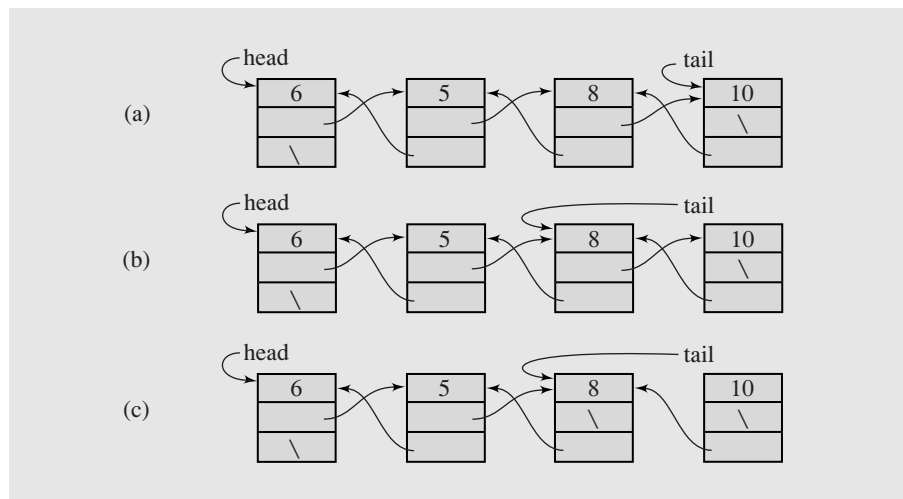


4. and the `prev` field to the value of `tail` so that this field points to the last node in the list (Figure 3.12d). But now, the new node should become the last node; therefore,
5. `tail` is set to reference the new node (Figure 3.12e). But the new node is not yet accessible from its predecessor; to rectify this,
6. the `next` field of the predecessor is set to reference the new node (Figure 3.12f).

A special case concerns the last step. It is assumed in this step that the newly created node has a predecessor, so it accesses its `prev` field. It should be obvious that for an empty linked list, the new node is the only node in the list and it has no predecessor. In this case, both `head` and `tail` refer to this node, and the sixth step is now setting `head` to refer to this node. Note that step four—setting the `prev` field to the value of `tail`—is executed properly because for an initially empty list, `tail` is null. Thus, null becomes the value of the `prev` field of the new node.

Deleting the last node from the doubly linked list is straightforward because there is direct access from the last node to its predecessor, and no loop is needed to remove the last node. When deleting a node from the list in Figure 3.13a, the temporary variable `e1` is set to the value in the last node, then `tail` is set to its predecessor (Figure 3.13b), and the last node is cut off from the list by setting the `next` field of the next to last node to null. In this way, the next to last node becomes the last node, and the formerly last node is abandoned (Figure 3.13c). Although this node accesses the list, the node is inaccessible from the list; hence, it will be claimed by the garbage collector. The last step is returning the value stored in the removed node.

**FIGURE 3.13** Deleting a node from the end of a doubly linked list.



An attempt to delete a node from an empty list may result in a program crash. Therefore, the user has to check whether the list is not empty before attempting to delete the last node. As with the singly linked list's `deleteFromHead()`, the caller should have an `if` statement

```
if (!list.isEmpty())
    n = list.deleteFromTail();
else do not remove;
```

The second special case is the deletion of the only node from a single-node linked list. In this case, both `head` and `tail` are set to null.

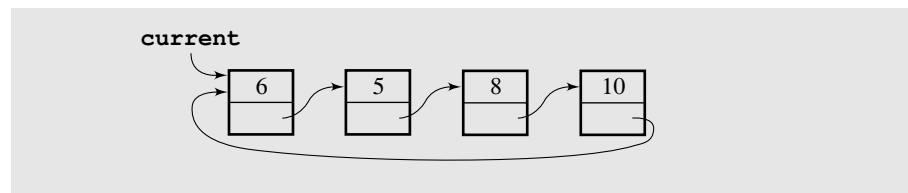
Because of the immediate accessibility of the last node, both `addToTail()` and `deleteFromTail()` execute in constant time  $O(1)$ .

Methods for operating at the beginning of the doubly linked list are easily obtained from the two methods just discussed by changing `head` to `tail` and vice versa, changing `next` to `prev` and vice versa, and exchanging the order of parameters when executing `new`.

### 3.3 CIRCULAR LISTS

In some situations, a *circular list* is needed in which nodes form a ring: The list is finite and each node has a successor. An example of such a situation is when several processes are using the same resource for the same amount of time, and we have to assure that each process has a fair share of the resource. Therefore, all processes—let their numbers be 6, 5, 8, and 10, as in Figure 3.14—are put on a circular list accessible through `current`. After one node in the list is accessed and the process number is retrieved from the node to activate this process, `current` moves to the next node so that the next process can be activated the next time.

**FIGURE 3.14** A circular singly linked list.

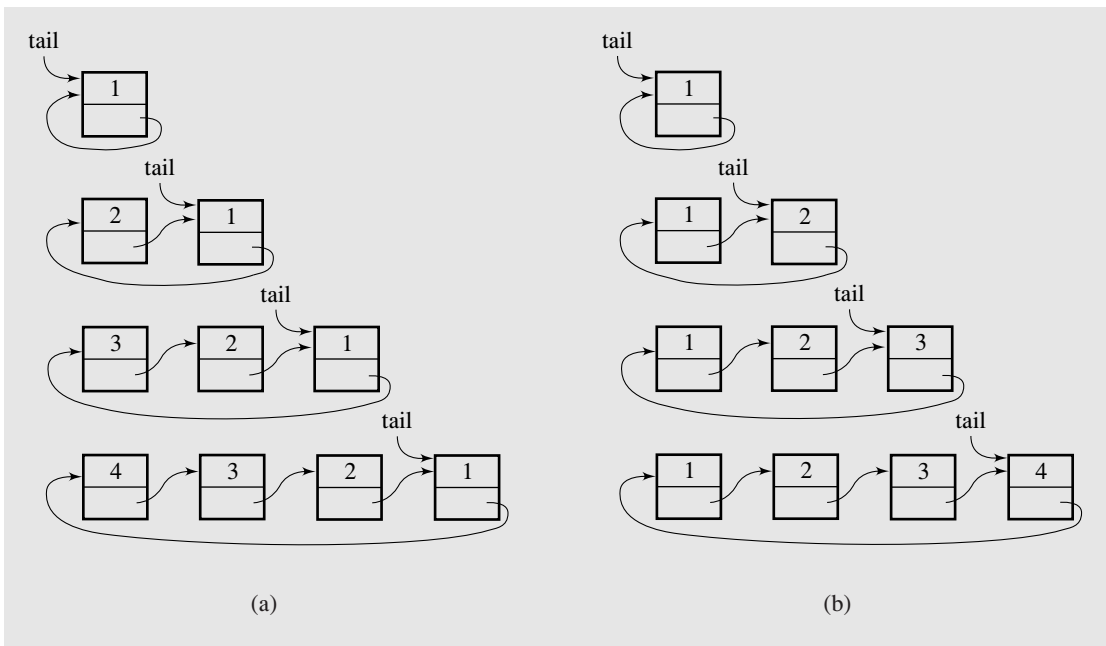


In an implementation of a circular singly linked list, we can use only one permanent reference, `tail`, to the list even though operations on the list require access to the tail and its successor, the head. To that end, a linear singly linked list as discussed in Section 3.1 uses two permanent references, `head` and `tail`.

Figure 3.15a shows a sequence of insertions at the front of the circular list, and Figure 3.15b illustrates insertions at the end of the list. As an example of a method operating on such a list, we present a method to insert a node at the tail of a circular singly linked list:

```
public void addToTail(int el) {
    if (isEmpty()) {
        tail = new IntSLLNode(el);
        tail.next = tail;
    }
    else {
        tail.next = new IntSLLNode(el,tail.next);
        tail = tail.next;
    }
}
```

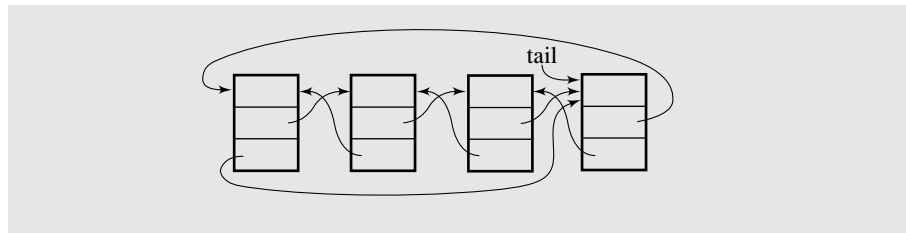
**FIGURE 3.15** Inserting nodes at the front of a circular singly linked list (a) and at its end (b).



The implementation just presented is not without its problems. A method for deletion of the tail node requires a loop so that `tail` can be set to its predecessor after deleting the node. This makes this method delete the tail node in  $O(n)$  time.

Moreover, processing data in the reverse order (printing, searching, etc.) is not very efficient. To avoid the problem and still be able to insert and delete nodes at the front and at the end of the list without using a loop, a doubly linked circular list can be used. The list forms two rings: one going forward through `next` fields and one going backward through `prev` fields. Figure 3.16 illustrates such a list accessible through the last node. Deleting the node from the end of the list can be done easily because there is direct access to the next to last node that needs to be updated in the case of such a deletion. In this list, both insertion and deletion of the tail node can be done in  $O(1)$  time.

**FIGURE 3.16** A circular doubly linked list.

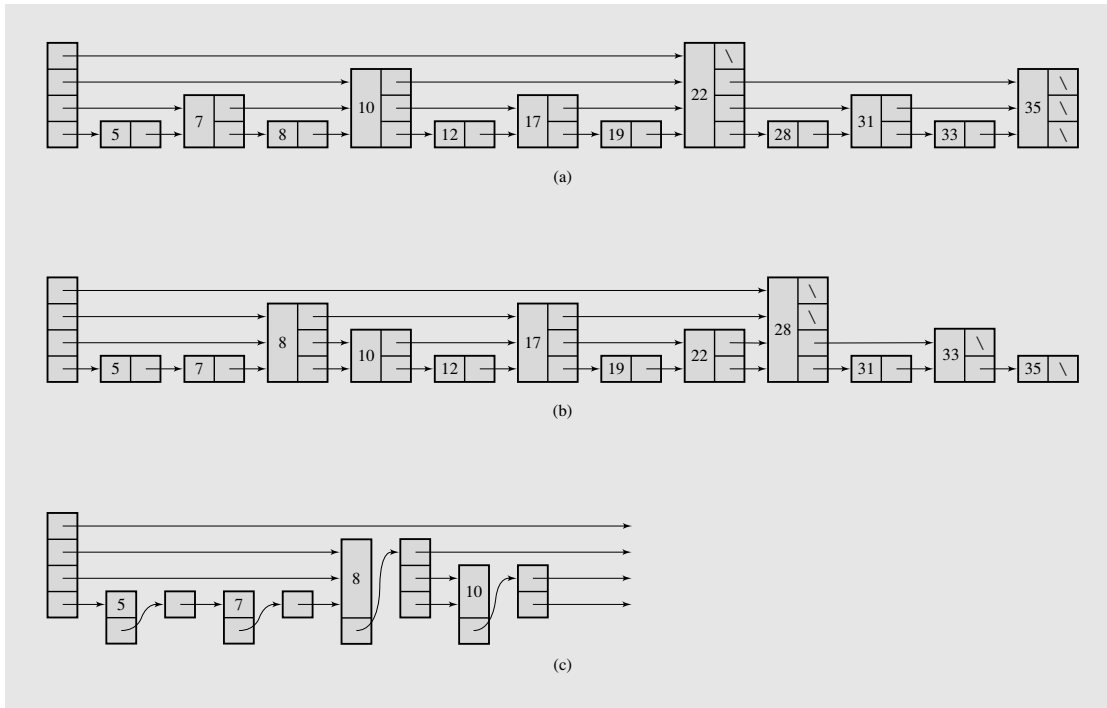


## 3.4 SKIP LISTS

Linked lists have one serious drawback: They require sequential scanning to locate a searched-for element. The search starts from the beginning of the list and stops when either a searched-for element is found or the end of the list is reached without finding this element. Ordering elements on the list can speed up searching, but a sequential search is still required. Therefore, we may think about lists that allow for skipping certain nodes to avoid sequential processing. A *skip list* is an interesting variant of the ordered linked list that makes such a nonsequential search possible (Pugh 1990).

In a skip list of  $n$  nodes, for each  $k$  and  $i$  such that  $1 \leq k \leq \lfloor \lg n \rfloor$  and  $1 \leq i \leq \lfloor n/2^{k-1} \rfloor - 1$ , the node in position  $2^{k-1} \cdot i$  points to the node in position  $2^{k-1} \cdot (i + 1)$ . This means that every second node points to the node two positions ahead, every fourth node points to the node four positions ahead, and so on, as shown in Figure 3.17a. This is accomplished by having different numbers of reference fields in nodes on the list: Half of the nodes have just one reference field, one-fourth of the nodes have two reference fields, one-eighth of the nodes have three reference fields, and so on. The number of reference fields indicates the *level* of each node, and the number of levels is  $maxLevel = \lfloor \lg n \rfloor + 1$ .

**FIGURE 3.17** A skip list with (a) evenly and (b) unevenly spaced nodes of different levels; (c) the skip list with reference nodes clearly shown.



Searching for an element  $e_1$  consists of following the references on the highest level until an element is found that finishes the search successfully. In the case of reaching the end of the list or encountering an element  $key$  that is greater than  $e_1$ , the search is restarted from the node preceding the one containing  $key$ , but this time starting from a reference on a lower level than before. The search continues until  $e_1$  is found, or the first-level references are followed to reach the end of the list or to find an element greater than  $e_1$ . Here is a pseudocode for this algorithm:

```

find(element e1)
  p = the nonnull list on the highest level i;
  while e1 not found and i ≥ 0
    if p.key < e1
      p = a sublist that begins in the predecessor of p on level --i;
    else if p.key > e1
      if p is the last node on level i
        p = a nonnull sublist that begins in p on the highest level < i;
        i = the number of the new level;
      else p = p.next;

```



For example, if we look for number 16 in the list in Figure 3.17b, then level four is tried first, which is unsuccessful because the first node on this level has 28. Next, we try the third-level sublist starting from the root: It first leads to 8 and then to 17. Hence, we try the second-level sublist that originates in the node holding 8: It leads to 10 and then again to 17. The last try is by starting the first-level sublist, which begins in node 10; this sublist's first node has 12, the next number is 17, and because there is no lower level, the search is pronounced unsuccessful. The path through which the list passed during this searching process is indicated in Figure 3.17c with a dashed line. Code for the searching method is given in Figure 3.18.

**FIGURE 3.18** An implementation of a skip list.

```

/***** IntSkipListNode.java *****/

public class IntSkipListNode {
    public int key;
    public IntSkipListNode[] next;
    IntSkipListNode(int i, int n) {
        key = i;
        next = new IntSkipListNode[n];
        for (int j = 0; j < n; j++)
            next[j] = null;
    }
}

/***** IntSkipList.java *****/

import java.util.Random;

public class IntSkipList {
    private int maxLevel;
    private IntSkipListNode[] root;
    private int[] powers;
    private Random rd = new Random();
    IntSkipList() {
        this(4);
    }
    IntSkipList (int i) {
        maxLevel = i;
        root = new IntSkipListNode[maxLevel];
        powers = new int[maxLevel];
        for (int j = 0; j < maxLevel; j++)
            root[j] = null;
        choosePowers();
    }
}

```

*Continues*

**FIGURE 3.18** (continued)

```

public boolean isEmpty() {
    return root[0] == null;
}
public void choosePowers() {
    powers[maxLevel-1] = (2 << (maxLevel-1)) - 1;    // 2^maxLevel - 1
    for (int i = maxLevel - 2, j = 0; i >= 0; i--, j++)
        powers[i] = powers[i+1] - (2 << j);        // 2^(j+1)
}
public int chooseLevel() {
    int i, r = Math.abs(rd.nextInt()) % powers[maxLevel-1] + 1;
    for (i = 1; i < maxLevel; i++)
        if (r < powers[i])
            return i-1; // return a level < the highest level;
    return i-1;        // return the highest level;
}
// make sure (with isEmpty()) that skipListSearch() is called for a
// nonempty list;
public int skipListSearch (int key) {
    int lvl;
    IntSkipListNode prev, curr;        // find the highest non-null
    for (lvl = maxLevel-1; lvl >= 0 && root[lvl] == null; lvl--); // level;
    prev = curr = root[lvl];
    while (true) {
        if (key == curr.key)            // success if equal;
            return curr.key;
        else if (key < curr.key) {      // if smaller, go down,
            if (lvl == 0)                // if possible,
                return 0;
            else if (curr == root[lvl]) // by one level
                curr = root[--lvl];     // starting from the
            else curr = prev.next[--lvl]; // predecessor which
        }                               // can be the root;
        else {                           // if greater,
            prev = curr;                 // go to the next
            if (curr.next[lvl] != null) // non-null node
                curr = curr.next[lvl];  // on the same level
            else {                       // or to a list on a lower level;
                for (lvl--; lvl >= 0 && curr.next[lvl] == null; lvl--);
                if (lvl >= 0)
                    curr = curr.next[lvl];
                else return 0;
            }
        }
    }
}
}
}

```

**FIGURE 3.18** (continued)

```

public void skipListInsert (int key) {
    IntSkipListNode[] curr = new IntSkipListNode[maxLevel];
    IntSkipListNode[] prev = new IntSkipListNode[maxLevel];
    IntSkipListNode newNode;
    int lvl, i;
    curr[maxLevel-1] = root[maxLevel-1];
    prev[maxLevel-1] = null;
    for (lvl = maxLevel - 1; lvl >= 0; lvl--) {
        while (curr[lvl] != null && curr[lvl].key < key) { // go to the next
            prev[lvl] = curr[lvl];           // if smaller;
            curr[lvl] = curr[lvl].next[lvl];
        }
        if (curr[lvl] != null && curr[lvl].key == key) // don't include
            return; // duplicates;
        if (lvl > 0) // go one level down
            if (prev[lvl] == null) { // if not the lowest
                curr[lvl-1] = root[lvl-1]; // level, using a link
                prev[lvl-1] = null; // either from the root
            }
            else { // or from the predecessor;
                curr[lvl-1] = prev[lvl].next[lvl-1];
                prev[lvl-1] = prev[lvl];
            }
        }
    }
    lvl = chooseLevel(); // generate randomly level
                        // for newNode;
    newNode = new IntSkipListNode(key, lvl+1);
    for (i = 0; i <= lvl; i++) { // initialize next fields of
        newNode.next[i] = curr[i]; // newNode and reset to newNode
        if (prev[i] == null) // either fields of the root
            root[i] = newNode; // or next fields of newNode's
        else prev[i].next[i] = newNode; // predecessors;
    }
}
}

```

Searching appears to be efficient; however, the design of skip lists can lead to very inefficient insertion and deletion procedures. To insert a new element, all nodes following the node just inserted have to be restructured; the number of reference fields and the value of references have to be changed. In order to retain some of the advantages that skip lists offer with respect to searching and to avoid problems with restructuring the lists when inserting and deleting nodes, the requirement on the positions of nodes of different levels is now abandoned and only

the requirement on the number of nodes of different levels is kept. For example, the list in Figure 3.17a becomes the list in Figure 3.17b: Both lists have six nodes in level one (with one reference field), three nodes in level two, two nodes in level three, and one node in level four. The new list is searched exactly the same way as the original list. Inserting does not require list restructuring, and nodes are generated so that the distribution of the nodes on different levels is kept adequate. How can this be accomplished?

Assume that  $maxLevel = 4$ . For 15 elements, the required number of nodes on level one is eight, on level two is four, on level three is two, and in level one is one. Each time a node is inserted, a random number  $r$  between 1 and 15 is generated, and if  $r < 9$ , then a node of level one is inserted. If  $r < 13$ , a second-level node is inserted, if  $r < 15$ , it is a third-level node, and if  $r = 15$ , the node of level four is generated and inserted. If  $maxLevel = 5$ , then for 31 elements the correspondence between the value of  $r$  and the level of node is as follows:

$r$	Level of Node to Be Inserted
31	5
29–30	4
25–28	3
17–24	2
1–16	1

To determine such a correspondence between  $r$  and the level of node for any  $maxLevel$ , the method `choosePowers()` initializes the array `powers[]` by putting lower bounds on each range. For example, for  $maxLevel = 4$ , the array is [1 9 13 15]; for  $maxLevel = 5$ , it is [1 17 25 29 31]. `chooseLevel()` uses `powers[]` to determine the level of the node about to be inserted. Figure 3.18 contains the code for `choosePowers()` and `chooseLevel()`. Note that the levels range between 0 and  $maxLevel - 1$  (and not between 1 and  $maxLevel$ ) so that the array indexes can be used as levels. For example, the first level is level zero.

But we also have to address the question of implementing a node. The easiest way is to make each node have  $maxLevel$  reference fields, but this is wasteful. We need only as many reference fields per node as the level of the node requires. To accomplish this, the `next` field of each node is not a reference to the next node, but to an array of reference(s) to the next node(s). The size of this array is determined by the level of the node. The `IntSkipListNode` and `SkipList` classes are declared as in Figure 3.18. In this way, the list in Figure 3.17b is really a list whose first four nodes are shown in Figure 3.17c. Only now can an inserting procedure be implemented, as in Figure 3.18.

How efficient are skip lists? In the ideal situation, which is exemplified by the list in Figure 3.17a, the search time is  $O(\lg n)$ . In the worst situation, when all lists are on the same level, the skip list turns into a regular singly linked list, and the search time is  $O(n)$ . However, the latter situation is unlikely to occur; in the random skip list, the search time is of the same order as the best case; that is,  $O(\lg n)$ . This is an improvement over the efficiency of searching regular linked lists. It also turns out that skip lists fare extremely well in comparison with more sophisticated data

structures, such as self-adjusting trees or AVL trees (see Sections 6.7.2 and 6.8), and therefore they are a viable alternative to these data structures (see also the table in Figure 3.21).

## 3.5

## SELF-ORGANIZING LISTS

The introduction of skip lists was motivated by the need to speed up the searching process. Although singly and doubly linked lists require sequential search to locate an element or to see that it is not in the list, we can improve the efficiency of the search by dynamically organizing the list in a certain manner. This organization depends on the configuration of data; thus, the stream of data requires reorganizing the nodes already on the list. There are many different ways to organize the lists, and this section describes four of them:

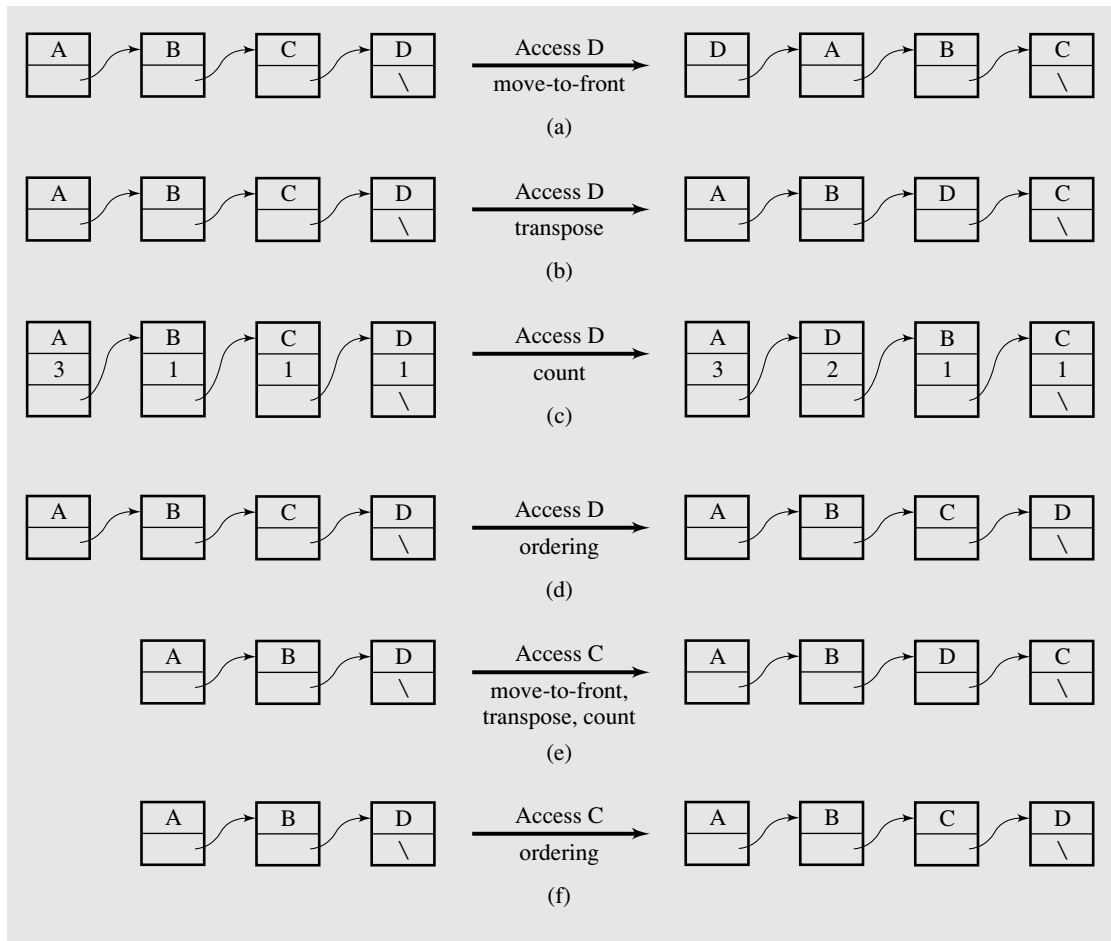
1. *Move-to-front method.* After the desired element is located, put it at the beginning of the list (Figure 3.19a).
2. *Transpose method.* After the desired element is located, swap it with its predecessor unless it is at the head of the list (Figure 3.19b).
3. *Count method.* Order the list by the number of times elements are being accessed (Figure 3.19c).
4. *Ordering method.* Order the list using certain criteria natural for the information under scrutiny (Figure 3.19d).

In the first three methods, new information is stored in a node added to the end of the list (Figure 3.19e); in the fourth method, new information is stored in a node inserted somewhere in the list to maintain the order of the list (Figure 3.19f). An example of searching for elements in a list organized by these different methods is shown in Figure 3.20.

With the first three methods, we try to locate the elements most likely to be looked for near the beginning of the list, most explicitly with the move-to-front method and most cautiously with the transpose method. The ordering method already uses some properties inherent to the information stored in the list. For example, if we are storing nodes pertaining to people, then the list can be organized alphabetically by the name of the person or the city or in ascending or descending order using, say, birthday or salary. This is particularly advantageous when searching for information that is not in the list, because the search can terminate without scanning the entire list. Searching all the nodes of the list, however, is necessary in such cases using the other three methods. The count method can be subsumed in the category of the ordering methods if frequency is part of the information. In many cases, however, the count itself is an additional piece of information required solely to maintain the list; hence, it may not be considered “natural” to the information at hand.

Analyses of the efficiency of these methods customarily compare their efficiency to that of *optimal static ordering*. With this ordering, all the data are already ordered by the frequency of their occurrence in the body of data so that the list is used only for searching, not for inserting new items. Therefore, this approach requires two passes through the body of data, one to build the list and another to use the list for search alone.

**FIGURE 3.19** Accessing an element on a linked list and changes on the list depending on the self-organization technique applied: (a) move-to-front method, (b) transpose method, (c) count method, and (d) ordering method, in particular, alphabetical ordering, which leads to no change. In the case when the desired element is not in the list, (e) the first three methods add a new node with this element at the end of the list and (f) the ordering method maintains an order on the list.



To experimentally measure the efficiency of these methods, the number of all actual comparisons was compared to the maximum number of possible comparisons. The latter number is calculated by adding the lengths of the list at the moment of processing each element. For example, in the table in Figure 3.20, the body of data contains 14 letters, 5 of them being different, which means that 14 letters were processed. The length of the list before processing each letter is recorded, and the result,  $0 + 1 + 2 + 3 + 3 + 4 + 4 + 4 + 4 + 4 + 4 + 4 + 4 + 4 + 5 = 46$ , is used to compare the number of all compar-

**FIGURE 3.20** Processing the stream of data, A C B C D A D A C A C C E E, by different methods of organizing linked lists. Linked lists are presented in an abbreviated form; for example, the transformation shown in Figure 3.19a is abbreviated as transforming list A B C D into list D A B C.

Element Searched For	Plain	Move-to-Front	Transpose	Count	Ordering
A:	A	A	A	A	A
C:	A C	A C	A C	A C	A C
B:	A C B	A C B	A C B	A C B	A B C
C:	A C B	C A B	C A B	C A B	A B C
D:	A C B D	C A B D	C A B D	C A B D	A B C D
A:	A C B D	A C B D	A C B D	C A B D	A B C D
D:	A C B D	D A C B	A C D B	D C A B	A B C D
A:	A C B D	A D C B	A C D B	A D C B	A B C D
C:	A C B D	C A D B	C A D B	C A D B	A B C D
A:	A C B D	A C D B	A C D B	A C D B	A B C D
C:	A C B D	C A D B	C A D B	A C D B	A B C D
C:	A C B D	C A D B	C A D B	C A D B	A B C D
E:	A C B D E	C A D B E	C A D B E	C A D B E	A B C D E
E:	A C B D E	E C A D B	C A D E B	C A E D B	A B C D E

isons made to this combined length. In this way, we know what percentage of the list was scanned during the entire process. For all the list organizing methods except optimal ordering, this combined length is the same; only the number of comparisons can change. For example, when using the move-to-front technique for the data in the table in Figure 3.20, 33 comparisons were made, which is 71.7% when compared to 46. The latter number gives the worst possible case, the combined length of intermediate lists every time all the nodes in the list are looked at. Plain search, with no reorganization, required only 30 comparisons, which is 65.2%.

These samples are in agreement with theoretical analyses that indicate that count and move-to-front methods are, in the long run, at most twice as costly as the optimal static ordering; the transpose method approaches, in the long run, the cost of the move-to-front method. In particular, with amortized analysis, it can be established that the cost of accessing a list element with the move-to-front method is at most twice the cost of accessing this element on the list that uses optimal static ordering.

In a proof of this statement, the concept of inversion is used. For two lists containing the same elements, an inversion is defined to be a pair of elements  $(x, y)$  such that on one list  $x$  precedes  $y$  and on the other list  $y$  precedes  $x$ . For example, the list

$(C, B, D, A)$  has four inversions with respect to list  $(A, B, C, D)$ :  $(C, A)$ ,  $(B, A)$ ,  $(D, A)$ , and  $(C, B)$ . Define the amortized cost to be the sum of actual cost and the difference between the number of inversions before accessing an element and after accessing it,

$$amCost(x) = cost(x) + (inversionsBeforeAccess(x) - inversionsAfterAccess(x))$$

To assess this number, consider an optimal list  $OL = (A, B, C, D)$  and a move-to-front list  $MTF = (C, B, D, A)$ . The access of elements usually changes the balance of inversions. Let  $displaced(x)$  be the number of elements preceding  $x$  in MTF but following  $x$  in  $OL$ . For example,  $displaced(A) = 3$ ,  $displaced(B) = 1$ ,  $displaced(C) = 0$ , and  $displaced(D) = 0$ . If  $pos_{MTF}(x)$  is the current position of  $x$  in MTF, then  $pos_{MTF}(x) - 1 - displaced(x)$  is the number of elements preceding  $x$  in both lists. It is easy to see that for  $D$  this number equals 2, and for the remaining elements it is 0. Now, accessing an element  $x$  and moving it to the front of MTF creates  $pos_{MTF}(x) - 1 - displaced(x)$  new inversions and removes  $displaced(x)$  other inversions so that the amortized time to access  $x$  is

$$amCost(x) = pos_{MTF}(x) + pos_{MTF}(x) - 1 - displaced(x) - displaced(x) = 2(pos_{MTF}(x) - displaced(x)) - 1$$

where  $cost(x) = pos_{MTF}(x)$ . Accessing  $A$  transforms  $MTF = (C, B, D, A)$  into  $(A, C, B, D)$  and  $amCost(A) = 2(4 - 3) - 1 = 1$ . For  $B$ , the new list is  $(B, C, D, A)$  and  $amCost(B) = 2(2 - 1) - 1 = 1$ . For  $C$ , the list does not change and  $amCost(C) = 2(1 - 0) - 1 = 1$ . Finally, for  $D$ , the new list is  $(D, C, B, A)$  and  $amCost(D) = 2(3 - 0) - 1 = 5$ . However, the number of common elements preceding  $x$  on the two lists cannot exceed the number of all the elements preceding  $x$  on  $OL$ ; therefore,  $pos_{MTF}(x) - 1 - displaced(x) \leq pos_{OL}(x) - 1$ , so that

$$amCost(x) \leq 2pos_{OL}(x) - 1$$

The amortized cost of accessing an element  $x$  in MTF is in excess of  $pos_{OL}(x) - 1$  units to its actual cost of access on  $OL$ . This excess is used to cover an additional cost of accessing elements in MTF for which  $pos_{MTF}(x) > pos_{OL}(x)$ ; that is, elements that require more accesses on MTF than on  $OL$ .

It is important to stress that the amortized costs of single operations are meaningful in the context of sequences of operations. A cost of an isolated operation may seldom equal its amortized cost; however, in a sufficiently long sequence of accesses, each access on the average takes at most  $2pos_{OL}(x) - 1$  time.

Figure 3.21 contains sample runs of the self-organizing lists. The second and the fourth columns of numbers refer to files containing programs, and the remaining columns refer to files containing English text. There is a general tendency for all methods to improve their efficiency with the size of the file. The move-to-front and count methods are almost the same in their efficiency, and both outperform the transpose, plain, and ordering methods. The poor performance for smaller files is due to the fact that all of the methods are busy including new words in the lists, which requires an exhaustive search of the lists. Later, the methods concentrate on organizing the lists to reduce the number of searches. The table in Figure 3.21 also includes data for a skip list. There is an overwhelming difference between the skip list's efficiency compared to the other methods. However, keep in mind that in the table in Figure 3.21, only comparisons of data are included, with no indication of the other operations needed for execution of the analyzed methods. In particular, there is no indication of how many references are used and relinked, which, when included, may make the difference between various methods less dramatic.



**FIGURE 3.21** Measuring the efficiency of different methods using formula (number of data comparisons)/(combined length) expressed in percentages.

Different Words/ All Words	156/347	149/423	609/1510	550/2847	1163/5866	2013/23065
Optimal	28.5	26.4	24.5	17.6	16.2	10.0
Plain	70.3	71.2	67.1	56.3	51.7	35.4
Move-to-Front	61.3	49.5	54.5	31.3	30.5	18.4
Transpose	68.8	69.5	66.1	53.3	49.4	32.9
Count	61.2	51.6	54.7	34.0	32.0	19.8
Alphabetical Order	50.9	45.6	48.0	55.7	50.4	50.0
Skip List	15.1	12.3	6.6	5.5	4.8	3.8

These sample runs show that for lists of modest size, the linked list suffices. With the increase in the amount of data and in the frequency with which they have to be accessed, more sophisticated methods and data structures need to be used.

## 3.6 SPARSE TABLES

In many applications, the choice of a table seems to be the most natural one, but space considerations may preclude this choice. This is particularly true if only a small fraction of the table is actually used. A table of this type is called a *sparse table* because the table is populated sparsely by data and most of its cells are empty. In this case, the table can be replaced by a system of linked lists.

As an example, consider the problem of storing grades for all students in a university for a certain semester. Assume that there are 8,000 students and 300 classes. A natural implementation is a two-dimensional array `grades` where student numbers are indexes of the columns and class numbers are indexes of the rows (see Figure 3.22). An association of student names and numbers is represented by the one-dimensional array `students` and an association of class names and numbers by the array `classes`. The names do not have to be ordered. If order is required, then another array can be used where each array element is occupied by an object with two fields, name and number,<sup>1</sup> or the original array can be sorted each time an order is required. This, however, leads to the constant reorganization of `grades`, and is not recommended.

Each cell of `grades` stores a grade obtained by each student after finishing a class. If signed grades such as A-, B+, or C+ are used, then two characters (that is, four bytes) are required to store each grade. To reduce the table size by one-half, the array `grade-codes` in Figure 3.22c associates each grade with a codeword that requires only one byte of storage.

<sup>1</sup>This is called an *index-inverted table*.

**FIGURE 3.22** Arrays and sparse table used for storing student grades.

(a) students

0	Sheaver Geo
1	Weaver Henry
2	Shelton Mary
:	
404	Crawford William
405	Lawson Earl
:	
5206	Fulton Jenny
5207	Craft Donald
5208	Oates Key
:	

(b) classes

0	Anatomy/Physiology
1	Introduction to Microbiology
:	
30	Advanced Writing
31	Chaucer
:	
115	Data Structures
116	Cryptology
117	Computer Ethics
:	

(c) gradeCodes

0	A
1	A-
2	B+
3	B
4	B-
5	C+
6	C
7	C-
8	D
9	F

(d) grades

class	student											
	0	1	2	...	404	405	...	5206	5207	5208	...	7999
0										3		
1	1		4		7			1				
:												
30		5								3		
31	0					5						
:												
115			0		4				5			
116			3									
117												
:												
299												

The entire table (Figure 3.22d) occupies  $8,000 \text{ students} \cdot 300 \text{ classes} \cdot 1 \text{ byte} = 2.4$  million bytes. This table is very large but is sparsely populated by grades. Assuming that, on the average, students take four classes a semester, each column of the table has only four cells occupied by grades, and the rest of the cells, 296 cells or 98.7%, are unoccupied and wasted.

A better solution is to use two pairs of parallel two-dimensional arrays: In one, `classesTaken1` and `classesTaken2` represent all the classes taken by every student; in the other, `studentsInClasses1` and `studentsInClasses2` represent all students participating in each class (Figure 3.23). Moreover, `classesTaken1` contains class numbers, `studentsInClasses1` contains student numbers, and

**FIGURE 3.23** Two-dimensional arrays for storing student grades.

		classesTaken1										
		0	1	2	...	404	405	...	5206	5207	5208	... 7999
0		1	30	1		1	31		1	115	0	
1		31		115		115	64		33	121	30	
2		124		116		218	120		86	146	208	
3		136				221			121	156	211	
4						285			203		234	
5						292						
6												
7												

		classesTaken2										
		0	1	2	...	404	405	...	5206	5207	5208	... 7999
0		1	5	4		7	5		1	5	3	
1		0		0		4	5		1	5	3	
2		0		3		6	4		0	3	2	
3		2				5			2	0	3	
4						3			2		1	
5						3						
6												
7												

(a)

		studentsInClass1								
		0	1	...	30	31	...	115	116	... 299
0		5208	0		1	0		2	2	
1			2		5208	405		404		
2			404					5207		
3			5206							
...										
249										

		studentsInClass2								
		0	1	...	30	31	...	115	116	... 299
0		3	0		5	0		0	3	
1			0		3	5		4		
2			7					5		
3			1							
...										
249										

(b)

`classesTaken2` and `studentsInClasses2` contain grades. We assume that a student can take at most 8 classes and that there can be at most 250 students signed up for a class. We need two pairs of arrays, because with one array only it is very time-consuming to produce lists. For example, if only `classesTaken1` and `classesTaken2` were used, then printing a list of all students taking a particular class would very much require an exhaustive search of these two arrays.

Assume that short integers are used to store student and class numbers, which occupy 2 bytes to store an integer. With this new structure, 3 bytes are needed for each cell. Therefore, the tables `classesTaken1` and `classesTaken2` occupy  $8,000 \text{ students} \cdot 8 \text{ classes} \cdot 3 \text{ bytes} = 192,000 \text{ bytes}$ , and tables `studentsInClasses1` and `studentsInClasses2` occupy  $300 \text{ classes} \cdot 250 \text{ students} \cdot 3 \text{ bytes} = 225,000 \text{ bytes}$ , and all the tables require a total of 417,000 bytes, less than one-fifth the number of bytes required for the sparse table in Figure 3.22.

Although this is a much better implementation than before, it still suffers from a wasteful use of space; seldom, if ever, will both arrays be full because most classes have fewer than 250 students, and most students take fewer than 8 classes. This structure is also inflexible: If a class can be taken by more than 250 students, a problem occurs that has to be circumvented in an artificial way. One way is to create a nonexistent class that holds students from the overflowing class. Another way is to recompile the program with a new table size, which may not be practical at a future time. Another more flexible solution is needed.

Two one-dimensional arrays of linked lists can be used as in Figure 3.24. Each cell of the array `class` is a reference to a linked list of students taking a class, and each cell of the array `student` indicates a linked list of classes taken by a student. The linked lists contain nodes of five fields: student number, class number, grade, a reference to the next student, and a reference to the next class. Assuming that each reference requires only 4 bytes and one node occupies 13 bytes, the entire structure can be stored in  $8,000 \text{ students} \cdot 4 \text{ classes (on the average)} \cdot 13 \text{ bytes} = 416,000 \text{ bytes}$ , which is approximately 17% of the space required for the first implementation and roughly the same amount of space of the second. But now, no space is used unnecessarily, there is no restriction imposed on the number of students per class, and the lists of students taking a class can be printed immediately, even faster than in the first approach.

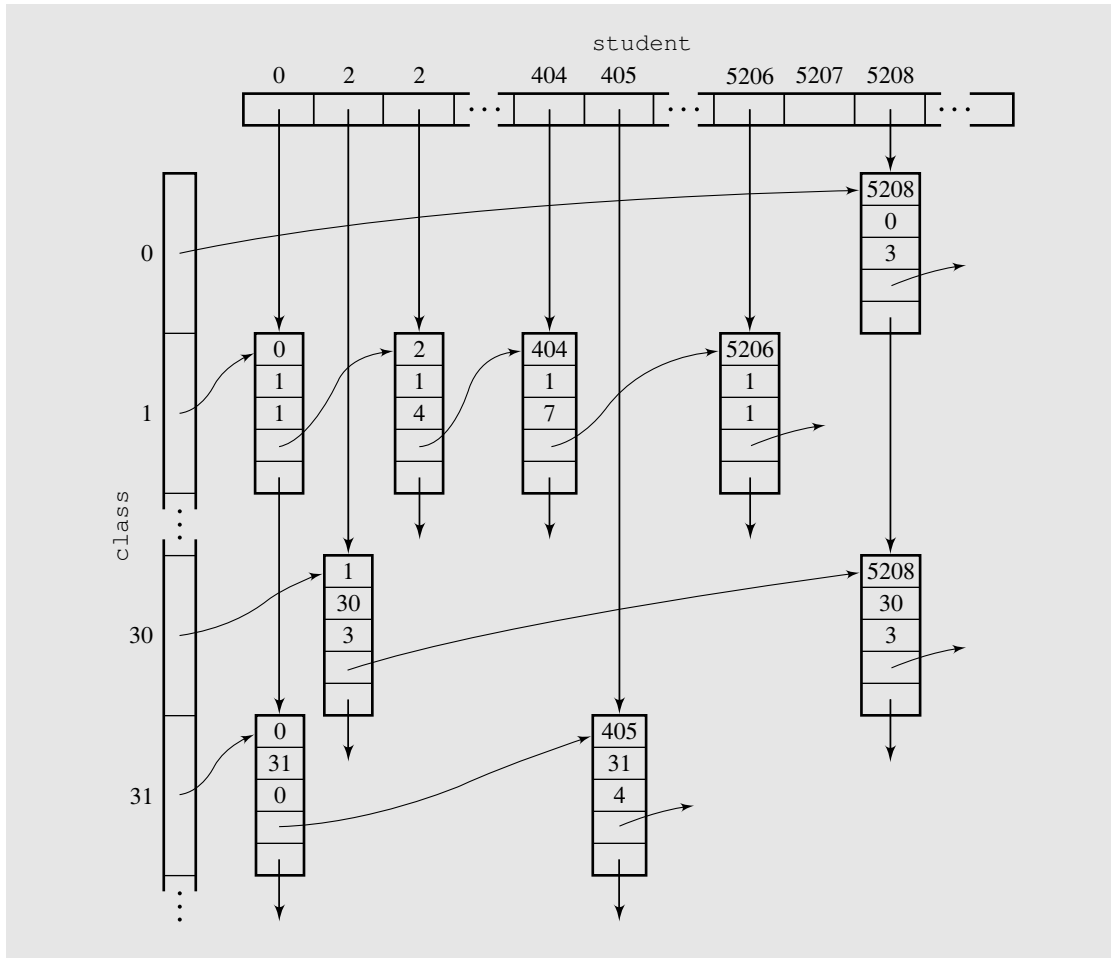
## 3.7 LISTS IN `java.util`

### 3.7.1 `LinkedList`

The `LinkedList` class in the `java.util` package is an implementation of various operations on the nodes of a linked list. The `LinkedList` class implements a list as a generic doubly linked list with references to the head and to the tail. An instance of such a list that stores integers is presented in Figure 3.10.

The class hierarchy in the package `java.util` is as follows:

```
Object ⇒ AbstractCollection ⇒ AbstractList
      ⇒ AbstractSequentialList ⇒ LinkedList
```

**FIGURE 3.24** Student grades implemented using linked lists.

The methods included in the `LinkedList` class are represented in Figure 3.25, but the methods `finalize()`, `getClass()`, `notify()`, `notifyAll()`, and `wait()` inherited from class `Object` are not included.

The workings of most of the methods have already been illustrated in the case of the class `Vector` (Figure 1.4 and the discussion of these methods in Section 1.5). A demonstration of some of the linked list methods is presented in Figure 3.26.

New elements can be added at the beginning of the list with `addFirst()`, at the end of the list with `addLast()`, and anywhere inside the list with `add()`. Elements can be retrieved from the list, without removing them from it, with `getFirst()`, `getLast()`, and `get()`. Elements can also be removed permanently from the list with several removal methods. An important issue is, however, to perform user-defined operations on individual elements of the list. For example, list elements can be printed with the method

**FIGURE 3.25** An alphabetical list of methods in the class `LinkedList` including some inherited methods.

Method	Operation
<code>boolean add(Object ob)</code>	Insert object <code>ob</code> at the end of the linked list.
<code>void add(int pos, Object ob)</code>	Insert object <code>ob</code> at position <code>pos</code> after shifting elements at positions following <code>pos</code> by one position; throw <code>IndexOutOfBoundsException</code> if <code>pos</code> is out of range.
<code>boolean addAll(Collection c)</code>	Add all the elements from the collection <code>c</code> to the end of the linked list; return <code>true</code> if the linked list was modified; throw <code>NullPointerException</code> if <code>c</code> is null.
<code>boolean addAll(int pos, Collection)</code>	Add all the elements from the collection <code>c</code> at the position <code>pos</code> of the linked list after shifting the objects following position <code>pos</code> ; throw <code>IndexOutOfBoundsException</code> if <code>pos</code> is out of range, and <code>NullPointerException</code> if <code>c</code> is null.
<code>void addFirst(Object ob)</code>	Insert object <code>ob</code> at the beginning of the linked list.
<code>void addLast(Object ob)</code>	Insert object <code>ob</code> at the end of the linked list; same as <code>add(ob)</code> .
<code>void clear()</code>	Remove all the objects from the linked list.
<code>Object clone()</code>	Return the copy of the linked list without cloning its elements.
<code>boolean contains(Object ob)</code>	Return <code>true</code> if the linked list contains the object <code>ob</code> .
<code>boolean containsAll(Collection c)</code>	Return <code>true</code> if the linked list contains all of the objects in the collection <code>c</code> ; throw <code>NullPointerException</code> if <code>c</code> is null (inherited).
<code>boolean equals(Object ob)</code>	Return <code>true</code> if the current linked list and object <code>ob</code> are equal (inherited).
<code>Object get(int pos)</code>	Return the object at position <code>pos</code> ; throw <code>IndexOutOfBoundsException</code> if <code>pos</code> is out of range.
<code>Object getFirst()</code>	Return the first object in the linked list; throw <code>NoSuchElementException</code> if the linked list is empty.
<code>Object getLast()</code>	Return the first object in the linked list; throw <code>NoSuchElementException</code> if the linked list is empty.
<code>int hashCode()</code>	Return the hash code for the linked list (inherited).
<code>int indexOf(Object ob)</code>	Return the position of the first occurrence of object <code>ob</code> in the linked list; return <code>-1</code> if <code>ob</code> is not found.
<code>boolean isEmpty()</code>	Return <code>true</code> if the linked list contains no elements, <code>false</code> otherwise (inherited).
<code>Iterator iterator()</code>	Generate and return an iterator for the linked list (inherited).

**FIGURE 3.25** (continued)

<code>int lastIndexOf(Object ob)</code>	Return the position of the last occurrence of object <code>ob</code> in the linked list; return <code>-1</code> if <code>ob</code> is not found.
<code>LinkedList()</code>	Create an empty linked list.
<code>LinkedList(Collection c)</code>	Create a linked list with copies of elements from collection <code>c</code> ; throw <code>NullPointerException</code> if <code>c</code> is null.
<code>ListIterator listIterator()</code>	Generate and return a list iterator for the linked list initialized to position <code>0</code> (inherited).
<code>ListIterator listIterator(int n)</code>	Generate and return a list iterator for the linked list initialized to position <code>n</code> ; throw <code>IndexOutOfBoundsException</code> if <code>n</code> is out of range.
<code>boolean remove(Object ob)</code>	Remove the first occurrence of <code>ob</code> in the linked list and return <code>true</code> if <code>ob</code> was in the linked list.
<code>Object remove(int pos)</code>	Remove the object at position <code>pos</code> ; throw <code>IndexOutOfBoundsException</code> if <code>pos</code> is out of range.
<code>boolean removeAll(Collection c)</code>	Remove from the linked list all the objects contained in collection <code>c</code> ; return <code>true</code> if any element was removed; throw <code>NullPointerException</code> if <code>c</code> is null (inherited).
<code>Object removeFirst()</code>	Remove and return the first object on the linked list; throw <code>NoSuchElementException</code> if the linked list is empty.
<code>Object removeLast()</code>	Remove and return the last object on the linked list; throw <code>NoSuchElementException</code> if the linked list is empty.
<code>void removeRange(int first, int last)</code>	Remove from the linked list all the objects from position <code>first</code> to position <code>last-1</code> (inherited).
<code>boolean retainAll(Collection c)</code>	Remove from the linked list all objects that are not in the collection <code>c</code> ; return <code>true</code> if any object was removed; throw <code>NullPointerException</code> if <code>c</code> is null (inherited).
<code>Object set(int pos, Object ob)</code>	Assign object <code>ob</code> to position <code>pos</code> and return the object that occupied this position before the assignment; throw <code>IndexOutOfBoundsException</code> if <code>pos</code> is out of range.
<code>int size()</code>	Return the number of objects in the linked list.
<code>List subList(int first, int last)</code>	Return the sublist of the linked list (not its copy) containing elements from <code>first</code> to <code>last-1</code> ; throw <code>IndexOutOfBoundsException</code> if either <code>first</code> or <code>last</code> and <code>IllegalArgumentException</code> if <code>last &lt; first</code> (inherited).
<code>Object[] toArray()</code>	Copy all objects from the linked list to a newly created array and return the array.

*Continues*

**FIGURE 3.25** (continued)

<code>Object[] toArray(Object a[])</code>	Copy all objects from the linked list to the array <code>a</code> if <code>a</code> is large enough or to a newly created array and return the array; throw <code>ArrayStoreException</code> if type of <code>a</code> is not a supertype of the type of every element in the linked list and <code>NullPointerException</code> if <code>a</code> is null.
<code>String toString()</code>	Return a string representation of the linked list that contains the string representation of all the objects.

**FIGURE 3.26** A program demonstrating the operation of `LinkedList` methods.

```
import java.io.*;
import java.util.LinkedList;

class TestLinkedLists {
    public static void main(String[] ar) {
        LinkedList lst1 = new LinkedList(); // lst1 = []
        lst1.addFirst(new Integer(4)); // lst1 = [4]
        lst1.addFirst(new Integer(5)); // lst1 = [5, 4]
        lst1.addLast(new Integer(6)); // lst1 = [5, 4, 6]
        lst1.addLast(new Integer(5)); // lst1 = [5, 4, 6, 5]
        System.out.println("lst1: " + lst1); // lst1 = [5, 4, 6, 5]
        System.out.println(lst1.lastIndexOf(new Integer(5))); // 3
        System.out.println(lst1.indexOf(new Integer(5))); // 0
        System.out.println(lst1.indexOf(new Integer(7))); // -1
        lst1.remove(new Integer(5)); // lst1 = [4, 6, 5]
        LinkedList lst2 = new LinkedList(lst1); // lst2 = [4, 6, 5]
        lst2.add(2, new Integer(8)); // lst2 = [4, 6, 8, 5]
        lst2.remove(new Integer(5)); // lst2 = [4, 6, 8]
        lst2.remove(1); // lst2 = [4, 8]
        System.out.println(lst2.getFirst() + " " + lst2.getLast()); // 4 8
        System.out.println(lst2.set(1, new Integer(7))); // 8, lst2 = [4, 7]
        Integer[] a1, b = {new Integer(1), new Integer(2)}; // b = [1, 2]
        for (int i = 0; i < b.length; i++)
            System.out.print(b[i] + " ");
        System.out.println();
        a1 = (Integer[]) lst2.toArray(b); // a1 = b = [4, 7]
        for (int i = 0; i < b.length; i++)
            System.out.print(b[i] + " ");
        System.out.println();
    }
}
```



**FIGURE 3.26** (continued)

```

    a1 = (Integer[]) lst1.toArray(b);           // a1 = [4, 6, 5], b = [4, 7]
    for (int i = 0; i < b.length; i++)
        System.out.print(b[i] + " ");
    System.out.println();
    for (int i = 0; i < a1.length; i++)
        System.out.print(a1[i] + " ");
    System.out.println();
    Object[] a2 = lst1.toArray();
    for (int i = 0; i < a2.length; i++)         // a2 = [4, 6, 5]
        System.out.print(a2[i] + " ");       // 4 6 5
    System.out.println();
    for (int i = 0; i < lst1.size(); i++)
        System.out.print(lst1.get(i) + " "); // 4 6 5
    System.out.println();
    for (java.util.Iterator it = lst1.iterator(); it.hasNext(); )
        System.out.print(it.next() + " ");    // 4 6 5
    System.out.println();
}
}

```

`toString()`, which prints the list by starting with the left bracket, prints elements of the list in sequence in the way specified by their own version of `toString()` (whether a built-in version or redefined by the user), separates all elements by commas, and ends printing with the right bracket. For example, the list consisting of numbers 1, 2, and 3 is printed as [1, 2, 3]. How can the output format be changed? One way is to redefine the method `toString()`. But this approach works just for printing. How can we find the largest element on the list? Or how can elements meeting certain conditions be counted? Or how can they be updated? These problems can be solved by processing the first element of the list and putting it at the end until all elements are processed.

Such a situation in the case of vectors uses the subscript operation: To access the element at position 5 of vector `v`, we simply use the expression `v[5]`. A similar role for linked lists is played by the method `get()`. But if we have two accesses in the row, say, `lst.get(5)`, `lst.get(6)`, then the search for position 5 begins from the beginning of the list for the first statement and again from the beginning of the list for the second statement. Instead, a temporary array can be created with the method `toArray()`. But this approach incurs unnecessary overhead in terms of space needed for the array and time needed to create it. A better approach is to use an iterator.

Iterators are objects that allow for access of elements of particular collections. The class `Iterator` defines three methods: `next()` to retrieve the next element of the collection for which the iterator is defined, `hasNext()` to check whether any elements are left for processing, and an optional `remove()` to remove from the

collection the most recently accessed element. An example of application of an iterator is given in Figures 3.26 and 3.31.

### 3.7.2 ArrayList

The `ArrayList` class is an array implementation of a list. For all practical purposes it is an equivalent of the class `Vector` except that the methods in the `Vector` class are synchronized, whereas methods in the `ArrayList` class are not. Like a vector, an array list is a flexible array that is automatically extended when required by insertion operations.

The class hierarchy in the package `java.util` is as follows:

`Object` ⇒ `AbstractCollection` ⇒ `AbstractList` ⇒ `LinkedList`

A list of methods of the `ArrayList` class is given in Figure 3.27 and an example of application of some methods is given in Figure 3.28.

**FIGURE 3.27** An alphabetical list of methods in the class `ArrayList`.

Method	Operation
<code>boolean add(Object ob)</code>	Insert object <code>ob</code> at the end of the array list.
<code>void add(int pos, Object ob)</code>	Insert object <code>ob</code> at position <code>pos</code> after shifting elements at positions following <code>pos</code> by one position; throw <code>IndexOutOfBoundsException</code> if <code>pos</code> is out of range.
<code>boolean addAll(Collection c)</code>	Add all the elements from the collection <code>c</code> to the end of the array list; return <code>true</code> if the array list was modified; throw <code>NullPointerException</code> if <code>c</code> is null.
<code>boolean addAll(int pos, Collection)</code>	Add all the elements from the collection <code>c</code> at the position <code>pos</code> of the array list after shifting the objects following position <code>pos</code> ; throw <code>IndexOutOfBoundsException</code> if <code>pos</code> is out of range and <code>NullPointerException</code> if <code>c</code> is null.
<code>ArrayList()</code>	Create an empty array list.
<code>ArrayList(Collection c)</code>	Create an array list with copies of elements from collection <code>c</code> ; throw <code>NullPointerException</code> if <code>c</code> is null.
<code>ArrayList(int initCap)</code>	Create an empty array list with capacity <code>initCap</code> ; throw <code>IllegalArgumentException</code> if <code>initCap</code> < 0.
<code>void clear()</code>	Remove all the objects from the array list.
<code>Object clone()</code>	Return the copy of the array list without cloning its elements.
<code>boolean contains(Object ob)</code>	Return <code>true</code> if the array list contains the object <code>ob</code> .
<code>boolean containsAll(Collection c)</code>	Return <code>true</code> if the array list contains all of the objects in the collection <code>c</code> ; throw <code>NullPointerException</code> if <code>c</code> is null (inherited).

**FIGURE 3.27** (continued)

<code>void ensureCapacity(int cap)</code>	If necessary, increase the capacity of the array list to accommodate at least <code>cap</code> elements.
<code>boolean equals(Object ob)</code>	Return <code>true</code> if the current array list and object <code>ob</code> are equal (inherited).
<code>Object get(int pos)</code>	Return the object at position <code>pos</code> ; throw <code>IndexOutOfBoundsException</code> if <code>pos</code> is out of range.
<code>int hashCode()</code>	Return the hash code for the array list (inherited).
<code>int indexOf(Object ob)</code>	Return the position of the first occurrence of object <code>ob</code> in the array list; return <code>-1</code> if <code>ob</code> is not found.
<code>boolean isEmpty()</code>	Return <code>true</code> if the array list contains no elements, <code>false</code> otherwise.
<code>Iterator iterator()</code>	Generate and return an iterator for the array list (inherited).
<code>int lastIndexOf(Object ob)</code>	Return the position of the last occurrence of object <code>ob</code> in the array list; return <code>-1</code> if <code>ob</code> is not found.
<code>ListIterator listIterator()</code>	Generate and return a list iterator for the array list initialized to position 0 (inherited).
<code>ListIterator listIterator(int n)</code>	Generate and return a list iterator for the array list initialized to position <code>n</code> ; throw <code>IndexOutOfBoundsException</code> if <code>n</code> is out of range (inherited).
<code>boolean remove(Object ob)</code>	Remove the first occurrence of <code>ob</code> in the array list and return <code>true</code> if <code>ob</code> was in the array list (inherited).
<code>Object remove(int pos)</code>	Remove the object at position <code>pos</code> ; throw <code>IndexOutOfBoundsException</code> if <code>pos</code> is out of range.
<code>boolean removeAll(Collection c)</code>	Remove from the array list all the objects contained in collection <code>c</code> ; return <code>true</code> if any element was removed; throw <code>NullPointerException</code> if <code>c</code> is null (inherited).
<code>void removeRange(int first, int last)</code>	Remove from the array list all the objects from position <code>first</code> to position <code>last - 1</code> .
<code>boolean retainAll(Collection c)</code>	Remove from the array list all objects that are not in the collection <code>c</code> ; return <code>true</code> if any object was removed; throw <code>NullPointerException</code> if <code>c</code> is null (inherited).
<code>Object set(int pos, Object ob)</code>	Assign object <code>ob</code> to position <code>pos</code> and return the object that occupied this position before the assignment; throw <code>IndexOutOfBoundsException</code> if <code>pos</code> is out of range.
<code>int size()</code>	Return the number of objects in the array list.

*Continues*

**FIGURE 3.27** (continued)

<code>List subList(int first, int last)</code>	Return the sublist of the array list (not its copy) containing elements from <code>first</code> to <code>last - 1</code> ; throw <code>IndexOutOfBoundsException</code> if either <code>first</code> or <code>last</code> and <code>IllegalArgumentException</code> if <code>last &lt; first</code> (inherited).
<code>Object[] toArray()</code>	Copy all objects from the array list to a newly created array and return the array.
<code>Object[] toArray(Object a[])</code>	Copy all objects from the array list to the array <code>a</code> if <code>a</code> is large enough or to a newly created array and return the array; throw <code>ArrayStoreException</code> if type of <code>a</code> is not a supertype of the type of every element in the array list and <code>NullPointerException</code> if <code>a</code> is null.
<code>void trimToSize()</code>	Trim the capacity of this array list to the list's current size.
<code>String toString()</code>	Return a string representation of the array list that contains the string representation of all the objects.

**FIGURE 3.28** A program demonstrating the operation of `ArrayList` methods.

```
import java.io.*;
import java.util.*;

class TestArrayList {
    public static void main(String[] ar) {
        ArrayList lst1 = new ArrayList();
        lst1.add(new Integer(4));
        lst1.add(new Integer(5));
        lst1.add(new Integer(6));
        lst1.add(new Integer(4));
        ArrayList lst2 = new ArrayList(4);
        lst2.add(new Integer(3));
        lst2.add(new Integer(4));
        lst2.add(new Character('a'));
        lst2.add(new Double(1.1));
        System.out.println(lst1);
        System.out.println(lst2);
        lst1.removeAll(lst2);
        // difference: [4, 5, 6, 4] and [3, 4, a, 1.1] ==> [5, 6]
        System.out.println(lst1);
    }
}
```

**FIGURE 3.28** (continued)

```

    lst1.add(0,new Integer(4));
    lst1.add(new Integer(4));
    lst1.retainAll(lst2);
    // intersection: [4, 5, 6, 4] and [3, 4, a, 1.1] ==> [4, 4]
    System.out.println(lst1);
    lst1.add(1,new Integer(5));
    lst1.add(2,new Integer(6));
    lst1.addAll(lst2);
    // union:
    // [4, 5, 6, 4] and [3, 4, a, 1.1] ==> [4, 5, 6, 4, 3, 4, a, 1.1]
    System.out.println(lst1);
    List lst3 = lst1.subList(2,5);
    System.out.println(lst3);    // [6, 4, 3]
    lst1.set(3,new Integer(10)); // update lst1 and lst3
    System.out.println(lst1);    // [4, 5, 6, 10, 3, 4, a, 1.1]
    System.out.println(lst3);    // [6, 10, 3]
    lst3.clear();
    System.out.println(lst1);    // [4, 5, 4, a, 1.1]
    System.out.println(lst3);    // []
}
}

```

## 3.8 CONCLUDING REMARKS

Linked lists have been introduced to overcome limitations of arrays by allowing dynamic allocation of necessary amounts of memory. Also, linked lists allow easy insertion and deletion of information because such operations have a local impact on the list. To insert a new element at the beginning of an array, all elements in the array have to be shifted to make room for the new item; hence, insertion has a global impact on the array. Deletion is the same. So should we always use linked lists instead of arrays?

Arrays have some advantages over linked lists, namely that they allow random accessing. To access the tenth node in a linked list, all nine preceding nodes have to be passed. In the array, we can go to the tenth cell immediately. Therefore, if an immediate access of any element is necessary, then an array is a better choice. This was the case with binary search, and it will be the case with most sorting algorithms (see Chapter 9). But if we are constantly accessing only some elements—the first, the second, the last, and the like—and if changing the structure is the core of an algorithm, then using a linked list is a better option. A good example is a queue, which is discussed in the next chapter.

Another advantage in the use of arrays is space. To hold items in arrays, the cells have to be of the size of the items. In linked lists, we store one item per node, and the node also includes at least one reference field; in doubly linked lists, the node contains

two reference fields. For large linked lists, a significant amount of memory is needed to store the references. Therefore, if a problem does not require many shifts of data, then having an oversized array may not be wasteful at all if its size is compared to the amount of space needed for the linked structure storing the same data as the array.

### 3.9 CASE STUDY: A LIBRARY

This case study is a program that can be used in a small library to include new books in the library, to check out books to people, and to return them.

As this program is a practice in the use of linked lists, almost everything is implemented in terms of such lists. But to make the program more interesting, it uses linked lists of linked lists that also contain cross-references (see Figure 3.29).

First, there could be a list including all authors of all books in the library. However, searching through such a list can be time-consuming, so the search can be sped up by choosing at least one of the two following strategies:

- The list can be ordered alphabetically, and the search can be interrupted if we find the name, if we encounter an author's name greater than the one we are searching for, or if we reach the end of list.
- We can use an array of references to the author structures indexed with letters; each slot of the array points to the linked list of authors whose names start with the same letter.

The best strategy is to combine both approaches. However, in this case study, only the second approach is used, and the reader is urged to amplify the program by adding the first approach. Note that the articles *a*, *an*, and *the* at the beginning of the titles should be disregarded during the sorting operation.

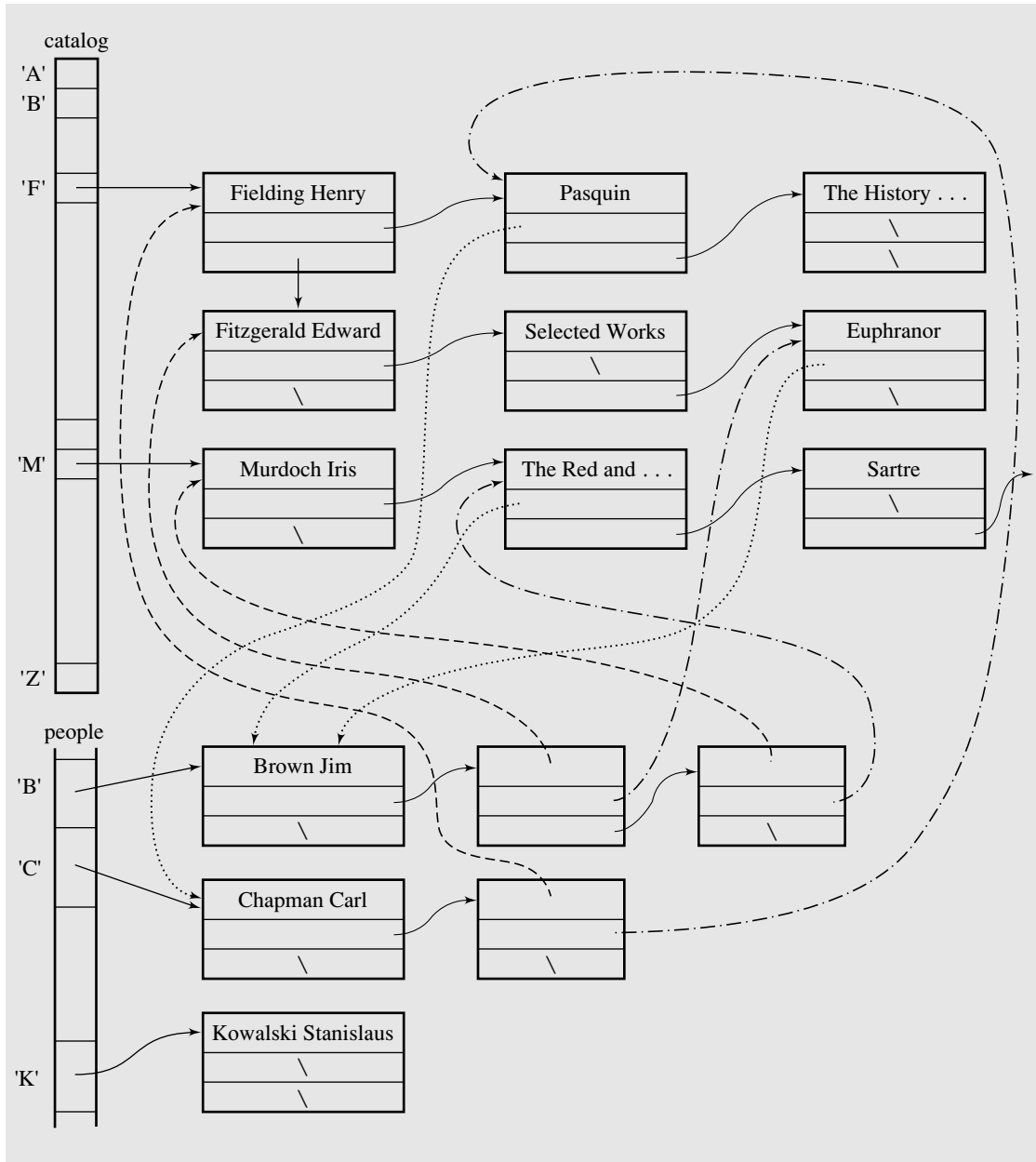
The program uses an array `catalog` of all the authors of the books included in the library and an array `people` of all the people who have used the library at least once. Both arrays are indexed with letters so that, for instance, `catalog[ ' F ' ]` refers to a linked list of all the authors whose names start with F.

Because we can have several books by the same author, one of the fields of the author node refers to the list of books by this author that can be found in the library. Similarly, because each patron can check out several books, the patron node contains a reference to the list of books currently checked out by this patron. This fact is indicated by setting the `patron` field of the checked-out book to the node pertaining to the patron who is taking the book out.

Books can be returned, and that fact should be reflected by removing the appropriate `CheckedOutBook` nodes from the list of the checked-out books of the patron who returns them. The `Patron` field in the node related to the book that is being returned has to be reset to null.

The program defines four classes: `Author`, `Book`, `Patron`, and `CheckedOutBook`. Java's `LinkedList` class is used to define three more classes: `AuthorList`, `BookList`, and `PatronList`. To use the `LinkedList` class to generate and process a specific linked list, the generic methods need to be accommodated to a specific class. In particular, because the way of comparing instances of the first four library classes and

**FIGURE 3.29** Linked lists indicating library status.



the way of displaying them vary from one class to another, each of the four classes includes a definition of the method `equals()` to override the generic definition used in class `Object`. To display data, two classes override the generic method `toString()`. However, this allows us to print information extracted from one node of a linked list. For two classes, however, a method is needed to print linked lists  $L_1$  of linked lists  $L_2$  (e.g., a list of patrons, each node of which refers to a linked list of checked-out books). It is possible to convert for each node of  $L_1$  to string not only information contained directly in the node, but also all the information on the linked list accessed from the node. This is a way of overriding the method `toString()` defined for `LinkedList`. For some variety, the three classes derived from `LinkedList` define their own versions of the `display()` method. `AuthorList` displays the list of authors by first converting the list into an array and then processing the array with the subscripting operator. `BookList` uses the `get()` method to access the elements of the list of books. Finally, `PatronList` uses an iterator to perform the same task. Note that `BookList` is used generically to create two types of lists: a linked list of books in `Author` objects and checked-out books in `Patron` objects.

The program allows the user to choose one of the five operations: adding a book to the library, checking a book out, returning it, showing the current status of the library, and exiting the program. The operation is chosen after a menu is displayed and a proper number is entered. The cycle of displaying the menu and executing an elected operation ends with choosing the exit option. Here is an example of the status for a situation shown in Figure 3.29.

```
Library has the following books:
```

```
Fielding Henry
  * Pasquin - checked out to Chapman Carl
  * The History of Tom Jones
Fitzgerald Edward
  * Selected Works
  * Euphranor - checked out to Brown Jim
Murdoch Iris
  * The Red and the Green - checked out to Brown Jim
  * Sartre
  * The Bell
```

```
The following people are using the library:
```

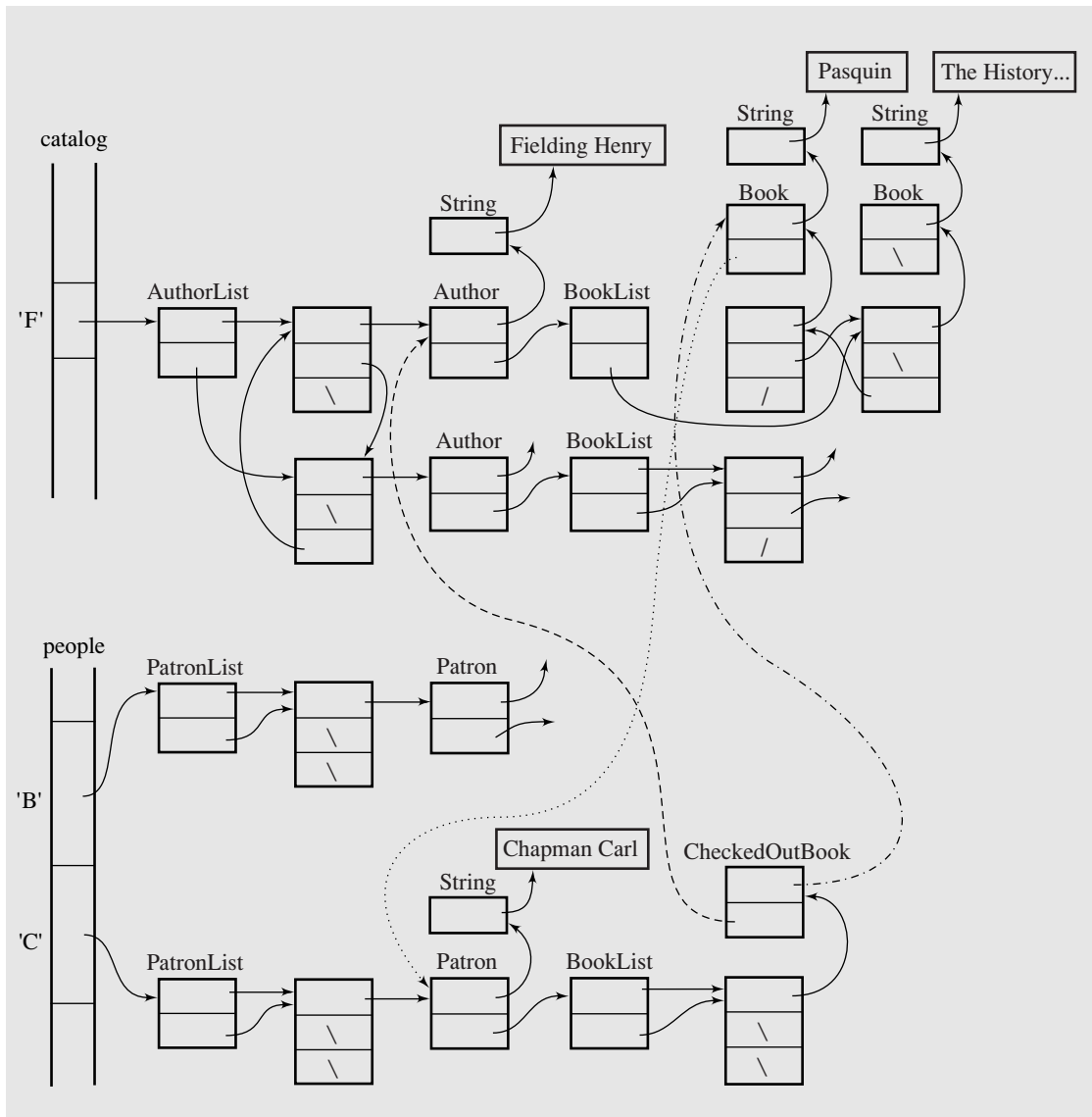
```
Brown Jim has the following books
  * Fitzgerald Edward, Euphranor
  * Murdoch Iris, The Red and the Green
Chapman Carl has the following books
  * Fielding Henry, Pasquin
Kowalski Stanislaus has no books
```

Note that the diagram in Figure 3.29 reflects only the logic of the use of the linked lists and thus is significantly simplified. In a more realistic diagram, we need to take into account the fact that object data fields do not hold objects but only references to



them. Also, each object that is an instance of the generic `LinkedList` class refers to a linked list in which each node refers to an object. A fragment of Figure 3.29 is shown in Figure 3.30 with implementation details shown more explicitly. The listing for the library program is shown in Figure 3.31.

**FIGURE 3.30** Fragment of structure from Figure 3.29 with all the objects used in the implementation.



**FIGURE 3.31** The library program.

```
/** ***** Library.java ***** */
import java.io.*;
import java.util.LinkedList;

class Author {
    public String name;
    public BookList books = new BookList();
    public Author() {
    }
    public boolean equals(Object node) {
        return name.equals(((Author) node).name);
    }
    public void display() {
        System.out.println(name);
        books.display();
    }
}

class Book {
    public String title;
    public Patron patron = null;
    public Book() {
    }
    public boolean equals(Object node) {
        return title.equals(((Book) node).title);
    }
    public String toString() {
        return " * " + title +
            (patron != null ? " - checked out to " + patron.name : "") +
            "\n";
    }
}

class CheckedOutBook {
    public Author author = null;
    public Book book = null;
    public CheckedOutBook() {
    }
    public boolean equals(Object node) {
        return book.title.equals(((CheckedOutBook) node).book.title) &&
            author.name.equals(((CheckedOutBook) node).author.name);
    }
}
```

**FIGURE 3.31** (continued)

```

    public String toString() {
        return "    * " + author.name + ", " + book.title + "\n";
    }
}

class Patron {
    public String name;
    public BookList books = new BookList();
    public Patron() {
    }
    public boolean equals(Object node) {
        return name.equals(((Patron) node).name);
    }
    public void display() {
        if (!books.isEmpty()) {
            System.out.println(name + " has the following books:");
            books.display();
        }
        else System.out.print(name + " has no books");
    }
}

class AuthorList extends LinkedList {
    public AuthorList() {
        super();
    }
    public void display() {
        Object[] authors = toArray();
        for (int i = 0; i < authors.length; i++)
            ((Author)authors[i]).display();
    }
}

class BookList extends LinkedList {
    public BookList() {
        super();
    }
    public void display() {
        for (int i = 0; i < size(); i++)
            System.out.print(get(i));
    }
}

```

*Continues*

**FIGURE 3.31** (continued)

```

class PatronList extends LinkedList {
    public PatronList() {
        super();
    }
    public void display() {
        for (java.util.Iterator it = iterator(); it.hasNext(); )
            ((Patron)it.next()).display();
    }
}

class Library {
    private AuthorList[] catalog = new AuthorList[(int)('Z'+1)];
    private PatronList[] people = new PatronList[(int)('Z'+1)];
    private String input;
    private BufferedReader buffer = new BufferedReader(
        new InputStreamReader(System.in));

    public Library() {
        for (int i = 0; i <= (int) 'Z'; i++) {
            catalog[i] = new AuthorList();
            people[i] = new PatronList();
        }
    }
    private String getString(String msg) {
        System.out.print(msg + " ");
        System.out.flush();
        try {
            input = buffer.readLine();
        } catch (IOException io) {
        }
        return input.substring(0,1).toUpperCase() + input.substring(1);
    }
    private void status() {
        System.out.println("Library has the following books:\n ");
        for (int i = (int) 'A'; i <= (int) 'Z'; i++)
            if (!catalog[i].isEmpty())
                catalog[i].display();
        System.out.println("\nThe following people are using the
            "library:\n ");
        for (int i = (int) 'A'; i <= (int) 'Z'; i++)
            if (!people[i].isEmpty())
                people[i].display();
    }
}

```

**FIGURE 3.31** (continued)

```

private void includeBook() {
    Author newAuthor = new Author();
    int oldAuthor;
    Book newBook = new Book();
    newAuthor.name = getString("Enter author's name:");
    newBook.title = getString("Enter the title of the book:");
    oldAuthor = catalog[(int)
        newAuthor.name.charAt(0)].indexOf(newAuthor);
    if (oldAuthor == -1) {
        newAuthor.books.add(newBook);
        catalog[(int) newAuthor.name.charAt(0)].add(newAuthor);
    }
    else ((Author)catalog[(int)
        newAuthor.name.charAt(0)].get(oldAuthor)).
        books.add(newBook);
}
private void checkOutBook() {
    Patron patron = new Patron(), patronRef; // = new Patron();
    Author author = new Author(), authorRef = new Author();
    Book book = new Book();
    int patronIndex, bookIndex = -1, authorIndex = -1;
    patron.name = getString("Enter patron's name:");
    while (authorIndex == -1) {
        author.name = getString("Enter author's name:");
        authorIndex = catalog[(int)
            author.name.charAt(0)].indexOf(author);
        if (authorIndex == -1)
            System.out.println("Misspelled author's name");
    }
    while (bookIndex == -1) {
        book.title = getString("Enter the title of the book:");
        authorRef = (Author) catalog[(int)
            author.name.charAt(0)].get(authorIndex);
        bookIndex = authorRef.books.indexOf(book);
        if (bookIndex == -1)
            System.out.println("Misspelled title");
    }
    Book bookRef = (Book) authorRef.books.get(bookIndex);
    CheckedOutBook bookToCheckOut = new CheckedOutBook();
    bookToCheckOut.author = authorRef;
    bookToCheckOut.book = bookRef;
}

```

*Continues*

**FIGURE 3.31** (continued)

```

        patronIndex = people[(int)
            patron.name.charAt(0)].indexOf(patron);
    if (patronIndex == -1) { // a new patron in the library;
        patron.books.add(bookToCheckOut);
        people[(int) patron.name.charAt(0)].add(patron);
        bookRef.patron = (Patron) people[(int)
patron.name.charAt(0)].getFirst();
    }
    else {
        patronRef = (Patron) people[(int)
            patron.name.charAt(0)].get(patronIndex);
        patronRef.books.add(bookToCheckOut);
        bookRef.patron = patronRef;
    }
}
private void returnBook() {
    Patron patron = new Patron();
    Book book = new Book();
    Author author = new Author(), authorRef = new Author();
    int patronIndex = -1, bookIndex = -1, authorIndex = -1;
    while (patronIndex == -1) {
        patron.name = getString("Enter patron's name:");
        patronIndex = people[(int)
            patron.name.charAt(0)].indexOf(patron);
        if (patronIndex == -1)
            System.out.println("Patron's name misspelled");
    }
    while (authorIndex == -1) {
        author.name = getString("Enter author's name:");
        authorIndex = catalog[(int)
            author.name.charAt(0)].indexOf(author);
        if (authorIndex == -1)
            System.out.println("Misspelled author's name");
    }
    while (bookIndex == -1) {
        book.title = getString("Enter the title of the book:");
        authorRef = (Author) catalog[(int)
            author.name.charAt(0)].get(authorIndex);
        bookIndex = authorRef.books.indexOf(book);
        if (bookIndex == -1)
            System.out.println("Misspelled title");
    }
}

```

**FIGURE 3.31** (continued)

```
CheckedOutBook checkedOutBook = new CheckedOutBook();
checkedOutBook.author = authorRef;
checkedOutBook.book = (Book) authorRef.books.get(bookIndex);
((Book)authorRef.books.get(bookIndex)).patron = null;
((Patron)people[(int) patron.name.charAt(0)].get(patronIndex)).
    books.remove(checkedOutBook);
}
public void run() {
    while (true) {
        char option = getString("\nEnter one of the following" +
            "options:\n" +
            "1. Include a book in the catalog\n" +
            "2. Check out a book\n" +
            "3. Return a book\n4. Status\n5." +
            "Exit\n" +
            "Your option:").charAt(0);

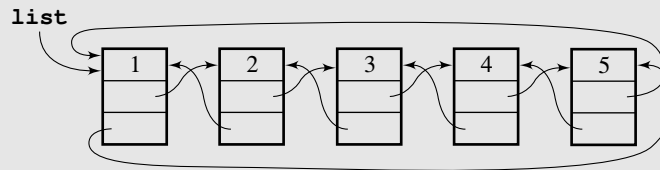
        switch (option) {
            case '1': includeBook(); break;
            case '2': checkOutBook(); break;
            case '3': returnBook(); break;
            case '4': status(); break;
            case '5': return;
            default: System.out.println("Wrong option, try again.");
        }
    }
}
public static void main(String args[]) {
    (new Library()).run();
}
}
```

### 3.10 EXERCISES

1. Assume that a circular doubly linked list has been created, as in Figure 3.32. After each of the following assignments, indicate changes made in the list by showing which links have been modified. Process these assignments in sequence; that is, the second assignment should make changes in the list modified by the first assignment, and so on.

```
list.next.next.next = list.prev;
list.prev.prev.prev = list.next.next.next.prev;
list.next.next.next.prev = list.prev.prev.prev;
list.next = list.next.next;
list.next.prev.next = list.next.next.next;
```

**FIGURE 3.32** A circular doubly linked list.



2. How many nodes does the shortest linked list have? The longest linked list?
3. The linked list in Figure 3.11 was created in Section 3.2 with three assignments. Create this list with only one assignment.
4. Merge two ordered singly linked lists of integers into one ordered list.
5. Delete an  $i$ th node on a linked list. Be sure that such a node exists.
6. Delete from list  $L_1$  nodes whose positions are to be found in an ordered list  $L_2$ . For instance, if  $L_1 = (A B C D E)$  and  $L_2 = (2 4 8)$ , then the second and the fourth nodes are to be deleted from list  $L_1$  (the eighth node does not exist), and after deletion,  $L_1 = (A C E)$ .
7. Delete from list  $L_1$  nodes occupying positions indicated in ordered lists  $L_2$  and  $L_3$ . For instance, if  $L_1 = (A B C D E)$ ,  $L_2 = (2 4 8)$ , and  $L_3 = (2 5)$ , then after deletion,  $L_1 = (A C)$ .
8. Delete from an ordered list  $L$  nodes occupying positions indicated in list  $L$  itself. For instance, if  $L = (1 3 5 7 8)$ , then after deletion,  $L = (1 7)$ .
9. Suggest an array implementation of linked lists.
10. Write a method to check whether two singly linked lists have the same contents.
11. Write a method to reverse a singly linked list using only one pass through the list.



12. Write a method to insert a new node into a singly linked list (a) before and (b) after a node referred by `p` in this list (possibly the first or the last). Do not use a loop in either operation.
13. Attach a singly linked list to the end of another singly linked list.
14. Put numbers in a singly linked list in ascending order. Use this operation to find the median in the list of numbers.
15. How can a singly linked list be implemented so that insertion requires no test for whether `head` is null?
16. Insert a node exactly in the middle of a doubly linked list.
17. Write code for class `IntCircularSLList` for a circular singly linked list that includes equivalents of the methods listed in Figure 3.2.
18. Write code for class `IntCircularDLList` for a circular doubly linked list that includes equivalents of the methods listed in Figure 3.2.
19. How likely is the worst case for searching a skip list to occur?
20. Consider the move-to-front, transpose, count, and ordering methods.
  - a. In what case is a list maintained by these methods not changed?
  - b. In what case do these methods require an exhaustive search of lists for each search, assuming that only elements in the list are searched for?
21. In the discussion of self-organizing lists, only the number of comparisons was considered as the measure of different methods' efficiency. This measure can, however, be greatly affected by a particular implementation of the list. Discuss how the efficiency of the move-to-front, transpose, count, and ordering methods are affected in the case when the list is implemented as
  - a. an array
  - b. a singly linked list
  - c. a doubly linked list
22. For doubly linked lists, there are two variants of the move-to-front and transpose methods (Matthews, Rotem, & Bretholz 1980). A *move-to-end* method moves an element being accessed to the end from which the search started. For instance, if the doubly linked list is a list of items  $A B C D$  and the search starts from the right end to access node  $C$ , then the reorganized list is  $A B D C$ . If the search for  $C$  started from the left end, the resulting list is  $C A B D$ .  
 The *swapping* technique transposes a node with its predecessor also with respect to the end from which the search started (Ng & Oommen 1989). Assuming that only elements of the list are in the data, what is the worst case for a move-to-end doubly linked list when the search is made alternately from the left and from the right? For a swapping list?
23. What is the maximum number of comparisons for optimal search for the 14 letters shown in Figure 3.20?

24. Adapt the binary search to linked lists. How efficient can this search be?
25. In the second implementation of storing student grades, two pairs of two-dimensional arrays are used: `classesTaken1` and `classesTaken2`, and `studentsInClasses1` and `studentsInClasses2` (Figure 3.23). Why not use just two arrays, `classesTaken` and `studentsInClasses`, of objects with two data fields?

## 3.11

## PROGRAMMING ASSIGNMENTS

1. Farey fractions of level one are defined as sequence  $(\frac{0}{1}, \frac{1}{1})$ . This sequence is extended in level two to form a sequence  $(\frac{0}{1}, \frac{1}{2}, \frac{1}{1})$ , sequence  $(\frac{0}{1}, \frac{1}{3}, \frac{1}{2}, \frac{2}{3}, \frac{1}{1})$  at level three, sequence  $(\frac{0}{1}, \frac{1}{4}, \frac{1}{3}, \frac{1}{2}, \frac{2}{3}, \frac{3}{4}, \frac{1}{1})$  at level four, so that at each level  $n$ , a new fraction  $\frac{a+b}{c+d}$  is inserted between two neighbor fractions  $\frac{a}{c}$  and  $\frac{b}{d}$  only if  $c + d \leq n$ . Write a program which for a number  $n$  entered by the user creates—by constantly extending it—a linked list of fractions at level  $n$  and then displays them.
2. Write a simple airline ticket reservation program. The program should display a menu with the following options: reserve a ticket, cancel a reservation, check whether a ticket is reserved for a particular person, and display the passengers. The information is maintained on an alphabetized linked list of names. In a simpler version of the program, assume that tickets are reserved for only one flight. In a fuller version, place no limit on the number of flights. Create a linked list of flights with each node including a reference to a linked list of passengers.
3. Read Section 12.1 about sequential-fit methods. Implement the discussed methods with linked lists and compare their efficiency.
4. Write a program to simulate managing files on disk. Define the disk as a one-dimensional array `disk` of size `numOfSectors*sizeOfSector`, where `sizeOfSector` indicates the number of characters stored in one sector. (For the sake of debugging, make it a very small number.) A pool of available sectors is kept in a linked list `sectors` of three field structures: two fields to indicate ranges of available sectors and one `next` field. Files are kept in a linked list `files` of four field structures: file name, the number of characters in the file, a reference to a linked list of sectors where the contents of the file can be found, and the `next` field.
  - a. In the first part, implement methods to save and delete files. Saving files requires claiming a sufficient number of sectors from `pool`, if available. The sectors may not be contiguous, so the linked list assigned to the file may contain several nodes. Then the contents of the file have to be written to the sectors assigned to the file. Deletion of a file only requires removing the nodes corresponding with this file (one from `files` and the rest from its own linked list of sectors) and transferring the sectors assigned to this file back to `pool`. No changes are made in `disk`.

b. File fragmentation slows down file retrieval. In the ideal situation, one cluster of sectors is assigned to one file. However, after many operations with files, it may not be possible. Extend the program to include a method `together()` to transfer files to contiguous sectors; that is, to create a situation illustrated in Figure 3.33. Fragmented files `file1` and `file2` occupy only one cluster of sectors after `together()` is finished. However, particular care should be taken not to overwrite sectors occupied by other files. For example, `file1` requires eight sectors; five sectors are free at the beginning of `pool`, but sectors 5 and 6 are occupied by `file2`. Therefore, a file `f` occupying such sectors has to be located first by scanning `files`. The contents of these sectors must be transferred to unoccupied positions, which requires updating the sectors belonging to `f` in the linked list; only then can the released sectors be utilized. One way of accomplishing this is by copying from the area into which one file is copied chunks of sectors of another file into an area of the disk large enough to accommodate these chunks. In the example in Figure 3.33, contents of `file1` first are copied to sectors 0 through 4, and then copying is temporarily suspended because sector 5 is occupied. Thus, contents of sectors 5 and 6 are moved to sectors 12 and 14, and the copying of `file1` is resumed.

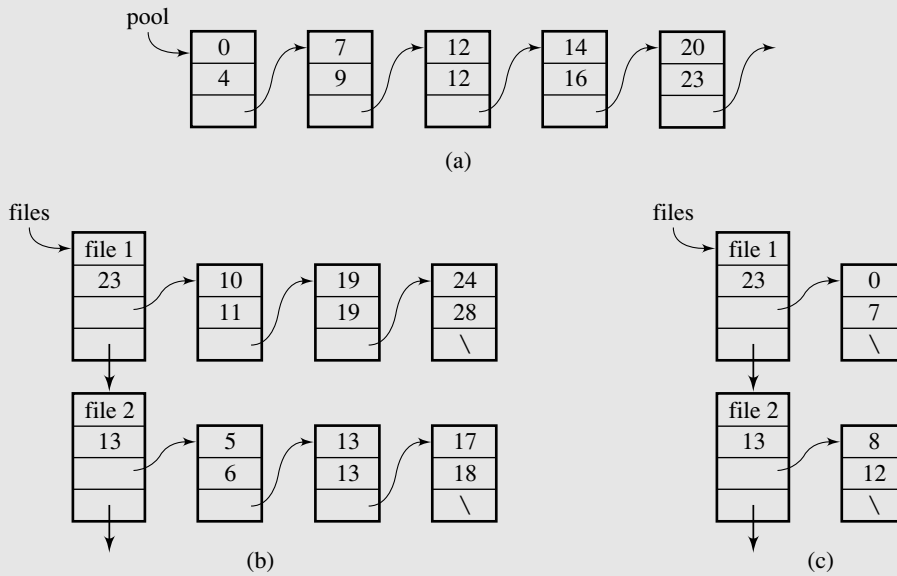
5. Write a simple line editor. Keep the entire text on a linked list, one line in a separate node. Start the program with entering `EDIT file`, after which a prompt appears along with the line number. If the letter `I` is entered with a number `n` following it, then insert the text to be followed before line `n`. If `I` is not followed by a number, then insert the text before the current line. If `D` is entered with two numbers `n` and `m`, one `n`, or no number following it, then delete lines `n` through `m`, line `n`, or the current line. Do the same with the command `L`, which stands for listing lines. If `A` is entered, then append the text to the existing lines. Entry `E` signifies exit and saving the text in a file. Here is an example:

```

EDIT testfile
1> The first line
2>
3> And another line
4> I 3
3> The second line
4> One more line
5> L
1> The first line
2>
3> The second line
4> One more line
5> And another line // This is now line 5, not 3;
5> D 2 // line 5, since L was issued from line 5;
4> L // line 4, since one line was deleted;
1> The first line
2> The second line // this and the following lines
3> One more line // now have new numbers;
4> And another line
4> E

```

**FIGURE 3.33** Linked lists used to allocate disk sectors for files: (a) a pool of available sectors; two files (b) before and (c) after putting them in contiguous sectors; the situation in sectors of the disk (d) before and (e) after this operation.



0	1	2	3	4	5	6	7	8	9
					222	222			
10	11	12	13	14	15	16	17	18	19
111	111		222				222	2	111
20	21	22	23	24	25	26	27	28	29
				111	111	111	111	11	

(d)

0	1	2	3	4	5	6	7	8	9
111	111	111	111	111	111	111	11	222	222
10	11	12	13	14	15	16	17	18	19
222	222	2	222	222			222	2	111
20	21	22	23	24	25	26	27	28	29
				111	111	111	111	11	

(e)

6. Extend the case study program in this chapter to have it store all the information in the file `Library.dat` at exit and initialize all the linked lists using this information at the invocation of the program. Also, extend it by adding more error checking, such as not allowing the same book to be checked out at the same time to more than one patron or not including the same patron more than once in the library.
7. Test the efficiency of skip lists. In addition to the methods given in this chapter, implement `skipListDelete()` and then compare the number of node accesses in searching, deleting, and inserting for large numbers of elements. Compare this efficiency with the efficiency of linked lists and ordered linked lists. Test your program on a randomly generated order of operations to be executed on the elements. These elements should be processed in random order. Then try your program on nonrandom samples.



## BIBLIOGRAPHY

Bentley, Jon L., and McGeoch, Catherine C., “Amortized Analyses of Self-Organizing Sequential Search Heuristics,” *Communications of the ACM* 28 (1985), 404–411.

Foster, John M., *List Processing*, London: MacDonald, 1967.

Hansen, Wilfred J., “A Predecessor Algorithm for Ordered Lists,” *Information Processing Letters* 7 (1978), 137–138.

Hester, James H., and Hirschberg, Daniel S., “Self-Organizing Linear Search,” *Computing Surveys* 17 (1985), 295–311.

Matthews, D., Rotem, D., and Bretholz, E., “Self-Organizing Doubly Linked Lists,” *International Journal of Computer Mathematics* 8 (1980), 99–106.

Ng, D. T. H., and Oommen, B. J., “Generalizing Singly-Linked List Reorganizing Heuristics for Doubly-Linked Lists,” in Kreczmar, A., and Mirkowska, G. (eds.), *Mathematical Foundations of Computer Science 1989*, Berlin: Springer, 1989, 380–389.

Pugh, William, “Skip Lists: A Probabilistic Alternative to Balanced Trees,” *Communications of the ACM* 33 (1990), 668–676.

Rivest, Ronald, “On Self-Organizing Sequential Search Heuristics,” *Communications of the ACM* 19 (1976), No. 2, 63–67.

Sleator, Daniel D., and Tarjan, Robert E., “Amortized Efficiency of List Update and Paging Rules,” *Communications of the ACM* 28 (1985), 202–208.

Wilkes, Maurice V., “Lists and Why They Are Useful,” *Computer Journal* 7 (1965), 278–281.

# 4

# Stacks and Queues

As the first chapter explained, abstract data types allow us to delay the specific implementation of a data type until it is well understood what operations are required to operate on the data. In fact, these operations determine which implementation of the data type is most efficient in a particular situation. This situation is illustrated by two data types, stacks and queues, which are described by a list of operations. Only after the list of the required operations is determined do we present some possible implementations and compare them.

## 4.1

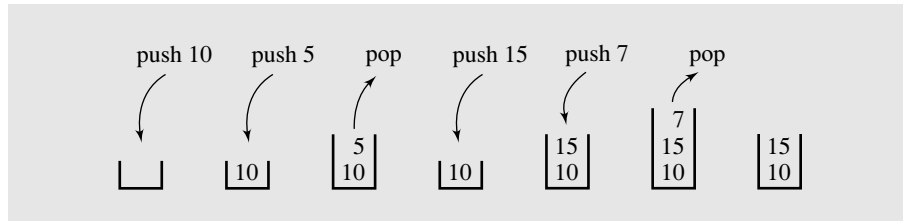
## STACKS

A *stack* is a linear data structure that can be accessed only at one of its ends for storing and retrieving data. Such a stack resembles a stack of trays in a cafeteria: New trays are put on the top of the stack and taken off the top. The last tray put on the stack is the first tray removed from the stack. For this reason, a stack is called an *LIFO* structure: last in/first out.

A tray can be taken only if there are trays on the stack, and a tray can be added to the stack only if there is enough room; that is, if the stack is not too high. Therefore, a stack is defined in terms of operations that change its status and operations that check this status. The operations are as follows:

- *clear()*—Clear the stack.
- *isEmpty()*—Check to see if the stack is empty.
- *push(el)*—Put the element *el* on the top of the stack.
- *pop()*—Take the topmost element from the stack.
- *topEl()*—Return the topmost element in the stack without removing it.

A series of push and pop operations is shown in Figure 4.1. After pushing number 10 onto an empty stack, the stack contains only this number. After pushing 5 on the stack, the number is placed on top of 10 so that, when the popping operation is

**FIGURE 4.1** A series of operations executed on a stack.

executed, 5 is removed from the stack, because it arrived after 10, and 10 is left on the stack. After pushing 15 and then 7, the topmost element is 7, and this number is removed when executing the popping operation, after which the stack contains 10 at the bottom and 15 above it.

Generally, the stack is very useful in situations when data have to be stored and then retrieved in reverse order. One application of the stack is in matching delimiters in a program. This is an important example because delimiter matching is part of any compiler: No program is considered correct if the delimiters are mismatched.

In Java programs, we have the following delimiters: parentheses “(” and “)”, square brackets “[” and “]”, curly brackets “{” and “}”, and comment delimiters “/\*” and “\*/”. Here are examples of Java statements that use delimiters properly:

```
a = b + (c - d) * (e - f);
g[10] = h[i[9]] + (j + k) * l;
while (m < (n[8] + o)) { p = 7; /* initialize p */ r = 6; }
```

These examples are statements in which mismatching occurs:

```
a = b + (c - d) * (e - f));
g[10] = h[i[9]] + j + k) * l;
while (m < (n[8] + o)) { p = 7; /* initialize p */ r = 6; }
```

A particular delimiter can be separated from its match by other delimiters; that is, delimiters can be nested. Therefore, a particular delimiter is matched up only after all the delimiters following it and preceding its match have been matched. For example, in the condition of the loop

```
while (m < (n[8] + o))
```

the first opening parenthesis must be matched with the last closing parenthesis, but this is done only after the second opening parenthesis is matched with the next to last closing parenthesis; this, in turn, is done after the opening square bracket is matched with the closing bracket.

The delimiter matching algorithm reads a character from a Java program and stores it on a stack if it is an opening delimiter. If a closing delimiter is found, the delimiter is compared to a delimiter popped off the stack. If they match, processing continues; if not, processing discontinues by signaling an error. The processing of

the Java program ends successfully after the end of the program is reached and the stack is empty. Here is the algorithm:

```

delimiterMaching(file)
  read character ch from file;
  while not end of file
    if ch is '(', '[', or '{'
      push(ch);
    else if ch is '/'
      read the next character;
      if this character is '*'
        skip all characters until "*" is found and report an error
        if the end of file is reached before "*" is encountered;
      else ch = the character read in;
        continue; // go to the beginning of the loop;
    else if ch is ')', ']', or '}'
      if ch and popped off delimiter do not match
        failure;
  // else ignore other characters;
  read next character ch from file;
  if stack is empty
    success;
  else failure;

```

Figure 4.2 shows the processing that occurs when applying this algorithm to the statement

```
s=t[5]+u/(v*(w+y));
```

The first column in Figure 4.2 shows the contents of the stack at the end of the loop before the next character is input from the program file. The first line shows the initial situation in the file and on the stack. Variable *ch* is initialized to the first character of the file, letter *s*, and in the first iteration of the loop, the character is simply ignored. This situation is shown in the second row in Figure 4.2. Then the next character, equal sign, is read. It is also ignored and so is the letter *t*. After reading the left bracket, the bracket is pushed onto the stack so that the stack now has one element, the left bracket. Reading digit 5 does not change the stack, but after the right bracket becomes the value of *ch*, the topmost element is popped off the stack and compared with *ch*. Because the popped off element (left bracket) matches *ch* (right bracket), the processing of input continues. After reading and discarding the letter *u*, a slash is read and the algorithm checks whether it is part of the comment delimiter by reading the next character, a left parenthesis. Because the character read in is not an asterisk, the slash is not a beginning of a comment, so *ch* is set to left parenthesis. In the next iteration, this parenthesis is pushed onto the stack and processing continues, as shown in Figure 4.2. After reading the last character, a semicolon, the loop is exited and the stack is checked. Because it is empty (no unmatched delimiters are left), success is pronounced.

As another example of stack application, consider adding very large numbers. The largest magnitude of integers is limited, so we are not able to add



**FIGURE 4.2** Processing the statement `s=t[5]+u/(v*(w+y));` with the algorithm `delimiterMatching()`.

Stack	Nonblank Character Read	Input Left
empty		<code>s = t[5] + u / (v * (w + y));</code>
empty	<code>s</code>	<code>= t[5] + u / (v * (w + y));</code>
empty	<code>=</code>	<code>t[5] + u / (v * (w + y));</code>
empty	<code>t</code>	<code>[5] + u / (v * (w + y));</code>
[ ]	<code>[</code>	<code>5] + u / (v * (w + y));</code>
[ ]	<code>5</code>	<code>] + u / (v * (w + y));</code>
empty	<code>]</code>	<code>+ u / (v * (w + y));</code>
empty	<code>+</code>	<code>u / (v * (w + y));</code>
empty	<code>u</code>	<code>/ (v * (w + y));</code>
empty	<code>/</code>	<code>(v * (w + y));</code>
[ (	<code>(</code>	<code>v * (w + y));</code>
[ (	<code>v</code>	<code>* (w + y));</code>
[ (	<code>*</code>	<code>(w + y));</code>
[ (		
[ (	<code>(</code>	<code>w + y));</code>
[ (		
[ (	<code>w</code>	<code>+y));</code>
[ (		
[ (	<code>+</code>	<code>y));</code>
[ (		
[ (	<code>y</code>	<code>));</code>
[ (	<code>)</code>	<code>);</code>
empty	<code>)</code>	<code>;</code>
empty	<code>;</code>	

18,274,364,583,929,273,748,459,595,684,373 and 8,129,498,165,026,350,236, because integer variables cannot hold such large values, let alone their sum. The problem can be solved if we treat these numbers as strings of numerals, store the numbers corresponding to these numerals on two stacks, and then perform addition by popping numbers from the stacks. The pseudocode for this algorithm is as follows:

```

addingLargeNumbers ( )
    read the numerals of the first number and store the numbers corresponding to
    them on one stack;
    read the numerals of the second number and store the numbers corresponding
    to them on another stack;
result = 0;
while at least one stack is not empty
    pop a number from each nonempty stack and add them to result;
    push the unit part on the result stack;
    store carry in result;
    push carry on the result stack if it is not zero;
    pop numbers from the result stack and display them;

```

Figure 4.3 shows an example of the application of this algorithm. In this example, numbers 592 and 3,784 are added.

1. First, numbers corresponding to digits composing the first number are pushed onto `operandStack1` and numbers corresponding to the digits of 3,784 are pushed onto `operandStack2`. Note the order of digits on the stacks.
2. Numbers 2 and 4 are popped from the stacks, and the result, 6, is pushed onto `resultStack`.
3. Numbers 9 and 8 are popped from the stacks, and the unit part of their sum, 7, is pushed onto `resultStack`; the tens part of the result, 1, is retained as a carry in the variable `result` for subsequent addition.
4. Numbers 5 and 7 are popped from the stacks, added to the carry, and the unit part of the result, 3, is pushed onto `resultStack`, and the carry, 1, becomes a value of the variable `result`.
5. One stack is empty, so a number is popped from the nonempty stack, added to carry, and the result is stored on `resultStack`.
6. Both operand stacks are empty, so the numbers from `resultStack` are popped and printed as the final result.

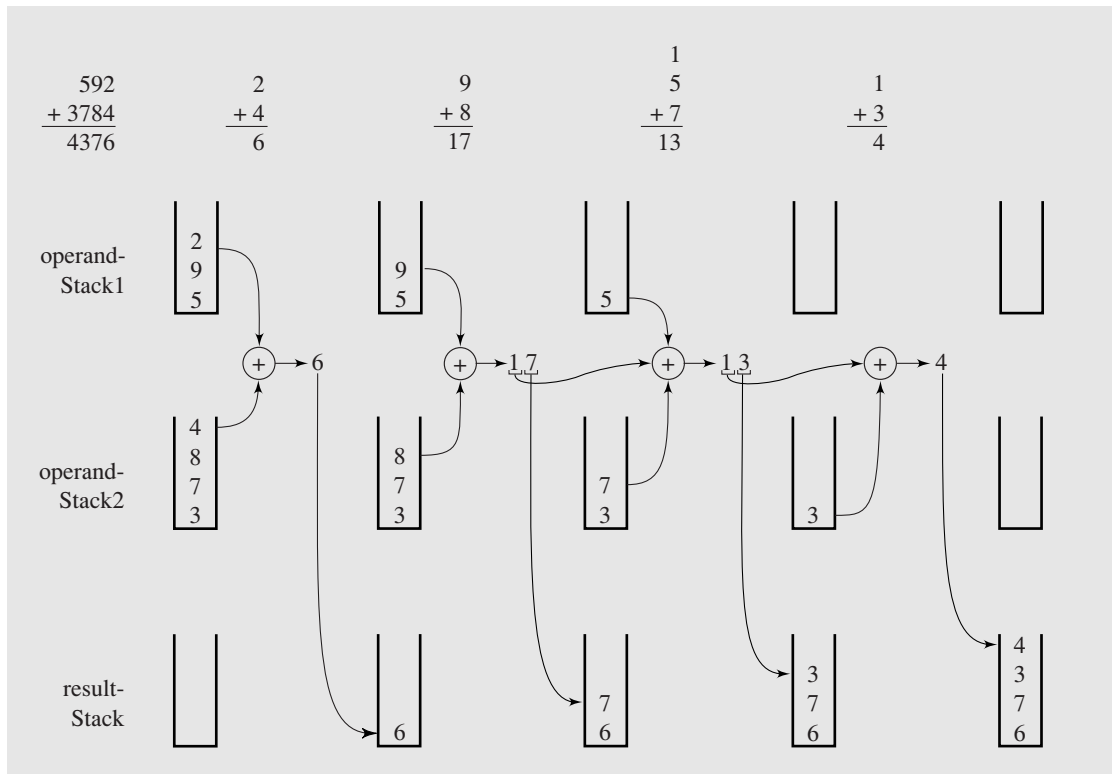
Another important example is a stack used by the Java Virtual Machine (JVM). Java's popularity and power lie in the portability of its programs. This is ensured by compiling Java programs into bytecodes that are executable on a specific machine, the Java Virtual Machine. JVM is distinct in that it has no hardware realization; there is no palpable JVM with a JVM chip. It is an abstract construct; therefore, to execute a Java program, bytecodes have to be interpreted on a particular platform. Thus, in this process, the command

```
javac MyJavaProgram.java
```

transforms each class and interface *C* included in `MyJavaProgram` into bytecodes that are stored in `C.class` file, and then the command

```
java MyClass
```

transforms `MyClass` (that includes `main()`) into machine code executable on a particular computer. In this way, a particular system needs to have an interpreter to execute a stream of bytecodes received through the Internet.

**FIGURE 4.3** An example of adding numbers 592 and 3,784 using stacks.

What is interesting in the context of this chapter is that the JVM is stack based. Each JVM thread has a private *Java stack* that contains *frames* for all currently active methods (only one method in a thread can be currently active; other active methods are suspended). A new frame is pushed every time a new method is invoked, and a frame is popped every time a method completes its execution. Each frame includes an array containing all local variables and an execution environment that includes, among other things, a link to the frame of the caller and information for catching exceptions.

Interestingly, each frame also includes an *operand stack*, which is used by JVM instructions as a source of arguments and a repository of results. For instance, if bytecode 96, which is the instruction `iload`, is followed by a bytecode `index`, which is an index into the array that in the current frame holds local variables, then `iload` loads, or pushes, an integer value from the local variable in position `index` in the array onto the operand stack. Another example is the instruction `imul`, whose bytecode equals 104. If `imul` is encountered, then the two topmost elements, which must be integers, are popped off the operand stack, multiplied, and the integer result is pushed onto the stack. The interpreter is also responsible for passing the final value generated by the current method to the operand stack of its caller.

Consider now implementation of our abstract stack data structure. We used push and pop operations as though they were readily available, but they also have to be implemented as methods operating on the stack.

A natural implementation for a stack is a flexible array. Figure 4.4 contains a generic stack class definition that can be used to store any type of object. Also, a linked list can be used for implementation of a stack (Figure 4.5).

Figure 4.6 shows the same sequence of push and pop operations as Figure 4.1 with the changes that take place in the stack implemented as an array list (Figure 4.6b) and as a linked list (Figure 4.6c). The linked list implementation more closely matches the abstract stack in that it includes only the elements that are on the stack because the

**FIGURE 4.4** Array list implementation of a stack.

```
public class Stack {
    private java.util.ArrayList pool = new java.util.ArrayList();
    public Stack() {
    }
    public Stack(int n) {
        pool.ensureCapacity(n);
    }
    public void clear() {
        pool.clear();
    }
    public boolean isEmpty() {
        return pool.isEmpty();
    }
    public Object topEl() {
        if (isEmpty())
            throw new java.util.EmptyStackException();
        return pool.lastElement();
    }
    public Object pop() {
        if (isEmpty())
            throw new java.util.EmptyStackException();
        return pool.remove(pool.size()-1);
    }
    public void push(Object el) {
        pool.add(el);
    }
    public String toString() {
        return pool.toString();
    }
}
```

**FIGURE 4.5** Implementing a stack as a linked list.

```

public class LLStack {
    private java.util.LinkedList list = new java.util.LinkedList();
    public LLStack() {
    }
    public void clear() {
        list.clear();
    }
    public boolean isEmpty() {
        return list.isEmpty();
    }
    public Object topEl() {
        if (isEmpty())
            throw new java.util.EmptyStackException();
        return list.getLast();
    }
    public Object pop() {
        if (isEmpty())
            throw new java.util.EmptyStackException();
        return list.removeLast();
    }
    public void push(Object el) {
        list.addLast(el);
    }
    public String toString() {
        return list.toString();
    }
}

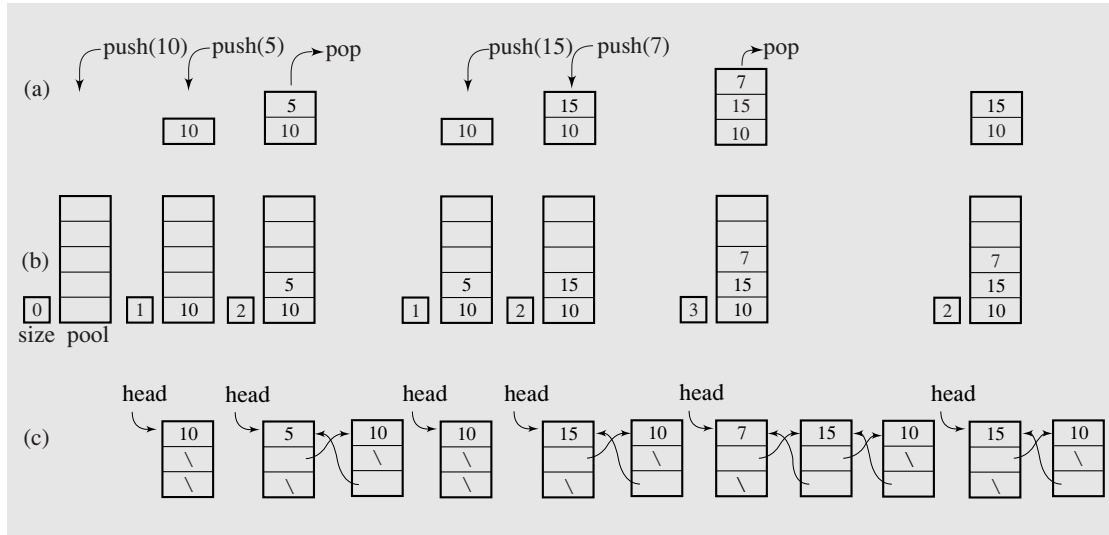
```

number of nodes in the list is the same as the number of stack elements. In the array list implementation, the capacity of the stack can often surpass its size.

The array list implementation, like the linked list implementation, does not force the programmer to make a commitment at the beginning of the program concerning the size of the stack. If the size can be reasonably assessed in advance, then the predicted size can be used as a parameter for the stack constructor to create in advance an array list of the specified capacity. In this way, an overhead is avoided to copy the array list elements to a new larger location when pushing a new element to the stack for which size equals capacity.

It is easy to see that in the array list and linked list implementations, popping and pushing are executed in constant time  $O(1)$ . However, in the array list implementation, pushing an element onto a full stack requires allocating more memory and copies the elements from the existing array list to a new array list. Therefore, in the worst case, pushing takes  $O(n)$  time to finish.

**FIGURE 4.6** A series of operations executed on an abstract stack (a) and the stack implemented with an array (b) and with a linked list (c).



### 4.1.1 Stacks in `java.util`

A generic stack class implemented in the `java.util` package is an extension of class `Vector` to which one constructor and five methods are added (Figure 4.7). A stack can be created with this declaration and initialization:

```
java.util.Stack stack = new java.util.Stack();
```

Note that the return type of `push()` is not `void`, but `Object`: The object being pushed is the return value of the method. To check the topmost element without removing it from the stack, the method `peek()` has to be used. Both `push()` and `peek()` return the original topmost element, not its copy, so that the update of the topmost elements is possible using these methods. Having defined the class `C` with a public double field `d`, the topmost object can be updated as follows:

```
((C)stack.push(new C()).d = 12.3;
((C)stack.peek()).d = 45.6;
```

The Java implementation of the stack is potentially fatal because this is really not a stack, but a structure with stack-related methods. Class `Stack` is simply an extension of class `Vector`; therefore, it inherits all vector-related methods. With the declaration just given, it is possible to have such statements as:

```
stack.setElementAt(new Integer(5), 1);
stack.removeElementAt(3);
```

which violate the integrity of the stack. A stack is a structure in which elements are accessed at one end only, which is not true for the `Stack` class. For this reason, class

**FIGURE 4.7** A list of methods in `java.util.Stack`; all methods from `Vector` are inherited.

Method	Operation
<code>boolean empty()</code>	Return <code>true</code> if the stack includes no element and <code>false</code> otherwise.
<code>Object peek()</code>	Return the top element on the stack; throw <code>EmptyStackException</code> for empty stack.
<code>Object pop()</code>	Remove the top element of the stack and return it; throw <code>EmptyStackException</code> for empty stack.
<code>Object push(Object e1)</code>	Insert <code>e1</code> at the top of the stack and return it.
<code>int search(Object e1)</code>	Return the position of <code>e1</code> on the stack (the first position is at the top; <code>-1</code> in case of failure).
<code>Stack()</code>	Create an empty stack.

`java.util.Stack` is not used in this book. The integrity of the stack could be retained and advantages of vectors utilized if a stack is implemented not as an extension of class `Vector`, but when it uses a vector as a data field, as suggested for an array list field in Figure 4.4.

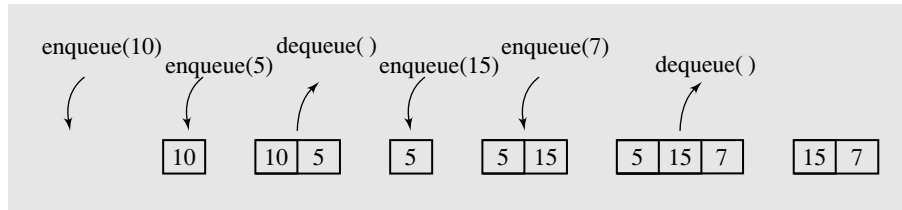
## 4.2 QUEUES

A *queue* is simply a waiting line that grows by adding elements to its end and shrinks by taking elements from its front. Unlike a stack, a queue is a structure in which both ends are used: one for adding new elements and one for removing them. Therefore, the last element has to wait until all elements preceding it on the queue are removed. A queue is an *FIFO* structure: first in/first out.

Queue operations are similar to stack operations. The following operations are needed to properly manage a queue:

- `clear()`—Clear the queue.
- `isEmpty()`—Check to see if the queue is empty.
- `enqueue(e1)`—Put the element `e1` at the end of the queue.
- `dequeue()`—Take the first element from the queue.
- `firstEl()`—Return the first element in the queue without removing it.

A series of enqueue and dequeue operations is shown in Figure 4.8. This time—unlike for stacks—the changes have to be monitored both at the beginning of the queue and at the end. The elements are enqueued on one end and dequeued from the other. For example, after enqueueing 10 and then 5, the dequeue operation removes 10 from the queue (Figure 4.8).

**FIGURE 4.8** A series of operations executed on a queue.

For an application of a queue, consider the following poem written by Lewis Carroll:

Round the wondrous globe I wander wild,  
 Up and down-hill—Age succeeds to youth—  
 Toiling all in vain to find a child  
 Half so loving, half so dear as Ruth.

The poem is dedicated to Ruth Dymes, which is indicated not only by the last word of the poem, but also by reading in sequence the first letter of each line, which also spells Ruth. This type of poem is called an acrostic, and it is characterized by initial letters that form a word or phrase when taken in order. To see whether a poem is an acrostic, we devise a simple algorithm that reads a poem, echoprints it, retrieves and stores the first letter from each line on a queue, and after the poem is processed, all the stored first letters are printed in order. Here is an algorithm:

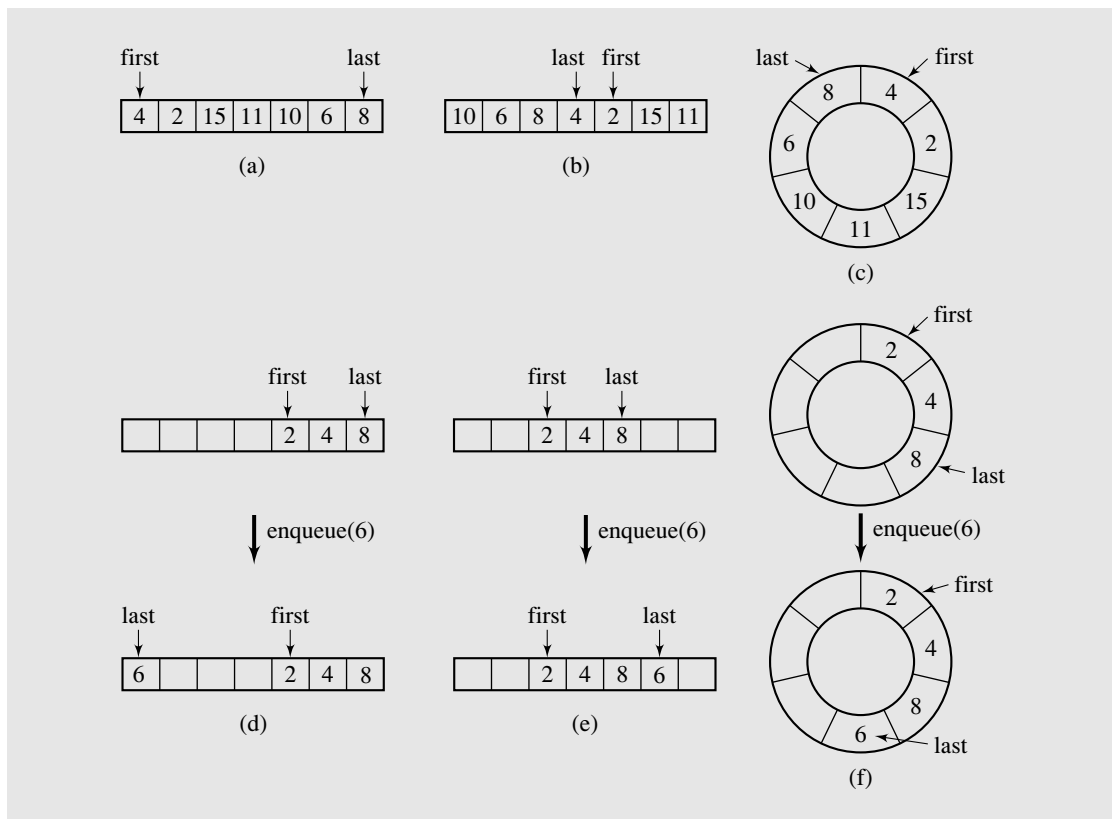
```
acrosticIndicator()
  while not finished
    read a line of poem;
    enqueue the first letter of the line;
    output the line;
  while queue is not empty
    dequeue and print a letter;
```

There is a more significant example to follow, but first consider the problem of implementation.

One possible queue implementation is an array, although this may not be the best choice. Elements are added to the end of the queue, but they may be removed from its beginning, thereby releasing array cells. These cells should not be wasted. Therefore, they are utilized to enqueue new elements, whereby the end of the queue may occur at the beginning of the array. This situation is better pictured as a circular array as Figure 4.9c illustrates. The queue is full if the first element immediately precedes in the counterclockwise direction the last element. However, because a circular array is implemented with a “normal” array, the queue is full if either the first element is in the first cell and the last element is in the last cell (Figure 4.9a) or if the



**FIGURE 4.9** (a–b) Two possible configurations in an array implementation of a queue when the queue is full. (c) The same queue viewed as a circular array. (f) Enqueuing number 6 to a queue storing 2, 4, and 8. (d–e) The same queue seen as a one-dimensional array with the last element (d) at the end of the array and (e) in the middle.



first element is right after the last (Figure 4.9b). Similarly, *enqueue()* and *dequeue()* have to consider the possibility of wrapping around the array when adding or removing elements. For example, *enqueue()* can be viewed as operating on a circular array (Figure 4.9c), but in reality, it is operating on a one-dimensional array. Therefore, if the last element is in the last cell and if any cells are available at the beginning of the array, a new element is placed there (Figure 4.9d). If the last element is in any other position, then the new element is put after the last, space permitting (Figure 4.9e). These two situations must be distinguished when implementing a queue viewed as a circular array (Figure 4.9f).

Figure 4.10 contains possible implementations of methods that operate on queues. A more natural queue implementation is a doubly linked list (Figure 4.11).

**FIGURE 4.10** Array implementation of a queue.

```
public class ArrayQueue {
    private int first, last, size;
    private Object[] storage;
    public ArrayQueue() {
        this(100);
    }
    public ArrayQueue(int n) {
        size = n;
        storage = new Object[size];
        first = last = -1;
    }
    public boolean isFull() {
        return first == 0 && last == size-1 || first == last + 1;
    }
    public boolean isEmpty() {
        return first == -1;
    }
    public void enqueue(Object el) {
        if (last == size-1 || last == -1) {
            storage[0] = el;
            last = 0;
            if (first == -1)
                first = 0;
        }
        else storage[++last] = el;
    }
    public Object dequeue() {
        Object tmp = storage[first];
        if (first == last)
            last = first = -1;
        else if (first == size-1)
            first = 0;
        else first++;
        return tmp;
    }
    public void printAll() {
        for (int i = 0; i < size; i++)
            System.out.print(storage[i] + " ");
    }
}
```

**FIGURE 4.11** Linked list implementation of a queue.

```

public class Queue {
    private java.util.LinkedList list = new java.util.LinkedList();
    public Queue() {
    }
    public void clear() {
        list.clear();
    }
    public boolean isEmpty() {
        return list.isEmpty();
    }
    public Object firstEl() {
        return list.getFirst();
    }
    public Object dequeue() {
        return list.removeFirst();
    }
    public void enqueue(Object el) {
        list.addLast(el);
    }
    public String toString() {
        return list.toString();
    }
}

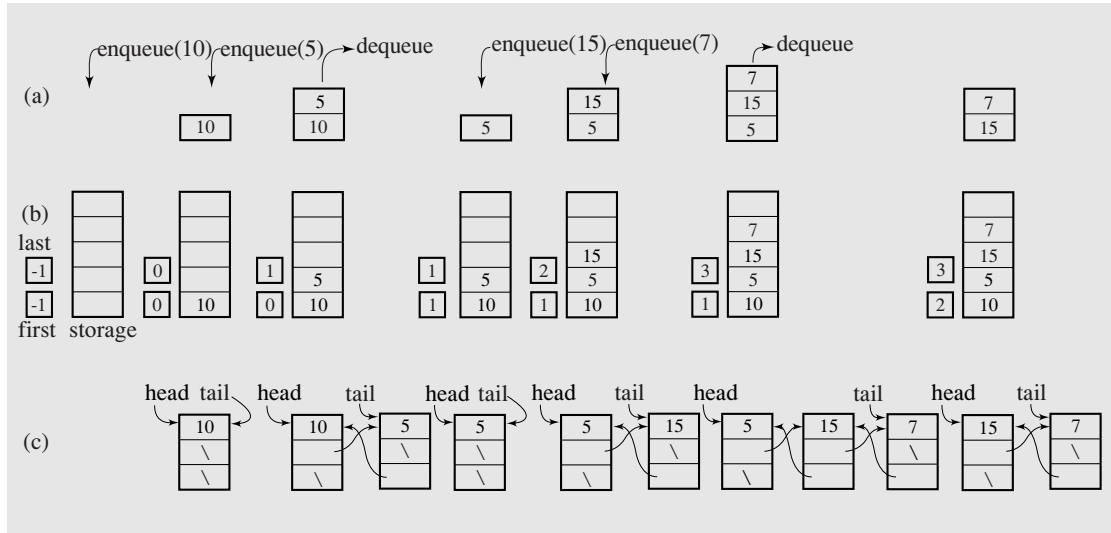
```

In both suggested implementations, enqueueing and dequeueing can be executed in constant time  $O(1)$ . In the doubly linked list implementation, it can be done in  $O(1)$  time.

Figure 4.12 shows the same sequence of enqueue and dequeue operations as Figure 4.8 and indicates the changes in the queue implemented as an array (Figure 4.12b) and as a linked list (Figure 4.12c). The linked list keeps only the numbers that the logic of the queue operations indicated by Figure 4.12a requires. The array includes all the numbers until it fills up, after which new numbers are included starting from the beginning of the array.

Queues are frequently used on simulations to the extent that a well-developed and mathematically sophisticated theory of queues exists, called *queuing theory*, in which various scenarios are analyzed and models are built that use queues. In queuing processes, there are a number of customers coming to servers to receive service. The throughput of the server may be limited. Therefore, customers have to wait in queues before they are served and spend some amount of time while they are being served. By customers, we mean not only people, but also objects. For example, parts on an assembly line in the process of being assembled into a machine, trucks waiting for service at a weighing station on an interstate, or barges waiting for a sluice to be opened so they can

**FIGURE 4.12** A series of operations executed on an abstract queue (a) and the stack implemented with an array (b) and with a linked list (c).



pass through a channel also wait in queues. The most familiar examples are lines in stores, post offices, or banks. The types of problems posed in simulations are: How many servers are needed to avoid long queues? How large must the waiting space be to put the entire queue in it? Is it cheaper to increase this space or to open one more server?

As an example, consider Bank One which, over a period of three months, recorded the number of customers coming to the bank and the amount of time needed to serve them. The table in Figure 4.13a shows the number of customers who arrived during one-minute intervals throughout the day. For 15% of such intervals, no customer arrived, for 20%, only one arrived, and so on. Six clerks were employed, no lines were ever observed, and the bank management wanted to know whether six clerks were too many. Would five suffice? Four? Maybe even three? Can lines be expected at any time? To answer these questions, a simulation program was written that applied the recorded data and checked different scenarios.

The number of customers depends on the value of a randomly generated number between 1 and 100. The table in Figure 4.13a identifies five ranges of numbers from 1 to 100, based on the percentages of one-minute intervals that had 0, 1, 2, 3, or 4 customers. If the random number is 21, then the number of customers is 1; if the random number is 90, then the number of customers is 4. This method simulates the rate of customers arriving at Bank One.

In addition, analysis of the recorded observations indicates that no customer required 10-second or 20-second transactions, 10% required 30 seconds, and so on, as indicated in Figure 4.13b. The table in 4.13b includes ranges for random numbers to generate the length of a transaction in seconds.

**FIGURE 4.13** Bank One example: (a) data for number of arrived customers per one-minute interval and (b) transaction time in seconds per customer.

Number of Customers per Minute	Percentage of One-Minute Intervals	Range	Amount of Time Needed for Service in Seconds	Percentage of Customers	Range
0	15	1–15	0	0	—
1	20	16–35	10	0	—
2	25	36–60	20	0	—
3	10	61–70	30	10	1–10
4	30	71–100	40	5	11–15
	(a)		50	10	16–25
			60	10	26–35
			70	0	—
			80	15	36–50
			90	25	51–75
			100	10	76–85
			110	15	86–100
				(b)	

Figure 4.14 contains the code simulating customer arrival and transaction time at Bank One. The program uses three arrays. `arrivals[]` records the percentages of one-minute intervals depending on the number of the arrived customers. The array `service[]` is used to store the distribution of time needed for service. The amount of time is obtained by multiplying the index of a given array cell by 10. For example, `service[3]` is equal to 10, which means that 10% of the time a customer required  $3 \cdot 10$  seconds for service. The array `clerks[]` records the length of transaction time in seconds.

For each minute (represented by the variable `t`), the number of arriving customers is randomly chosen, and for each customer, the transaction time is also randomly determined. The method `option()` generates a random number, finds the range into which it falls, and then outputs the position, which is either the number of customers or a tenth the number of seconds.

Executions of this program indicate that six and five clerks are too many. With four clerks, service is performed smoothly; 20% of the time there is a short line of waiting customers. However, three clerks are always busy and there is always a long line of customers waiting. Bank management would certainly decide to employ four clerks.

**FIGURE 4.14** Bank One example: implementation code.

```

import java.util.Random;

class BankSimulation {
    static Random rd = new Random();
    static int Option(int percents[]) {
        int i = 0, perc, choice = Math.abs(rd.nextInt()) % 100 + 1;
        for (perc = percents[0]; perc < choice; perc += percents[i+1], i++);
        return i;
    }
    public static void main(String args[]) {
        int[] arrivals = {15,20,25,10,30};
        int[] service = {0,0,0,10,5,10,10,0,15,25,10,15};
        int[] clerks = {0,0,0,0};
        int clerksSize = clerks.length;
        int customers, t, i, numOfMinutes = 100, x;
        double maxWait = 0.0, thereIsLine = 0.0, currWait = 0.0;
        Queue simulQ = new Queue();
        for (t = 1; t <= numOfMinutes; t++) {
            System.out.print(" t = " + t);
            for (i = 0; i < clerksSize; i++) // after each minute subtract
                if (clerks[i] < 60) // at most 60 seconds from time
                    clerks[i] = 0; // left to service the current
                else clerks[i] -= 60; // customer by clerk i;
            customers = Option(arrivals);
            for (i = 0; i < customers; i++) { // enqueue all new customers
                x = Option(service)*10; // (or rather service time
                simulQ.enqueue(new Integer(x)); // they require);
                currWait += x;
            }
            // dequeue customers when clerks are available:
            for (i = 0; i < clerksSize && !simulQ.isEmpty(); )
                if (clerks[i] < 60) {
                    x = ((Integer) simulQ.dequeue()).intValue();
                    // assign more than one customer
                    clerks[i] += x; // to a clerk if service time
                    currWait -= x; // is still below 60 sec;
                }
                else i++;
            if (!simulQ.isEmpty()) {
                thereIsLine++;
                System.out.print(" wait = " + ((long)(currWait/6.0)) / 10.0);
                if (maxWait < currWait)

```

**FIGURE 4.14** (continued)

```

        maxWait = currWait;
    }
    else System.out.print(" wait = 0;");
}
System.out.println("\nFor " + clerksSize + " clerks, there was a line "
    + thereIsLine/numOfMinutes*100.0 + "% of the time;\n"
    + "maximum wait time was " + maxWait/60.0 + " min.");
}
}

```

## 4.3 PRIORITY QUEUES

In many situations, simple queues are inadequate, as when first in/first out scheduling has to be overruled using some priority criteria. In a post office example, a handicapped person may have priority over others. Therefore, when a clerk is available, a handicapped person is served instead of someone from the front of the queue. On roads with tollbooths, some vehicles may be put through immediately, even without paying (police cars, ambulances, fire engines, and the like). In a sequence of processes, process  $P_2$  may need to be executed before process  $P_1$  for the proper functioning of a system, even though  $P_1$  was put on the queue of waiting processes before  $P_2$ . In situations like these, a modified queue, or *priority queue*, is needed. In priority queues, elements are dequeued according to their priority and their current queue position.

The problem with a priority queue is in finding an efficient implementation that allows relatively fast enqueueing and dequeuing. Because elements may arrive randomly to the queue, there is no guarantee that the front elements will be the most likely to be dequeued and that the elements put at the end will be the last candidates for dequeuing. The situation is complicated because a wide spectrum of possible priority criteria can be used in different cases such as frequency of use, birthday, salary, position, status, and others. It can also be the time of scheduled execution on the queue of processes, which explains the convention used in priority queue discussions in which higher priorities are associated with lower numbers indicating priority.

Priority queues can be represented by two variations of linked lists. In one type of linked list, all elements are entry ordered, and in another, order is maintained by putting a new element in its proper position according to its priority. In both cases, the total operational times are  $O(n)$  because, for an unordered list, adding an element is immediate but searching is  $O(n)$ , and in a sorted list, taking an element is immediate but adding an element is  $O(n)$ .

Another queue representation uses a short ordered list and an unordered list, and a threshold priority is determined (Blackstone et al., 1981). The number of elements in

the sorted list depends on a threshold priority. This means that in some cases this list can be empty and the threshold may change dynamically to have some elements in this list. Another way is always having the same number of elements in the sorted list; the number  $\sqrt{n}$  is a good candidate. Enqueuing takes on the average  $O(\sqrt{n})$  time and dequeuing is immediate.

Another implementation of queues was proposed by J. O. Hendriksen (1977, 1983). It uses a simple linked list with an additional array of references to this list to find a range of elements in the list in which a newly arrived element should be included.

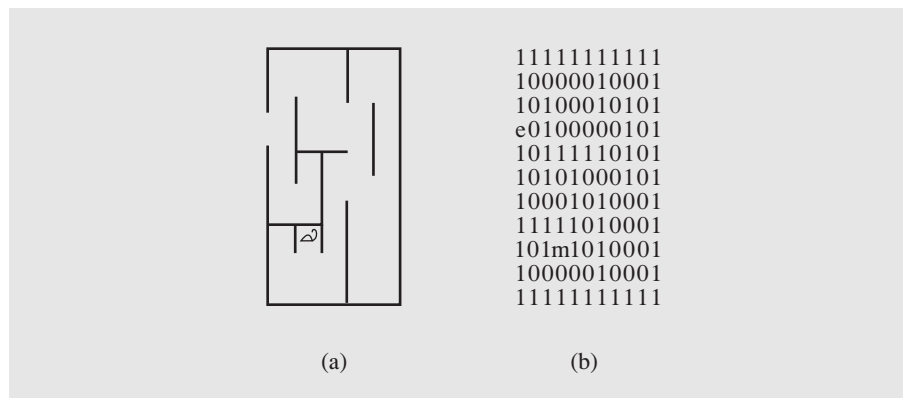
Experiments by Douglas W. Jones (1986) indicate that a linked list implementation, in spite of its  $O(n)$  efficiency, is best for 10 elements or less. The efficiency of the two-list version depends greatly on the distribution of priorities, and it may be excellent or as poor as that of the simple list implementation for large numbers of elements. Hendriksen's implementation, with its  $O(\sqrt{n})$  complexity, operates consistently well with queues of any size.

## 4.4 CASE STUDY: EXITING A MAZE

Consider the problem of a trapped mouse that tries to find its way to an exit in a maze (Figure 4.15a). The mouse hopes to escape from the maze by systematically trying all the routes. If it reaches a dead end, it retraces its steps to the last position and begins at least one more untried path. For each position, the mouse can go in one of four directions: right, left, down, up. Regardless of how close it is to the exit, it always tries the open paths in this order, which may lead to some unnecessary detours. By retaining information that allows for resuming the search after a dead end is reached, the mouse uses a method called *backtracking*. This method is discussed further in the next chapter.

The maze is implemented as a two-dimensional character array in which passages are marked with 0s, walls by 1s, exit position by the letter e, and the initial posi-

**FIGURE 4.15** (a) A mouse in a maze; (b) two-dimensional character array representing this situation.





tion of the mouse by the letter m (Figure 4.15b). In this program, the maze problem is slightly generalized by allowing the exit to be in any position of the maze (picture the exit position as having an elevator that takes the mouse out of the trap) and allowing passages to be on the borderline. To protect itself from falling off the array by trying to continue its path when an open cell is reached on one of the borderlines, the mouse also has to constantly check whether it is in such a borderline position or not. To avoid it, the program automatically puts a frame of 1s around the maze entered by the user.

The program uses two stacks: one to initialize the maze and another to implement backtracking.

The user enters a maze one line at a time. The maze entered by the user can have any number of rows and any number of columns. The only assumption the program makes is that all rows are of the same lengths and that it uses only these characters: any number of 1s, any number of 0s, one e, and one m. The rows are pushed on the stack `mazeRows` in the order they are entered after attaching one 1 at the beginning and one 1 at the end. After all rows are entered, the size of the array store can be determined, and then the rows from the stack are transferred to the array.

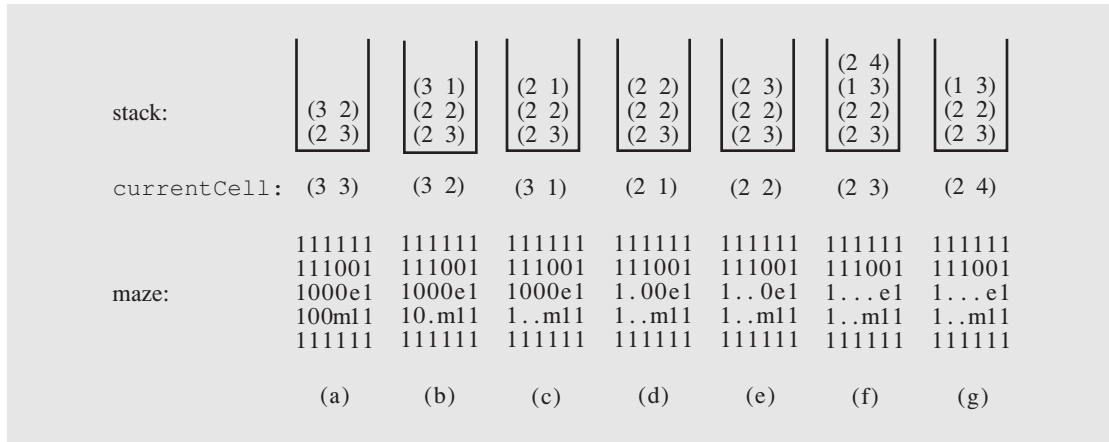
A second stack, `mazeStack`, is used in the process of escaping the maze. To remember untried paths for subsequent tries, the positions of the untried neighbors of the current position (if any) are stored on a stack and always in the same order, first upper neighbor, then lower, then left, and finally right. After stacking the open avenues on the stack, the mouse takes the topmost position and tries to follow it by first storing untried neighbors and then trying the topmost position and so forth, until it reaches the exit or exhausts all possibilities and finds itself trapped. To avoid falling into an infinite loop of trying paths that have already been investigated, each visited position of the maze is marked with a period.

Here is a pseudocode of an algorithm for escaping a maze:

```
exitMaze()
  initialize stack, exitCell, entryCell, currentCell = entryCell;
  while currentCell is not exitCell
    mark currentCell as visited;
    push onto the stack the unvisited neighbors of currentCell;
    if stack is empty
      failure;
    else pop off a cell from the stack and make it currentCell;
  success;
```

The stack stores coordinates of positions of cells. This could be done, for instance, by using two integer stacks for *x* and *y* coordinates. Another possibility is to use one integer stack with both coordinates stored in one integer variable with the help of the shifting operation. In the program in Figure 4.17, a class `MazeCell` is used with two data fields, *x* and *y*, so that one `mazeStack` is used for storing `MazeCell` objects.

Consider an example shown in Figure 4.16. The program actually prints out the maze after each step made by the mouse.

**FIGURE 4.16** An example of processing a maze.**0.** After the user enters the maze

```
1100
000e
00m1
```

the maze is immediately surrounded with a frame of 1s

```
111111
111001
1000e1
100m11
111111
```

`entryCell` and `currentCell` are initialized to (3 3) and `exitCell` to (2 4) (Figure 4.16a).

1. Because `currentCell` is not equal to `exitCell`, all four neighbors of the current cell (3 3) are tested, and only two of them are candidates for processing, namely, (3 2) and (2 3); therefore, they are pushed onto the stack. The stack is checked to see whether it contains any position, and because it is not empty, the topmost position (3 2) becomes current (Figure 4.16b).
2. `currentCell` is still to equal to `exitCell`; therefore, the two viable options accessible from (3 2) are pushed onto the stack, namely, positions (2 2) and (3 1). Note that the position holding the mouse is not included in the stack. After the current position is marked as visited, the situation in the maze is as in Figure 4.16c. Now, the topmost position, (3 1), is popped off the stack, and it becomes the value of `currentCell`. The process continues until the exit is reached, as shown step by step in Figure 4.16d–f.

Note that in step four (Figure 4.16d), the position (2 2) is pushed onto the stack, although it is already there. However, this poses no danger, because when the second instance of this position is popped from the stack, all the paths leading from this position have already been investigated using the first instance of this position on the stack. Note also that the mouse makes a detour, although there is a shorter path from its initial position to the exit.

Figure 4.17 contains code implementing the maze exiting algorithm. The program uses the stack defined in this chapter. If the user wants to use the stack from `java.util`, the line

**FIGURE 4.17** Listing of the program for maze processing.

```
//***** Maze.java *****
import java.io.*;

class MazeCell {
    public int x, y;
    public MazeCell() {
    }
    public MazeCell(int i, int j) {
        x = i; y = j;
    }
    public boolean equals(MazeCell cell) {
        return x == cell.x && y == cell.y;
    }
}

class Maze {
    private int rows = 0, cols = 0;
    private char[][] store;
    private MazeCell currentCell, exitCell = new MazeCell(), entryCell = new
    MazeCell();
    private final char exitMarker = 'e', entryMarker = 'm', visited = '.';
    private final char passage = '0', wall = '1';
    private Stack mazeStack = new Stack();
    public Maze() {
        int row = 0, col = 0;
        Stack mazeRows = new Stack();
        InputStreamReader isr = new InputStreamReader(System.in);
        BufferedReader buffer = new BufferedReader(isr);
        System.out.println("Enter a rectangular maze using the following "
            + "characters:\nm - entry\n e - exit\nl - wall\n0 - passage\n"
            + "Enter one line at a time; end with Ctrl-z:");
    }
}
```

*Continues*

**FIGURE 4.17** (continued)

```

try {
    String str = buffer.readLine();
    while (str != null) {
        row++;
        cols = str.length();
        str = "1" + str + "1"; // put 1s in the borderline cells;
        mazeRows.push(str);
        if (str.indexOf(exitMarker) != -1) {
            exitCell.x = row;
            exitCell.y = str.indexOf(exitMarker);
        }
        if (str.indexOf(entryMarker) != -1) {
            entryCell.x = row;
            entryCell.y = str.indexOf(entryMarker);
        }
        str = buffer.readLine();
    }
} catch(IOException eof) {
}

rows = row;
store = new char[rows+2][]; // create a 1D array of char arrays;
store[0] = new char[cols+2]; // a borderline row;
for ( ; !mazeRows.isEmpty(); row--)
    store[row] = ((String) mazeRows.pop()).toCharArray();
store[rows+1] = new char[cols+2]; // another borderline row;
for (col = 0; col <= cols+1; col++) {
    store[0][col] = wall; // fill the borderline rows with 1s;
    store[rows+1][col] = wall;
}
}

private void display(PrintStream out) {
    for (int row = 0; row <= rows+1; row++)
        out.println(store[row]);
    out.println();
}

private void pushUnvisited(int row, int col) {
    if (store[row][col] == passage || store[row][col] == exitMarker)
        mazeStack.push(new MazeCell(row,col));
}

public void exitMaze(PrintStream out) {
    currentCell = entryCell;
    out.println();
}

```

**FIGURE 4.17** (continued)

```

while (!currentCell.equals(exitCell)) {
    int row = currentCell.x;
    int col = currentCell.y;
    display(System.out);          // print a snapshot;
    if (!currentCell.equals(entryCell))
        store[row][col] = visited;
    pushUnvisited(row-1,col);
    pushUnvisited(row+1,col);
    pushUnvisited(row,col-1);
    pushUnvisited(row,col+1);
    if (mazeStack.isEmpty()) {
        display(out);
        out.println("Failure");
        return;
    }
    else currentCell = (MazeCell) mazeStack.pop();
}
display(out);
out.println("Success");
}
static public void main (String args[]) {
    (new Maze()).exitMaze(System.out);
}
}

```

```
Stack stack = new Stack();
```

should be replaced by

```
java.util.Stack stack = new java.util.Stack();
```

No other changes need to be made, although according to Figure 4.7, `java.util.Stack()` uses method `empty()`, but the program in Figure 4.17 uses method `isEmpty()`. This occurs because the method `isEmpty()` is inherited by `java.util.Stack()` from `java.util.Vector()`.

## 4.5

## EXERCISES

1. Reverse the order of elements on stack  $S$ 
  - a. using two additional stacks
  - b. using one additional queue
  - c. using one additional stack and some additional non-array variables
2. Put the elements on the stack  $S$  in ascending order using one additional stack and some additional non-array variables.
3. Transfer elements from stack  $S_1$  to stack  $S_2$  so that the elements from  $S_2$  are in the same order as on  $S_1$ 
  - a. using one additional stack
  - b. using no additional stack but only some additional non-array variables
4. A possible definition of a linked list–based stack can be given as follows:

```
public class LLStack2 extends LinkedList {
    public Object pop() {
        return removeLast();
    }
    public void push(Object e1) {
        add(e1);
    }
    . . . . .
}
```

It appears to be simpler than the definition of `LLStack` in Figure 4.5. What is the problem with the definition of `LLStack2`?

5. Using additional non-array variables, order all elements on a queue using also
  - a. two additional queues
  - b. one additional queue
6. In this chapter, two different implementations were developed for a stack: class `Stack` and class `LLStack`. The names of methods in both classes suggest that the same data structure is meant; however, a tighter connection between these two classes can be established. Define an abstract base class for a stack and derive from it both class `Stack` and class `LLStack`.

7. Define a stack in terms of a queue; that is, create a class

```
class StackQ {
    Queue pool = new Queue();
    . . . . .
    public void push(Object e1) {
        pool.enqueue(e1);
        . . . . .
    }
}
```

8. Define a queue in terms of a stack.  
9. A generic queue class defined in terms of an array list:

```
public class QueueV
    private java.util.ArrayList list = new java.util.ArrayList();
    public Object dequeue() {
        . . . . .
    }
}
```

Is this a viable solution?

10. Modify the program from the case study to print out the path without dead ends and, possibly, with detours. For example, for an input maze

```
1111111
1e00001
1110111
1000001
100m001
1111111
```

the program from the case study outputs the processed maze

```
1111111
1e....1
111.111
1.....1
1..m..1
1111111
Success
```

The modified program should, in addition, generate the path from the exit to the mouse:

```
[1 1] [1 2] [1 3] [2 3] [3 3] [3 4] [3 5] [4 5] [4 4] [4 3]
```

which leaves out two dead ends, [1 4] [1 5] and [3 2] [3 1] [4 1] [4 2], but retains a detour, [3 4] [3 5] [4 5] [4 4].

11. Modify the program from the previous exercise so that it prints the maze with the path without dead ends; the path is indicated by dashes and vertical bars to show the changes of direction of the path; for the input maze from the previous exercise, the modified program should output

```
1111111
1e--. .1
111|111
1..|--1
1..m-|1
1111111
```

## 4.6

## PROGRAMMING ASSIGNMENTS

1. Write a program that determines whether an input string is a palindrome; that is, whether it can be read the same way forward and backward. At each point, you can read only one character of the input string; do not use an array to first store this string and then analyze it (except, possibly, in a stack implementation). Consider using multiple stacks.
2. Write a program to convert a number from decimal notation to a number expressed in a number system whose base (or radix) is a number between 2 and 9. The conversion is performed by repetitious division by the base to which a number is being converted and then taking the remainders of division in the reverse order. For example, in converting to binary, number 6 requires three such divisions:  $6/2 = 3$  remainder 0,  $3/2 = 1$  remainder 1, and finally,  $1/2 = 0$  remainder 1. The remainders 0, 1, and 1 are put in the reverse order so that the binary equivalent of 6 is equal to 110.

Modify your program so that it can perform a conversion in the case when the base is a number between 11 and 27. Number systems with bases greater than 10 require more symbols. Therefore, use capital letters. For example, a hexadecimal system requires 16 digits: 0, 1, . . . , 9, A, B, C, D, E, F. In this system, decimal number 26 is equal to 1A in hexadecimal notation, because  $26/16 = 1$  remainder 10 (that is, A), and  $1/16 = 0$  remainder 1.

3. Write a program that implements the algorithm `delimiterMatching()` from Section 4.1.
4. Write a program that implements the algorithm `addingLargeNumbers()` from Section 4.1.
5. Write a program to add any number of large integers. The problem can be approached in at least two ways.
  - a. First, add two numbers and then repeatedly add the next number with the result of the previous addition.
  - b. Create a vector of stacks and then use a generalized version of `addingLargeNumbers()` to all stacks at the same time.



6. Write a program to perform the four basic arithmetic operations,  $+$ ,  $-$ ,  $\cdot$ , and  $/$ , on very large integers; the result of division should also be an integer. Apply these operations to compute  $123^{45}$ , or the hundredth number in the sequence  $1 * 2 + 3, 2 * 3^2 + 4, 3 * 4^3 + 5, \dots$ . Also apply them to compute the Gödel numbers of arithmetic expressions.

The Gödel numbering function  $GN$  first establishes a correspondence between basic elements of language and numbers:

Symbol	Gödel Number $GN$
=	1
+	2
*	3
-	4
/	5
(	6
)	7
^	8
0	9
S	10
$x_i$	$11 + 2 * i$
$X_i$	$12 + 2 * i$

where  $S$  is the successor function. Then, for any formula  $F = s_1 s_2 \dots s_n$ :

$$GN('s_1 s_2 \dots s_n') = 2^{GN(s_1)} * 3^{GN(s_2)} * \dots * p_n^{GN(s_n)}$$

where  $p_n$  is the  $n$ th prime. For example,

$$GN(1) = GN(S0) = 2^{10} * 3^9$$

and

$$GN('x_1 + x_3 = x_4') = 2^{11+2} * 3^2 * 5^{11+6} * 7^1 * 11^{11+8}$$

In this way, every arithmetic expression can be assigned a unique number. This method has been used by Gödel to prove theorems, known as Gödel's theorems, which are of extreme importance for the foundations of mathematics.

7. Write a program for adding very large floating-point numbers. Extend this program to other arithmetic operations.

 **BIBLIOGRAPHY*****Queues***

Sloyer, Clifford, Copes, Wayne, Sacco, William, and Starck, Robert, *Queues: Will This Wait Never End!* Providence, RI: Janson, 1987.

***Priority Queues***

Blackstone, John H., Hogg, Gary L., and Phillips, Don T., “A Two-List Synchronization Procedure for Discrete Event Simulation,” *Communications of the ACM* 24 (1981), 825–829.

Hendriksen, James O., “An Improved Events List Algorithm,” *Proceedings of the 1977 Winter Simulation Conference*, Piscataway, NJ: IEEE, 1977, 547–557.

Hendriksen, James O., “Event List Management—A Tutorial,” *Proceedings of the 1983 Winter Simulation Conference*, Piscataway, NJ: IEEE, 1983, 543–551.

Jones, Douglas W., “An Empirical Comparison of Priority-Queue and Event-Set Implementations,” *Communications of the ACM* 29 (1986), 300–311.

***Java Virtual Machine***

Joshi, Daniel I., Lemay, Laura, and Perkins, Charles L., *Teach Yourself Java in Café in 21 Days*, Indianapolis, IN: Sams.net Publishing, 1996, Ch. 21.

Lindholm, Tim, and Yellin, Frank, *The Java Virtual Machine Specification*, Reading, MA: Addison-Wesley, 1999.

Meyer, Jon, and Downing, Troy, *Java Virtual Machine*, Cambridge, MA: O’Reilly, 1997.

# Recursion



## 5.1 RECURSIVE DEFINITIONS

One of the basic rules for defining new objects or concepts is that the definition should contain only such terms that have already been defined or that are obvious. Therefore, an object that is defined in terms of itself is a serious violation of this rule—a vicious circle. On the other hand, there are many programming concepts that define themselves. As it turns out, formal restrictions imposed on definitions such as existence and uniqueness are satisfied and no violation of the rules takes place. Such definitions are called *recursive definitions*, and are used primarily to define infinite sets. When defining such a set, giving a complete list of elements is impossible, and for large finite sets, it is inefficient. Thus, a more efficient way has to be devised to determine if an object belongs to a set.

A recursive definition consists of two parts. In the first part, called the *anchor* or the *ground case*, the basic elements that are the building blocks of all other elements of the set are listed. In the second part, rules are given that allow for the construction of new objects out of basic elements or objects that have already been constructed. These rules are applied again and again to generate new objects. For example, to construct the set of natural numbers, one basic element, 0, is singled out, and the operation of incrementing by 1 is given as:

1.  $0 \in \mathbf{N}$ ;
2. if  $n \in \mathbf{N}$ , then  $(n + 1) \in \mathbf{N}$ ;
3. there are no other objects in the set  $\mathbf{N}$ .

(More axioms are needed to ensure that only the set that we know as the natural numbers can be constructed by these rules.)

According to these rules, the set of natural numbers  $\mathbf{N}$  consists of the following items: 0,  $0 + 1$ ,  $0 + 1 + 1$ ,  $0 + 1 + 1 + 1$ , and so on. Although the set  $\mathbf{N}$  contains objects (and only such objects) that we call natural numbers, the definition results in a somewhat unwieldy list of elements. Can you imagine doing arithmetic on large numbers

using such a specification? Therefore, it is more convenient to use the following definition, which encompasses the whole range of Arabic numeric heritage:

1.  $0, 1, 2, 3, 4, 5, 6, 7, 8, 9 \in \mathbf{N}$ ;
2. if  $n \in \mathbf{N}$ , then  $n0, n1, n2, n3, n4, n5, n6, n7, n8, n9 \in \mathbf{N}$ ;
3. these are the only natural numbers.

Then the set  $\mathbf{N}$  includes all possible combinations of the basic building blocks 0 through 9.

Recursive definitions serve two purposes: *generating* new elements, as already indicated, and *testing* whether an element belongs to a set. In the case of testing, the problem is solved by reducing it to a simpler problem, and if the simpler problem is still too complex it is reduced to an even simpler problem, and so on, until it is reduced to a problem indicated in the anchor. For instance, is 123 a natural number? According to the second condition of the definition introducing the set  $\mathbf{N}$ ,  $123 \in \mathbf{N}$  if  $12 \in \mathbf{N}$  and the first condition already says that  $3 \in \mathbf{N}$ ; but  $12 \in \mathbf{N}$  if  $1 \in \mathbf{N}$  and  $2 \in \mathbf{N}$ , and they both belong to  $\mathbf{N}$ .

The ability to decompose a problem into simpler subproblems of the same kind is sometimes a real blessing, as we shall see in the discussion of quicksort in Section 9.3.3, or a curse, as we shall see shortly in this chapter.

Recursive definitions are frequently used to define functions and sequences of numbers. For instance, the factorial function,  $!$ , can be defined in the following manner:

$$n! = \begin{cases} 1 & \text{if } n = 0 \text{ (anchor)} \\ n \cdot (n-1)! & \text{if } n > 0 \text{ (inductive step)} \end{cases}$$

Using this definition, we can generate the sequence of numbers

$$1, 1, 2, 6, 24, 120, 720, 5040, 40320, 362880, 3628800, \dots$$

which includes the factorials of the numbers  $0, 1, 2, \dots, 10, \dots$

Another example is the definition

$$f(n) = \begin{cases} 1 & \text{if } n = 0 \\ f(n-1) + \frac{1}{f(n-1)} & \text{if } n > 0 \end{cases}$$

which generates the sequence of rational numbers

$$1, 2, \frac{5}{2}, \frac{29}{10}, \frac{941}{290}, \frac{969581}{272890}, \dots$$

Recursive definitions of sequences have one undesirable feature: To determine the value of an element  $s_n$  of a sequence, we first have to compute the values of some or all of the previous elements,  $s_1, \dots, s_{n-1}$ . For example, calculating the value of  $3!$  requires us to first compute the values of  $0!$ ,  $1!$ , and  $2!$ . Computationally, this is undesirable because it forces us to make calculations in a roundabout way. Therefore, we want to

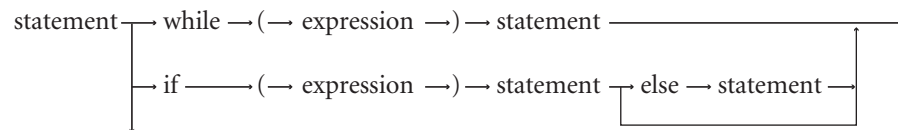
find an equivalent definition or formula that makes no references to other elements of the sequence. Generally, finding such a formula is a difficult problem that cannot always be solved. But the formula is preferable to a recursive definition because it simplifies the computational process and allows us to find the answer for an integer  $n$  without computing the values for integers  $0, 1, \dots, n - 1$ . For example, a definition of the sequence  $g$ ,

$$g(n) = \begin{cases} 1 & \text{if } n = 0 \\ 2 \cdot g(n-1) & \text{if } n > 0 \end{cases}$$

can be converted into the simple formula

$$g(n) = 2^n$$

In the foregoing discussion, recursive definitions have been dealt with only theoretically, as a definition used in mathematics. Naturally, our interest is in computer science. One area where recursive definitions are used extensively is in the specification of the grammars of programming languages. Every programming language manual contains—either as an appendix or throughout the text—a specification of all valid language elements. Grammar is specified either in terms of block diagrams or in terms of the Backus-Naur form (BNF). For example, the syntactic definition of a statement in the Java language can be presented in the block diagram form:



or in BNF:

```
<statement> ::= while (<expression>) <statement> |
               if (<expression>) <statement> |
               if (<expression>) <statement>else<statement> |
               ...
```

The language element  $\langle \text{statement} \rangle$  is defined recursively, in terms of itself. Such definitions naturally express the possibility of creating such syntactic constructs as nested statements or expressions.

Recursive definitions are also used in programming. The good news is that virtually no effort is needed to make the transition from a recursive definition of a function to its implementation in Java. We simply make a translation from the formal definition into Java syntax. Hence, for example, a Java equivalent of factorial is the method

```
int factorial (int n) {
    if (n == 0)
        return 1;
    else return n * factorial (n - 1);
}
```

The problem now seems to be more critical because it is far from clear how a method calling itself can possibly work, let alone return the correct result. This chapter shows that it is possible for such a method to work properly. Recursive definitions on most computers are eventually implemented using a run-time stack, although the whole work of implementing recursion is done by the operating system, and the source code includes no indication of how it is performed. E. W. Dijkstra introduced the idea of using a stack to implement recursion. To better understand recursion and to see how it works, it is necessary to discuss the processing of method calls and to look at operations carried out by the system at method invocation and method exit.

## 5.2

### METHOD CALLS AND RECURSION IMPLEMENTATION

What happens when a method is called? If the method has formal parameters, they have to be initialized to the values passed as actual parameters. In addition, the system has to know where to resume execution of the program after the method has finished. The method can be called by other methods or by the main program (the method `main()`). The information indicating where it has been called from has to be remembered by the system. This could be done by storing the return address in main memory in a place set aside for return addresses, but we do not know in advance how much space might be needed, and allocating too much space for that purpose alone is not efficient.

For a method call, more information has to be stored than just a return address. Therefore, dynamic allocation using the run-time stack is a much better solution. It needs to be stressed that the run-time stack is maintained by a particular operating system. At the end of Section 4.1, a Java stack used by the Java Virtual Machine was briefly described. Java stack and run-time stack are two different entities. They are similar in that their role in processing method calls is basically the same; therefore, they store similar information that enables this processing, although they store this information differently. The role of the interpreter `java` is to convert information bytecodes in `.class` files so that the run-time stack takes over the function of the Java stack, which is only an abstract construct. The subsequent discussion is presented in terms of the run-time stack rather than the Java stack, which in no way changes the logic of processing method calls, in particular, recursive calls.

What information should be preserved when a method is called? First, automatic (local) variables must be stored. If method `f1()`, which contains a declaration of an automatic variable `x`, calls method `f2()`, which locally declares the variable `x`, the system has to make a distinction between these two variables `x`. If `f2()` uses a variable `x`, then its own `x` is meant; if `f2()` assigns a value to `x`, then `x` belonging to `f1()` should be left unchanged. When `f2()` is finished, `f1()` can use the value assigned to its private `x` before `f2()` was called. This is especially important in the context of the present chapter, when `f1()` is the same as `f2()`, when a

method calls itself recursively. How does the system make a distinction between these two variables `x`?

The state of each method, including `main()`, is characterized by the contents of all automatic variables, by the values of the method's parameters, and by the return address indicating where to restart its caller. The data area containing all this information is called an *activation record* or a *stack frame* and is allocated on the run-time stack. An activation record exists for as long as a method owning it is executing. This record is a private pool of information for the method, a repository that stores all information necessary for its proper execution and how to return to where it was called from. Activation records usually have a short lifespan because they are dynamically allocated at method entry and deallocated upon exiting. Only the activation record of `main()` outlives every other activation record.

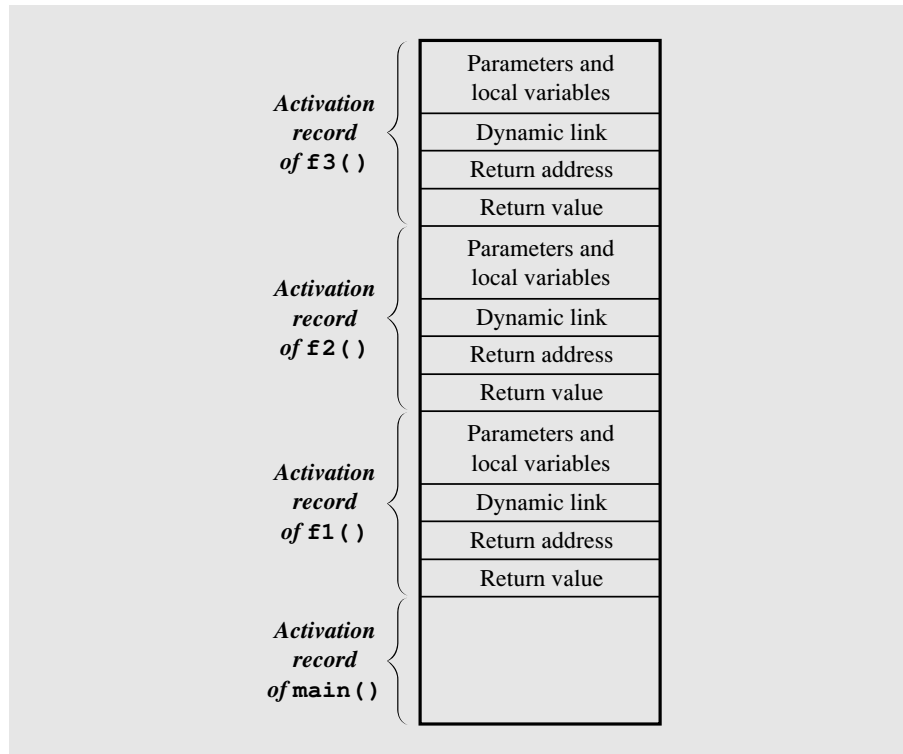
An activation record usually contains the following information:

- Values for all parameters to the method, location of the first cell if an array is passed or a variable is passed by reference, and copies of all other data items.
- Local (automatic) variables that can be stored elsewhere, in which case, the activation record contains only their descriptors and pointers to the locations where they are stored.
- The return address to resume control by the caller, the address of the caller's instruction immediately following the call.
- A dynamic link, which is a pointer to the caller's activation record.
- The returned value for a method not declared as `void`. Because the size of the activation record may vary from one call to another, the returned value is placed right above the activation record of the caller.

As mentioned, if a method is called either by `main()` or by another method, then its activation record is created on the run-time stack. The run-time stack always reflects the current state of the method. For example, suppose that `main()` calls method `f1()`, `f1()` calls `f2()`, and `f2()` in turn calls `f3()`. If `f3()` is being executed, then the state of the run-time stack is as shown in Figure 5.1. By the nature of the stack, if the activation record for `f3()` is popped by moving the stack pointer right below the return value of `f3()`, then `f2()` resumes execution and now has free access to the private pool of information necessary for reactivation of its execution. On the other hand, if `f3()` happens to call another method `f4()`, then the run-time stack increases its height because the activation record for `f4()` is created on the stack and the activity of `f3()` is suspended.

Creating an activation record whenever a method is called allows the system to handle recursion properly. Recursion is calling a method that happens to have the same name as the caller. Therefore, a recursive call is not literally a method calling itself, but rather an instantiation of a method calling another instantiation of the same original. These invocations are represented internally by different activation records and are thus differentiated by the system.

**FIGURE 5.1** Contents of the run-time stack when `main()` calls method `f1()`, `f1()` calls `f2()`, and `f2()` calls `f3()`.



### 5.3 ANATOMY OF A RECURSIVE CALL

The function that defines raising any number  $x$  to a nonnegative integer power  $n$  is a good example of a recursive function. The most natural definition of this function is given by:

$$x^n = \begin{cases} 1 & \text{if } n = 0 \\ x \cdot x^{n-1} & \text{if } n > 0 \end{cases}$$

A Java method for computing  $x^n$  can be written directly from the definition of a power:

```

/* 102 */ double power (double x, int n) {
/* 103 */     if (n == 0)
/* 104 */         return 1.0;
// else
/* 105 */         return x * power(x,n-1);
}

```



What if we called the method with a negative  $n$ ? To avoid this problem, we can add another test in the method, such as `if (n < 0)`, and return a special value, say,  $-1$ , or print an error message, or we can make sure before `power()` is called that  $n \geq 0$ .

Using this definition, the value of  $x^4$  can be computed in the following way:

$$\begin{aligned} x^4 &= x \cdot x^3 = x \cdot (x \cdot x^2) = x \cdot (x \cdot (x \cdot x^1)) = x \cdot (x \cdot (x \cdot (x \cdot x^0))) \\ &= x \cdot (x \cdot (x \cdot (x \cdot 1))) = x \cdot (x \cdot (x \cdot (x))) = x \cdot (x \cdot (x \cdot x)) \\ &= x \cdot (x \cdot x \cdot x) = x \cdot x \cdot x \cdot x \end{aligned}$$

The repetitive application of the inductive step eventually leads to the anchor, which is the last step in the chain of recursive calls. The anchor produces 1 as a result of raising  $x$  to the power of zero; the result is passed back to the previous recursive call. Now, that call, whose execution has been pending, returns its result,  $x \cdot 1 = x$ . The third call, which has been waiting for this result, computes its own result, namely,  $x \cdot x$ , and returns it. Next, this number  $x \cdot x$  is received by the second call, which multiplies it by  $x$  and returns the result,  $x \cdot x \cdot x$ , to the first invocation of `power()`. This call receives  $x \cdot x \cdot x$ , multiplies it by  $x$ , and returns the final result. In this way, each new call increases the level of recursion, as follows:

call 1	$x^4 = x \cdot x^3$	$= x \cdot x \cdot x \cdot x$
call 2	$x \cdot x^2$	$= x \cdot x \cdot x$
call 3	$x \cdot x^1$	$= x \cdot x$
call 4	$x \cdot x^0$	$= x \cdot 1 = x$
call 5		1

or alternatively, as

call 1	<code>power(x, 4)</code>
call 2	<code>power(x, 3)</code>
call 3	<code>power(x, 2)</code>
call 4	<code>power(x, 1)</code>
call 5	<code>power(x, 0)</code>
call 5	1
call 4	$x$
call 3	$x \cdot x$
call 2	$x \cdot x \cdot x$
call 1	$x \cdot x \cdot x \cdot x$

What does the system do as the method is being executed? As we already know, the system keeps track of all calls on its run-time stack. Each line of code is assigned a number by the system,<sup>1</sup> and if a line is a method call, then its number is a return address. The address is used by the system to remember where to resume execution after the method has completed. For this example, assume that the lines in the method

<sup>1</sup>This is not quite precise because the system uses machine code rather than source code to execute programs. This means that one line of source program is usually implemented by several machine instructions.

`power()` are assigned the numbers 102 through 105 and that it is called `inmain()` from the statement

```

        static public void main(String args[] ) {
            { ...
/* 136 */  y = power(5.6,2);
            ...
        }

```

A trace of the recursive calls is relatively simple, as indicated by this diagram

call 1	<code>power(5.6,2)</code>
call 2	<code>power(5.6,1)</code>
call 3	<code>power(5.6,0)</code>
call 3	1
call 2	5.6
call 1	31.36

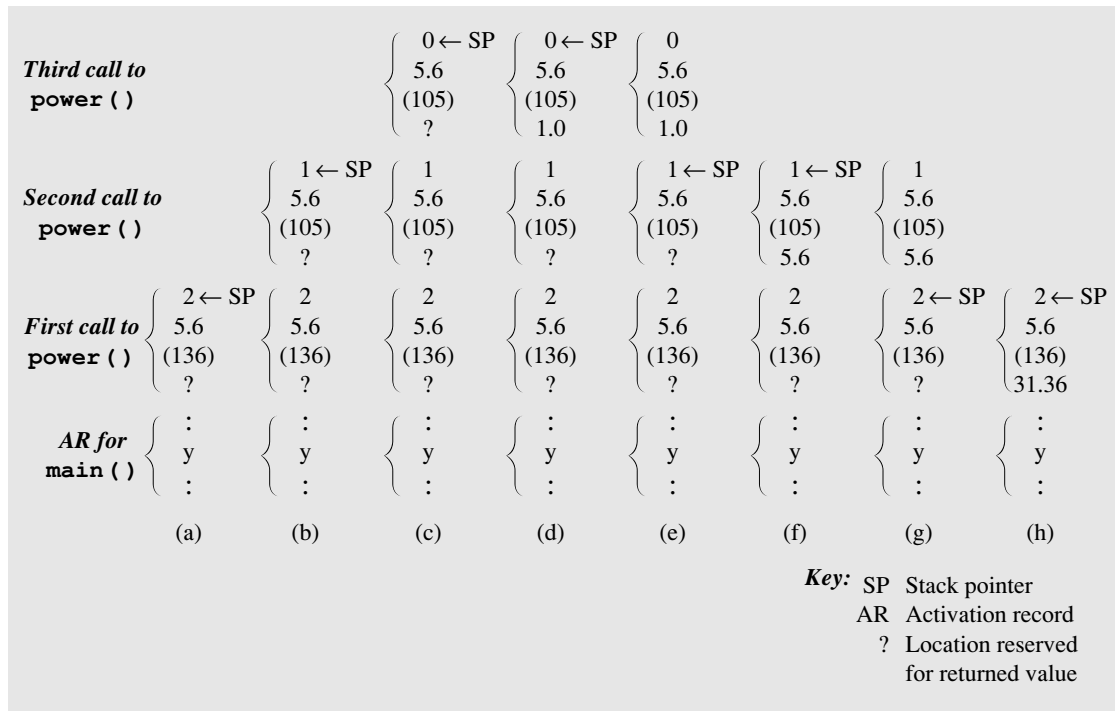
because most of the operations are performed on the run-time stack.

When the method is invoked for the first time, four items are pushed onto the run-time stack: the return address 136, the actual parameters 5.6 and 2, and one location reserved for the value returned by `power()`. Figure 5.2a represents this situation. (In this and subsequent diagrams, SP is a stack pointer, AR is an activation record, and question marks stand for locations reserved for the returned values. To distinguish values from addresses, the latter are parenthesized, although addresses are numbers exactly like method arguments.)

Now the method `power()` is executed. First, the value of the second argument, 2, is checked, and `power()` tries to return the value of  $5.6 \cdot \text{power}(5.6, 1)$  because that argument is not 0. This cannot be done immediately because the system does not know the value of `power(5.6, 1)`; it must be computed first. Therefore, `power()` is called again with the arguments 5.6 and 1. But before this call is executed, the run-time stack receives new items, and its contents are shown in Figure 5.2b.

Again, the second argument is checked to see if it is 0. Because it is equal to 1, `power()` is called for the third time, this time with the arguments 5.6 and 0. Before the method is executed, the system remembers the arguments and the return address by putting them on the stack, not forgetting to allocate one cell for the result. Figure 5.2c contains the new contents of the stack.

Again, the question arises: Is the second argument equal to zero? Because it finally is, a concrete value—namely, 1.0—can be returned and placed on the stack, and the method is finished without making any additional calls. At this point, there are two pending calls on the run-time stack—the calls to `power()`—that have to be completed. How is this done? The system first eliminates the activation record of `power()` that has just finished. This is performed logically by popping all its fields (the result, two arguments, and the return address) off the stack. We say “logically” because physically all these fields remain on the stack and only the SP is decremented appropriately. This is important because we do not want the result to be destroyed since it has not been used yet. Before and after completion of the last call of `power()`, the stack looks the same, but the SP’s value is changed (see Figures 5.2d and 5.2e).

**FIGURE 5.2** Changes to the run-time stack during execution of `power(5.6, 2)`.

Now the second call to `power ( )` can complete because it waited for the result of the call `power (5.6, 0)`. This result, 1.0, is multiplied by 5.6 and stored in the field allocated for the result. After that, the system can pop the current activation record off the stack by decrementing the SP, and it can finish the execution of the first call to `power ( )` that needed the result for the second call. Figure 5.2f shows the contents of the stack before changing the SP's value, and Figure 5.2g shows the contents of the stack after this change. At this moment, `power ( )` can finish its first call by multiplying the result of its second call, 5.6, by its first argument, also 5.6. The system now returns to the method that invoked `power ( )`, and the final value, 31.36, is assigned to `y`. Right before the assignment is executed, the content of the stack looks like Figure 5.2h.

The method `power ( )` can be implemented differently, without using any recursion, by using a loop:

```
double nonRecPower(double x, int n) {
    double result = 1;
    if (n > 0)
        for (result = x; n > 1; --n)
            result *= x;
    return result;
}
```

Do we gain anything by using recursion instead of a loop? The recursive version seems to be more intuitive because it is similar to the original definition of the power function. The definition is simply expressed in Java without losing the original structure of the definition. The recursive version increases program readability, improves self-documentation, and simplifies coding. In our example, the code of the non-recursive version is not substantially larger than in the recursive version, but for most recursive implementations, the code is shorter than it is in the nonrecursive implementations.

## 5.4 TAIL RECURSION

All recursive definitions contain a reference to a set or function being defined. There are, however, a variety of ways such a reference can be implemented. This reference can be done in a straightforward manner or in an intricate fashion, just once or many times. There may be many possible levels of recursion or different levels of complexity. In the following sections, some of these types are discussed, starting with the simplest case, *tail recursion*.

Tail recursion is characterized by the use of only one recursive call at the very end of a method implementation. In other words, when the call is made, there are no statements left to be executed by the method; the recursive call is not only the last statement but there are no earlier recursive calls, direct or indirect. For example, the method `tail()` defined as

```
void tail (int i) {
    if (i > 0) {
        System.out.print (i + "");
        tail(i-1);
    }
}
```

is an example of a method with tail recursion, whereas the method `nonTail()` defined as

```
void nonTail (int i) {
    if (i > 0) {
        nonTail(i-1);
        System.out.print (i + "");
        nonTail(i-1);
    }
}
```

is not. Tail recursion is simply a glorified loop and can be easily replaced by one. In this example, it is replaced by substituting a loop for the `if` statement and incrementing or decrementing the variable `i` in accordance with the level of recursion. In this way, `tail()` can be expressed by an iterative method:

```

void iterativeEquivalentOfTail (int i) {
    for ( ; i > 0; i--)
        System.out.print(i+ " ");
}

```

Is there any advantage in using tail recursion over iteration? For languages such as Java, there may be no compelling advantage, but in a language such as Prolog, which has no explicit loop construct (loops are simulated by recursion), tail recursion acquires a much greater weight. In languages endowed with a loop or its equivalents, such as an `if` statement combined with a `goto` statement or labeled statement, tail recursion should not be used.

## 5.5 NONTAIL RECURSION

Another problem that can be implemented in recursion is printing an input line in reverse order. Here is a simple recursive implementation:

```

/* 200 */ void reverse() {
/* 201 */     char ch = getChar();
/* 202 */     if (ch != '\n') {
/* 203 */         reverse();
/* 204 */         System.out.print(ch);
    }
}

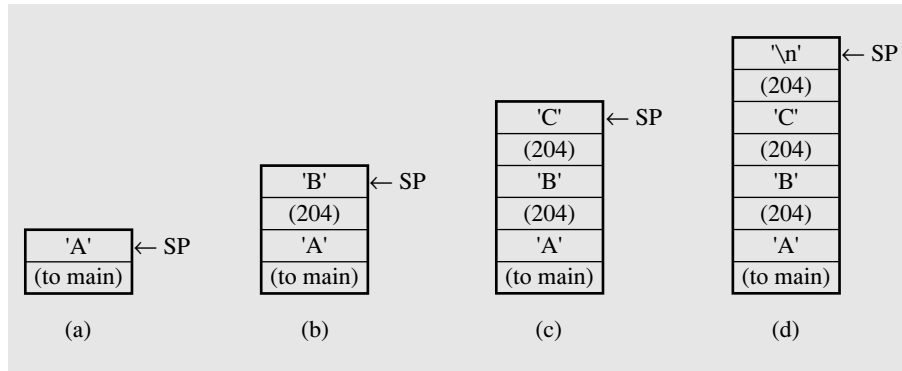
```

Where is the trick? It does not seem possible that the method does anything. But it turns out that, by the power of recursion, it does exactly what it was designed for. `main()` calls `reverse()` and the input is the string: “ABC.” First, an activation record is created with cells for the variable `ch` and the return address. There is no need to reserve a cell for a result, because no value is returned, which is indicated by using `void` in front of the method’s name. A user-defined method `getChar()` reads in the first character, “A.” Figure 5.3a shows the contents of the run-time stack right before `reverse()` calls itself recursively for the first time.

The second character is read in and checked to see if it is the end-of-line character, and if not, `reverse()` is called again. But in either case, the value of `ch` is pushed onto the run-time stack along with the return address. Before `reverse()` is called for a third time (the second time recursively), there are two more items on the stack (see Figure 5.3b).

Note that the method is called as many times as the number of characters contained in the input string, including the end-of-line character. In our example, `reverse()` is called four times, and the run-time stack during the last call is shown in Figure 5.3d.

On the fourth call, `getChar()` finds the end-of-line character and `reverse()` executes no other statement. The system retrieves the return address from the activation record and discards this record by decrementing `SP` by the proper number of bytes. Execution resumes from line 204, which is a print statement. Because the activation record of the third call is now active, the value of `ch`, the letter “C,” is output as

**FIGURE 5.3** Changes on the run-time stack during the execution of `reverse()`.

the first character. Next, the activation record of the third call to `reverse()` is discarded and now SP points to where “B” is stored. The second call is about to be finished, but first, “B” is assigned to `ch` and then the statement on line 204 is executed, which results in printing “B” on the screen right after “C.” Finally, the activation record of the first call to `reverse()` is reached. Then “A” is printed, and what can be seen on the screen is the string “CBA.” The first call is finally finished and the program continues execution in `main()`.

Compare the recursive implementation with a nonrecursive version of the same method:

```
void simpleIterativeReverse() {
    String stack = new String();
    int top = 0;
    try { stack = buffer.readLine();
    } catch (IOException io) {
    }
    for (top = stack.length() - 1; top >= 0; top--)
        System.out.print(stack.charAt(top));
}
```

The method is quite short and, perhaps, a bit more cryptic than its recursive counterpart. What is the difference then? Keep in mind that the brevity and relative simplicity of the second version are due mainly to the fact that we want to reverse a string or array of characters. This means that methods like `length()` and `readLine()` from the standard Java library can be used. If we are not supplied with such methods, then our iterative method has to be implemented differently:

```
void iterativeReverse() {
    char[] stack = new char[80];
    int top = 0;
    stack[top] = getChar();
```

```

while (stack[top] != '\n')
    stack[++top] = getChar();
for (top -= 1; top >= 0; top--)
    System.out.print(stack[top]);
}

```

The `while` loop replaces `getLine()` and the autoincrement of variable `top` replaces `length()`. The `for` loop is about the same as before. This discussion is not purely theoretical because reversing an input line consisting of integers uses the same implementation as `iterativeReverse()` after changing the data type of `stack` from `char` to `int` and modifying the `while` loop.

Note that the variable name `stack` used for the array is not accidental. We are just making explicit what is done implicitly by the system. Our stack takes over the runtime stack's duty. Its use is necessary here because one simple loop does not suffice, as in the case of tail recursion. In addition, the statement `System.out.print()` from the recursive version has to be accounted for. Note also that the variable `stack` is local to the method `iterativeReverse()`. However, if it were a requirement to have a stack object `st`, then this implementation can be written as

```

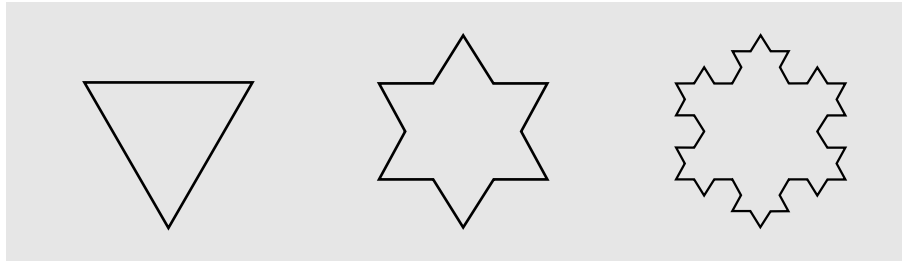
void nonRecursiveReverse() {
    Stack st = new Stack();
    char ch = getChar();
    while (ch != '\n') {
        st.push(new Character(ch));
        ch = getChar();
    }
    while (!st.isEmpty())
        System.out.print((Character) st.pop());
}

```

After comparing `iterativeReverse()` to `nonRecursiveReverse()`, we can conclude that the first version is better because it is faster, no method calls are made, and the method is self-sufficient, whereas `nonRecursiveReverse()` calls at least one method during each loop iteration, slowing down execution.

One way or the other, the transformation of nontail recursion into iteration usually involves the explicit handling of a stack. Furthermore, when converting a method from a recursive into an iterative version, program clarity can be diminished and the brevity of program formulation lost. Iterative versions of recursive Java methods are not as verbose as in other programming languages, so program brevity may not be an issue.

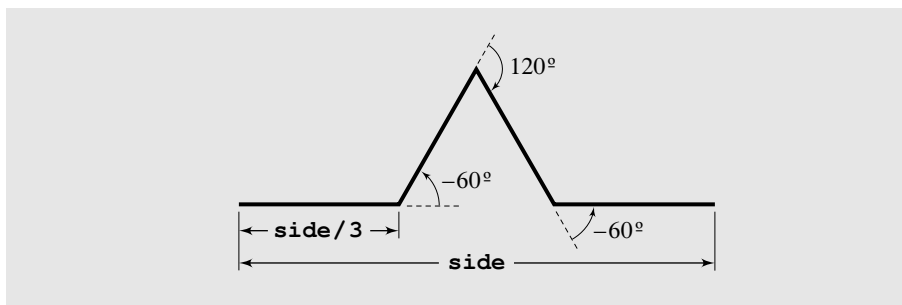
To conclude this section, consider a construction of the von Koch snowflake. The curve was constructed in 1904 by Swedish mathematician Helge von Koch as an example of a continuous and nondifferentiable curve with an infinite length and yet encompassing a finite area. Such a curve is a limit of an infinite sequence of snowflakes, of which the first three are presented in Figure 5.4. As in real snowflakes, two of these curves have six petals, but to facilitate the algorithm, it is treated as a combination of three identical curves drawn in different angles and joined together. One such curve is drawn in the following fashion:

**FIGURE 5.4** Examples of von Koch snowflakes.

1. Divide an interval *side* into three even parts.
2. Move one-third of *side* in the direction specified by *angle*.
3. Turn to the right  $60^\circ$  (i.e., turn  $-60^\circ$ ) and go forward one-third of *side*.
4. Turn to the left  $120^\circ$  and proceed forward one-third of *side*.
5. Turn right  $60^\circ$  and again draw a line one-third of *side* long.

The result of these five steps is summarized in Figure 5.5. This line, however, becomes more jagged if every one of the four intervals became a miniature of the whole curve; that is, if the process of drawing four lines were made for each of these  $side/3$  long intervals. As a result, 16 intervals  $side/9$  long would be drawn. The process may be continued indefinitely—at least in theory. Computer graphics resolution prevents us from going too far because if lines are smaller than the diameter of a pixel, we just see one dot on the screen.

The five steps that instead of drawing one line of length *side*, draw four lines each of length one-third of *side* form one cycle only. Each of these four lines can also be compound lines drawn by the use of the described cycle. This is a situation in which recursion is well suited, which is reflected by the following pseudocode:

**FIGURE 5.5** The process of drawing four sides of one segment of the von Koch snowflake.



```

drawFourLines (side, level)
  if (level = 0)
    draw a line;
  else
    drawFourLines(side/3, level-1);
    turn left 60°;
    drawFourLines(side/3, level-1);
    turn right 120°;
    drawFourLines(side/3, level-1);
    turn left 60°;
    drawFourLines(side/3, level-1);

```

This pseudocode can be rendered almost without change into Java code. However, remember that a line drawn must not be of deliberate length, because the snowflake drawn will not be a closed line. Therefore, the original line is divided into three parts, each of which is divided into three parts also, `level-1` times. Figure 5.6 contains the Java code for this example.

**FIGURE 5.6** Recursive implementation of the von Koch snowflake.

```

import java.awt.*;
import java.awt.event.*;

public class vonKoch extends Frame implements ActionListener {
  private TextField lvl, len;
  vonKoch() {
    super("von Koch snowflake");
    Label lvlLbl = new Label("level");
    lvl = new TextField("4",3);
    Label lenLbl = new Label("side");
    len = new TextField("200",3);
    Button draw = new Button("draw");
    lvl.addActionListener(this);
    len.addActionListener(this);
    draw.addActionListener(this);
    setLayout(new FlowLayout());
    add(lvlLbl);
    add(lvl);
    add(lenLbl);
    add(len);
    add(draw);
    setSize(600,400);
    setForeground(Color.white);

```

*Continues*

**FIGURE 5.6** (continued)

```
        setBackground(Color.red);
        show();
        addWindowListener(new WindowAdapter() {
            public void windowClosing(WindowEvent e) {
                System.exit(0);
            }
        });
    }
    private double angle;
    private Point currPt, pt = new Point();
    private void right(double x) {
        angle += x;
    }
    private void left (double x) {
        angle -= x;
    }
    private void drawFourLines(double side, int level, Graphics g) {
        if (level == 0) {
            // arguments to sin() and cos() must be angles given in
            // radians,
            // thus, the angles given in degrees must be multiplied by
            // PI/180;
            pt.x = ((int)(Math.cos(angle*Math.PI/180)*side)) + currPt.x;
            pt.y = ((int)(Math.sin(angle*Math.PI/180)*side)) + currPt.y;
            g.drawLine(currPt.x, currPt.y, pt.x, pt.y);
            currPt.x = pt.x;
            currPt.y = pt.y;
        }
        else {
            drawFourLines(side/3.0,level-1,g);
            left (60);
            drawFourLines(side/3.0,level-1,g);
            right(120);
            drawFourLines(side/3.0,level-1,g);
            left (60);
            drawFourLines(side/3.0,level-1,g);
        }
    }
    public void actionPerformed(ActionEvent e) { // ActionListener
        repaint();
    }
}
```

**FIGURE 5.6** (continued)

```

public void paint(Graphics g) {
    int level = Integer.parseInt(lvl.getText().trim());
    double side = Double.parseDouble(len.getText().trim());
    currPt = new Point(200,150);
    angle = 0;
    for (int i = 1; i <= 3; i++) {
        drawFourLines(side,level,g);
        right(120);
    }
}
static public void main(String[] a) {
    new vonKoch();
}
}

```

## 5.6 INDIRECT RECURSION

The preceding sections discussed only direct recursion, where a method  $f()$  called itself. However,  $f()$  can call itself indirectly via a chain of other calls. For example,  $f()$  can call  $g()$ , and  $g()$  can call  $f()$ . This is the simplest case of indirect recursion.

The chain of intermediate calls can be of an arbitrary length, as in:

$$f() \rightarrow f_1() \rightarrow f_2() \rightarrow \dots \rightarrow f_n() \rightarrow f()$$

There is also the situation when  $f()$  can call itself indirectly through different chains. Thus, in addition to the chain just given, another chain might also be possible. For instance

$$f() \rightarrow g_1() \rightarrow g_2() \rightarrow \dots \rightarrow g_m() \rightarrow f()$$

This situation can be exemplified by three methods used for decoding information. `receive()` stores the incoming information in a buffer, `decode()` converts it into legible form, and `store()` stores it in a file. `receive()` fills the buffer and calls `decode()`, which in turn, after finishing its job, submits the buffer with decoded information to `store()`. After `store()` accomplishes its tasks, it calls `receive()` to intercept more encoded information using the same buffer. Therefore, we have the chain of calls

$$\text{receive}() \rightarrow \text{decode}() \rightarrow \text{store}() \rightarrow \text{receive}() \rightarrow \text{decode}() \rightarrow \dots$$

which is finished when no new information arrives. These three methods work in the following manner:

```

receive(buffer)
  while buffer is not filled up
    if information is still incoming
      get a character and store it in buffer;
    else exit();
    decode(buffer);

decode(buffer)
  decode information in buffer;
  store(buffer);

store(buffer)
  transfer information from buffer to file;
  receive(buffer);

```

A more mathematically oriented example concerns formulas calculating the trigonometric functions sine, cosine, and tangent:

$$\sin(x) = \sin\left(\frac{x}{3}\right) \cdot \frac{\left(3 - \tan^2\left(\frac{x}{3}\right)\right)}{\left(1 + \tan^2\left(\frac{x}{3}\right)\right)}$$

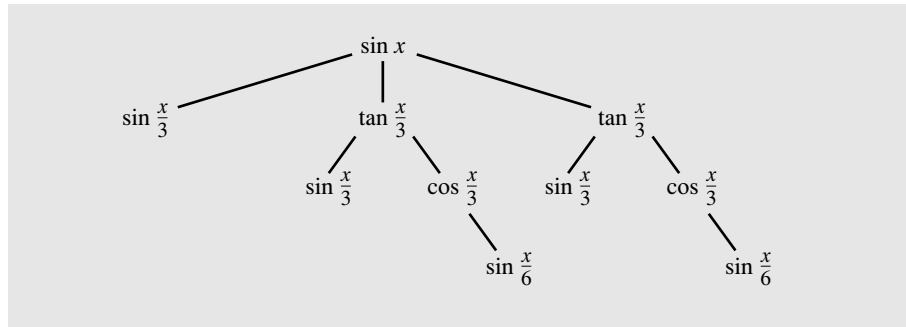
$$\tan(x) = \frac{\sin(x)}{\cos(x)}$$

$$\cos(x) = 1 - \sin\left(\frac{x}{2}\right)$$

As usual in the case of recursion, there has to be an anchor in order to avoid falling into an infinite loop of recursive calls. In the case of sine, we can use the following approximation:

$$\sin(x) \approx x - \frac{x^3}{6}$$

where small values of  $x$  give a better approximation. To compute the sine of a number  $x$  such that its absolute value is greater than an assumed tolerance, we have to compute  $\sin\left(\frac{x}{3}\right)$  directly,  $\sin\left(\frac{x}{3}\right)$  indirectly through tangent, and also indirectly,  $\sin\left(\frac{x}{6}\right)$  through tangent and cosine. If the absolute value of  $\frac{x}{3}$  is sufficiently small, which does not require other recursive calls, we can represent all the calls as a tree, as in Figure 5.7.

**FIGURE 5.7** A tree of recursive calls for  $\sin(x)$ .

## 5.7 NESTED RECURSION

A more complicated case of recursion is found in definitions in which a function is not only defined in terms of itself, but also is used as one of the parameters. The following definition is an example of such a nesting:

$$h(n) = \begin{cases} 0 & \text{if } n = 0 \\ n & \text{if } n > 4 \\ h(2 + h(2n)) & \text{if } n \leq 4 \end{cases}$$

Function  $h$  has a solution for all  $n \geq 0$ . This fact is obvious for all  $n > 4$  and  $n = 0$ , but it has to be proven for  $n = 1, 2, 3$ , and  $4$ . Thus,  $h(2) = h(2 + h(4)) = h(2 + h(2 + h(8))) = 12$ . (What are the values of  $h(n)$  for  $n = 1, 3$ , and  $4$ ?)

Another example of nested recursion is a very important function originally suggested by Wilhelm Ackermann in 1928 and later modified by Rosza Peter:

$$A(n, m) = \begin{cases} m + 1 & \text{if } n = 0 \\ A(n - 1, 1) & \text{if } n > 0, m = 0 \\ A(n - 1, A(n, m - 1)) & \text{otherwise} \end{cases}$$

This function is interesting because of its remarkably rapid growth. It grows so fast that it is guaranteed not to have a representation by a formula that uses arithmetic operations such as addition, multiplication, and exponentiation. To illustrate the rate of growth of the Ackermann function, we need only show that

$$A(3, m) = 2^{m+3} - 3$$

$$A(4, m) = 2^{2^{\dots^{2^{16}}}} - 3$$

with a stack of  $m$  2s in the exponent;  $A(4, 1) = 2^{2^{16}} - 3 = 2^{65536} - 3$ , which exceeds even the number of atoms in the universe (which is  $10^{80}$  according to current theories).

The definition translates very nicely into Java, but the task of expressing it in a nonrecursive form is truly troublesome.

## 5.8 EXCESSIVE RECURSION

Logical simplicity and readability are used as an argument supporting the use of recursion. The price for using recursion is slowing down execution time and storing on the run-time stack more things than required in a nonrecursive approach. If recursion is too deep (for example, computing  $5.6^{100,000}$ ), then we can run out of space on the stack and our program terminates abnormally by raising an unrecoverable `StackOverflowError`. But usually, the number of recursive calls is much smaller than 100,000, so the danger of overflowing the stack may not be imminent.<sup>2</sup> However, if some recursive function repeats the computations for some parameters, the run time can be prohibitively long even for very simple cases.

Consider Fibonacci numbers. A sequence of Fibonacci numbers is defined as follows:

$$\text{Fib}(n) = \begin{cases} n & \text{if } n < 2 \\ \text{Fib}(n-2) + \text{Fib}(n-1) & \text{otherwise} \end{cases}$$

The definition states that if the first two numbers are 0 and 1, then any number in the sequence is the sum of its two predecessors. But these predecessors are in turn sums of their predecessors, and so on, to the beginning of the sequence. The sequence produced by the definition is

0, 1, 1, 2, 3, 5, 8, 13, 21, 34, 55, 89, . . .

How can this definition be implemented in Java? It takes almost term-by-term translation to have a recursive version, which is

```
int Fib (int n) {
    if (n < 2)
        return n;
    else return Fib(n-2) + Fib(n-1);
}
```

The method is simple and easy to understand but extremely inefficient. To see it, compute `Fib(6)`, the seventh number of the sequence, which is 8. Based on the definition, the computation runs as follows:

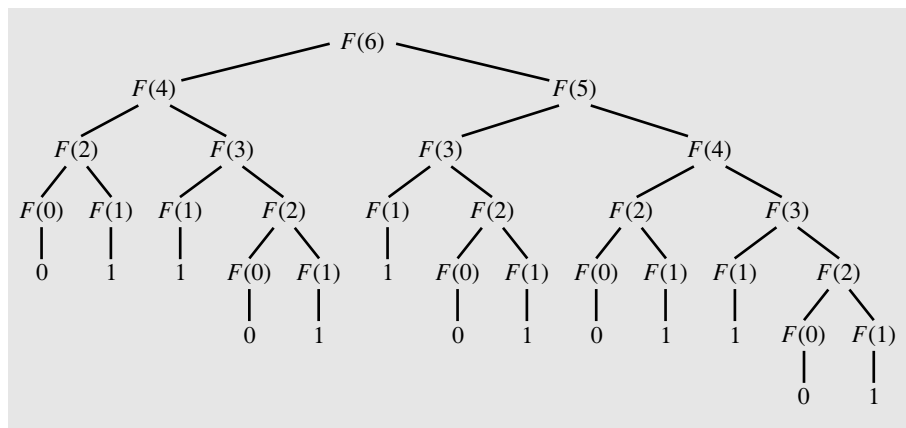
```
Fib(6) =          Fib(4)          + Fib(5)
      =   Fib(2)      +      Fib(3)      + Fib(5)
      = Fib(0)+Fib(1)  +      Fib(3)      + Fib(5)
      =  0  +  1      +      Fib(3)      + Fib(5)
      =  1          + Fib(1)+  Fib(2)      + Fib(5)
      =  1          + Fib(1)+Fib(0)+Fib(1) + Fib(5)
```

etc.

<sup>2</sup>Even if we try to compute the value of  $5.6^{100,000}$  using an iterative algorithm, we are not completely free from a troublesome situation because the number is much too large to fit even a variable of double length. Thus, although the program would not crash, the computed value would be incorrect, which may be even more dangerous than a program crash.

This is just the beginning of our calculation process, and even here there are certain shortcuts. All these calculations can be expressed more concisely in the form of the tree shown in Figure 5.8. Tremendous inefficiency results because `Fib()` is called 25 times to determine the seventh element of the Fibonacci sequence. The source of this inefficiency is the repetition of the same calculations because the system forgets what has already been calculated. For example, `Fib()` is called eight times with parameter `n = 1` to decide that 1 can be returned. For each number of the sequence, the method computes all its predecessors without taking into account that it suffices to do this only once. To find `Fib(6) = 8`, it computes `Fib(5)`, `Fib(4)`, `Fib(3)`, `Fib(2)`, `Fib(1)`, and `Fib(0)` first. To determine these values, `Fib(4)`,  $\dots$ , `Fib(0)` have to be computed to know the value of `Fib(5)`. Independently of this, the chain of computations `Fib(3)`,  $\dots$ , `Fib(0)` is executed to find `Fib(4)`.

**FIGURE 5.8** The tree of calls for `Fib(6)`.



We can prove that the number of additions required to find `Fib(n)` using a recursive definition is equal to  $\text{Fib}(n + 1) - 1$ . Counting two calls per one addition plus the very first call means that `Fib()` is called  $2 \cdot \text{Fib}(n + 1) - 1$  times to compute `Fib(n)`. This number can be exceedingly large for fairly small  $n$ s, as the table in Figure 5.9 indicates.

It takes almost a quarter of a million calls to find the twenty-sixth Fibonacci number, and nearly 3 million calls to determine the thirty-first! This is too heavy a price for the simplicity of the recursive algorithm. As the number of calls and the run time grow exponentially with  $n$ , the algorithm has to be abandoned except for very small numbers.

An iterative algorithm may be produced rather easily as follows:

```
int iterativeFib (int n) {
    if (n < 2)
        return n;
    else {
        int i = 2, tmp, current = 1, last = 0;
```

**FIGURE 5.9** Number of addition operations and number of recursive calls to calculate Fibonacci numbers.

n	Fib(n+1)	Number of Additions	Number of Calls
6	13	12	25
10	89	88	177
15	987	986	1,973
20	10,946	10,945	21,891
25	121,393	121,392	242,785
30	1,346,269	1,346,268	2,692,537

```

        for ( ; i <= n; ++i) {
            tmp = current;
            current += last;
            last = tmp;
        }
        return current;
    }
}

```

For each  $n > 1$ , the method loops  $n - 1$  times making three assignments per iteration and only one addition, disregarding the autoincrement of  $i$  (see Figure 5.10).

However, there is another, numerical method for computing  $\text{Fib}(n)$ , using a formula discovered by A. de Moivre:

$$\text{Fib}(n) = \frac{\phi^n - \hat{\phi}^n}{\sqrt{5}}$$

where  $\phi = \frac{1}{2}(1 + \sqrt{5})$  and  $\hat{\phi} = 1 - \phi = \frac{1}{2}(1 - \sqrt{5}) \approx -0.618034$ . Because  $-1 < \hat{\phi} < 0$ ,  $\hat{\phi}^n$  becomes very small when  $n$  grows. Therefore, it can be omitted from the formula and

$$\text{Fib}(n) = \frac{\phi^n}{\sqrt{5}}$$

approximated to the nearest integer. This leads us to the third implementation for computing a Fibonacci number:

```

long deMoivreFib (int n) {
    return Math.round(Math.exp(n*Math.log(1.6180339897) - Math.log(2.2360679775)));
}

```

Try to justify this implementation using the definition of logarithm.



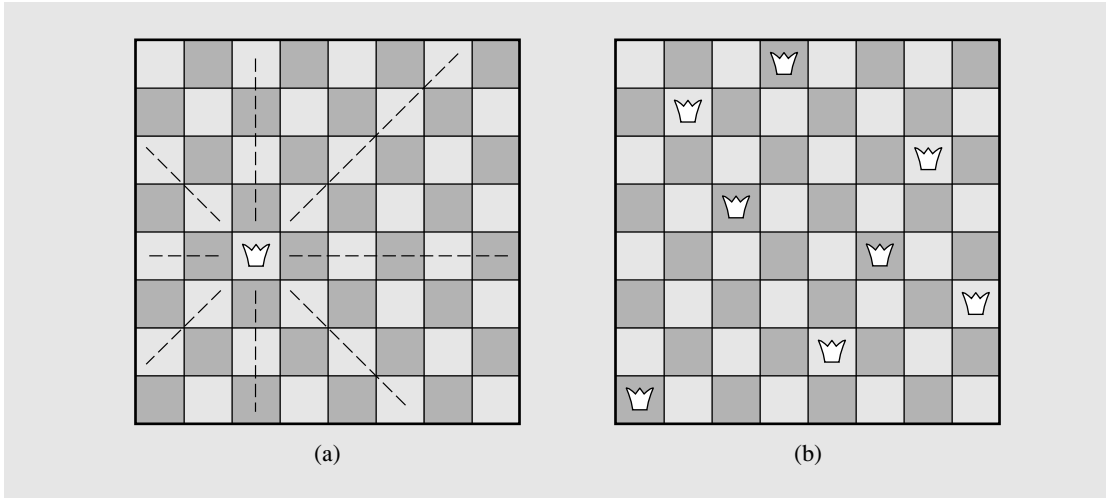
**FIGURE 5.10** Comparison of iterative and recursive algorithms for calculating Fibonacci numbers.

n	Number of Additions	Assignments	
		Iterative Algorithm	Recursive Algorithm
6	5	15	25
10	9	27	177
15	14	42	1,973
20	19	57	21,891
25	24	72	242,785
30	29	87	2,692,537

## 5.9 BACKTRACKING

In solving some problems, a situation arises where there are different ways leading from a given position, none of them known to lead to a solution. After trying one path unsuccessfully, we return to this crossroads and try to find a solution using another path. However, we must ensure that such a return is possible and that all paths can be tried. This technique is called *backtracking*, and it allows us to systematically try all available avenues from a certain point after some of them lead to nowhere. Using backtracking, we can always return to a position that offers other possibilities for successfully solving the problem. This technique is used in artificial intelligence, and one of the problems in which backtracking is very useful is the eight queens problem.

The eight queens problem attempts to place eight queens on a chessboard in such a way that no queen is attacking any other. The rules of chess say that a queen can take another piece if it lies on the same row, on the same column, or on the same diagonal as the queen (see Figure 5.11). To solve this problem, we try to put the first queen on the board, then the second so that it cannot take the first, then the third so that it is not in conflict with the two already placed, and so on, until all of the queens are placed. What happens if, for instance, the sixth queen cannot be placed in a nonconflicting position? We choose another position for the fifth queen and try again with the sixth. If this does not work the fifth queen is moved again. If all the possible positions for the fifth queen have been tried, the fourth queen is moved and then the process restarts. This process requires a great deal of effort, most of which is spent backtracking to the first crossroads offering some untried avenues. In terms of code, however, the process is rather simple due to the power of recursion, which is a natural implementation of backtracking. Pseudocode for this backtracking algorithm is as follows (the last line pertains to backtracking):

**FIGURE 5.11** The eight queens problem.

```

putQueen(row)
  for every position col on the same row
    if position col is available
      place the next queen in position col;
      if (row < 8)
        putQueen(row+1);
      else success;
      remove the queen from position col;

```

This algorithm finds all possible solutions without regard to the fact that some of them are symmetrical.

The most natural approach for implementing this algorithm is to declare an  $8 \times 8$  array `board` of 1s and 0s representing a chessboard. The array is initialized to 1s, and each time a queen is put in a position  $(r, c)$ , `board[r][c]` is set to 0. Also, a method must set to 0, as not available, all positions on row  $r$ , in column  $c$ , and on both diagonals that cross each other in position  $(r, c)$ . When backtracking, the same positions (that is, positions on corresponding row, column, and diagonals) have to be set back to 1, as again available. Because we can expect hundreds of attempts to find available positions for queens, the setting and resetting process is the most time-consuming part of the implementation; for each queen, between 22 and 28 positions have to be set and then reset, 15 for row and column, and between 7 and 13 for diagonals.

In this approach, the board is viewed from the perspective of the player who sees the entire board along with all the pieces at the same time. However, if we focus solely on the queens, we can consider the chessboard from their perspective. For the queens, the board is not divided into squares, but into rows, columns, and diagonals. If a

queen is placed on a single square, it resides not only on this square, but on the entire row, column, and diagonal, treating them as its own temporary property. A different data structure can be utilized to represent this.

To simplify the problem for the first solution, we use a  $4 \times 4$  chessboard instead of the regular  $8 \times 8$  board. Later, we can make the rather obvious changes in the program to accommodate a regular board.

Figure 5.12 contains the  $4 \times 4$  chessboard. Notice that indexes in all fields in the indicated left diagonal all add up to two,  $r + c = 2$ ; this number is associated with this diagonal. There are seven left diagonals, 0 through 6. Indexes in the fields of the indicated right diagonal all have the same difference,  $r - c = -1$ , and this number is unique among all right diagonals. Therefore, right diagonals are assigned numbers  $-3$  through 3. The data structure used for all left diagonals is simply an array indexed by numbers 0 through 6. For right diagonals, it is also an array, but it cannot be indexed by negative numbers. Therefore, it is an array of seven cells, but to account for negative values obtained from the formula  $r - c$ , the same number is always added to it so as not to cross the bounds of this array.

**FIGURE 5.12** A  $4 \times 4$  chessboard.

0, 0	0, 1	0, 2	0, 3
1, 0	1, 1	1, 2	1, 3
2, 0	2, 1	2, 2	2, 3
3, 0	3, 1	3, 2	3, 3

An analogous array is also needed for columns, but not for rows, because a queen  $i$  is moved along row  $i$  and all queens  $< i$  have already been placed in rows  $< i$ . Figure 5.13 contains the code to implement these arrays. The program is short due to recursion, which hides some of the goings-on from the user's sight.

Figures 5.14 through 5.17 document the steps taken by `putQueen()` to place four queens on the chessboard. Figure 5.14 contains the move number, queen number, and row and column number for each attempt to place a queen. Figure 5.15 contains the changes to the arrays `positionInRow`, `column`, `leftDiagonal`, and `rightDiagonal`. Figure 5.16 shows the changes to the run-time stack during the eight steps. All changes to the run-time stack are depicted by an activation record for each iteration of the `for` loop, which mostly lead to a new invocation of `putQueen()`. Each activation record stores a return address and the values of `row` and `col`. Figure 5.17 illustrates the changes to the chessboard. A detailed description of each step follows.

**FIGURE 5.13** Eight queens problem implementation.

```

import java.io.*;

class Queens {
    final boolean available = true;
    final int squares = 4, norm = squares - 1;
    int[] positionInRow = new int[squares];
    boolean[] column = new boolean[squares];
    boolean[] leftDiagonal = new boolean[squares*2 - 1];
    boolean[] rightDiagonal = new boolean[squares*2 - 1];
    int howMany = 0;
    Queens() {
        for (int i = 0; i < squares; i++) {
            positionInRow[i] = -1;
            column[i] = available;
        }
        for (int i = 0; i < squares*2 - 1; i++)
            leftDiagonal[i] = rightDiagonal[i] = available;
    }
    void PrintBoard(PrintStream out) {
        . . . . .
    }
    void PutQueen(int row) {
        for (int col = 0; col < squares; col++)
            if (column[col] == available &&
                leftDiagonal [row+col] == available &&
                rightDiagonal[row-col+norm] == available) {
                positionInRow[row] = col;
                column[col] = !available;
                leftDiagonal[row+col] = !available;
                rightDiagonal[row-col+norm] = !available;
                if (row < squares-1)
                    PutQueen(row+1);
                else PrintBoard(System.out);
                column[col] = available;
                leftDiagonal[row+col] = available;
                rightDiagonal[row-col+norm] = available;
            }
    }
    static public void main(String args[]) {
        Queens queens = new Queens();
        queens.PutQueen(0);
        System.out.println(queens.howMany + " solutions found.");
    }
}

```

**FIGURE 5.14** Steps leading to the first successful configuration of four queens as found by the method `putQueen()`.

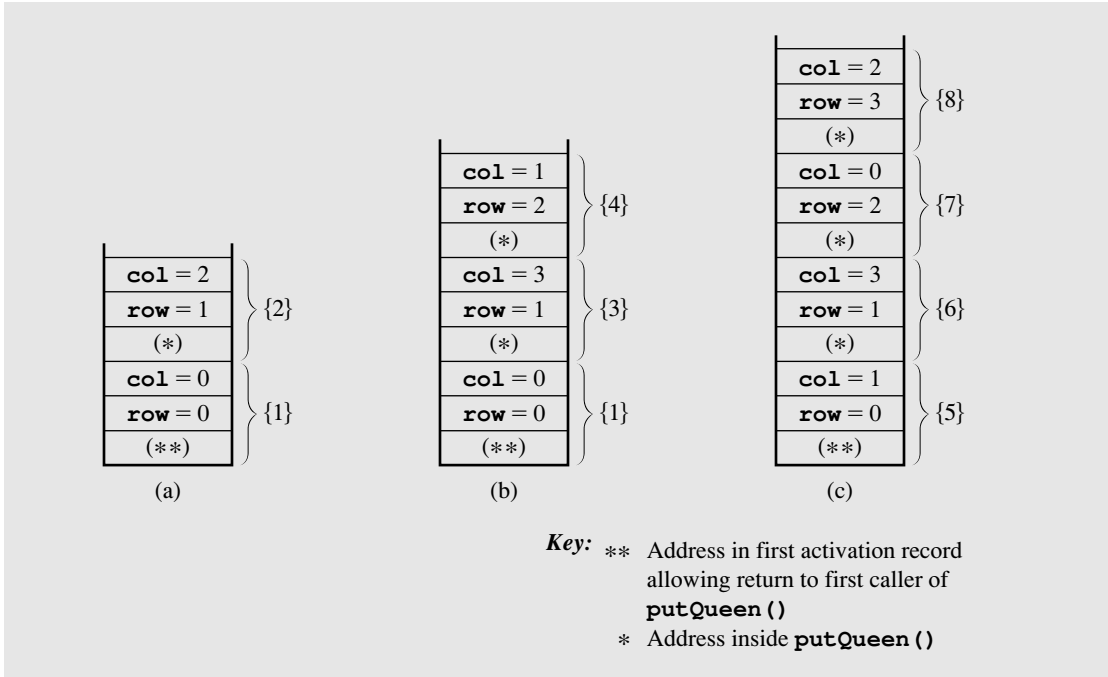
Move	Queen	row	col	
{1}	1	0	0	
{2}	2	1	2	failure
{3}	2	1	3	
{4}	3	2	1	failure
{5}	1	0	1	
{6}	2	1	3	
{7}	3	2	0	
{8}	4	3	2	

**FIGURE 5.15** Changes in the four arrays used by method `putQueen()`.

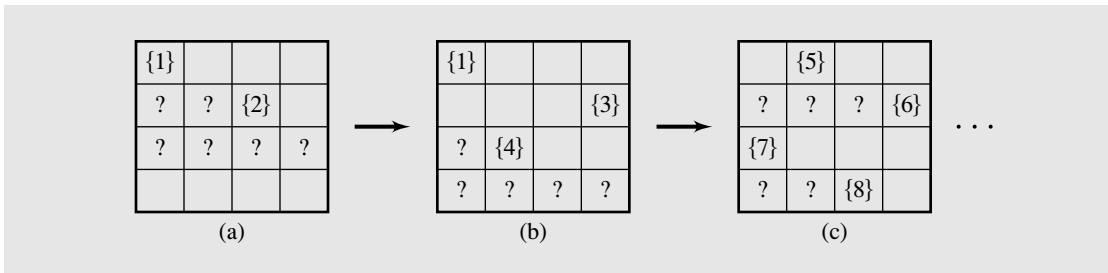
positionInRow	column	leftDiagonal	rightDiagonal	row
(0, 2, , )	(!a, a, !a, a)	(!a, a, a, !a, a, a, a)	(a, a, !a, !a, a, a, a)	0, 1
{1}{2}	{1} {2}	{1} {2}	{2}{1}	{1}{2}
(0, 3, 1, )	(!a, !a, a, !a)	(!a, a, a, !a, !a, a, a)	(a, !a, a, !a, !a, a, a)	1, 2
{1}{3}{4}	{1} {4} {3}	{1} {4}{3}	{3} {1} {4}	{3}{4}
(1, 3, 0, 2)	(!a, !a, !a, !a)	(a, !a, !a, a, !a, !a, a)	(a, !a, !a, a, !a, !a, a)	0, 1, 2, 3
{5} {6} {7} {8}	{7} {5} {8} {6}	{5} {7} {6} {8}	{6} {5} {8} {7}	{5}{6}{7}{8}

- {1}** We start by trying to put the first queen in the upper left corner (0, 0). Because it is the very first move, the condition in the `if` statement is met, and the queen is placed in this square. After the queen is placed, the column 0, the main right diagonal, and the leftmost diagonal are marked as unavailable. In Figure 5.15, {1} is put underneath cells reset to `!available` in this step.
- {2}** Since `row < 3`, `putQueen()` calls itself with `row+1`, but before its execution, an activation record is created on the run-time stack (see Figure 5.16a). Now we check the availability of a field on the second row (i.e., `row==1`). For `col==0`, column 0 is guarded, for `col==1`, the main right diagonal is checked, and for `col==2`, all three parts of the `if` statement condition are true. Therefore, the second queen is placed in

**FIGURE 5.16** Changes on the run-time stack for the first successful completion of `putQueen()`.



**FIGURE 5.17** Changes to the chessboard leading to the first successful configuration.



position (1, 2), and this fact is immediately reflected in the proper cells of all four arrays. Again, `row < 3`. `putQueen()` is called trying to locate the third queen in row 2. After all the positions in this row, 0 through 3, are tested, no available position is found, the `for` loop is exited without executing the body of the `if` statement, and this call to `putQueen()` is complete. But this call was executed by `putQueen()` dealing with the second row, to which control is now returned.

- {3} Values of `col` and `row` are restored and the execution of the second call of `putQueen()` continues by resetting some fields in three arrays back to `available`, and since `col==2`, the `for` loop can continue iteration. The test in the `if` statement allows the second queen to be placed on the board, this time in position (1, 3).
- {4} Afterward, `putQueen()` is called again with `row==2`, the third queen is put in (2, 1), and after the next call to `putQueen()`, an attempt to place the fourth queen is unsuccessful (see Figure 5.17b). No calls are made, the call from step {3} is resumed, and the third queen is once again moved, but no position can be found for it. At the same time, `col` becomes 3, and the `for` loop is finished.
- {5} As a result, the first call of `putQueen()` resumes execution by placing the first queen in position (0, 1).
- {6–8} This time execution continues smoothly and we obtain a complete solution.

Figure 5.18 contains a trace of all calls leading to the first successful placement of four queens on a  $4 \times 4$  chessboard.

---

**FIGURE 5.18** Trace of calls to `putQueen()` to place four queens.

```

putQueen(0);
  col = 0;
  putQueen(1);
    col = 0;
    col = 1;
    col = 2;
    putQueen(2)
      col = 0;
      col = 1;
      col = 2;
      col = 3;
      col = 3;
      putQueen(2);
        col = 0;
        col = 1;
        putQueen(3);
          col = 0;
          col = 1;
          col = 2;
          col = 3;
          col = 2;
          col = 3;
        col = 1;

```

*Continues*

**FIGURE 5.18** (continued)

```
putQueen(1);
    col = 0;
    col = 1;
    col = 2;
    col = 3;
    putQueen(2)
        col = 0;
        putQueen(3)
            col = 0;
            col = 1;
            col = 2;
            success;
```

## 5.10 CONCLUDING REMARKS

After looking at all these examples (and one more to follow), what can be said about recursion as a programming tool? Like any other topic in data structures, it should be used with good judgment. There are no general rules for when to use it and when not to use it. Each particular problem decides. Recursion is usually less efficient than its iterative equivalent. But if a recursive program takes 100 milliseconds (ms) for execution, for example, and the iterative version only 10 ms, then although the latter is 10 times faster, the difference is hardly perceivable. If there is an advantage in the clarity, readability, and simplicity of the code, the difference in the execution time between these two versions can be disregarded. Recursion is often simpler than the iterative solution and more consistent with the logic of the original algorithm. The factorial and power methods are such examples, and we will see more interesting cases in chapters to follow.

Although every recursive method can be converted into an iterative version, the conversion is not always a trivial task. In particular, it may involve explicitly manipulating a stack. That is where the time–space trade-off comes into play: Using iteration often necessitates the introduction of a new data structure to implement a stack, whereas recursion relieves the programmer of this task by handing it over to the system. One way or the other, if nontail recursion is involved, very often a stack has to be maintained by the programmer or by the system. But the programmer decides who carries the load.

Two situations can be presented in which a nonrecursive implementation is preferable even if recursion is a more natural solution. First, iteration should be used in the so-called real-time systems where an immediate response is vital for proper functioning of the program. For example, in military environments, in the space shuttle, or in certain types of scientific experiments, it may matter whether the response



time is 10 ms or 100 ms. Second, the programmer is encouraged to avoid recursion in programs that are executed hundreds of times. The best example of this kind of program is a compiler.

But these remarks should not be treated too stringently, because sometimes a recursive version is faster than a nonrecursive implementation. Hardware may have built-in stack operations that considerably speed up methods operating on the run-time stack, such as recursive methods. Running a simple routine implemented recursively and iteratively and comparing the two run times can help to decide if recursion is advisable—in fact, recursion can execute faster than iteration. Such a test is especially important if tail recursion comes into play. However, when a stack cannot be eliminated from the iterative version, the use of recursion is usually recommended, because the execution time for both versions does not differ substantially—certainly not by a factor of 10.

Recursion should be eliminated if some part of the work is unnecessarily repeated to compute the answer. The Fibonacci series computation is a good example of such a situation. It shows that the ease of using recursion can sometimes be deceptive, and this is where iteration can grapple effectively with run-time limitations and inefficiencies. Whether a recursive implementation leads to unnecessary repetitions may not be immediately apparent; therefore, drawing a tree of calls similar to Figure 5.8 can be very helpful. This tree shows that  $\text{Fib}(n)$  is called many times with the same argument  $n$ . A tree drawn for power or factorial methods is reduced to a linked list with no repetitions in it. If such a tree is very deep (that is, it has many levels), then the program can endanger the run-time stack with an overflow. If the tree is shallow and bushy, with many nodes on the same level, then recursion seems to be a good approach—but only if the number of repetitions is very moderate.

## 5.11

### CASE STUDY: A RECURSIVE DESCENT INTERPRETER

All programs written in any programming language have to be translated into a representation that the computer system can execute. However, this is not a simple process. Depending on the system and programming language, the process may consist of translating one executable statement at a time and immediately executing it, which is called *interpretation*, or translating the entire program first and then executing it, which is called *compilation*. Whichever strategy is used, the program should not contain sentences or formulas that violate the formal specification of the programming language in which the program is written. For example, if we want to assign a value to a variable, we must put the variable first, then the equal sign, and then a value after it.

Writing an interpreter is by no means a trivial task. As an example, this case study is a sample interpreter for a limited programming language. Our language consists only of assignment statements; it contains no declarations, *if-else* statements, loops, methods, or the like. For this limited language, we would like to write a program that accepts any input and

- determines if it contains valid assignment statements (this process is known as parsing); and simultaneously,
- evaluates all expressions.

Our program is an interpreter in that it not only checks whether the assignment statements are syntactically correct, but also executes the assignments.

The program is to work in the following way. If we enter the assignment statements

```
var1 = 5;
var2 = 3 + var1;
var3 = 44/2.5 * (var2 + var1);
```

then the system can be prompted for the value of each variable separately. For instance, after entering

```
print var3
```

the system should respond by printing

```
var3 = 228.8
```

Evaluation of all variables stored so far may be requested by entering

```
status
```

and the following values should be printed in our example:

```
var1 = 5.0;
var2 = 8.0;
var3 = 228.8;
```

All current values are to be stored on `idList` and updated if necessary. Thus, if

```
var2 = var2 * 5;
```

is entered, then

```
print var2
```

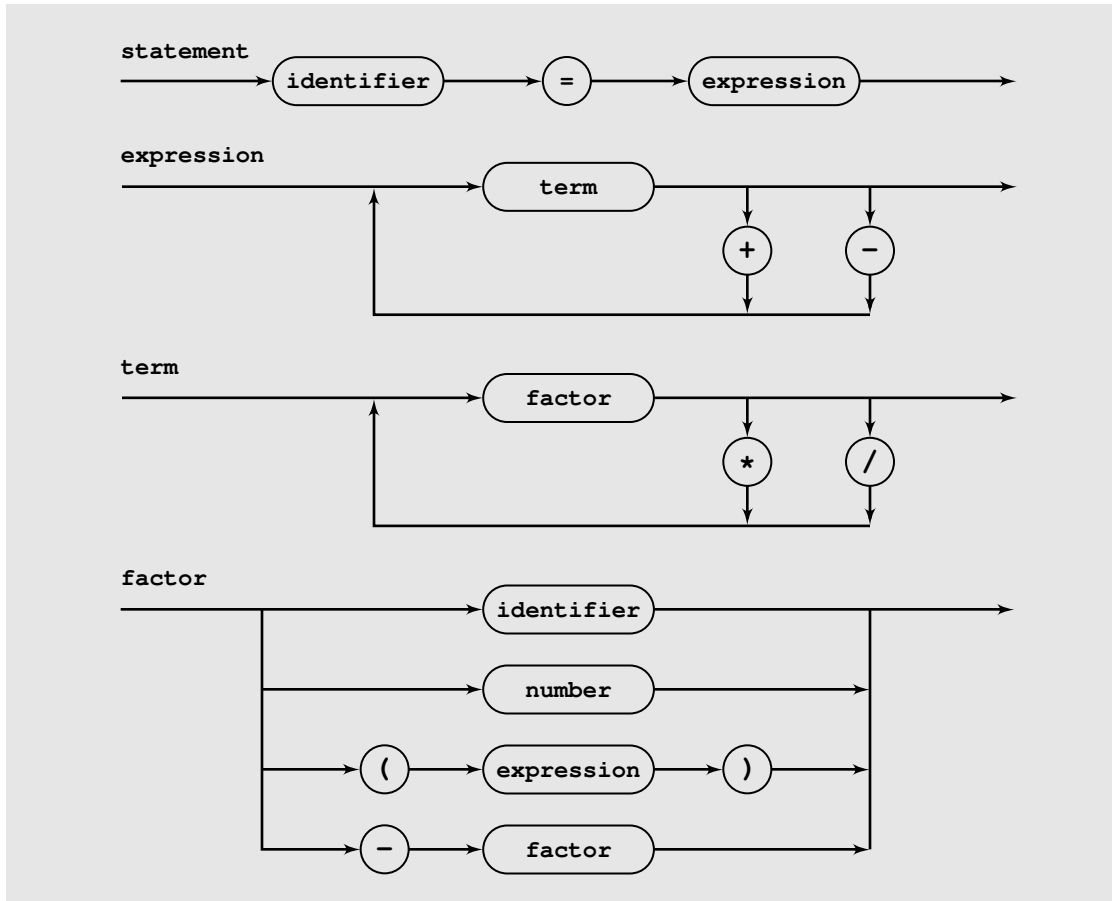
should return

```
var2 = 40.0
```

The interpreter prints a message if any undefined identifier is used and if statements and expressions do not conform to common grammatical rules such as unmatched parentheses, two identifiers in a row, and so on.

The program can be written in a variety of ways, but to illustrate recursion, we chose a method known as *recursive descent*. This consists of several mutually recursive methods according to the diagrams in Figure 5.19.

These diagrams serve to define a statement and its parts. For example, a term is a factor or a factor followed by either the multiplication symbol “\*” or the division symbol “/” and then another factor. A factor, in turn, is either an identifier, a number, an expression enclosed in a pair of matching parentheses, or a negated factor. In this

**FIGURE 5.19** Diagrams of methods used by the recursive descent interpreter.

method, a statement is looked at in more and more detail. It is broken down into its components, and if the components are compound, they are separated into their constituent parts until the simplest language elements or tokens are found: numbers, variable names, operators, and parentheses. Thus, the program recursively descends from a global overview of the statement to more detailed elements.

The diagrams in Figure 5.19 indicate that recursive descent is a combination of direct and indirect recursion. For example, a factor can be a factor preceded by a minus, an expression can be a term, a term can be a factor, a factor can be an expression that, in turn, can be a term, until the level of identifiers or numbers is found. Thus, an expression can be composed of expressions, a term of terms, and a factor of factors.

How can the recursive descent interpreter be implemented? The simplest approach is to treat every word in the diagrams as a method name. For instance, `term()`

is a method returning a double number. This method always calls `factor()` first, and if the current token is either “\*” or “/”, then `term()` calls `factor()` again. Each time, the value already accumulated by `term()` is either multiplied or divided by the value returned by the subsequent call of `term()` to `factor()`. Every call of `term()` can invoke another call to `term()` indirectly through the chain `term() -> factor() -> expression() -> term()`. Pseudocode for the method `term()` looks like the following:

```
term()
    f1 = factor();
    while current token is either / or *
        f2 = factor();
        f1 = f1 * f2 or f1 / f2;
    return f1;
```

The method `expression()` has exactly the same structure, and the pseudocode for `factor()` is:

```
factor()
    process all +s and -s preceding a factor;
    if current token is an identifier
        return value assigned to the identifier;
    else if current token is a number
        return the number;
    else if current token is (
        e = expression();
        if current token is )
            return e;
```

However, in the pseudocode, we assumed that only valid statements are entered for evaluation. What happens if a mistake is made, such as entering two equal signs, mistyping a variable name, or forgetting an operator? In the interpreter, parsing is simply discontinued after printing an error message.

In the implementation, a stream tokenizer is used to divide input statements into tokens: identifiers, numbers, operators, parentheses, and semicolons. However, in the stream tokenizer, a word is a letter followed by zero or more letters or number constituents. Because number constituents are digits, a period, and a minus, a string tokenizer would accept “x-12.34” as a word. To prevent that from happening, a period and a minus are stripped of their numeric character with the method `ordinaryChar()`. Also, a dollar sign and an underscore are included with `wordChars()` among the characters that can constitute a Java identifier. Because a period and a minus are demoted to the level of ordinary characters, the stream tokenizer recognizes as numbers only sequences of digits. To deal with floating-point numbers, one number has to be put together by the interpreter from two such sequences and a period between them, which is done in `factor()`.

Figure 5.20 contains the complete code for our interpreter.

**FIGURE 5.20** Implementation of a simple language interpreter.

```

import java.io.*;

class Id {
    private String id;
    public double value;
    public Id(String s, double d) {
        id = s; value = d;
    }
    public boolean equals(Object node) {
        return id.equals(((Id)node).id);
    }
    public String toString() {
        return id + " = " + value + "; ";
    }
}

public class Interpreter {
    private StreamTokenizer fIn = new StreamTokenizer(
        new BufferedReader(
            new InputStreamReader(System.in)));
    private java.util.LinkedList idList = new java.util.LinkedList();
    public Interpreter() {
        fIn.wordChars('$','$');// include underscores and dollar signs as
        fIn.wordChars('_', '_');// word constituents; examples of identifiers:
            // var1, x, _pqr123xyz, $aName;
        fIn.ordinaryChar('/');// by default, '/' is a comment character;
        fIn.ordinaryChar('.');// otherwise "n-123.45"
        fIn.ordinaryChar('-');// is considered a token;
    }
    private void issueError(String s) {
        System.out.println(s);
        Runtime.getRuntime().exit(-1);
    }
    private void addOrModify(String id, double e) {
        Id tmp = new Id(new String(id),e);
        int pos;
        if ((pos = idList.indexOf(tmp)) != -1)
            ((Id)idList.get(pos)).value = e;
        else idList.add(tmp);
    }
}

```

*Continues*

**FIGURE 5.20** (continued)

```

private double findValue(String id) {
    int pos;
    if ((pos = idList.indexOf(new Id(id,0.0))) != -1)
        return ((Id)idList.get(pos)).value;
    else issueError("Unknown variable " + id);
    return 0.0; // this statement is never reached;
}
private double factor() throws IOException {
    double val, minus = 1.0;
    fIn.nextToken();
    while (fIn.ttype == '+' || fIn.ttype == '-') { // take all '+'s
        if (fIn.ttype == '-') // and '-'s;
            minus *= -1.0;
        fIn.nextToken();
    }
    if (fIn.ttype == fIn.TT_NUMBER || fIn.ttype == '.') {
        if (fIn.ttype == fIn.TT_NUMBER) { // factor can be a number:
            val = fIn.nval; // 123, .123, 123., 12.3;
            fIn.nextToken();
        }
        else val = 0;
        if (fIn.ttype == '.') {
            fIn.nextToken();
            if (fIn.ttype == fIn.TT_NUMBER) {
                String s = fIn.nval + "";
                s = "." + s.substring(0,s.indexOf('.'));
                val += Double.valueOf(s).doubleValue();
            }
            else fIn.pushBack();
        }
        else fIn.pushBack();
    }
    else if (fIn.ttype == '(') { // or a parenthesized
        val = expression(); // expression,
        if (fIn.ttype == ')')
            fIn.nextToken();
        else issueError("Right parenthesis is left out.");
    }
    else {
        val = findValue(fIn.sval); // or an identifier;
    }
}

```

**FIGURE 5.20** (continued)

```

        return minus*val;
    }
    private double term() throws IOException {
        double f = factor();
        while (true) {
            fIn.nextToken();
            switch (fIn.ttype) {
                case '*' : f *= factor(); break;
                case '/' : f /= factor(); break;
                default : fIn.pushBack(); return f;
            }
        }
    }
    private double expression() throws IOException {
        double t = term();
        while (true) {
            fIn.nextToken();
            switch (fIn.ttype) {
                case '+' : t += term(); break;
                case '-' : t -= term(); break;
                default : fIn.pushBack(); return t;
            }
        }
    }
    public void run() {
        try {
            System.out.println("The program processes statements in the "
                + "following format:\n"
                + "\t<id> = <expr>;\n\tprint <id>\n\tstatus\n\tend");
            while (true) {
                System.out.print("Enter a statement: ");
                fIn.nextToken();
                String str = fIn.sval;
                if (str.toUpperCase().equals("STATUS")) {
                    java.util.Iterator it = idList.iterator();
                    while (it.hasNext())
                        System.out.println(it.next());
                }
                else if (str.toUpperCase().equals("PRINT")) {
                    fIn.nextToken();

```

*Continues*

**FIGURE 5.20** (continued)

```
        str = fIn.sval;
        System.out.println(str + " = " + findValue(str));
    }
    else if (str.toUpperCase().equals("END"))
        return;
    else {
        fIn.nextToken();
        if (fIn.ttype == '=') {
            double e = expression();
            fIn.nextToken();
            if (fIn.ttype != ';')
                issueError("There are some extras in the
                    statement.");
            else addOrModify(str,e);
        }
        else issueError("'=' is missing.");
    }
}
} catch (IOException e) {
    e.printStackTrace();
}
}
public static void main(String args[]) {
    (new Interpreter()).run();
}
}
```



## 5.12

## EXERCISES

- The set of natural numbers  $\mathbf{N}$  defined at the beginning of this chapter includes the numbers 10, 11, . . . , 20, 21, . . . , and also the numbers 00, 000, 01, 001, . . . . Modify this definition to allow only numbers with no leading zeros.
- Write a recursive method that calculates and returns the length of a linked list.
- What is the output for the following version of `reverse()`:

```
void reverse() {
    int ch = getChar();
    if (ch != '\n')
        reverse();
    System.out.print(ch);
}
```

- Write a recursive method that for a positive integer  $n$  prints odd numbers
  - between 1 and  $n$
  - between  $n$  and 1
- Write a recursive method that for a positive integer returns a string with commas in the appropriate places, for example, `putCommas(1234567)` returns the string "1,234,567."
- Write a recursive method to print a *Syracuse sequence* that begins with a number  $n_0$  and each element  $n_i$  of the sequence is  $n_{i-1}/2$  if  $n_i$  is even and  $3n + 1$  otherwise. The sequence ends with 1.
- Write a recursive method that uses only addition, subtraction, and comparison to multiply two numbers.
- Write a recursive method to compute the binomial coefficient according to the definition

$$\binom{n}{k} = \begin{cases} 1 & \text{if } k = 0 \text{ or } k = n \\ \binom{n-1}{k-1} + \binom{n-1}{k} & \text{otherwise} \end{cases}$$

- Write a recursive method to add the first  $n$  terms of the series

$$1 + \frac{1}{2} - \frac{1}{3} + \frac{1}{4} - \frac{1}{5} \dots$$

- Write a recursive method `GCD(n, m)` that returns the greatest common divisor of two integers  $n$  and  $m$  according to the following definition:

$$\text{GCD}(n, m) = \begin{cases} m & \text{if } m \leq n \text{ and } n \bmod m = 0 \\ \text{GCD}(m, n) & \text{if } n < m \\ \text{GCD}(m, n \bmod m) & \text{otherwise} \end{cases}$$

11. Give a recursive version of the following method:

```
void cubes (int n) {
    for (int i = 1; i <=n; i++)
        System.out.print (i * i * i + "");
}
```

12. An early application of recursion can be found in the seventeenth century in John Napier's method of finding logarithms. The method was as follows:

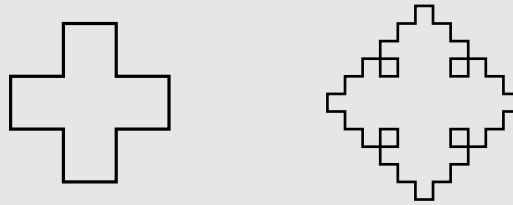
*start with two numbers  $n$ ,  $m$  and their logarithms  $\log n$ ,  $\log m$  if they are known;*  
*while not done*  
*for a geometric mean of two earlier numbers find a logarithm which is an arithmetic mean of two earlier logarithms, that is,  $\log k = (\log n + \log m) / 2$  for  $k = \sqrt{nm}$ ;*  
*proceed recursively for pairs  $(n, \sqrt{nm})$  and  $(\sqrt{nm}, m)$ ;*

For example, the 10-based logarithms of 100 and 1,000 are numbers 2 and 3, the geometric mean of 100 and 1,000 is 316.23, and the arithmetic mean of their logarithms, 2 and 3, is 2.5. Thus, the logarithm of 316.23 equals 2.5. The process can be continued: The geometric mean of 100 and 316.23 is 177.83, whose logarithm is equal to  $(2 + 2.5) / 2 = 2.25$ .

- a. Write a recursive method `logarithm()` that outputs logarithms until the difference between adjacent logarithms is smaller than a certain small number.
  - b. Modify this method so that a new method `logarithmOf()` finds a logarithm of a specific number  $x$  between 100 and 1,000. Stop processing if you reach a number  $y$  such that  $y - x < \epsilon$  for some  $\epsilon$ .
  - c. Add a method that calls `logarithmOf()` after determining between what powers of 10 a number  $x$  falls so that it does not have to be a number between 100 and 1,000.
13. The algorithms for both versions of the power function given in this chapter are rather simpleminded. Is it really necessary to make eight multiplications to compute  $x^8$ ? It can be observed that  $x^8 = (x^4)^2$ ,  $x^4 = (x^2)^2$ , and  $x^2 = x \cdot x$ ; that is, only three multiplications are needed to find the value of  $x^8$ . Using this observation, improve both algorithms for computing  $x^n$ . Hint: A special case is needed for odd exponents.
14. Execute by hand the methods `tail()` and `nonTail()` for the parameter values of 0, 2, and 4. Definitions of these methods are given in Section 5.4.
15. Check recursively if the following objects are palindromes:
- a. a word
  - b. a sentence (ignoring blanks, lower- and uppercase differences, and punctuation marks so that "Madam, I'm Adam" is accepted as a palindrome)
16. For a given character recursively,
- a. Check if it is in a string.
  - b. Count all of its occurrences in a string.
  - c. Remove all of its occurrences from a string.
17. Write equivalents of the last three methods for substrings.

18. What changes would have to be made in the method presented in Figure 5.6 to draw a line as in Figure 5.21? Try it, and experiment with other possibilities to generate other curves.

**FIGURE 5.21** Lines to be drawn with modified program in Figure 5.6.



19. Create a tree of calls for  $\sin(x)$  assuming that only  $\frac{x}{18}$  (and smaller values) do not trigger other calls.
20. Write recursive and nonrecursive methods to print out a nonnegative integer in binary. The methods should not use bitwise operations.
21. The nonrecursive version of the method for computing Fibonacci numbers uses information accumulated during computation, whereas the recursive version does not. However, it does not mean that no recursive implementation can be given that can collect the same information as the nonrecursive counterpart. In fact, such an implementation can be obtained directly from the nonrecursive version. What would it be? Consider using two methods instead of one; one would do all the work, and the other would only invoke it with the proper parameters.
22. The method `putQueen()` does not recognize that certain configurations are symmetric. Adapt method `putQueen()` for a full  $8 \times 8$  chessboard, write the method `printBoard()`, and run a program for solving the eight queens problem so that it does not print symmetric solutions.
23. Finish the trace of execution of `putQueen()` shown in Figure 5.18.
24. Execute the following program by hand from the case study, using these two entries:
- $v = x + y * w - z$
  - $v = x * (y - w) --z$
- Indicate clearly which methods are called at which stage of parsing these sentences.
25. Extend our interpreter so that it can also process exponentiation,  $\wedge$ . Remember that exponentiation has precedence over all other operations so that  $2 - 3^4 * 5$  is the same as  $2 - ((3^4) * 5)$ . Notice also that exponentiation is a right-associative operator (unlike addition and subtraction); that is,  $2^3^4$  is the same as  $2^{\wedge}(3^4)$  and not  $(2^3)^4$ .

26. In Java, the division operator, /, returns an integer result when it is applied to two integers; for instance, 11/5 equals 2. However, in our interpreter, the result is 2.2. Modify this interpreter so that division works the same way as in Java.
27. Our interpreter is unforgiving when a mistake is made by the user, because it finishes execution if a problem is detected. For example, when the name of a variable is mistyped when requesting its value, the program notifies the user and exits and destroys the list of identifiers. Modify the program so that it continues execution after finding an error.
28. Write the shortest program you can that uses recursion.

## 5.13

## PROGRAMMING ASSIGNMENTS

1. Compute the standard deviation  $\sigma$  for  $n$  values  $x_k$  stored in an array `data` and for the equal probabilities  $\frac{1}{n}$  associated with them. The standard deviation is defined as

$$\sigma = \sqrt{V}$$

where the variance,  $V$ , is defined by

$$V = \frac{1}{n-1} \sum_k (x_k - \bar{x})^2$$

and the mean,  $\bar{x}$ , by

$$\bar{x} = \frac{1}{n} \sum_k x_k$$

Write recursive and iterative versions of both  $V$  and  $\bar{x}$  and compute the standard deviation using both versions of the mean and variance. Run your program for  $n = 500$ , 1,000, 1,500, and 2,000 and compare the run times.

2. Write a program to do symbolic differentiation. Use the following formulas:

$$\text{Rule 1: } (fg)' = fg' + f'g$$

$$\text{Rule 2: } (f + g)' = f' + g'$$

$$\text{Rule 3: } \left(\frac{f}{g}\right)' = \frac{f'g - fg'}{g^2}$$

$$\text{Rule 4: } (ax^n)' = nax^{n-1}$$

An example of application of these rules is given below with differentiation with respect to  $x$ :

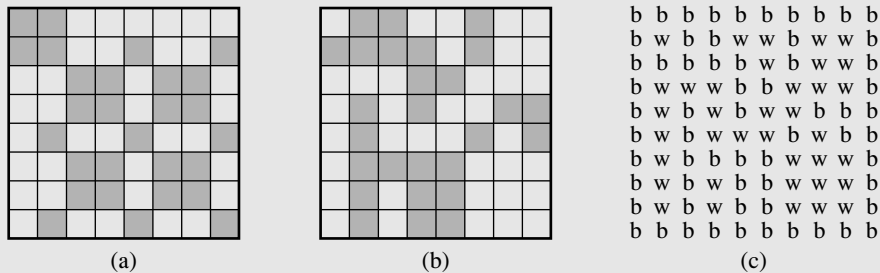
$$\begin{aligned} & \left(5x^3 + \frac{6x}{y} - 10x^2y + 100\right)' \\ &= (5x^3)' + \left(\frac{6x}{y}\right)' + (-10x^2y)' + (100)' && \text{by Rule 2} \\ &= 15x^2 + \left(\frac{6x}{y}\right)' + (-10x^2y)' && \text{by Rule 4} \\ &= 15x^2 + \frac{(6x)'y - (6x)y'}{y^2} + (-10x^2y)' && \text{by Rule 3} \\ &= 15x^2 + \frac{6y}{y^2} + (-10x^2y)' && \text{by Rule 4} \end{aligned}$$

$$\begin{aligned}
 &= 15x^2 + \frac{6y}{y^2} + (-10x^2)y' + (-10x^2)'y && \text{by Rule 1} \\
 &= 15x^2 + \frac{6}{y} - 20xy && \text{by Rule 4}
 \end{aligned}$$

First, run your program for polynomials only, and then add formulas for derivatives for trigonometric functions, logarithms, and so on, that extend the range of functions handled by your program.

3. An  $n \times n$  square consists of black and white cells arranged in a certain way. The problem is to determine the number of white areas and the number of white cells in each area. For example, a regular  $8 \times 8$  chessboard has 32 one-cell white areas; the square in Figure 5.22a consists of 10 areas, 2 of them of 10 cells, and 8 of 2 cells; the square in Figure 5.22b has 5 white areas of 1, 3, 21, 10, and 2 cells.

**FIGURE 5.22** (a–b) Two  $n \times n$  squares of black and white cells and (c) an  $(n + 2) \times (n + 2)$  array implementing square (b).



Write a program that, for a given  $n \times n$  square, outputs the number of white areas and their sizes. Use an  $(n + 2) \times (n + 2)$  array with properly marked cells. Two additional rows and columns constitute a frame of black cells surrounding the entered square to simplify your implementation. For instance, the square in Figure 5.22b is stored as the square in Figure 5.22c.

Traverse the square row by row and, for the first unvisited cell encountered, invoke a method that processes one area. The secret is in using four recursive calls in this method for each unvisited white cell and marking it with a special symbol as visited (counted).

4. Write a program for *pretty printing* Java programs; that is, for printing programs with consistent use of indentation, the number of spaces between tokens such as key words, parentheses, brackets, operators, the number of blank lines between blocks of code (classes, methods, etc.), aligning braces with key words, aligning `else` statements with the corresponding `if` statements, and so on. The program takes as input a Java file and prints code in this file according to the rules incorporated in the pretty printing program. For example, the code

```

if (n == 1) { n = 2 * m;
if (m < 10)
objectA.methodA (n,m-1); else objectA.methodA (n,m-2); } else n = 3 * m;

```

should be transformed into

```

if (n == 1) {
    n = 2 * m;
    if (m < 10)
        objectA.methodA (n,m-1);
    else objectA.methodA (n,m-2);
}
else n = 3 * m;

```

5. An excellent example of a program that can be greatly simplified by the use of recursion is the Chapter 4 case study, escaping a maze. As already explained, in each maze cell the mouse stores on the maze stack up to four cells neighboring the cell in which it is currently located. The cells put on the stack are the ones that should be investigated after reaching a dead end. It does the same for each visited cell. Write a program that uses recursion to solve the maze problem. Use the following pseudocode:

```

exitCell(currentCell)
    if currentCell is the exit
        success;
    else exitCell(the passage above currentCell);
        exitCell(the passage below currentCell);
        exitCell(the passage left to currentCell);
        exitCell(the passage right to currentCell);

```

## BIBLIOGRAPHY

### *Recursion and Applications of Recursion*

Barron, David W., *Recursive Techniques in Programming*, New York: Elsevier, 1975.

Berlioux, Pierre, and Bizard, Philippe, *Algorithms: The Construction, Proof, and Analysis of Programs*, New York: Wiley, 1986, Chs. 4–6.

Bird, Richard S., *Programs and Machines*, New York: Wiley, 1976.

Burge, William H., *Recursive Programming Techniques*, Reading, MA: Addison-Wesley, 1975.

Lorentz, Richard, *Recursive Algorithms*, Norwood, NJ: Ablex, 1994.

Roberts, Eric, *Thinking Recursively*, New York: Wiley, 1986.

Rohl, Jeffrey S., *Recursion via Pascal*, Cambridge: Cambridge University Press, 1984.

***Transformations between Recursion and Iteration***

Auslander, M. A., and Strong, H. R., "Systematic Recursion Removal," *Communications of the ACM* 21 (1978), 127–134.

Bird, R. S., "Notes on Recursion Elimination," *Communications of the ACM* 20 (1977), 434–439.

Dijkstra, Edsger W., "Recursive Programming," *Numerische Mathematik* 2 (1960), 312–318.

***Algorithm to Solve the Eight Queens Problem***

Wirth, Niklaus, *Algorithms and Data Structures*, Englewood Cliffs, NJ: Prentice Hall, 1986.

# 6

# Binary Trees

## 6.1 TREES, BINARY TREES, AND BINARY SEARCH TREES

Linked lists usually provide greater flexibility than arrays, but they are linear structures and it is difficult to use them to organize a hierarchical representation of objects. Although stacks and queues reflect some hierarchy, they are limited to only one dimension. To overcome this limitation, we create a new data type called a *tree* that consists of *nodes* and *arcs*. Unlike natural trees, these trees are depicted upside down with the *root* at the top and the *leaves* (*terminal nodes*) at the bottom. The root is a node that has no parent; it can have only child nodes. Leaves, on the other hand, have no children, or rather, their children are null. A tree can be defined recursively as the following:

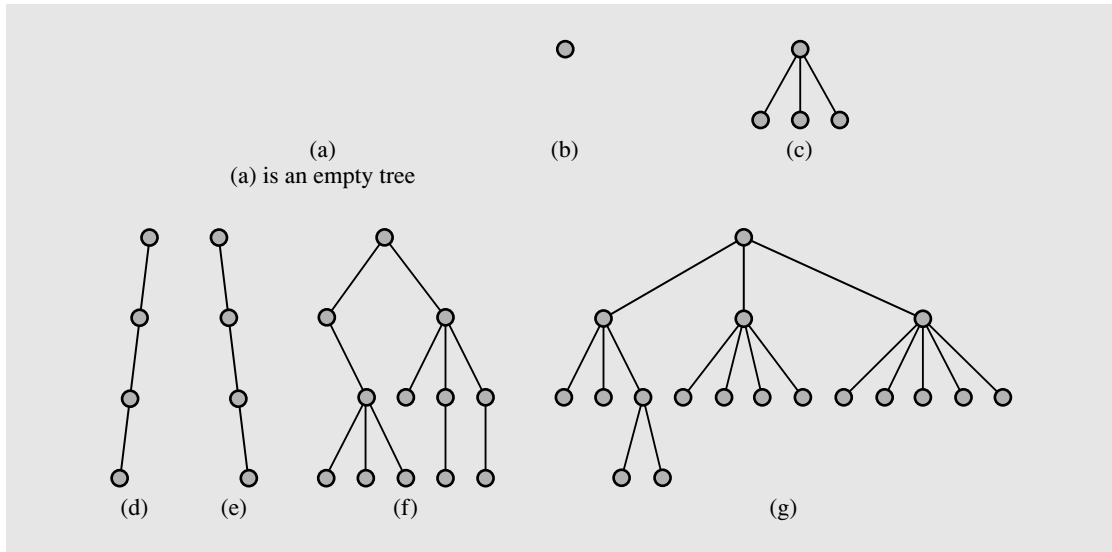
1. An empty structure is an empty tree.
2. If  $t_1, \dots, t_k$  are disjoint trees, then the structure whose root has as its children the roots of  $t_1, \dots, t_k$  is also a tree.
3. Only structures generated by rules 1 and 2 are trees.

Figure 6.1 contains examples of trees. Each node has to be reachable from the root through a unique sequence of arcs, called a *path*. The number of arcs in a path is called the *length* of the path. The *level* of a node is the length of the path from the root to the node plus 1, which is the number of nodes in the path. The *height* of a non-empty tree is the maximum level of a node in the tree. The empty tree is a legitimate tree of height 0 (by definition), and a single node is a tree of height 1. This is the only case in which a node is both the root and a leaf. The level of a node must be between 1 (the level of the root) and the height of the tree, which in the extreme case is the level of the only leaf in a degenerate tree resembling a linked list.

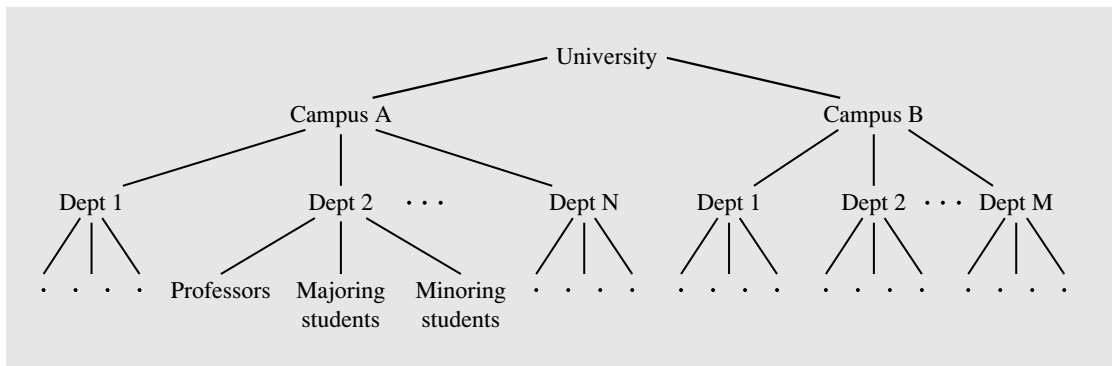
Figure 6.2 contains an example of a tree that reflects the hierarchy of a university. Other examples are genealogical trees, trees reflecting the grammatical structure of sentences, and trees showing the taxonomic structure of organisms, plants, or characters. Virtually all areas of science make use of trees to represent hierarchical structures.



**FIGURE 6.1** Examples of trees.



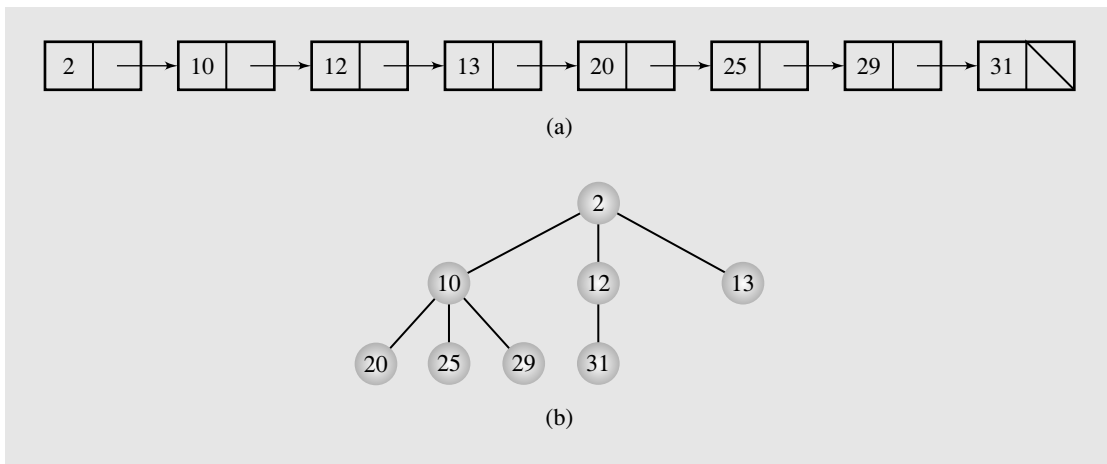
**FIGURE 6.2** Hierarchical structure of a university shown as a tree.



The definition of a tree does not impose any condition on the number of children of a given node. This number can vary from 0 to any integer. In hierarchical trees, this is a welcome property. For example, the university has only two branches, but each campus can have a different number of departments. Such trees are used in database management systems, especially in the hierarchical model. But representing hierarchies is not the only reason for using trees. In fact, in the discussion to follow, that aspect of trees is treated rather lightly, mainly in the discussion of expression trees. This chapter focuses on tree operations that allow us to accelerate the search process.

Consider a linked list of  $n$  elements. To locate an element, the search has to start from the beginning of the list, and the list must be scanned until the element is found or the end of the list is reached. Even if the list is ordered, the search of the list always has to start from the first node. Thus, if the list has 10,000 nodes and the information in the last node is to be accessed, then all 9,999 of its predecessors have to be traversed, an obvious inconvenience. If all the elements are stored in an *orderly tree*, a tree where all elements are stored according to some predetermined criterion of ordering, the number of tests can be reduced substantially even when the element to be located is the one furthest away. For example, the linked list in Figure 6.3a can be transformed into the tree in Figure 6.3b.

**FIGURE 6.3** Transforming (a) a linked list into (b) a tree.



Was a reasonable criterion of ordering applied to construct this tree? To test whether 31 is in the linked list, eight tests have to be performed. Can this number be reduced further if the same elements are ordered from top to bottom and from left to right in the tree? What would an algorithm be like that forces us to make three tests only: one for the root, 2; one for its middle child, 12; and one for the only child of this child, 31? The number 31 could be located on the same level as 12, or it could be a child of 10. With this ordering of the tree, nothing really interesting is achieved in the context of searching. (The heap discussed later in this chapter uses this approach.) Consequently, a better criterion must be chosen.

Again, note that each node can have any number of children. In fact, there are algorithms developed for trees with a deliberate number of children (see the next chapter), but this chapter discusses only binary trees. A *binary tree* is a tree whose nodes have two children (possibly empty), and each child is designated as either a left child or a right child. For example, the trees in Figure 6.4 are binary trees, whereas the university tree in

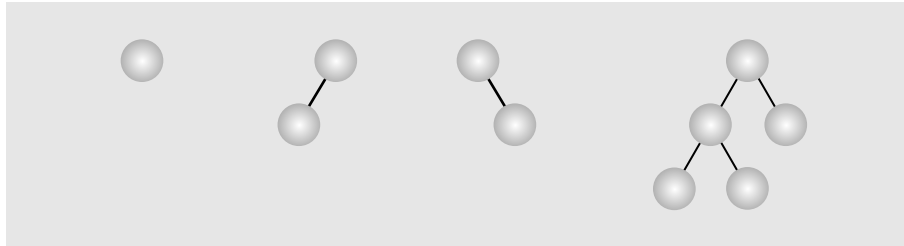
**FIGURE 6.4** Examples of binary trees.

Figure 6.2 is not. An important characteristic of binary trees, which is used later in assessing an expected efficiency of sorting algorithms, is the number of leaves.

As already defined, the level of a node is the number of arcs traversed from the root to the node plus one. According to this definition, the root is at level 1, its immediate children are at level 2, and so on. If all the nodes at all levels except the last had two nonnull children, then there would be  $1 = 2^0$  node at level 1,  $2 = 2^1$  nodes at level 2,  $4 = 2^2$  nodes at level 3, and generally,  $2^i$  nodes at level  $i + 1$ . A tree satisfying this condition is referred to as a *complete binary tree*. In this tree, all nonterminal nodes have both their children, and all leaves are at the same level. Consequently, in all binary trees, there are at most  $2^i$  nodes at level  $i + 1$ . In Chapter 9, we calculate the number of leaves in a *decision tree*, which is a binary tree in which all nodes have either zero or two nonempty children. Because leaves can be interspersed throughout a decision tree and appear at each level except level 1, no generally applicable formula can be given to calculate the number of nodes because it may vary from tree to tree. But the formula can be approximated by noting first that

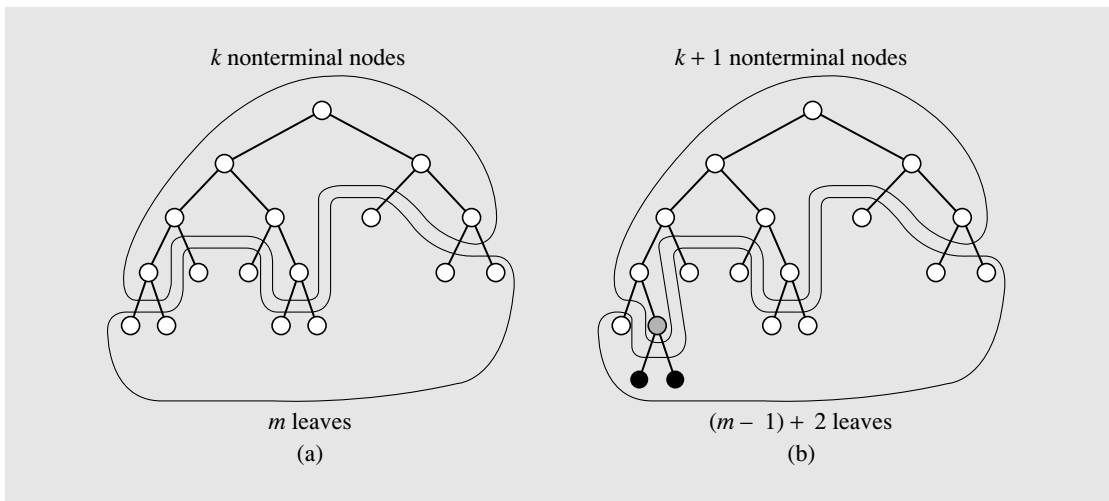
For all the nonempty binary trees whose nonterminal nodes have exactly two nonempty children, the number of leaves  $m$  is greater than the number of nonterminal nodes  $k$  and  $m = k + 1$ .

If a tree has only a root, this observation holds trivially. If it holds for a certain tree, then after attaching two leaves to one of the already existing leaves, this leaf turns into a nonterminal node, whereby  $m$  is decremented by 1 and  $k$  is incremented by 1. However, because two new leaves have been grafted onto the tree,  $m$  is incremented by 2. After these two increments and one decrement, the equation  $(m - 1) + 2 = (k + 1) + 1$  is obtained and  $m = k + 1$ , which is exactly the result aimed at (see Figure 6.5). It implies that an  $i + 1$ -level complete decision tree has  $2^i$  leaves, and due to the preceding observation, it also has  $2^i - 1$  nonterminal nodes, which makes  $2^i + 2^i - 1 = 2^{i+1} - 1$  nodes in total (see also Figure 6.35).

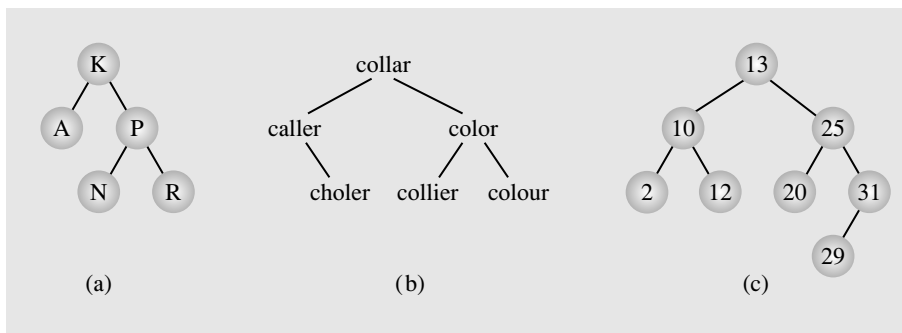
In this chapter, the *binary search trees*, also called *ordered binary trees*, are of particular interest. A binary search tree has the following property: For each node  $n$  of the tree, all values stored in its left subtree (the tree whose root is the left child) are less than value  $v$  stored in  $n$ , and all values stored in the right subtree are greater than  $v$ .

For reasons to be discussed later, storing multiple copies of the same value in the same tree is avoided. An attempt to do so can be treated as an error. The meanings of “less than” or “greater than” depend on the type of values stored in the tree: It is “<” and “>” for numerical values and alphabetical order in the case of strings. The trees in Figure 6.6 are binary search trees. Note that Figure 6.6c contains a tree with the same data as the linked list in Figure 6.3a whose searching was to be optimized.

**FIGURE 6.5** Adding a leaf to tree (a), preserving the relation of the number of leaves to the number of nonterminal nodes (b).



**FIGURE 6.6** Examples of binary search trees.



## 6.2 IMPLEMENTING BINARY TREES

Binary trees can be implemented in at least two ways: as arrays and as linked structures. To implement a tree as an array, a node is declared as an object with an information field and two “reference” fields. These reference fields contain the indexes of the array cells in which the left and right children are stored, if there are any. For example, the tree from Figure 6.6c can be represented as the array in Figure 6.7. The root is always located in the first cell, cell 0, and  $-1$  indicates a null child. In this representation, the two children of node 13 are located in positions 4 and 2, and the right child of node 31 is null.

**FIGURE 6.7** Array representation of the tree in Figure 6.6c.

Index	Info	Left	Right
0	13	4	2
1	31	6	-1
2	25	7	1
3	12	-1	-1
4	10	5	3
5	2	-1	-1
6	29	-1	-1
7	20	-1	-1

However, this implementation may be inconvenient, even if the array is flexible—that is, a vector or an array list. Locations of children must be known to insert a new node, and these locations may need to be located sequentially. After deleting a node from the tree, a hole in the array would have to be eliminated. This can be done either by using a special marker for an unused cell, which may lead to populating the array with many unused cells, or by moving elements by one position, which also requires updating references to the elements that have been moved. Sometimes an array implementation is convenient and desirable, and it will be used when discussing the heap sort. But usually, another approach needs to be used.

In the new implementation, only trees of integers are discussed. The use of a generic tree (that is, a tree for storing any type of data) is illustrated in the case study at the end of this chapter.

In the new implementation, a node is an instance of a class composed of an information field and two reference fields. This node is used and operated on by methods in another class that pertains to the tree as a whole (see Figure 6.8).

**FIGURE 6.8** Implementation of a generic binary search tree.

```

/***** IntBSTNode.java *****/
*
*      binary search tree of integers
*/

public class IntBSTNode {
    protected int key;
    protected IntBSTNode left, right;
    public IntBSTNode() {
        left = right = null;
    }
    public IntBSTNode(int e1) {
        this(e1, null, null);
    }
    public IntBSTNode(int e1, IntBSTNode lt, IntBSTNode rt) {
        key = e1; left = lt; right = rt;
    }
}

/***** IntBST.java *****/
*
*      binary search tree of integers
*/

public class IntBST {
    protected IntBSTNode root;
    public IntBST() {
        root = null;
    }
    protected void visit(IntBSTNode p) {
        System.out.print(p.key + " ");
    }
    public IntBSTNode search(IntBSTNode p, int e1) {
        return search(p, root);
    }
    public IntBSTNode search(IntBSTNode p, int e1) { . . . } // Figure 6.9
    public void breadthFirst() { . . . } // Figure 6.10
    public void preorder() {
        preorder(root);
    }
    protected void preorder(IntBSTNode p) { . . . } // Figure 6.11
    public void inorder() {

```

**FIGURE 6.8** (continued)

```

        inorder(root);
    }
    protected void inorder(IntBSTNode p) { . . . }           // Figure 6.11
    public void postorder() {
        postorder(root);
    }
    protected void postorder(IntBSTNode p) { . . . }       // Figure 6.11
    public void iterativePreorder() { . . . }             // Figure 6.15
    public void iterativeInorder() { . . . }              // Figure 6.17
    public void iterativePostorder() { . . . }           // Figure 6.16
    public void MorrisInorder() { . . . }                // Figure 6.20
    public void insert(int el) { . . . }                  // Figure 6.23
    public void deleteByMerging(int el) { . . . }        // Figure 6.29
    public void deleteByCopying(int el) { . . . }        // Figure 6.32
    public void balance (int data[], int first, int last) // Section 6.7
    . . . . .
    }

```

## 6.3 SEARCHING A BINARY SEARCH TREE

An algorithm for locating an element in this tree is quite straightforward, as indicated by its implementation in Figure 6.9. For every node, compare the key to be located with the value stored in the node currently referred. If the key is less than the value, go to the left subtree and try again. If it is greater than that value, try the right subtree. If it is the same, obviously the search can be discontinued. The search is also aborted if there is no way to go, indicating that the key is not in the tree. For example, to locate the number 31 in the tree in Figure 6.6c, only three tests are performed. First, the tree is checked to see if the number is in the root node. Next, because 31 is greater than 13, the root's right child containing the value 25 is tried. Finally, because 31 is again greater than the value of the currently tested node, the right child is tried again, and the value 31 is found.

The worst case for this binary tree is when it is searched for the numbers 26, 27, 28, 29, or 30 because those searches each require four tests (why?). In the case of all other integers, the number of tests is fewer than four. It can now be seen why an element should only occur in a tree once. If it occurs more than once, then two approaches are possible. One approach locates the first occurrence of an element and disregards the others. In this case, the tree contains redundant nodes that are never used for their own sake; they are accessed only for testing. In the second approach, all occurrences of an element may have to be located. Such a search always has to finish with a leaf. For example, to locate all instances of 13 in the tree, the root node 13 has to be tested, then its right child 25, and finally the node 20. The search proceeds along

**FIGURE 6.9** A function for searching a binary search tree.

```

public IntBSTNode search(IntBSTNode p, int el) {
    while (p != null)
        if (el == p.key)
            return p;
        else if (el < p.key)
            p = p.left;
        else p = p.right;
    return null;
}

```

the worst-case scenario: when the leaf level has to be reached in expectation that some more occurrences of the desired element can be encountered.

The complexity of searching is measured by the number of comparisons performed during the searching process. This number depends on the number of nodes encountered on the unique path leading from the root to the node being searched for. Therefore, the complexity is the length of the path leading to this node plus 1. Complexity depends on the shape of the tree and the position of the node in the tree.

The *internal path length (IPL)* is the sum of all path lengths of all nodes, which is calculated by summing  $\sum (i-1)l_i$  over all levels  $i$ , where  $l_i$  is the number of nodes on level  $i$ . A depth of a node in the tree is determined by the path length. An average depth, called an *average path length*, is given by the formula  $IPL/n$ , which depends on the shape of the tree. In the worst case, when the tree turns into a linked list,  $path_{worst} = \frac{1}{n} \sum_{i=1}^n (i-1) = \frac{n-1}{2} = O(n)$ , and a search can take  $n$  time units.

The best case occurs when all leaves in the tree of height  $h$  are in at most two levels, and only nodes in the next to last level can have one child. To simplify the computation, we approximate the average path length for such a tree,  $path_{best}$ , by the average path of a complete binary tree of the same height.

By looking at simple examples, we can determine that for the complete binary tree of height  $h$ ,  $IPL = \sum_{i=1}^{h-1} i2^i$ . From this and from the fact that  $\sum_{i=1}^{h-1} 2^i = 2^h - 2$ , we have

$$IPL = 2IPL - IPL = (h-1)2^h - \sum_{i=1}^{h-1} 2^i = (h-2)2^h + 2$$

As has already been established, the number of nodes in the complete binary tree  $n = 2^h - 1$ , so

$$path_{best} = IPL/n = \left( (h-2)2^h + 2 \right) / (2^h - 1) \approx h - 2$$

which is in accordance with the fact that, in this tree, one-half of the nodes are in the leaf level with path length  $h-1$ . Also, in this tree, the height  $h = \lg(n+1)$ , so  $path_{best} = \lg(n+1) - 2$ ; the average path length in a perfectly balanced tree is  $\lceil \lg(n+1) \rceil - 2 = O(\lg n)$  where  $\lceil x \rceil$  is the closest integer greater than  $x$ .



The average case in an average tree is somewhere between  $\frac{n-1}{2}$  and  $\lg(n+1) - 2$ . Is a search for a node in an average position in a tree of average shape closer to  $O(n)$  or  $O(\lg n)$ ? First, the average shape of the tree has to be represented computationally.

The root of a binary tree can have an empty left subtree and a right subtree with all  $n - 1$  nodes. It also can have one node in the left subtree and  $n - 2$  nodes in the right, and so on. Finally, it can have an empty right subtree with all remaining nodes in the left. The same reasoning can be applied to both subtrees of the root, to the subtrees of these subtrees, down to the leaves. The average internal path length is the average over all these differently shaped trees.

Assume that the tree contains nodes 1 through  $n$ . If  $i$  is the root, then its left subtree has  $i - 1$  nodes, and its right subtree has  $n - i$  nodes. If  $path_{i-1}$  and  $path_{n-i}$  are average paths in these subtrees, then the average path of this tree is

$$path_n(i) = ((i-1)(path_{i-1} + 1) + (n-i)(path_{n-i} + 1))/n$$

Assuming that elements are coming randomly to the tree, the root of the tree can be any number  $i$ ,  $1 \leq i \leq n$ . Therefore, the average path of an average tree is obtained by averaging all values of  $path_n(i)$  over all values of  $i$ . This gives the formula

$$\begin{aligned} path_n &= \frac{1}{n} \sum_{i=1}^n path_n(i) = \frac{1}{n^2} \sum_{i=1}^n ((i-1)(path_{i-1} + 1) + (n-i)(path_{n-i} + 1)) \\ &= \frac{2}{n^2} \sum_{i=1}^{n-1} i(path_i + 1) \end{aligned}$$

from which, and from  $path_1 = 0$ , we obtain  $2 \ln n = 2 \ln 2 \lg n = 1.386 \lg n$  as an approximation for  $path_n$  (see Section A.4 in Appendix A). This is an approximation for the average number of comparisons in an average tree. This number is  $O(\lg n)$ , which is closer to the best case than to the worst case. This number also indicates that there is little room for improvement, because  $path_{best}/path_n \approx .7215$ , and the average path length in the best case is different by only 27.85% from the expected path length in the average case. Searching in a binary tree is, therefore, very efficient in most cases, even without balancing the tree. However, this is true only for randomly created trees because, in highly unbalanced and elongated trees whose shapes resemble linked lists, search time is  $O(n)$ , which is unacceptable considering that  $O(\lg n)$  efficiency can be achieved.

## 6.4 TREE TRAVERSAL

*Tree traversal* is the process of visiting each node in the tree exactly one time. Traversal may be interpreted as putting all nodes on one line or linearizing a tree.

The definition of traversal specifies only one condition—visiting each node only one time—but it does not specify the order in which the nodes are visited. Hence, there are as many tree traversals as there are permutations of nodes; for a tree with  $n$  nodes, there are  $n!$  different traversals. Most of them, however, are rather chaotic and do not indicate much regularity so that implementing such traversals lacks generality: For each  $n$ , a separate set of traversal procedures must be implemented, and only a few of them can be used for a different number of data. For example, two possible traversals of the tree in Figure 6.6c that may be of some use are the sequence 2, 10, 12, 20, 13, 25,

29, 31 and the sequence 29, 31, 20, 12, 2, 25, 10, 13. The first sequence lists even numbers and then odd numbers in ascending order. The second sequence lists all nodes from level to level right to left, starting from the lowest level up to the root. The sequence 13, 31, 12, 2, 10, 29, 20, 25 does not indicate any regularity in the order of numbers or in the order of the traversed nodes. It is just a random jumping from node to node that in all likelihood is of no use. Nevertheless, all these sequences are the results of three legitimate traversals out of  $8! = 40,320$ . In the face of such an abundance of traversals and the apparent uselessness of most of them, we would like to restrict our attention to two classes only, namely, breadth-first and depth-first traversals.

### 6.4.1 Breadth-First Traversal

*Breadth-first traversal* is visiting each node starting from the lowest (or highest) level and moving down (or up) level by level, visiting nodes on each level from left to right (or from right to left). There are thus four possibilities, and one such possibility—a top-down, left-to-right, breadth-first traversal of the tree in Figure 6.6c—results in the sequence 13, 10, 25, 2, 12, 20, 31, 29.

Implementation of this kind of traversal is straightforward when a queue is used. Consider a top-down, left-to-right, breadth-first traversal. After a node is visited, its children, if any, are placed at the end of the queue, and the node at the beginning of the queue is visited. Considering that for a node on level  $n$ , its children are on level  $n + 1$ , by placing these children at the end of the queue, they are visited after all nodes from level  $n$  are visited. Thus, the restriction that all nodes on level  $n$  must be visited before visiting any nodes on level  $n + 1$  is accomplished.

An implementation of the corresponding method is shown in Figure 6.10.

**FIGURE 6.10** Top-down, left-to-right, breadth-first traversal implementation.

```
public void breadthFirst() {
    IntBSTNode p = root;
    Queue queue = new Queue;
    if (p != null) {
        queue.enqueue(p);
        while (!queue.isEmpty()) {
            p = (IntBSTNode) queue.dequeue();
            visit(p);
            if (p.left != null)
                queue.enqueue(p.left);
            if (p.right != null)
                queue.enqueue(p.right);
        }
    }
}
```

## 6.4.2 Depth-First Traversal

*Depth-first traversal* proceeds as far as possible to the left (or right), then backs up until the first crossroad, goes one step to the right (or left), and again as far as possible to the left (or right). We repeat this process until all nodes are visited. This definition, however, does not clearly specify exactly when nodes are visited: before proceeding down the tree or after backing up? There are some variations of the depth-first traversal.

There are three tasks of interest in this type of traversal:

V—Visiting a node

L—Traversing the left subtree

R—Traversing the right subtree

An orderly traversal takes place if these tasks are performed in the same order for each node. The three tasks can themselves be ordered in  $3! = 6$  ways, so there are six possible ordered depth-first traversals:

VLR VRL

LVR RVL

LRV RLV

If the number of different orders still seems like a lot, it can be reduced to three traversals where the move is always from left to right and attention is focused on the first column. The three traversals are given these standard names:

VLR—Preorder tree traversal

LVR—Inorder tree traversal

LRV—Postorder tree traversal

Short and elegant methods can be implemented directly from the symbolic descriptions of these three traversals, as shown in Figure 6.11.

These methods may seem too simplistic, but their real power lies in recursion, in fact, double recursion. The real job is done by the system on the run-time stack. This simplifies coding but lays a heavy burden upon the system. To better understand this process, inorder tree traversal is discussed in some detail.

In inorder traversal, the left subtree of the current node is visited first, then the node itself, and finally, the right subtree. All of this, obviously, holds if the tree is not empty. Before analyzing the run-time stack, the output given by the inorder traversal is determined by referring to Figure 6.12. The following steps correspond to the letters in that figure:

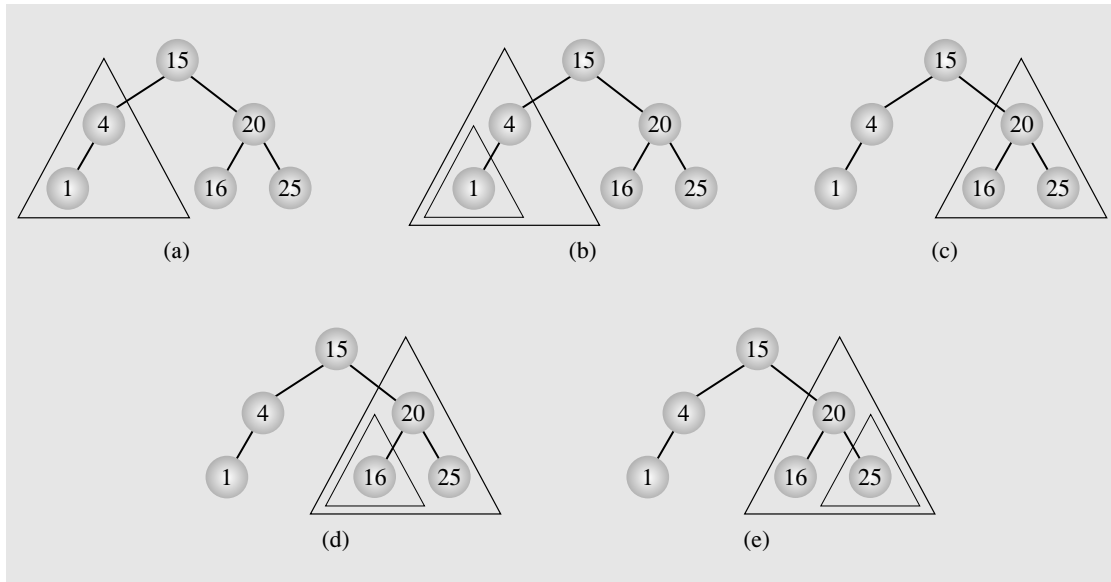
**FIGURE 6.11** Depth-first traversal implementation.

```

protected void preorder(IntBSTNode p) {
    if (p != null) {
        visit(p);
        preorder(p.left);
        preorder(p.right);
    }
}
protected void inorder(IntBSTNode p) {
    if (p != null) {
        inorder(p.left);
        visit(p);
        inorder(p.right);
    }
}
protected void postorder(IntBSTNode p) {
    if (p != null) {
        postorder(p.left);
        postorder(p.right);
        visit(p);
    }
}

```

- (a) Node 15 is the root on which `inorder()` is called for the first time. The method calls itself for node 15's left child, node 4.
- (b) Node 4 is not null, so `inorder()` is called on node 1. Because node 1 is a leaf (that is, both its subtrees are empty), invocations of `inorder()` on the subtrees do not result in other recursive calls of `inorder()`, as the condition in the `if` statement is not met. Thus, after immediate return from `inorder()` called for the empty left subtree, node 1 is visited; afterwards a quick call to `inorder()` is executed for the null right subtree of node 1. After resuming the call for node 4, node 4 is visited. Node 4 has a null right subtree; hence, `inorder()` is called only to check that, and right after resuming the call for node 15, node 15 is visited.
- (c) Node 15 has a right subtree, so `inorder()` is called for node 20.
- (d) `inorder()` is called for node 16, the node is visited, and then on its null left subtree, which is followed by visiting node 16. After a quick call to `inorder()` on the null right subtree of node 16 and return to the call on node 20, node 20 is also visited.

**FIGURE 6.12** Inorder tree traversal.

- (e) `inorder()` is called on node 25, then on its empty left subtree, then node 25 is visited, and finally `inorder()` is called on node 25's empty right subtree.

If the visit includes printing the value stored in a node, then the output is:

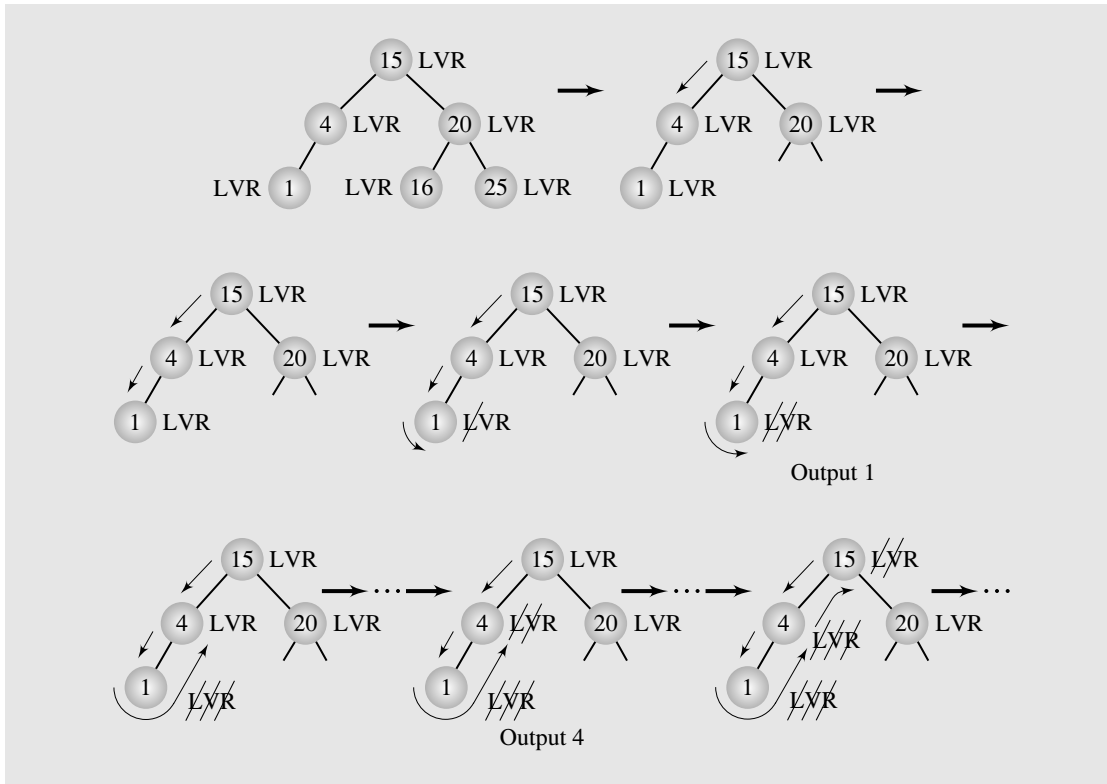
```
1 4 15 16 20 25
```

The key to the traversal is that the three tasks, L, V, and R, are performed for each node separately. This means that the traversal of the right subtree of a node is held pending until the first two tasks, L and V, are accomplished. If the latter two are finished, they can be crossed out as in Figure 6.13.

To present the way `inorder()` works, the behavior of the run-time stack is observed. The numbers in comments in Figure 6.14 indicate return addresses shown on the left-hand side of the code for `inorder()`.

```
void inorder(IntBSTNode node) {
    if (node != null) {
        /* 1 */      inorder(node.left);
        /* 2 */      visit(node);
        /* 3 */      inorder(node.right);
        /* 4 */    }
}
```

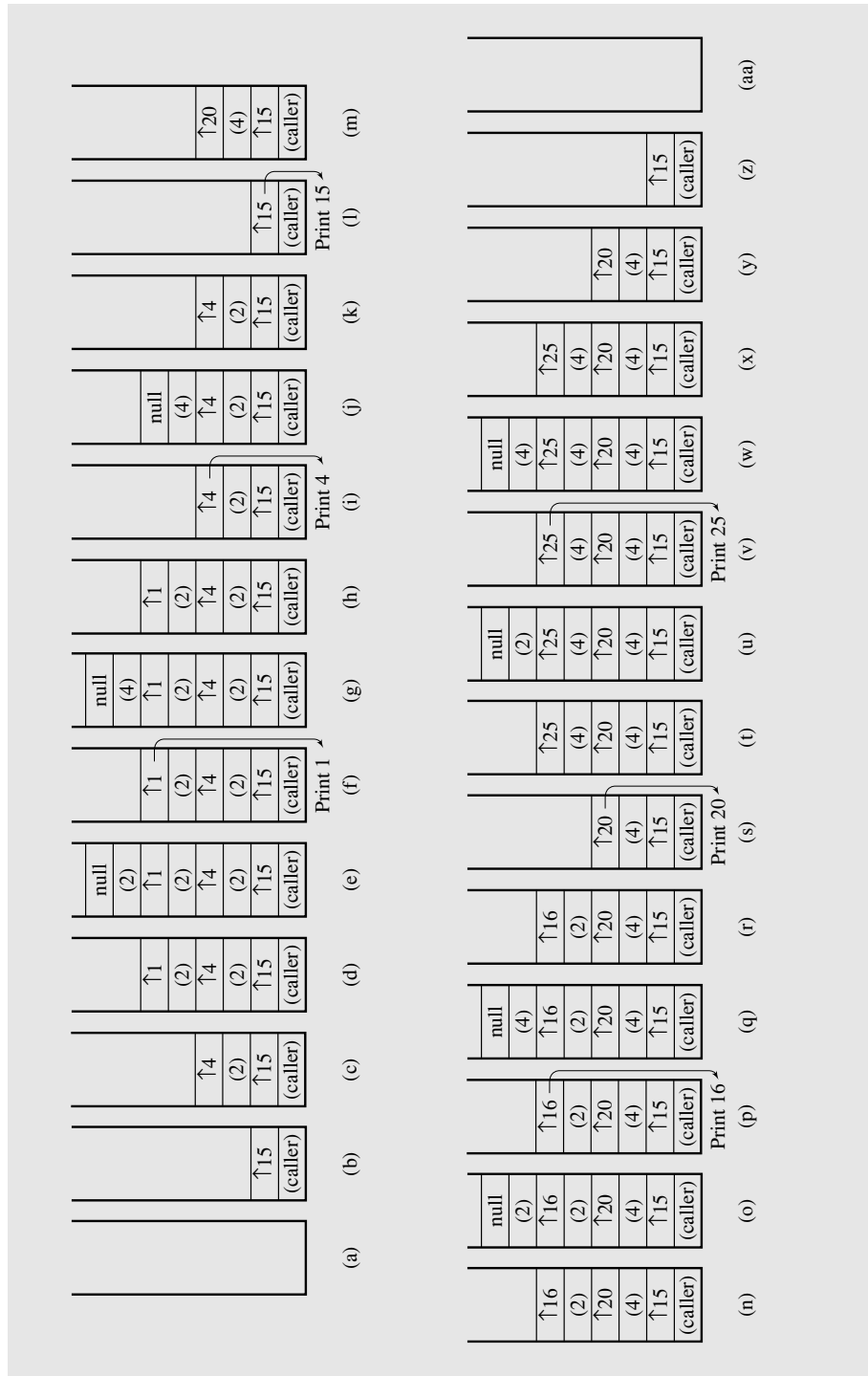
A rectangle with an up arrow and a number indicates the current value of `node` pushed onto the stack. For example,  $\uparrow 4$  means that `node` refers to the node of the tree

**FIGURE 6.13** Details of several of the first steps of inorder traversal.

whose value is the number 4. Figure 6.14 shows the changes of the run-time stack when `inorder()` is executed for the tree in Figure 6.12.

- (a) Initially, the run-time stack is empty (or rather it is assumed that the stack is empty by disregarding what has been stored on it before the first call to `inorder()`).
- (b) Upon the first call, the return address of `inorder()` and the value of `node`,  $\uparrow 15$ , are pushed onto the run-time stack. The tree, referred to by `node`, is not empty, the condition in the `if` statement is satisfied, and `inorder()` is called again with `node 4`.
- (c) Before it is executed, the return address, (2), and current value of `node`,  $\uparrow 4$ , are pushed onto the stack. Because `node` is not null, `inorder()` is about to be invoked for `node`'s left child,  $\uparrow 1$ .
- (d) First, the return address, (2), and the `node`'s value are stored on the stack.
- (e) `inorder()` is called with `node 1`'s left child. The address (2) and the current value of parameter `node`, null, are stored on the stack. Because `node` is null, `inorder()` is exited immediately; upon exit, the activation record is removed from the stack.

**FIGURE 6.14** Changes in the run-time stack during inorder traversal.



- (f) The system goes now to its run-time stack, restores the value of the node,  $\uparrow 1$ , executes the statement under (2), and prints the number 1. Because node is not completely processed, the value of node and address (2) are still on the stack.
- (g) With the right child of node  $\uparrow 1$ , the statement under (3) is executed, which is the next call to `inorder()`. First, however, the address (4) and node's current value, null, are pushed onto the stack. Because node is null, `inorder()` is exited; upon exit, the stack is updated.
- (h) The system now restores the old value of the node,  $\uparrow 1$ , and executes statement (4).
- (i) Because this is `inorder()`'s exit, the system removes the current activation record and refers again to the stack; restores the node's value,  $\uparrow 4$ ; and resumes execution from statement (2). This prints the number 4 and then calls `inorder()` for the right child of node, which is null.

These steps are just the beginning. All of the steps are shown in Figure 6.14.

At this point, consider the problem of a nonrecursive implementation of the three traversal algorithms. As indicated in Chapter 5, a recursive implementation has a tendency to be less efficient than a nonrecursive counterpart. If two recursive calls are used in a method, then the problem of possible inefficiency doubles. Can recursion be eliminated from the implementation? The answer has to be positive because if it is not eliminated in the source code, the system does it for us anyway. So the question should be rephrased: Is it expedient to do so?

Look first at a nonrecursive version of the preorder tree traversal shown in Figure 6.15. The method `iterativePreorder()` is twice as large as `preorder()`, but it is

**FIGURE 6.15** A nonrecursive implementation of preorder tree traversal.

```
public void iterativePreorder() {
    IntBSTNode p = root;
    Stack travStack = new Stack();
    if (p != null) {
        travStack.push(p);
        while (!travStack.isEmpty()) {
            p = (IntBSTNode) travStack.pop();
            visit(p);
            if (p.right != null)
                travStack.push(p.right);
            if (p.left != null) // left child pushed after right
                travStack.push(p.left); // to be on the top of the
                                     // stack;
        }
    }
}
```



still short and legible. However, it uses a stack heavily. Therefore, supporting methods are necessary to process the stack, and the overall implementation is not so short. Although two recursive calls are omitted, there are now up to four calls per iteration of the `while` loop: up to two calls of `push()`, one call of `pop()`, and one call of `visit()`. This can hardly be considered an improvement in efficiency.

In the recursive implementations of the three traversals, note that the only difference is in the order of the lines of code. For example, in `preorder()`, first a node is visited, and then there are calls for the left and right subtrees. On the other hand, in `postorder()`, visiting a node succeeds both calls. Can we so easily transform the nonrecursive version of a left-to-right preorder traversal into a nonrecursive left-to-right postorder traversal? Unfortunately, no. In `iterativePreorder()`, visiting occurs before both children are pushed onto the stack. But this order does not really matter. If the children are pushed first and then the node is visited—that is, if `visit(p)` is placed after both calls to `push()`—the resulting implementation is still a preorder traversal. What matters here is that `visit()` has to follow `pop()`, and the latter has to precede both calls of `push()`. Therefore, nonrecursive implementations of inorder and postorder traversals have to be developed independently.

A nonrecursive version of postorder traversal can be obtained rather easily if we observe that the sequence generated by a left-to-right postorder traversal (an LRV order) is the same as the reversed sequence generated by a right-to-left preorder traversal (a VRL order). In this case, the implementation of `iterativePreorder()` can be adopted to create `iterativePostorder()`. This means that two stacks have to be used, one to visit each node in the reverse order after a right-to-left preorder traversal is finished. It is, however, possible to develop a function for postorder traversal that pushes onto the stack a node that has two descendants, once before traversing its left subtree and once before traversing its right subtree. An auxiliary reference `q` is used to distinguish between these two cases. Nodes with one descendant are pushed only once, and leaves do not need to be pushed at all (Figure 6.16).

A nonrecursive inorder tree traversal is also a complicated matter. One possible implementation is given in Figure 6.17. In this case, we can clearly see the power of recursion: `iterativeInorder()` is almost unreadable, and without thorough explanation, it is not easy to determine the purpose of this method. On the other hand, recursive `inorder()` immediately demonstrates a purpose and logic. Therefore, `iterativeInorder()` can be defended in one case only: if it is shown that there is a substantial gain in execution time and that the method is called often in a program. Otherwise, `inorder()` is preferable to its iterative counterpart.

### 6.4.3 Stackless Depth-First Traversal

#### *Threaded Trees*

The traversal methods analyzed in the preceding section were either recursive or nonrecursive, but both kinds used a stack either implicitly or explicitly to store information about nodes whose processing has not been finished. In the case of recursive methods, the run-time stack was utilized. In the case of nonrecursive variants, an explicitly

**FIGURE 6.16** A nonrecursive implementation of postorder tree traversal.

```

public void iterativePostorder() {
    BSTNode p = root, q = root;
    Stack travStack = new Stack();
    while (p != null) {
        for ( ; p.left != null; p = p.left)
            travStack.push(p);
        while (p != null && (p.right == null || p.right == q)) {
            visit(p);
            q = p;
            if (travStack.isEmpty())
                return;
            p = (BSTNode) travStack.pop();
        }
        travStack.push(p);
        p = p.right;
    }
}

```

**FIGURE 6.17** A nonrecursive implementation of inorder tree traversal.

```

public void iterativeInorder() {
    IntBSTNode p = root;
    Stack travStack = new Stack();
    while (p != null) {
        while(p != null) {
            // stack the right child (if any)
            if (p.right != null) // and the node itself when going
                travStack.push(p.right); // to the left;
            travStack.push(p);
            p = p.left;
        }
        p = (IntBSTNode) travStack.pop(); // pop a node with no left child
        while (!travStack.isEmpty() && p.right == null) { // visit it and all
            visit(p); // nodes with no right child;
            p = (IntBSTNode) travStack.pop();
        }
        visit(p); // visit also the first node with
        if (!travStack.isEmpty()) // a right child (if any);
            p = (IntBSTNode) travStack.pop();
        else p = null;
    }
}

```

defined and user-maintained stack was used. The concern is that some additional time has to be spent to maintain the stack, and some more space has to be set aside for the stack itself. In the worst case, when the tree is unfavorably skewed, the stack may hold information about almost every node of the tree, a serious concern for very large trees.

It is more efficient to incorporate the stack as part of the tree. This is done by incorporating *threads* in a given node. Threads are references to the predecessor and successor of the node according to an inorder traversal, and trees whose nodes use threads are called *threaded trees*. Four reference fields are needed for each node in the tree, which again takes up valuable space.

The problem can be solved by overloading existing reference fields. In trees, left or right references are references to children, but they can also be used as references to predecessors and successors, thereby being overloaded with meaning. To distinguish these meanings, a new data member has to be used to indicate the current meaning of the references.

Because a reference can refer to one node at a time, the left reference is either a reference to the left child or to the predecessor. Analogously, the right reference refers either to the right subtree or to the successor (Figure 6.18a).

**FIGURE 6.18** (a) A threaded tree and (b) an inorder traversal's path in a threaded tree with right successors only.

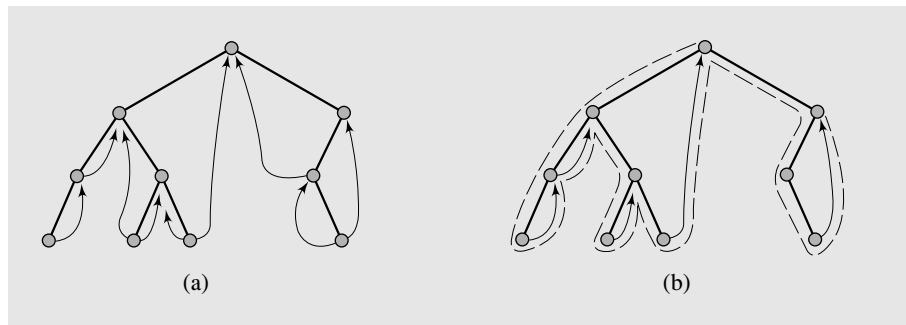


Figure 6.18a suggests that references to both predecessors and successors have to be maintained, which is not always the case. It may be sufficient to use only one thread, as shown in the implementation of the inorder traversal of a threaded tree, which requires only references to successors (Figure 6.18b).

The method is relatively simple. The dashed line in Figure 6.18b indicates the order in which *p* accesses nodes in the tree. Note that only one variable, *p*, is needed to traverse the tree. No stack is needed; therefore, space is saved. But is it really? As indicated, nodes require a field indicating how the right reference is being used. In the implementation of `threadedInorder()`, the Boolean field `successor` plays this role as shown in Figure 6.19. Hence, `successor` requires only one bit of computer memory, insignificant in comparison to other fields. However, the Java Virtual Machine does not use type Boolean, and Boolean variables are fields and represented as integers, which is 4 bytes (Boolean arrays are a slightly different matter). If so, the

**FIGURE 6.19** Implementation of the threaded tree and the inorder traversal of a threaded tree.

```

/***** IntThreadedTreeNode.java *****/
*
*      binary search threaded tree of integers
*/

class IntThreadedTreeNode {
    protected int key;
    protected boolean sucessor;
    protected IntThreadedTreeNode left, right;
    public IntThreadedTreeNode() {
        left = right = null; sucessor = false;
    }
    public IntThreadedTreeNode(int el) {
        this(el,null,null);
    }
    public IntThreadedTreeNode(int el, IntThreadedTreeNode lt,
                               IntThreadedTreeNode rt) {
        key = el; left = lt; right = rt; sucessor = false;
    }
}

/***** IntThreadedTree.java *****/
*
*      binary search threaded tree of integers
*/

public class IntThreadedTree {
    private IntThreadedNode root;
    public IntThreadedTree() {
        root = null;
    }
    protected void visit(intThreadedTreeNode p) {
        System.out.print(p.key + " ");
    }
    protected void threadedInorder() {
        IntThreadedNode prev, p = root;
        if (p != null) {
            while (p.left != null) // process only nonempty trees;
                // go to the leftmost node;
                p = p.left;
            while (p != null) {
                visit(p);
                prev = p;
            }
        }
    }
}

```

**FIGURE 6.19** (continued)

```

        p = p.right;           // go to the right node and only
        if (p != null && !prev.successor)// if it is a descendant
            while (p.left != null)// go to the leftmost node,
                p = p.left;     // otherwise visit the
                                // successor;
    }
}
}
public void threadedInsert(int el) {
    // Figure 6.24
}
}
}

```

successor field needs at least 4 bytes, which defeats the argument about saving space by using threaded trees.

Threaded trees can also be used for preorder and postorder traversals. In preorder traversal, the current node is visited first and then traversal continues with its left descendant, if any, or right descendant, if any. If the current node is a leaf, threads are used to go through the chain of its already visited inorder successors to restart traversal with the right descendant of the last successor.

Postorder traversal is only slightly more complicated. First, a dummy node is created that has the root as its left descendant. In the traversal process, a variable can be used to check the type of the current action. If the action is left traversal and the current node has a left descendant, then the descendant is traversed; otherwise, the action is changed to right traversal. If the action is right traversal and the current node has a right nonthread descendant, then the descendant is traversed and the action is changed to left traversal; otherwise, the action changes to visiting a node. If the action is visiting a node, then the current node is visited, and afterward, its postorder successor has to be found. If the current node's parent is accessible through a thread (that is, current node is parent's left child), then traversal is set to continue with the right descendant of the parent. If the current node has no right descendant, then it is the end of the right-extended chain of nodes. First, the beginning of the chain is reached through the thread of the current node, then the right references of nodes in the chain are reversed, and finally, the chain is scanned backward, each node is visited, and then right references are restored to their previous setting.

### *Traversal through Tree Transformation*

The first set of traversal algorithms analyzed earlier in this chapter needed a stack to retain some information necessary for successful processing. Threaded trees incorporated a stack as part of the tree at the cost of extending the nodes by one field to

make a distinction between the interpretation of the right reference as a reference to the child or to the successor. Two such tag fields are needed if both successor and predecessor are considered. However, it is possible to traverse a tree without using any stack or threads. There are many such algorithms, all of them made possible by making temporary changes in the tree during traversal. These changes consist of re-assigning new values to some reference fields. However, the tree may temporarily lose its tree structure, which needs to be restored before traversal is finished. The technique is illustrated by an elegant algorithm devised by Joseph M. Morris applied to inorder traversal.

First, it is easy to notice that inorder traversal is very simple for degenerate trees, in which no node has a left child (see Figure 6.1e). No left subtree has to be considered for any node. Therefore, the usual three steps, LVR (visit left subtree, visit node, visit right subtree), for each node in inorder traversal turn into two steps, VR. No information needs to be retained about the current status of the node being processed before traversing its left child, simply because there is no left child. Morris's algorithm takes into account this observation by temporarily transforming the tree so that the node being processed has no left child; hence, this node can be visited and its right subtree processed. The algorithm can be summarized as follows:

```
MorrisInorder()
  while not finished
    if node has no left descendant
      visit it;
      go to the right;
    else make this node the right child of the rightmost node in its left descendant;
      go to this left descendant;
```

This algorithm successfully traverses the tree, but only once, because it destroys its original structure. Therefore, some information has to be retained to allow the tree to restore its original form. This is achieved by retaining the left reference of the node moved down its right subtree, as in the case of nodes 10 and 5 in Figure 6.21.

An implementation of the algorithm is shown in Figure 6.20, and the details of the execution are illustrated in Figure 6.21. The following description is divided into actions performed in consecutive iterations of the outer `while` loop:

1. Initially, `p` refers to the root, which has a left child. As a result, the inner `while` loop takes `tmp` to node 7, which is the rightmost node of the left child of node 10, referred by `p` (Figure 6.21a). Because no transformation has been done, `tmp` has no right child, and in the inner `if` statement, the root, node 10, is made the right child of `tmp`. Node 10 retains its left reference to node 5, its original left child. Now, the tree is not a tree anymore, because it contains a cycle (Figure 6.21b). This completes the first iteration.
2. Reference `p` refers to node 5, which also has a left child. First, `tmp` reaches the largest node in this subtree, which is 3 (Figure 6.21c), and then the current root, node 5,

**FIGURE 6.20** Implementation of the Morris algorithm for inorder traversal.

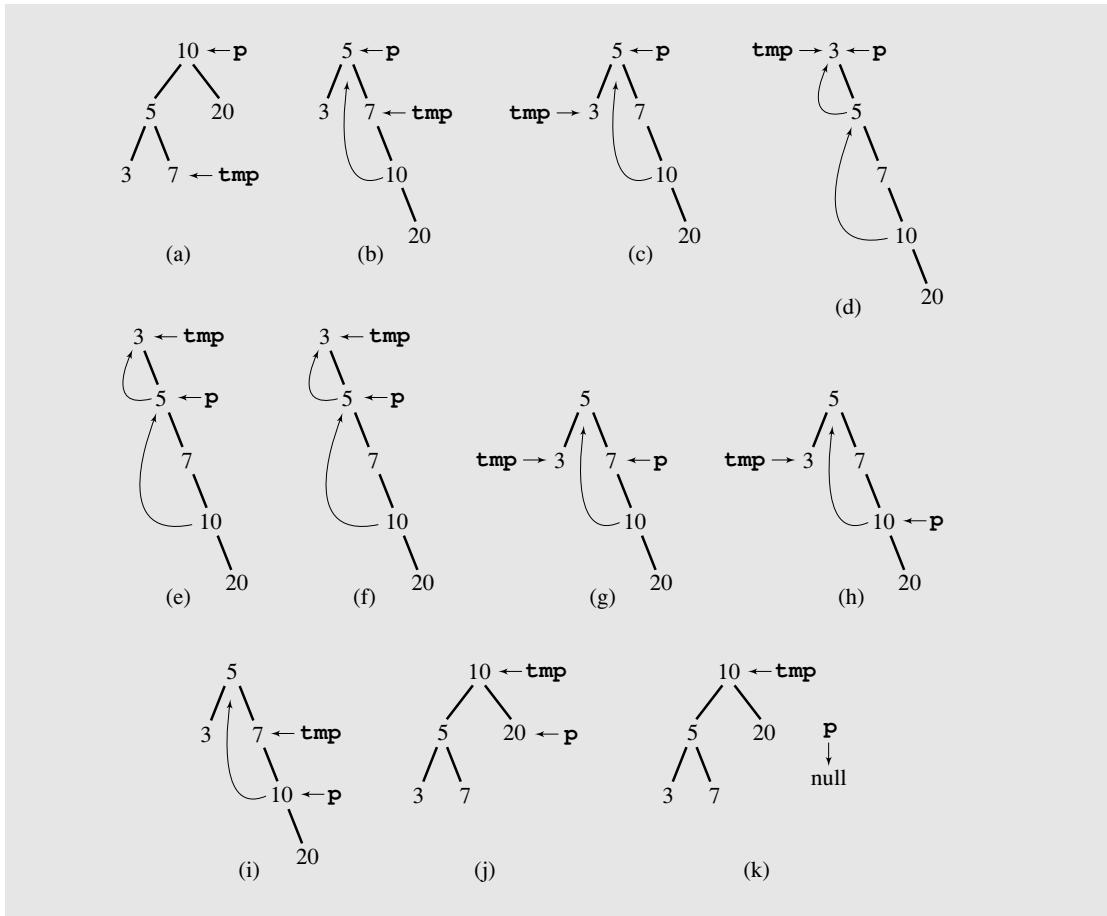
```

public void MorrisInorder() {
    IntBSTNode p = root, tmp;
    while (p != null)
        if (p.left == null) {
            visit(p);
            p = p.right;
        }
        else {
            tmp = p.left;
            while (tmp.right != null && // go to the rightmost node of
                tmp.right != p) // the left subtree or
                tmp = tmp.right; // to the temporary parent of p;
            if (tmp.right == null) { // if 'true' rightmost node was
                tmp.right = p; // reached, make it a temporary
                p = p.left; // parent of the current root,
            }
            else { // else a temporary parent has been
                visit(p); // found; visit node p and then cut
                tmp.right = null; // the right pointer of the current
                p = p.right; // parent, whereby it ceases to be
            } // a parent;
        }
    }
}

```

becomes the right child of node 3 while retaining contact with node 3 through its left reference (Figure 6.21d).

3. Because node 3, referred by *p*, has no left child, in the third iteration, this node is visited, and *p* is reassigned to its right child, node 5 (Figure 6.21e).
4. Node 5 has a nonnull left reference, so *tmp* finds a temporary parent of node 5, which is the same node currently referred to by *tmp* (Figure 6.21f). Next, node 5 is visited, and configuration of the tree in Figure 6.21b is reestablished by setting the right reference of node 3 to null (Figure 6.21g).
5. Node 7, referred to now by *p*, is visited, and *p* moves down to its right child (6.21h).
6. *tmp* is updated to refer to the temporary parent of node 10 (Figure 6.21i). Next, node 10 is visited and then reestablished to its status of root by nullifying the right reference of node 7 (Figure 6.21j).

**FIGURE 6.21** Tree traversal with the Morris method.

7. Finally, node 20 is visited without further ado, because it has no left child, nor has its position been altered.

This completes the execution of Morris's algorithm. Notice that there are seven iterations of the outer `while` loop for only five nodes in the tree in Figure 6.21. This is due to the fact that there are two left children in the tree, so the number of extra iterations depends on the number of left children in the entire tree. The algorithm performs worse for trees with a large number of such children.

Preorder traversal is easily obtainable from inorder traversal by moving `visit()` from the inner `else` clause to the inner `if` clause. In this way, a node is visited before a tree transformation.

Postorder traversal can also be obtained from inorder traversal by first creating a dummy node whose left descendant is the tree being processed and whose right descen-



dant is null. Then this temporarily extended tree is the subject of traversal as in inorder traversal except that in the inner `else` clause, after finding a temporary parent, nodes between `p.left` (included) and `p` (excluded) extended to the right in a modified tree are processed in the reverse order. To process them in constant time, the chain of nodes is scanned down and right references are reversed to refer to parents of nodes. Then the same chain is scanned upward, each node is visited, and the right references are restored to their original setting.

How efficient are the traversal procedures discussed in this section? All of them run in  $\Theta(n)$  time, threaded implementation requires  $\Theta(n)$  more space for threads than nonthreaded binary search trees, and both recursive and iterative traversals require  $O(n)$  additional space (on the run-time stack or user-defined stack). Several dozen runs on randomly generated trees of 5,000 nodes indicate that for preorder and inorder traversal routines (recursive, iterative, Morris, and threaded), the difference in the execution time is only on the order of 5–10%. Morris traversals have one undeniable advantage over other types of traversals: They do not require additional space. Recursive traversals rely on the run-time stack, which can be overflowed when traversing trees of large height. Iterative traversals also use a stack, and although the stack can be overflowed as well, the problem is not as imminent as in the case of the run-time stack. Threaded trees use nodes that are larger than the nodes used by nonthreaded trees, which usually should not pose a problem. But both iterative and threaded implementations are much less intuitive than their recursive counterparts; therefore, the clarity of implementation and comparable run time clearly favors, in most situations, recursive implementations over other implementations.

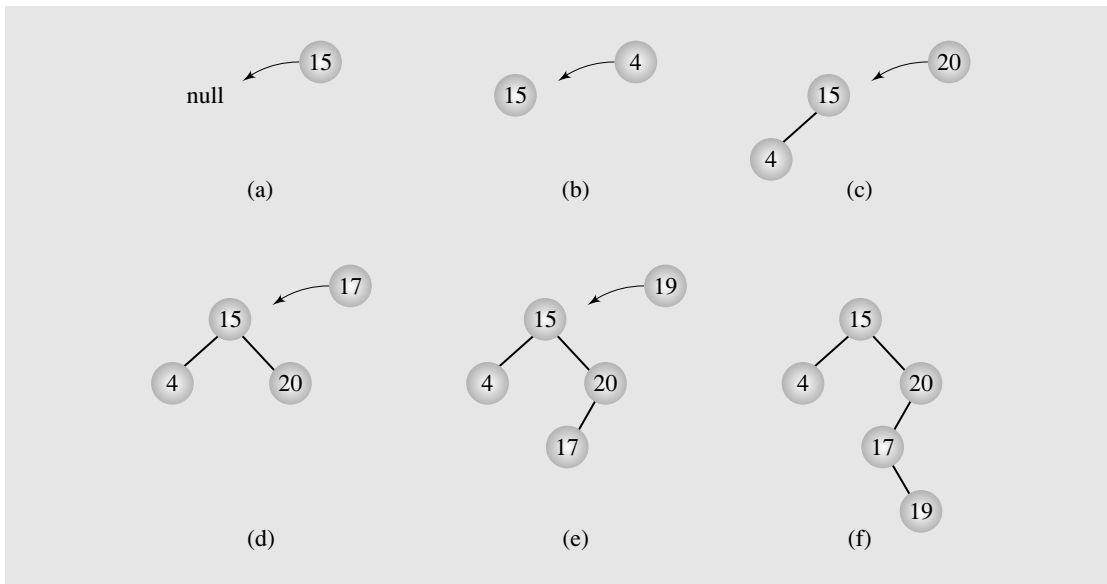
## 6.5

## INSERTION

Searching a binary tree does not modify the tree. It scans the tree in a predetermined way to access some or all of the keys in the tree, but the tree itself remains undisturbed after such an operation. Tree traversals can change the tree but they may also leave it in the same condition. Whether or not the tree is modified depends on the actions prescribed by `visit()`. There are certain operations that always make some systematic changes in the tree, such as adding nodes, deleting them, modifying elements, merging trees, and balancing trees to reduce their height. This section deals only with inserting a node into a binary search tree.

To insert a new node with key `e1`, a tree node with a dead end has to be reached, and the new node has to be attached to it. Such a tree node is found using the same technique that tree searching used: The key `e1` is compared to the key of a node currently being examined during a tree scan. If `e1` is less than that key, the left child (if any) of `p` is tried; otherwise, the right child (if any) is tested. If the child of `p` to be tested is empty, the scanning is discontinued and the new node becomes this child. The procedure is illustrated in Figure 6.22. Figure 6.23 contains an implementation of the algorithm to insert a node.

In analyzing the problem of traversing binary trees, three approaches have been presented: traversing with the help of a stack, traversing with the aid of threads, and traversing through tree transformation. The first approach does not change the tree

**FIGURE 6.22** Inserting nodes into binary search trees.**FIGURE 6.23** Implementation of the insertion algorithm.

```

public void insert(int el) {
    IntBSTNode p = root, prev = null;
    while (p != null) { // find a place for inserting new node;
        prev = p;
        if (p.key < el)
            p = p.right;
        else p = p.left;
    }
    if (root == null) // tree is empty;
        root = new IntBSTNode(el);
    else if (prev.key < el)
        prev.right = new IntBSTNode(el);
    else prev.left = new IntBSTNode(el);
}

```

during the process. The third approach changes it, but restores it to the same condition as before it started. Only the second approach needs some preparatory operations on the tree to become feasible: It requires threads. These threads may be created each time before the traversal procedure starts its task and removed each time it is finished. If the traversal is performed infrequently, this becomes a viable option. Another

approach is to maintain the threads in all operations on the tree when inserting a new element in the binary search tree.

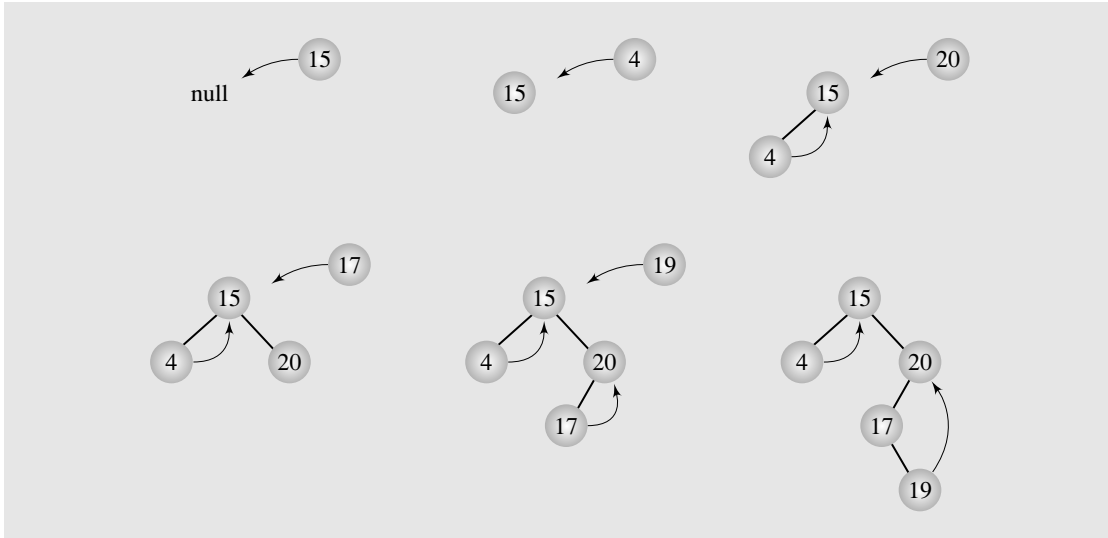
The method for inserting a node in a threaded tree is a simple extension of `insert()` for regular binary search trees to adjust threads whenever applicable. This method is for inorder tree traversal and it only takes care of successors, not predecessors.

A node with a right child has a successor some place in its right subtree. Therefore, it does not need a successor thread. Such threads are needed to allow climbing the tree, not going down it. A node with no right child has its successor somewhere above it. Except for one node, all nodes with no right children will have threads to their successors. If a node becomes the right child of another node, it inherits the successor from its new parent. If a node becomes a left child of another node, this parent becomes its successor. Figure 6.24 contains the implementation of this algorithm, `threadedInsert()`. The first few insertions are shown in Figure 6.25.

**FIGURE 6.24** Implementation of the algorithm to insert nodes into a threaded tree.

```
public void threadedInsert(int e1) {
    IntThreadedNode newNode = new IntThreadedNode(e1);
    if (root == null) {           // tree is empty
        root = newNode;
        return;
    }
    IntThreadedNode p = root, prev = null;
    while (p != null) {           // find a place to insert newNode;
        prev = p;
        if (e1 < p.key)
            p = p.left;
        else if (!p.hasSuccessor) // go to the right only if it is
            p = p.right;         // a descendant, not a successor;
        else break;              // don't follow successor link;
    }
    if (e1 < prev.key) {         // if newNode is left child of
        prev.left = newNode;     // its parent, the parent
        newNode.hasSuccessor = true; // also becomes its successor;
        newNode.right = prev;
    }
    else if (prev.hasSuccessor) { // if parent of the newNode
        newNode.hasSuccessor = true; // is not the rightmost node,
        prev.hasSuccessor = false; // make parent's successor
        newNode.right = prev.right; // newNode's successor,
        prev.right = newNode;
    }
    else prev.right = newNode;   // otherwise it has no successor;
}
}
```

**FIGURE 6.25** Inserting nodes into a threaded tree.

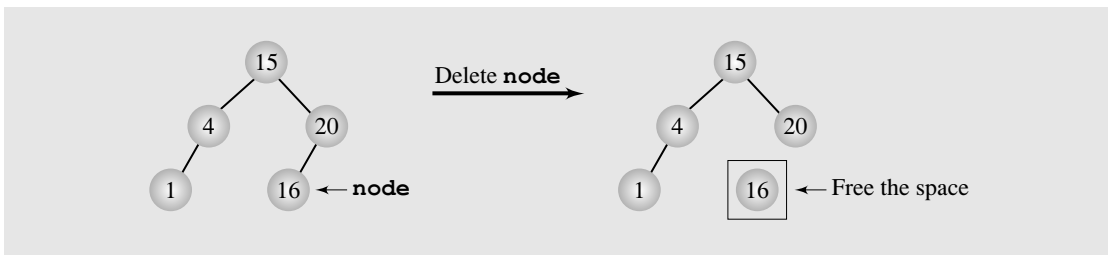


## 6.6 DELETION

Deleting a node is another operation necessary to maintain a binary search tree. The level of complexity in performing the operation depends on the position of the node to be deleted in the tree. It is by far more difficult to delete a node having two subtrees than to delete a leaf; the complexity of the deletion algorithm is proportional to the number of children the node has. There are three cases of deleting a node from the binary search tree:

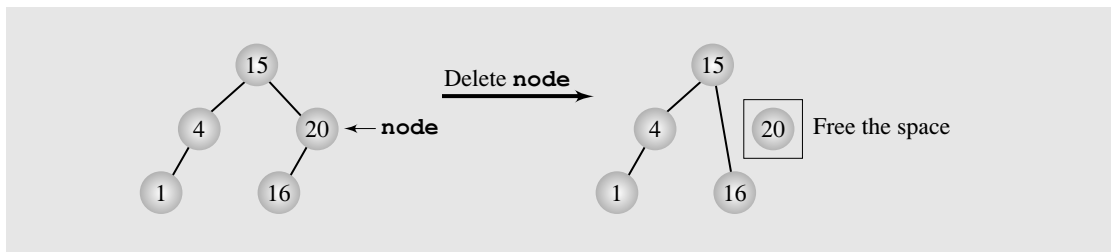
1. The node is a leaf; it has no children. This is the easiest case to deal with. The appropriate reference of its parent is set to null and the space occupied by the deleted node is later claimed by the garbage collector as in Figure 6.26.

**FIGURE 6.26** Deleting a leaf.



2. The node has one child. This case is not complicated. The parent's reference to the node is reset to refer to the node's child. In this way, the node's children are lifted up by one level and all great-great-. . . grandchildren lose one "great" from their kinship designations. For example, the node containing 20 (see Figure 6.27) is deleted by setting the right reference of its parent containing 15 to refer to 20's only child, which is 16.

**FIGURE 6.27** Deleting a node with one child.

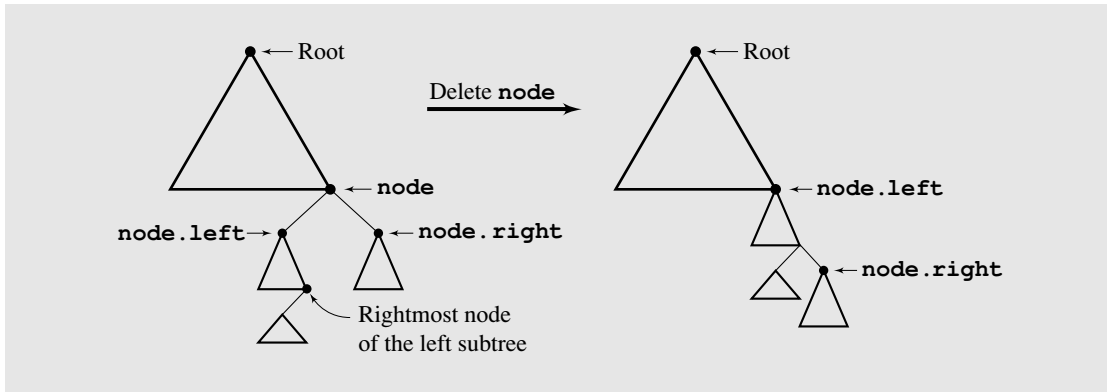


3. The node has two children. In this case, no one-step operation can be performed because the parent's right or left reference cannot refer to both the node's children at the same time. This section discusses two different solutions to this problem.

### 6.6.1 Deletion by Merging

This solution makes one tree out of the two subtrees of the node and then attaches it to the node's parent. This technique is called *deleting by merging*. But how can we merge these subtrees? By the nature of binary search trees, every key of the right subtree is greater than every key of the left subtree, so the best thing to do is to find in the left subtree the node with the greatest key and make it a parent of the right subtree. Symmetrically, the node with the lowest key can be found in the right subtree and made a parent of the left subtree.

The desired node is the rightmost node of the left subtree. It can be located by moving along this subtree and taking right references until null is encountered. This means that this node will not have a right child, and there is no danger of violating the property of binary search trees in the original tree by setting that rightmost node's right reference to the right subtree. (The same could be done by setting the left reference of the leftmost node of the right subtree to the left subtree.) Figure 6.28 depicts this operation. Figure 6.29 contains the implementation of the algorithm.

**FIGURE 6.28** Summary of deleting by merging.**FIGURE 6.29** Implementation of algorithm for deleting by merging.

```

public void deleteByMerging(int el) {
    IntBSTNode tmp, node, p = root, prev = null;
    while (p != null && p.key != el) { // find the node p
        prev = p; // with element el;
        if (p.key < el)
            p = p.right;
        else p = p.left;
    }
    node = p;
    if (p != null && p.key == el) {
        if (node.right == null) // node has no right child: its left
            node = node.left; // child (if any) is attached to its
                               // parent;
        else if (node.left == null) // node has no left child: its right
            node = node.right; // child is attached to its parent;
        else { // be ready for merging subtrees;
            tmp = node.left; // 1. move left
            while (tmp.right != null) // 2. and then right as far as
                tmp = tmp.right; // possible;
            tmp.right = // 3. establish the link between
                node.right; // the rightmost node of the left
                               // subtree and the right subtree;
            node = node.left; // 4.
        }
    }
}

```

**FIGURE 6.29** (continued)

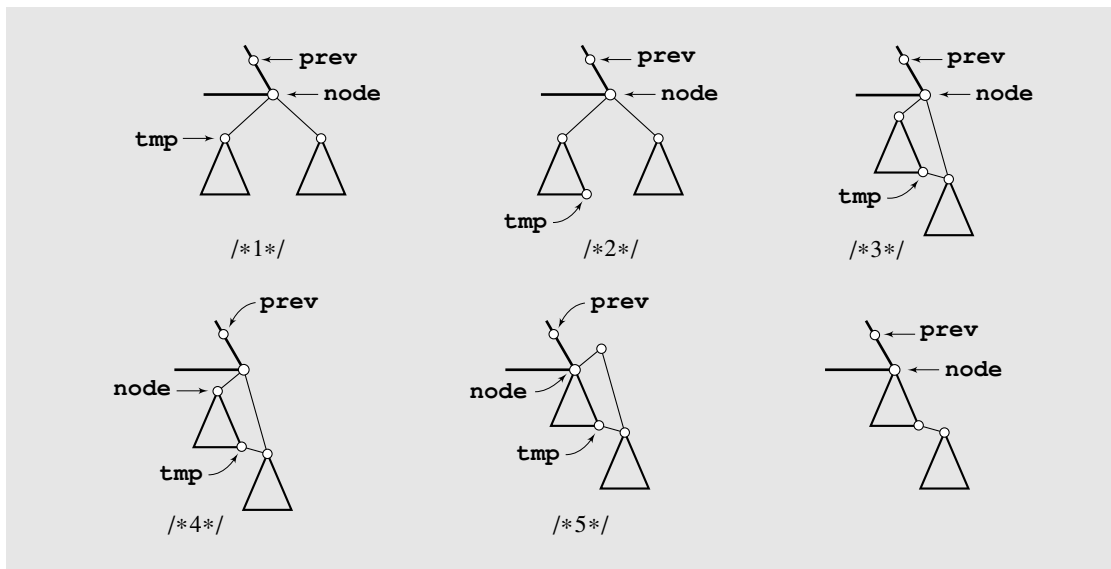
```

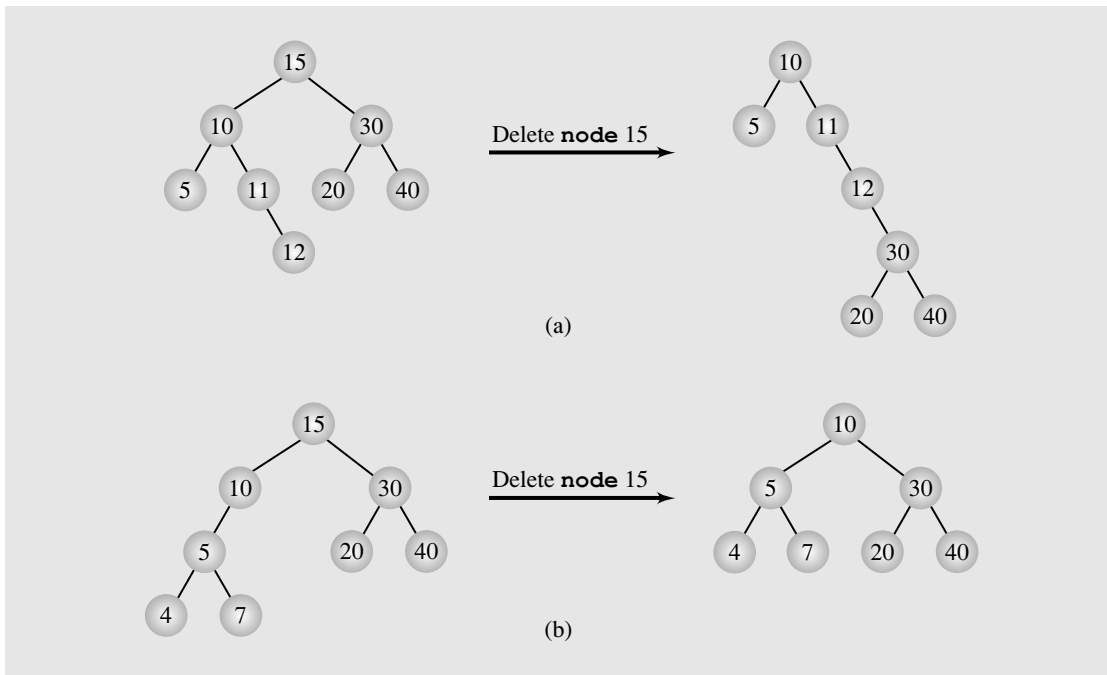
    }
    if (p == root)
        root = node;
    else if (prev.left == p)
        prev.left = node;
    else prev.right = node; // 5.
}
else if (root != null)
    System.out.println("key " + e1 + " is not in the tree");
else System.out.println("the tree is empty");
}

```

Figure 6.30 shows each step of this operation. It shows what changes are made when `deleteByMerging()` is executed. The numbers in this figure correspond to numbers put in comments in the code in Figure 6.29.

The algorithm for deletion by merging may result in increasing the height of the tree. In some cases, the new tree may be highly unbalanced, as Figure 6.31a illustrates.

**FIGURE 6.30** Details of deleting by merging.

**FIGURE 6.31** The height of a tree can be (a) extended or (b) reduced after deleting by merging.

Sometimes the height may be reduced (see Figure 6.31b). This algorithm is not necessarily inefficient, but it is certainly far from perfect. There is a need for an algorithm that does not give the tree the chance to increase its height when deleting one of its nodes.

### 6.6.2 Deletion by Copying

Another solution, called *deletion by copying*, was proposed by Thomas Hibbard and Donald Knuth. If the node has two children, the problem can be reduced to one of two simple cases: The node is a leaf or the node has only one nonempty child. This can be done by replacing the key being deleted with its immediate predecessor (or successor). As already indicated in the discussion of deletion by merging, a key's predecessor is the key in the rightmost node in the left subtree (and analogically, its immediate successor is the key in the leftmost node in the right subtree). First, the predecessor has to be located. This is done, again, by moving one step to the left by first reaching the root of the node's left subtree and then moving as far to the right as possible. Next, the key of the located node replaces the key to be deleted. And that is where one of two simple cases comes into play. If the rightmost node is a leaf, the first case applies; however, if it has one child, the second case is relevant. In this way, deletion by copying removes a key  $k_1$  by overwriting it by another key  $k_2$  and then removing the node that holds  $k_2$ , whereas deletion by merging consisted of removing a key  $k_1$  along with the node that holds it.



An implementation of this algorithm is in Figure 6.32. A step-by-step trace is shown in Figure 6.33, and the numbers under the diagrams refer to the numbers indicated in comments included in the implementation of `deleteByCopying()`.

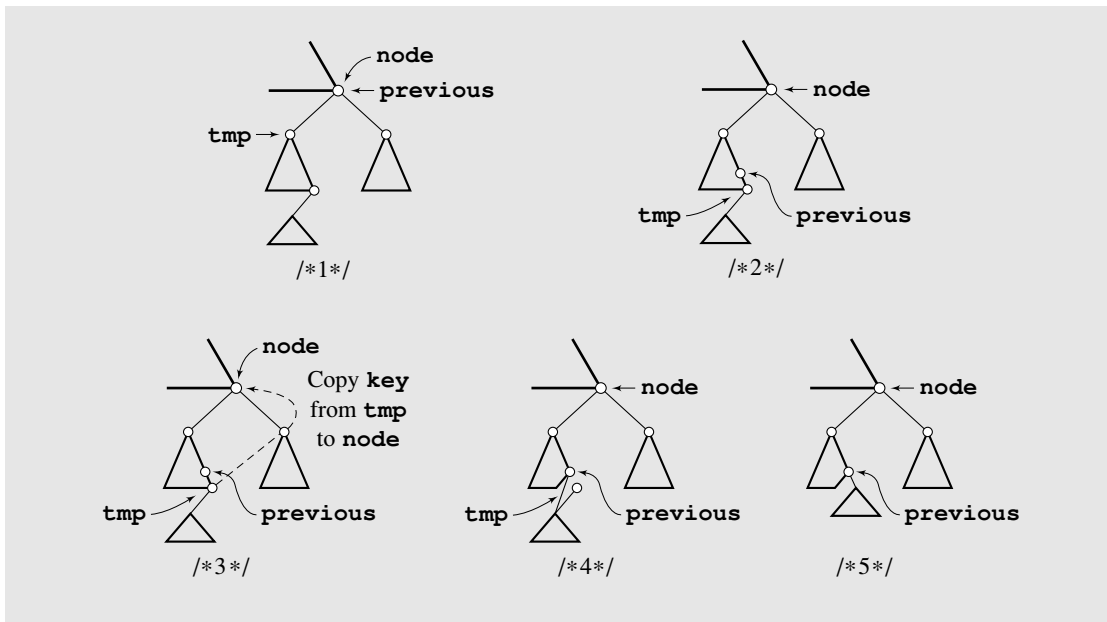
This algorithm does not increase the height of the tree, but it still causes a problem if it is applied many times along with insertion. The algorithm is asymmetric; it

**FIGURE 6.32** Implementation of an algorithm for deleting by copying.

```

public void deleteByCopying(int el) {
    IntBSTNode node, p = root, prev = null;
    while (p != null && p.key != el)      { // find the node p
        prev = p;                          // with element el;
        if (p.key < el)
            p = p.right;
        else p = p.left;
    }
    node = p;
    if (p != null && p == el) {
        if (node.right == null)            // node has no right child;
            node = node.left;
        else if (node.left == null)       // no left child for node;
            node = node.right;
        else {
            IntBSTNode tmp = node.left;    // node has both children;
            IntBSTNode previous = node;    // 1.
            while (tmp.right != null) {    // 2. find the rightmost
                previous = tmp;           // position in the
                tmp = tmp.right;          // left subtree of node;
            }
            node.key = tmp.key;            // 3. overwrite the reference
                                           // of the key being deleted;
            if (previous == node)         // if node's left child's
                previous.left = tmp.left; // right subtree is null;
            else previous.right = tmp.left; // 4.
        }
    }
    if (p == root)
        root = node;
    else if (prev.left == p)
        prev.left = node;
    else prev.right = node;
}
else if (root != null)
    System.out.println("key " + el + " is not in the tree");
else System.out.println("the tree is empty");
}

```

**FIGURE 6.33** Deleting by copying.

always deletes the node of the immediate predecessor of the key in *node*, possibly reducing the height of the left subtree and leaving the right subtree unaffected. Therefore, the right subtree of *node* can grow after later insertions, and if the key in *node* is again deleted, the height of the right tree remains the same. After many insertions and deletions, the entire tree becomes right unbalanced, with the right tree bushier and larger than the left subtree.

To circumvent this problem, a simple improvement can make the algorithm symmetrical. The algorithm can alternately delete the predecessor of the key in *node* from the left subtree and delete its successor from the right subtree. The improvement is significant. Simulations performed by Jeffrey Eppinger show that an expected internal path length (IPL) for many insertions and asymmetric deletions is  $\Theta(n \lg^3 n)$  for  $n$  nodes, and when symmetric deletions are used, the expected IPL becomes  $\Theta(n \lg n)$ . Theoretical results obtained by J. Culberson confirm these conclusions. According to Culberson, insertions and asymmetric deletions give  $\Theta(n\sqrt{n})$  for the expected IPL and  $\Theta(\sqrt{n})$  for the average search time (average path length), whereas symmetric deletions lead to  $\Theta(\lg n)$  for the average search time, and as before,  $\Theta(n \lg n)$  for the average IPL.

These results may be of moderate importance for practical applications. Experiments show that for a 2,048-node binary tree, only after 1.5 million insertions and asymmetric deletions does the IPL become worse than in a randomly generated tree.

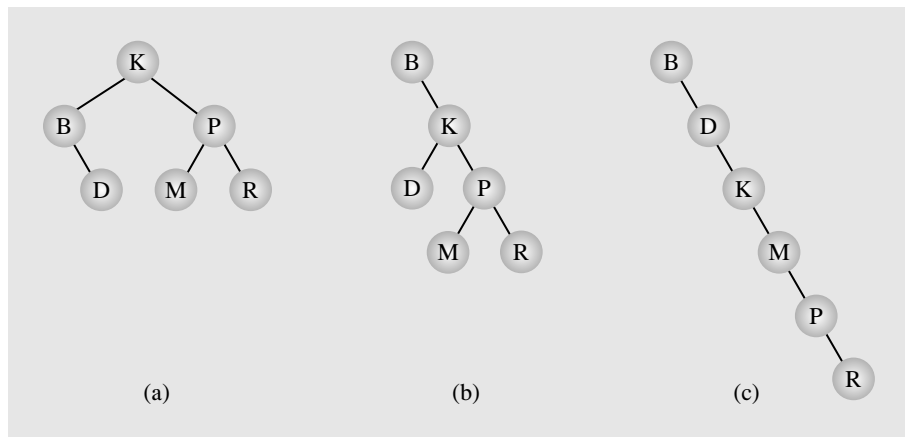
Theoretical results are only fragmentary because of the extraordinary complexity of the problem. Arne Jonassen and Donald Knuth analyzed the problem of random

insertions and deletions for a tree of only three nodes, which required using Bessel functions and bivariate integral equations, and the analysis turned out to rank among “the more difficult of all exact analyses of algorithms that have been carried out to date.” Therefore, the reliance on experimental results is not surprising.

## 6.7 BALANCING A TREE

At the beginning of this chapter, two arguments were presented in favor of trees: They are well suited to represent the hierarchical structure of a certain domain, and the search process is much faster using trees instead of linked lists. The second argument, however, does not always hold. It all depends on what the tree looks like. Figure 6.34 shows three binary search trees. All of them store the same data, but obviously, the tree in Figure 6.34a is the best and Figure 6.34c is the worst. In the worst case, three tests are needed in the former and six tests are needed in the latter to locate an object. The problem with the trees in Figures 6.34b and 6.34c is that they are somewhat unsymmetrical, or lopsided; that is, objects in the tree are not distributed evenly to the extent that the tree in Figure 6.34c practically turned into a linked list, although, formally, it is still a tree. Such a situation does not arise in balanced trees.

**FIGURE 6.34** Different binary search trees with the same information.



A binary tree is *height-balanced* or simply *balanced* if the difference in height of both subtrees of any node in the tree is either zero or one. For example, for node *K* in Figure 6.34b, the difference between the heights of its subtrees being equal to one is acceptable. But for node *B* this difference is three, which means that the entire tree is unbalanced. For the same node *B* in 6.34c, the difference is the worst possible, namely, five. Also, a tree is considered *perfectly balanced* if it is balanced and all leaves are to be found on one level or two levels.

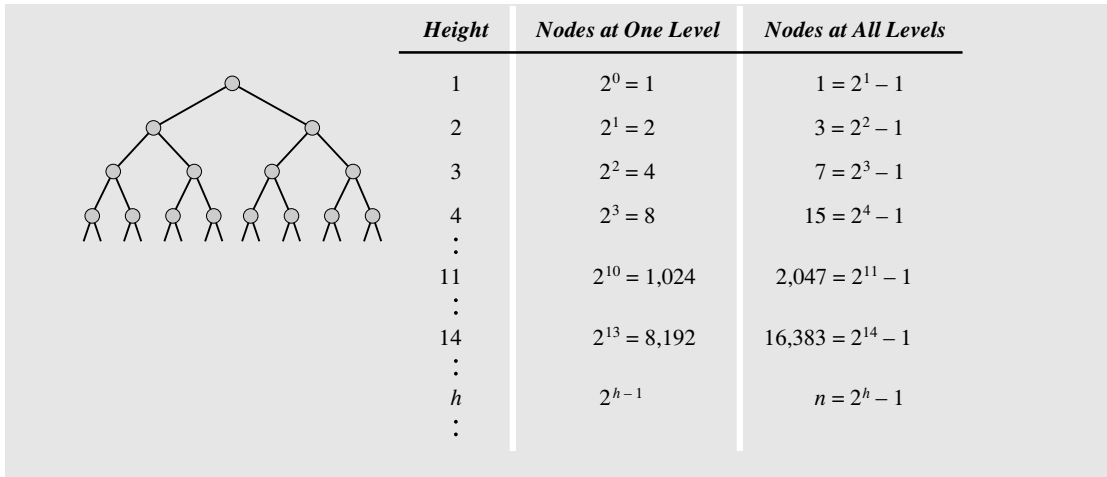
**FIGURE 6.35** Maximum number of nodes in binary trees of different heights.

Figure 6.35 shows how many nodes can be stored in binary trees of different heights. Because each node can have two children, the number of nodes on a certain level is double the number of parents residing on the previous level (except, of course, the root). For example, if 10,000 elements are stored in a perfectly balanced tree, then the tree is of height  $\lceil \lg(10,001) \rceil = \lceil 13.289 \rceil = 14$ . In practical terms, this means that if 10,000 elements are stored in a perfectly balanced tree, then at most 14 nodes have to be checked to locate a particular element. This is a substantial difference compared to the 10,000 tests needed in a linked list (in the worst case). Therefore, it is worth the effort to build a balanced tree or modify an existing tree so that it is balanced.

There are a number of techniques to properly balance a binary tree. Some of them consist of constantly restructuring the tree when elements arrive and lead to an unbalanced tree. Some of them consist of reordering the data themselves and then building a tree, if an ordering of the data guarantees that the resulting tree is balanced. This section presents a simple technique of this kind.

The linked listlike tree of Figure 6.34c is the result of a particular stream of data. Thus, if the data arrive in ascending or descending order, then the tree resembles a linked list. The tree in Figure 6.34b is lopsided because the first element that arrived was the letter B, which precedes almost all other letters, except A; the left subtree of B is guaranteed to have just one node. The tree in Figure 6.34a looks very good, because the root contains an element near the middle of all the possible elements, and P is more or less in the middle of K and Z. This leads us to an algorithm based on binary search technique.

When data arrive, store all of them in an array. After all the data arrive, sort the array using one of the efficient algorithms discussed in Chapter 9. Now, designate for the root the middle element in the array. The array now consists of two subarrays: one between the beginning of the array and the element just chosen for the root and one between the root and the end of the array. The left child of the root is taken from the middle of the first subarray, its right child an element in the middle of the second subarray. In this way, building the level of the children of the root is finished. The next



This algorithm has one serious drawback: All data must be put in an array before the tree can be created. They can be stored in the array directly from the input. In this case, the algorithm may be unsuitable when the tree has to be used while the data to be included in the tree are still coming. But the data can be transferred from an unbalanced tree to the array using inorder traversal. The tree can now be deleted and re-created using `balance()`. This, at least, does not require using any sorting algorithm to put data in order.

### 6.7.1 The DSW Algorithm

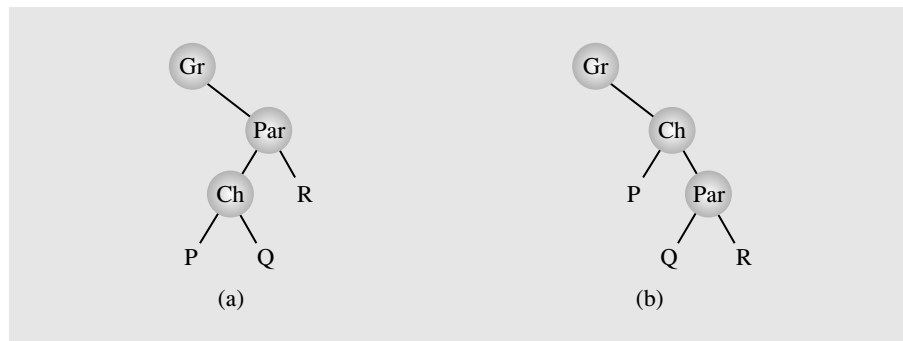
The algorithm discussed in the previous section was somewhat inefficient in that it required an additional array that needed to be sorted before the construction of a perfectly balanced tree began. To avoid sorting, it required deconstructing the tree after placing elements in the array using the inorder traversal, and then reconstructing the tree, which is inefficient except for relatively small trees. There are, however, algorithms that require little additional storage for intermediate variables and use no sorting procedure. The very elegant DSW algorithm was devised by Colin Day and later improved by Quentin F. Stout and Bette L. Warren.

The building block for tree transformations in this algorithm is the *rotation*. There are two types of rotation, left and right, which are symmetrical to one another. The right rotation of the node `Ch` about its parent `Par` is performed according to the following algorithm:

```
rotateRight (Gr, Par, Ch)
  if Par is not the root of the tree // i.e., if Gr is not null
    grandparent Gr of child Ch becomes Ch's parent;
    right subtree of Ch becomes left subtree of Ch's parent Par;
    node Ch acquires Par as its right child;
```

The steps involved in this compound operation are shown in Figure 6.37. The third step is the core of the rotation, when `Par`, the parent node of child `Ch`, becomes

**FIGURE 6.37** Right rotation of child `Ch` about parent `Par`.



the child of *Ch*, when the roles of a parent and its child change. However, this exchange of roles cannot affect the principal property of the tree, namely, that it is a search tree. The first and the second steps of `rotateRight()` are needed to ensure that, after the rotation, the tree remains a search tree.

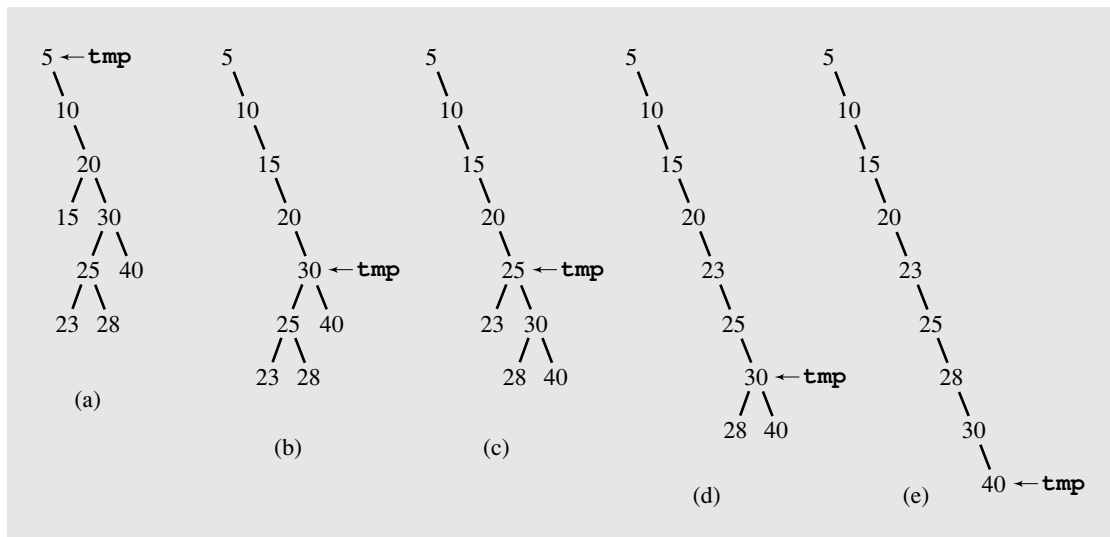
Basically, the DSW algorithm transfigures an arbitrary binary search tree into a linked listlike tree called a *backbone* or *vine*. Then this elongated tree is transformed in a series of passes into a perfectly balanced tree by repeatedly rotating every second node of the backbone about its parent.

In the first phase, a backbone is created using the following routine:

```
createBackbone(root, n)
  tmp = root;
  while (tmp != null)
    if tmp has a left child
      rotate this child about tmp; // hence the left child
                                  // becomes parent of tmp;
      set tmp to the child that just became parent;
    else set tmp to its right child;
```

This algorithm is illustrated in Figure 6.38. Note that a rotation requires knowledge about the parent of `tmp`, so another reference has to be maintained when implementing the algorithm.

**FIGURE 6.38** Transforming a binary search tree into a backbone.



In the best case, when the tree is already a backbone, the `while` loop is executed  $n$  times and no rotation is performed. In the worst case, when the root does not have a right child, the `while` loop is executed  $2n - 1$  times with  $n - 1$  rotations performed,

where  $n$  is the number of nodes in the tree; that is, the run time of the first phase is  $O(n)$ . In this case, for each node except the one with the smallest value, the left child of  $\text{tmp}$  is rotated about  $\text{tmp}$ . After all rotations are finished,  $\text{tmp}$  refers to the root, and after  $n$  iterations, it descends down the backbone to become null.

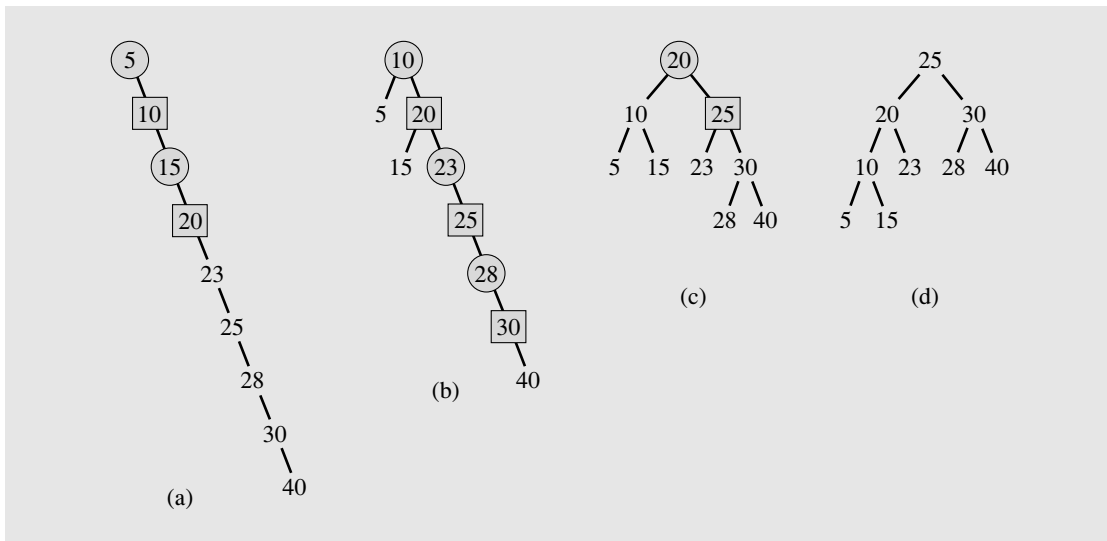
In the worst case, the `while` loop is executed  $2n - 1$  times with  $n - 1$  rotations performed where  $n$  is the number of nodes in the tree; the run time of the first phase is  $O(n)$ .

In the second phase, the backbone is transformed into a tree, but this time, the tree is perfectly balanced by having leaves only on two adjacent levels. In each pass down the backbone, every second node down to a certain point is rotated about its parent. The first pass may not reach the end of the backbone: It is used to account for the difference between the number  $n$  of nodes in the current tree and the number  $2^{\lfloor \lg(n+1) \rfloor} - 1$  of nodes in the closest complete binary tree where  $\lfloor x \rfloor$  is the closest integer less than  $x$ . That is, the overflowing nodes are treated separately.

```
createPerfectTree(n)
  m = 2⌊lg(n+1)⌋ - 1;
  make n-m rotations starting from the top of backbone;
  while (m > 1)
    m = m/2;
    make m rotations starting from the top of backbone;
```

Figure 6.39 contains an example. The backbone in Figure 6.38e has nine nodes and is preprocessed by one pass outside the loop to be transformed into the backbone shown in Figure 6.39b. Now, two passes are executed. In each backbone, the nodes to

**FIGURE 6.39** Transforming a backbone into a perfectly balanced tree.





be promoted by one level by left rotations are shown as squares; their parents, about which they are rotated, are circles.

To compute the complexity of the tree building phase, observe that the number of iterations performed by the `while` loop equals

$$(2^{\lg(m+1)-1} - 1) + \dots + 15 + 7 + 3 + 1 = \sum_{i=1}^{\lg(m+1)-1} (2^i - 1) = m - \lg(m + 1)$$

The number of rotations can now be given by the formula

$$n - m + (m - \lg(m + 1)) = n - \lg(m + 1) = n - \lfloor \lg(n + 1) \rfloor$$

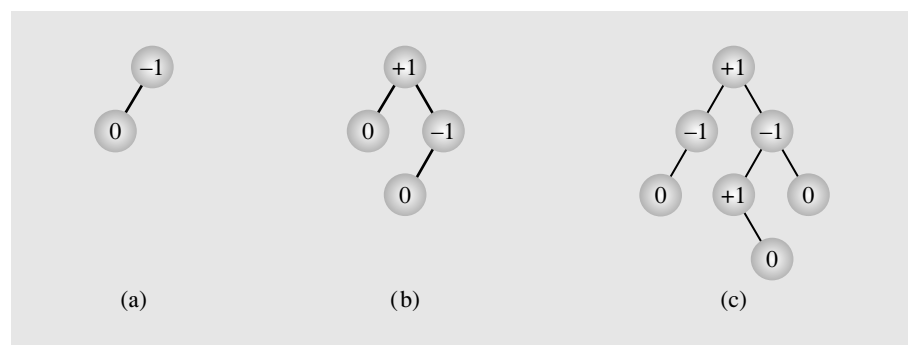
that is, the number of rotations is  $O(n)$ . Because creating a backbone also required at most  $O(n)$  rotations, the cost of global rebalancing with the DSW algorithm is optimal in terms of time because it grows linearly with  $n$  and requires a very small and fixed amount of additional storage.

## 6.7.2 AVL Trees

The previous two sections discussed algorithms that rebalanced the tree globally; each and every node could have been involved in rebalancing either by moving data from nodes or by reassigning new values to reference fields. Tree rebalancing, however, can be performed locally if only a portion of the tree is affected when changes are required after an element is inserted into or deleted from the tree. One classical method has been proposed by Adel'son-Vel'skii and Landis, which is commemorated in the name of the tree modified with this method: the AVL tree.

An *AVL tree* (originally called an *admissible tree*) is one in which the height of the left and right subtrees of every node differ by at most one. For example, all the trees in Figure 6.40 are AVL trees. Numbers in the nodes indicate the *balance factors* that are the differences between the heights of the left and right subtrees. A balance factor is the height of the right subtree minus the height of the left subtree. For an AVL tree, all

**FIGURE 6.40** Examples of AVL trees.



balance factors should be +1, 0, or -1. Notice that the definition of the AVL tree is the same as the definition of the balanced tree. However, the concept of the AVL tree always implicitly includes the techniques for balancing the tree. Moreover, unlike the two methods previously discussed, the technique for balancing AVL trees does not guarantee that the resulting tree is perfectly balanced.

The definition of an AVL tree indicates that the minimum number of nodes in a tree is determined by the recurrence equation

$$AVL_h = AVL_{h-1} + AVL_{h-2} + 1$$

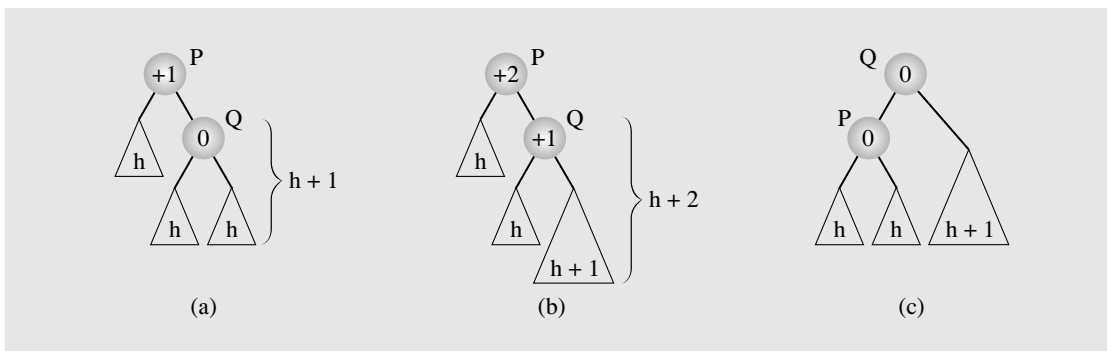
where  $AVL_0 = 0$  and  $AVL_1 = 1$  are the initial conditions.<sup>1</sup> This formula leads to the following bounds on the height  $h$  of an AVL tree depending on the number of nodes  $n$  (see Appendix A.5):

$$\lg(n + 1) \leq h < 1.44\lg(n + 2) - 0.328$$

Therefore,  $h$  is bounded by  $O(\lg n)$ ; the worst case search requires  $O(\lg n)$  comparisons. For a perfectly balanced binary tree of the same height,  $h = \lceil \lg(n + 1) \rceil$ . Therefore, the search time in the worst case in an AVL tree is 44% worse (it requires 44% more comparisons) than in the best case tree configuration. Empirical studies indicate that the average number of searches is much closer to the best case than to the worst and is equal to  $\lg n + 0.25$  for large  $n$  (Knuth 1998). Therefore, AVL trees are definitely worth studying.

If the balance factor of any node in an AVL tree becomes less than -1 or greater than 1, the tree has to be balanced. An AVL tree can become out of balance in four situations, but only two of them need to be analyzed; the remaining two are symmetrical. The first case, the result of inserting a node in the right subtree of the right child, is illustrated in Figure 6.41. The heights of the participating subtrees are indicated within these subtrees. In the AVL tree in Figure 6.41a, a node is inserted somewhere in the right subtree of  $Q$  (Figure 6.41b), which disturbs the balance of the tree  $P$ . In this case, the prob-

**FIGURE 6.41** Balancing a tree after insertion of a node in the right subtree of node  $Q$ .

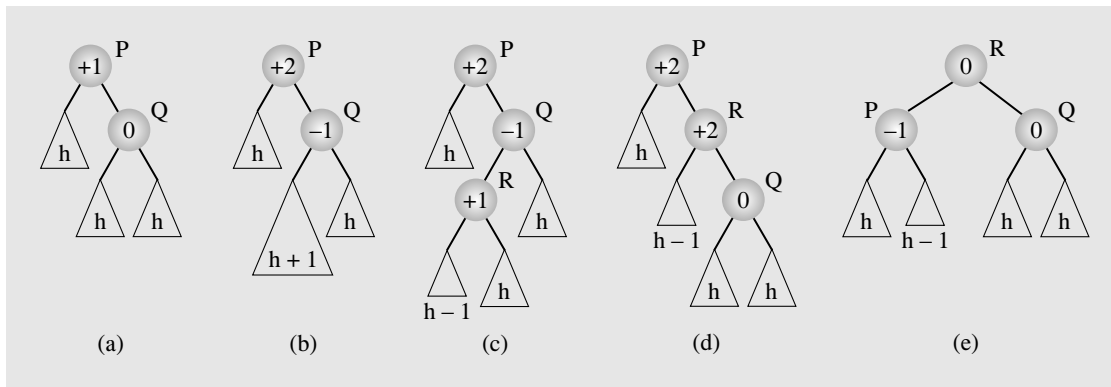


<sup>1</sup>Numbers generated by this reference formula are called *Leonardo numbers*.

lem can be easily rectified by rotating node  $Q$  about its parent  $P$  (Figure 6.41c) so that the balance factor of both  $P$  and  $Q$  becomes zero, which is even better than at the outset.

The second case, the result of inserting a node in the left subtree of the right child, is more complex. A node is inserted into the tree in Figure 6.42a; the resulting tree is shown in Figure 6.42b and in more detail in Figure 6.42c. Note that  $R$ 's balance factor can also be  $-1$ . To bring the tree back into balance, a double rotation is performed. The balance of the tree  $P$  is restored by rotating  $R$  about node  $Q$  (Figure 6.42d) and then by rotating  $R$  again, this time about node  $P$  (Figure 6.42e).

**FIGURE 6.42** Balancing a tree after insertion of a node in the left subtree of node  $Q$ .

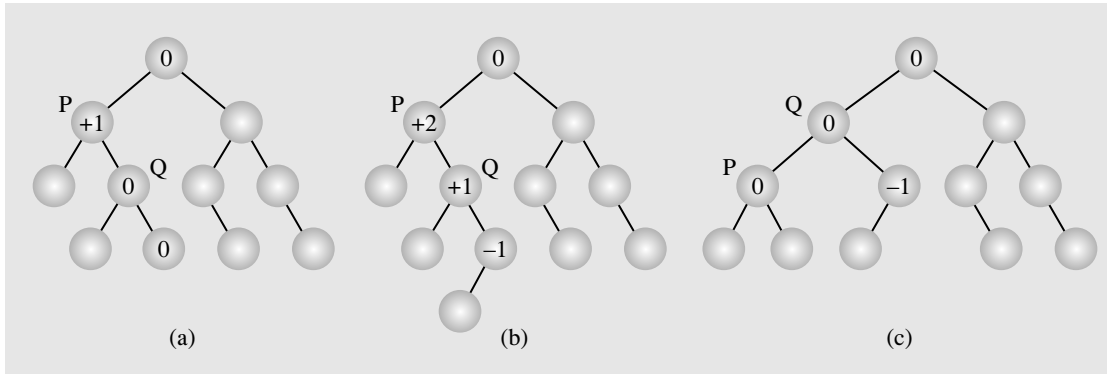


In these two cases, the tree  $P$  is considered a stand-alone tree. However,  $P$  can be part of a larger AVL tree; it can be a child of some other node in the tree. If a node is entered into the tree and the balance of  $P$  is disturbed and then restored, does extra work need to be done to the predecessor(s) of  $P$ ? Fortunately not. Note that the heights of the trees in Figures 6.41c and 6.42e resulting from the rotations are the same as the heights of the trees before insertion (Figures 6.41a and 6.42a) and are equal to  $h + 2$ . This means that the balance factor of the parent of the new root ( $Q$  in Figure 6.41c and  $R$  in Figure 6.42e) remains the same as it was before the insertion, and the changes made to the subtree  $P$  are sufficient to restore the balance of the entire AVL tree. The problem is in finding a node  $P$  for which the balance factor becomes unacceptable after a node has been inserted into the tree.

This node can be detected by moving up toward the root of the tree from the position in which the new node has been inserted and by updating the balance factors of the nodes encountered. Then, if a node with a  $\pm 1$  balance factor is encountered, the balance factor may be changed to  $\pm 2$ , and the first node whose balance factor is changed in this way becomes the root  $P$  of a subtree for which the balance has to be restored. Note that the balance factors do not have to be updated above this node because they remain the same.

In Figure 6.43a, a path is marked with one balance factor equal to  $+1$ . Insertion of a new node at the end of this path results in an unbalanced tree (Figure 6.43b), and the balance is restored by one left rotation (Figure 6.43c).

**FIGURE 6.43** An example of inserting a new node (b) in an AVL tree (a), which requires one rotation (c) to restore the height balance.

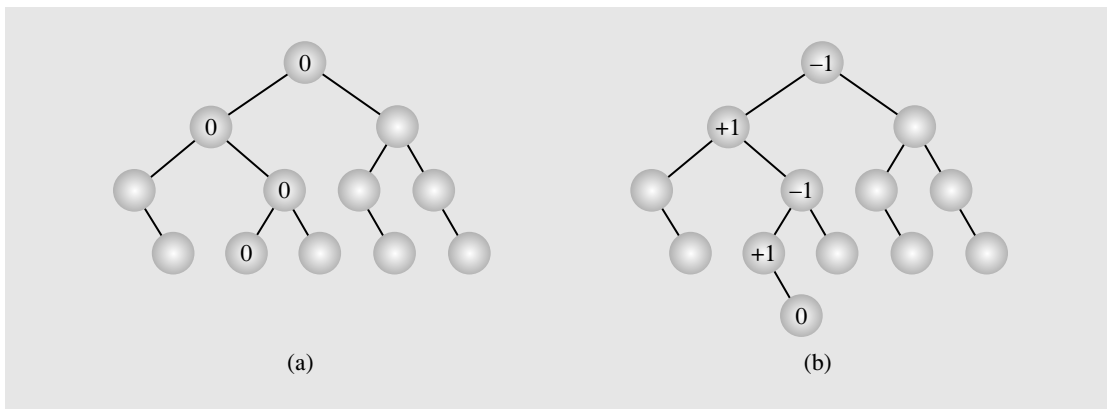


However, if the balance factors on the path from the newly inserted node to the root of the tree are all zero, all of them have to be updated, but no rotation is needed for any of the encountered nodes. In Figure 6.44a, the AVL tree has a path of all zero balance factors. After a node has been appended to the end of this path (Figure 6.44b), no changes are made in the tree except for updating the balance factors of all nodes along this path.

Deletion may be more time-consuming than insertion. First, we can apply `deleteByCopying()` to delete a node. This technique allows us to reduce the problem of deleting a node with two descendants to deleting a node with at most one descendant.

After a node has been deleted from the tree, balance factors are updated from the parent of the deleted node up to the root. For each node in this path whose balance factor becomes  $\pm 2$ , a single or double rotation has to be performed to restore the balance of the tree. Importantly, the rebalancing does not stop after the first node *P* is found for

**FIGURE 6.44** In an AVL tree (a) a new node is inserted (b) requiring no height adjustments.

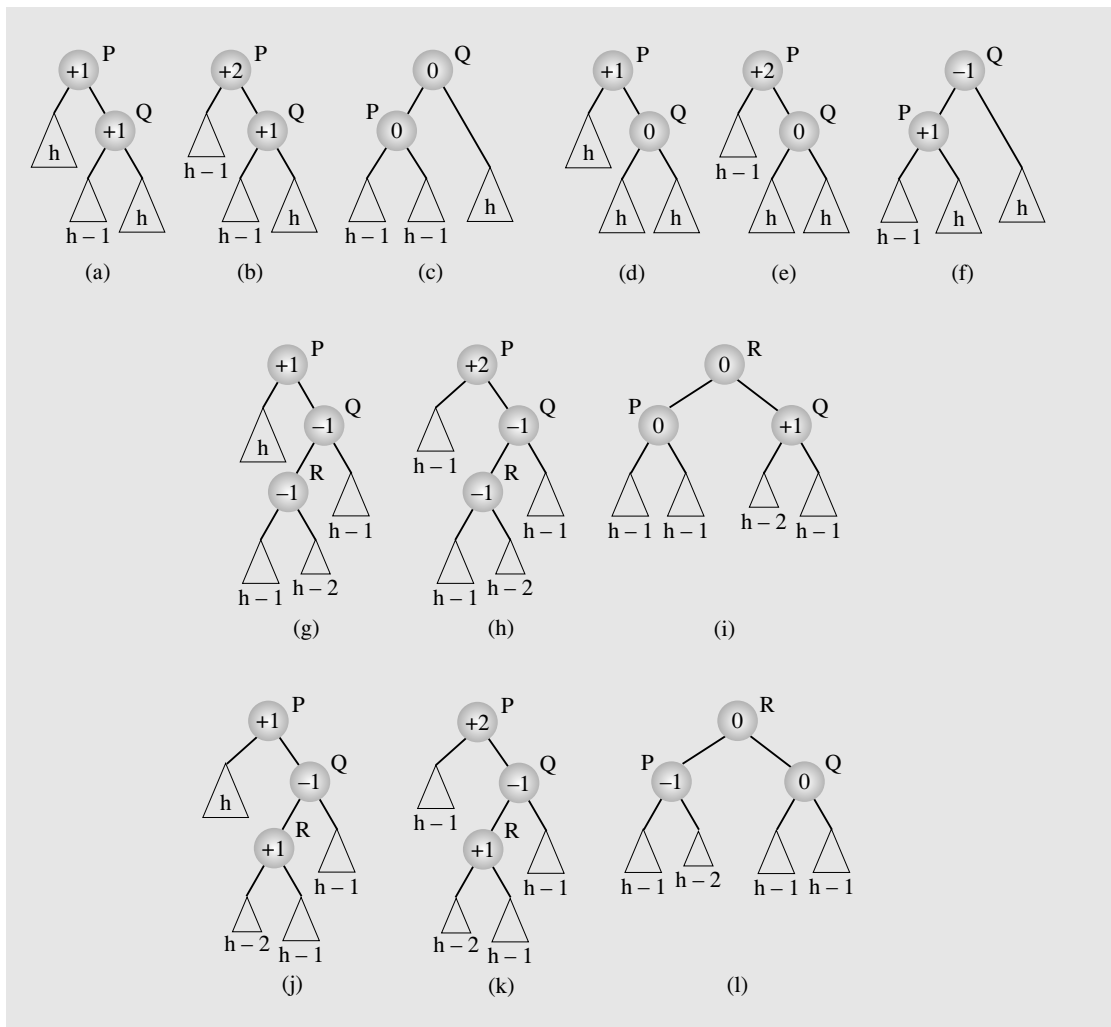


which the balance factor would become  $\pm 2$ , as is the case with insertion. This also means that deletion leads to at most  $O(\lg n)$  rotations, because in the worst case, every node on the path from the deleted node to the root may require rebalancing.

Deletion of a node does not have to necessitate an immediate rotation because it may improve the balance factor of its parent (by changing it from  $\pm 1$  to 0), but it may also worsen the balance factor for the grandparent (by changing it from  $\pm 1$  to  $\pm 2$ ). We illustrate only those cases that require immediate rotation. There are four such cases (plus four symmetric cases). In each of these cases, we assume that the left child of node  $P$  is deleted.

In the first case, the tree in Figure 6.45a turns, after deleting a node, into the tree in Figure 6.45b. The tree is rebalanced by rotating  $Q$  about  $P$  (Figure 6.45c). In the

**FIGURE 6.45** Rebalancing an AVL tree after deleting a node.



second case,  $P$  has a balance factor equal to +1, and its right subtree  $Q$  has a balance factor equal to 0 (Figure 6.45d). After deleting a node in the left subtree of  $P$  (Figure 6.45e), the tree is rebalanced by the same rotation as in the first case (Figure 6.45f). In this way, cases one and two can be processed together in an implementation after checking that the balance factor of  $Q$  is +1 or 0. If  $Q$  is -1, we have two other cases, which are more complex. In the third case, the left subtree  $R$  of  $Q$  has a balance factor equal to -1 (Figure 6.45g). To rebalance the tree, first  $R$  is rotated about  $Q$  and then about  $P$  (Figures 6.45h-i). The fourth case differs from the third in that  $R$ 's balance factor equals +1 (Figure 6.45j), in which case the same two rotations are needed to restore the balance factor of  $P$  (Figures 6.45k-l). Cases three and four can be processed together in a program processing AVL trees.

The previous analyses indicate that insertions and deletions require at most  $1.44 \lg(n+2)$  searches. Also, insertion can require one single or one double rotation, and deletion can require  $1.44 \lg(n+2)$  rotations in the worst case. But as also indicated, the average case requires  $\lg(n) + .25$  searches, which reduces the number of rotations in case of deletion to this number. To be sure, insertion in the average case may lead to one single/double rotation. Experiments also indicate that deletions in 78% of cases require no rebalancing at all. On the other hand, only 53% of insertions do not bring the tree out of balance (Karlton et al. 1976). Therefore, the more time-consuming deletion occurs less frequently than the insertion operation, not markedly endangering the efficiency of rebalancing AVL trees.

AVL trees can be extended by allowing the difference in height  $\Delta > 1$  (Foster, 1973). Not unexpectedly, the worst-case height increases with  $\Delta$  and

$$h = \begin{cases} 1.81 \lg(n) - 0.71 & \text{if } \Delta = 2 \\ 2.15 \lg(n) - 1.13 & \text{if } \Delta = 3 \end{cases}$$

As experiments indicate, the average number of visited nodes increases by one-half in comparison to pure AVL trees ( $\Delta = 1$ ), but the amount of restructuring can be decreased by a factor of 10.

## 6.8 SELF-ADJUSTING TREES

The main concern in balancing trees is to keep them from becoming lopsided and, ideally, to allow leaves to occur only at one or two levels. Therefore, if a newly arriving element endangers the tree balance, the problem is immediately rectified by restructuring the tree locally (the AVL method) or by re-creating the tree (the DSW method). However, we may question whether such a restructuring is always necessary. Binary search trees are used to insert, retrieve, and delete elements quickly, and the speed of performing these operations is the issue, not the shape of the tree. Performance can be improved by balancing the tree, but this is not the only method that can be used.

Another approach begins with the observation that not all elements are used with the same frequency. For example, if an element on the tenth level of the tree is used only infrequently, then the execution of the entire program is not greatly impaired by accessing this level. However, if the same element is constantly being accessed, then it makes a big difference whether it is on the tenth level or close to the root. Therefore, the strategy in

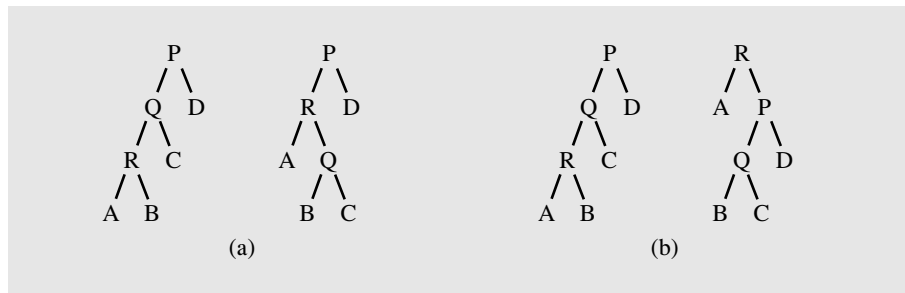
self-adjusting trees is to restructure trees by moving up the tree only those elements that are used more often, creating a kind of “priority tree.” The frequency of accessing nodes can be determined in a variety of ways. Each node can have a counter field that records the number of times the element has been used for any operation. Then the tree can be scanned to move the most frequently accessed elements toward the root. In a less sophisticated approach, it is assumed that an element being accessed has a good chance of being accessed again soon. Therefore, it is moved up the tree. No restructuring is performed for new elements. This assumption may lead to promoting elements that are occasionally accessed, but the overall tendency is to move up elements with a high frequency of access, and for the most part, these elements will populate the first few levels of the tree.

### 6.8.1 Self-Restructuring Trees

A strategy proposed by Brian Allen and Ian Munro and by James Bitner consists of two possibilities:

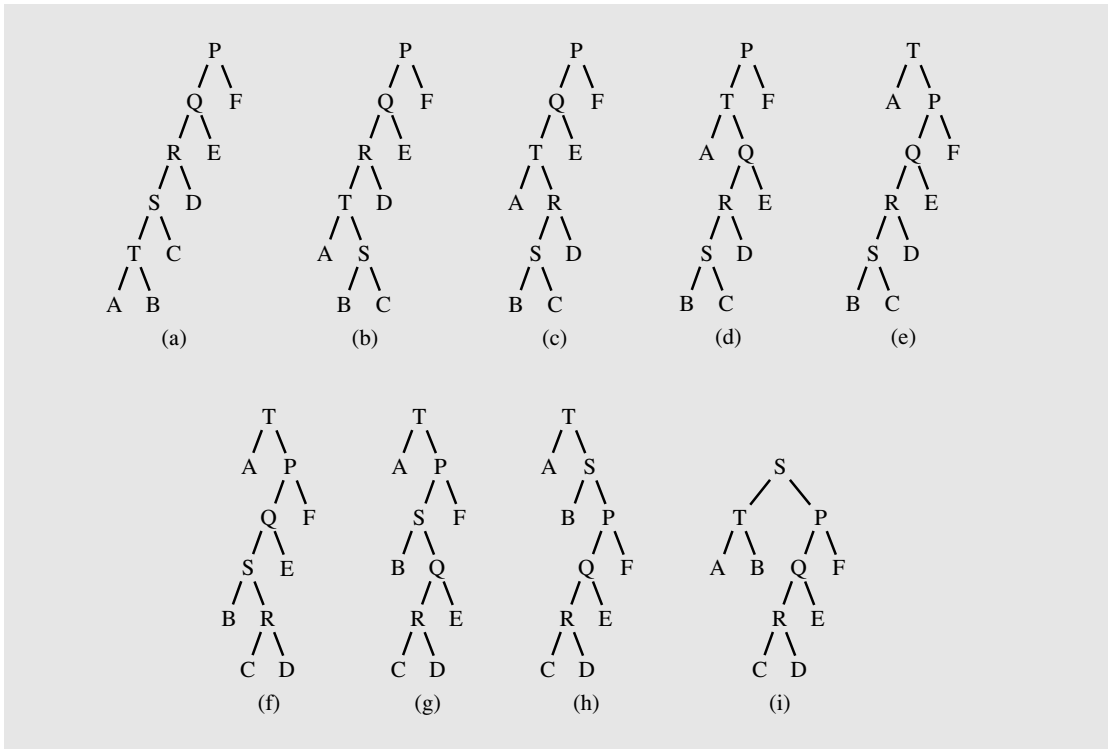
1. *Single rotation.* Rotate a child about its parent if an element in a child is accessed, unless it is the root (Figure 6.46a).
2. *Moving to the root.* Repeat the child–parent rotation until the element being accessed is in the root (Figure 6.46b).

**FIGURE 6.46** Restructuring a tree by using (a) a single rotation or (b) moving to the root when accessing node R.



Using the single rotation strategy, frequently accessed elements are eventually moved up close to the root so that later accesses are faster than previous ones. In the move-to-the-root strategy, it is assumed that the element being accessed has a high probability to be accessed again, so it percolates right away up to the root. Even if it is not used in the next access, the element remains close to the root. These strategies, however, do not work very well in unfavorable situations, when the binary tree is elongated as in Figure 6.47. In this case, the shape of the tree improves slowly. Nevertheless, it has been determined that the cost of moving a node to the root converges to the cost of accessing the node in an optimal tree times  $2 \ln 2$ ; that is, it converges to

**FIGURE 6.47** (a–e) Moving element *T* to the root and then (e–i) moving element *S* to the root.



$(2 \ln 2) \lg n$ . The result holds for any probability distribution (that is, independently of the probability that a particular request is issued). However, the average search time when all requests are equally likely is, for the single rotation technique, equal to  $\sqrt{\pi n}$ .

### 6.8.2 Splaying

A modification of the move-to-the-root strategy is called *splaying*, which applies single rotations in pairs in an order depending on the links between the child, parent, and grandparent (Sleator and Tarjan 1985). First, three cases are distinguished depending on the relationship between a node *R* being accessed and its parent *Q* and grandparent *P* (if any) nodes:

**Case 1:** Node *R*'s parent is the root.

**Case 2:** *Homogeneous configuration.* Node *R* is the left child of its parent *Q*, and *Q* is the left child of its parent *P*, or *R* and *Q* are both right children.

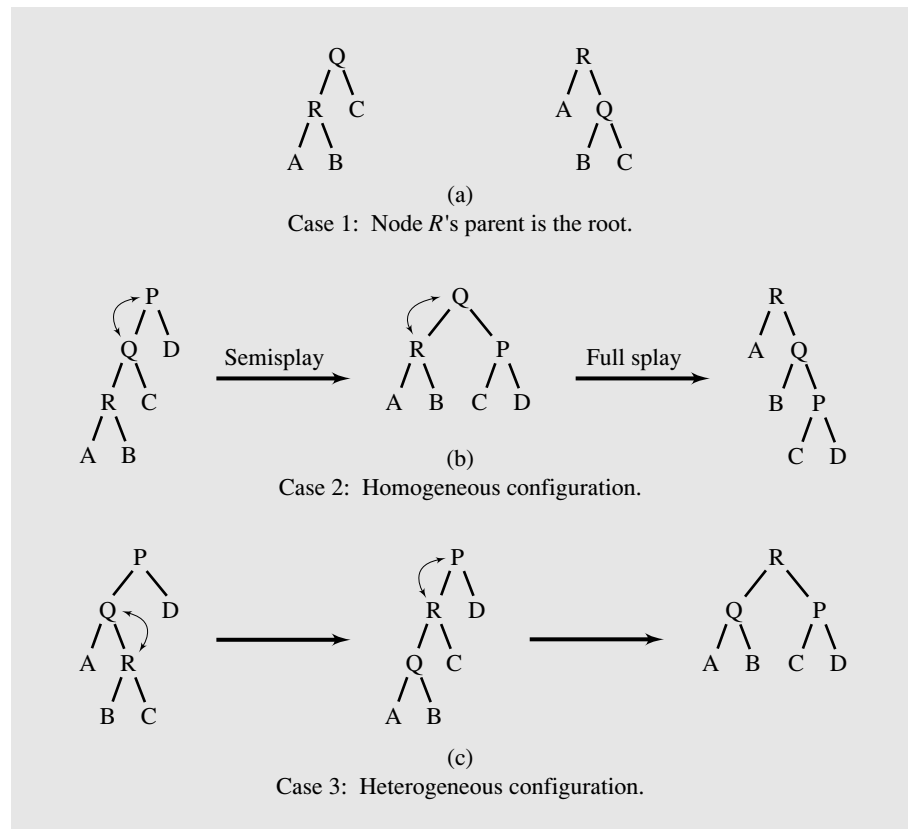


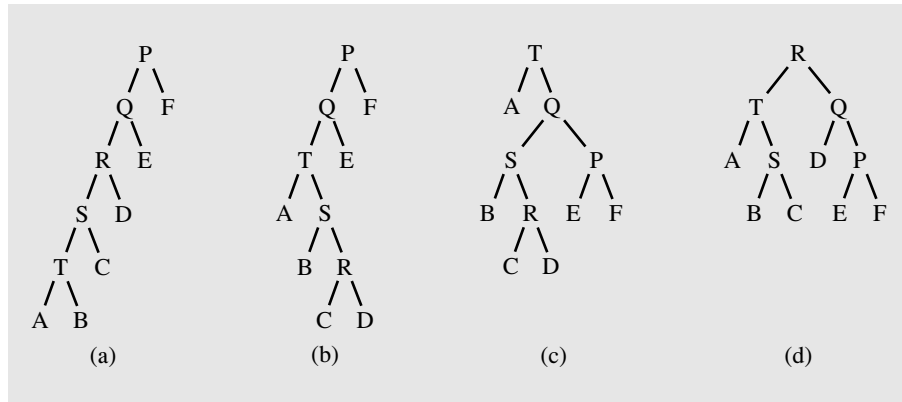
**Case 3: Heterogeneous configuration.** Node *R* is the right child of its parent *Q*, and *Q* is the left child of its parent *P*, or *R* is the left child of *Q*, and *Q* is the right child of *P*.

The algorithm to move a node *R* being accessed to the root of the tree is as follows:

```
splaying(P,Q,R)
while R is not the root
  if R's parent is the root
    perform a singular splay, rotate R about its parent (Figure 6.48a);
  else if R is in a homogeneous configuration with its predecessors
    perform a homogeneous splay, first rotate Q about P
    and then R about Q (Figure 6.48b);
  else // if R is in a heterogeneous configuration
    // with its predecessors
    perform a heterogeneous splay, first rotate R about Q
    and then about P (Figure 6.48c);
```

**FIGURE 6.48** Examples of splaying.



**FIGURE 6.49** Restructuring a tree with splaying (a–c) after accessing  $T$  and (c–d) then  $R$ .

The difference in restructuring a tree is illustrated in Figure 6.49, where the tree from Figure 6.47a is used to access node  $T$  located at the fifth level. The shape of the tree is immediately improved. Then, node  $R$  is accessed (Figure 6.49c) and the shape of the tree becomes even better (Figure 6.49d).

Although splaying is a combination of two rotations except when next to the root, these rotations are not always used in the bottom-up fashion, as in self-adjusting trees. For the homogeneous case (left-left or right-right), first the parent and the grandparent of the node being accessed are rotated, and only afterward are the node and its parent rotated. This has the effect of moving an element to the root and flattening the tree, which has a positive impact on the accesses to be made.

The number of rotations may seem excessive, and it certainly would be if an accessed element happened to be in a leaf every time. In the case of a leaf, the access time is usually  $O(\lg n)$ , except for some initial accesses when the tree is not balanced. But accessing elements close to the root may make the tree unbalanced. For example, in the tree in Figure 6.49a, if the left child of the root is always accessed, then eventually, the tree would also be elongated, this time extending to the right.

To establish the efficiency of accessing a node in a binary search tree that utilizes the splaying technique, an amortized analysis will be used.

Consider a binary search tree  $t$ . Let  $nodes(x)$  be the number of nodes in the subtree whose root is  $x$ ,  $rank(x) = \lg(nodes(x))$ , so that  $rank(root(t)) = \lg(n)$ , and  $potential(t) = \sum_{x \text{ is a node of } t} rank(x)$ . It is clear that  $nodes(x) + 1 \leq nodes(parent(x))$ ; therefore,  $rank(x) < rank(parent(x))$ . Let the amortized cost of accessing node  $x$  be defined as the function

$$amCost(x) = cost(x) + potential_s(t) - potential_0(t)$$

where  $potential_s(t)$  and  $potential_0(t)$  are the potentials of the tree before access takes place and after it is finished. It is very important to see that one rotation changes ranks of only the node  $x$  being accessed, its parent, and its grandparent. This is the reason for basing the definition of the amortized cost of accessing node  $x$  on the change in

the potential of the tree, which amounts to the change of ranks of the nodes involved in splaying operations that promote  $x$  to the root. We can state now a lemma specifying the amortized cost of one access.

**Access lemma** (Sleator and Tarjan 1985). For the amortized time to splay the tree  $t$  at a node  $x$ ,

$$amCost(x) < 3(\lg(n) - rank(x)) + 1$$

The proof of this conjecture is divided into three parts, each dealing with the different case indicated in Figure 6.48. Let  $par(x)$  be a parent of  $x$  and  $gpar(x)$  a grandparent of  $x$  (in Figure 6.48,  $x = R$ ,  $par(x) = Q$ , and  $gpar(x) = P$ ).

**Case 1:** One rotation is performed. This can be only the last splaying step in the sequence of such steps that move node  $x$  to the root of the tree  $t$ , and if there are a total of  $s$  splaying steps in the sequence, then the amortized cost of the last splaying step  $s$  is

$$\begin{aligned} amCost_s(x) &= cost_s(x) + potential_s(t) - potential_{s-1}(t) \\ &= 1 + (rank_s(x) - rank_{s-1}(x)) + (rank_s(par(x)) - rank_{s-1}(par(x))) \end{aligned}$$

where  $cost_s(x) = 1$  represents the actual cost, the cost of the one splaying step (which in this step is limited to one rotation);  $potential_{s-1}(t) = rank_{s-1}(x) + rank_{s-1}(par(x)) + C$  and  $potential_s(t) = rank_s(x) + rank_s(par(x)) + C$ , because  $x$  and  $par(x)$  are the only nodes whose ranks are modified. Now because  $rank_s(x) = rank_{s-1}(par(x))$

$$amCost_s(x) = 1 - rank_{s-1}(x) + rank_s(par(x))$$

and because  $rank_s(par(x)) < rank_s(x)$

$$amCost_s(x) < 1 - rank_{s-1}(x) + rank_s(x).$$

**Case 2:** Two rotations are performed during a homogeneous splay. As before, number 1 represents the actual cost of one splaying step.

$$amCost_i(x) = 1 + (rank_i(x) - rank_{i-1}(x)) + (rank_i(par(x)) - rank_{i-1}(par(x))) + (rank_i(gpar(x)) - rank_{i-1}(gpar(x)))$$

Because  $rank_i(x) = rank_{i-1}(gpar(x))$

$$amCost_i(x) = 1 - rank_{i-1}(x) + rank_i(par(x)) - rank_{i-1}(par(x)) + rank_i(gpar(x))$$

Because  $rank_i(gpar(x)) < rank_i(par(x)) < rank_i(x)$

$$amCost_i(x) < 1 - rank_{i-1}(x) - rank_{i-1}(par(x)) + 2rank_i(x)$$

and because  $rank_{i-1}(x) < rank_{i-1}(par(x))$ , that is,  $-rank_{i-1}(par(x)) < -rank_{i-1}(x)$

$$amCost_i(x) < 1 - 2rank_{i-1}(x) + 2rank_i(x).$$

To eliminate number 1, consider the inequality  $rank_{i-1}(x) < rank_{i-1}(gpar(x))$ ; that is,  $1 \leq rank_{i-1}(gpar(x)) - rank_{i-1}(x)$ . From this, we obtain

$$\begin{aligned} amCost_i(x) &< rank_{i-1}(gpar(x)) - rank_{i-1}(x) - 2rank_{i-1}(x) + 2rank_i(x) \\ amCost_i(x) &< rank_{i-1}(gpar(x)) - 3rank_{i-1}(x) + 2rank_i(x) \end{aligned}$$

and because  $rank_i(x) = rank_{i-1}(gpar(x))$

$$amCost_i(x) < -3rank_{i-1}(x) + 3rank_i(x)$$

**Case 3:** Two rotations are performed during a heterogeneous splay. The only difference in this proof is making the assumption that  $rank_i(gpar(x)) < rank_i(x)$  and  $rank_i(par(x)) < rank_i(x)$  instead of  $rank_i(gpar(x)) < rank_i(par(x)) < rank_i(x)$ , which renders the same result.

The total amortized cost of accessing a node  $x$  equals the sum of amortized costs of all the splaying steps executed during this access. If the number of steps equals  $s$ , then at most one (the last) step requires only one rotation (case 1) and thus

$$\begin{aligned} amCost(x) &= \sum_{i=1}^s amCost_i(x) = \sum_{i=1}^{s-1} amCost_i(x) + amCost_s(x) \\ &< \sum_{i=1}^{s-1} 3(rank_i(x) - rank_{i-1}(x)) + rank_s(x) - rank_{s-1}(x) + 1 \end{aligned}$$

Because  $rank_s(x) > rank_{s-1}(x)$ ,

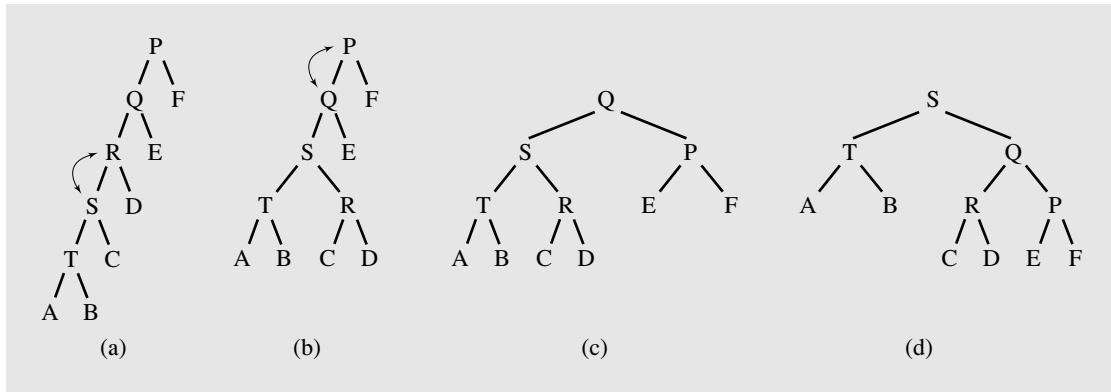
$$\begin{aligned} amCost(x) &< \sum_{i=1}^{s-1} 3(rank_i(x) - rank_{i-1}(x)) + 3(rank_s(x) - rank_{s-1}(x)) + 1 \\ &= 3(rank_s(x) - rank_0(x)) + 1 = 3(\lg n - rank_0(x)) + 1 = O(\lg n) \end{aligned}$$

This indicates that the amortized cost of an access to a node in a tree that is restructured with the splaying technique equals  $O(\lg n)$ , which is the same as the worst case in balanced trees. However, to make the comparison more adequate, we should compare a sequence of  $m$  accesses to nodes rather than one access because, with the amortize cost, one isolated access can still be on the order of  $O(n)$ . The efficiency of a tree that applies splaying is thus comparable to that of a balanced tree for a sequence of accesses and equals  $O(m \lg n)$ .  $\square$

Splaying is a strategy focusing upon the elements rather than the shape of the tree. It may perform well in situations in which some elements are used much more frequently than others. If elements near the root are accessed with about the same frequency as elements on the lowest levels, then splaying may not be the best choice. In this case, a strategy that stresses balancing the tree rather than frequency is better; a modification of the splaying method is a more viable option.

*Semisplaying* is a modification that requires only one rotation for a homogeneous splay and continues splaying with the parent of the accessed node, not with the node itself. It is illustrated in Figure 6.48b. After  $R$  is accessed, its parent  $Q$  is rotated about  $P$  and splaying continues with  $Q$ , not with  $R$ . A rotation of  $R$  about  $Q$  is not performed, as would be the case for splaying.

Figure 6.50 illustrates the advantages of semisplaying. The elongated tree from Figure 6.49a becomes more balanced with semisplaying after accessing  $T$  (Figures 6.50a–c), and after  $T$  is accessed again, the tree in Figure 6.50d has basically the same

**FIGURE 6.50** (a–c) Accessing  $T$  and restructuring the tree with semisplaying; (c–d) accessing  $T$  again.

number of levels as the tree in Figure 6.50c. (It may have one more level if  $E$  or  $F$  was a subtree higher than any of subtrees  $A$ ,  $B$ ,  $C$ , or  $D$ .) For implementation of this tree strategy, see the case study at the end of this chapter.

It is interesting that although the theoretical bounds obtained from self-organizing trees compare favorably with the bounds for AVL trees and random binary search trees—that is, with no balancing technique applied to it—experimental runs for trees of various sizes and different ratios of accessing keys indicate that almost always the AVL tree outperforms self-adjusting trees, and many times even a regular binary search tree performs better than a self-organizing tree (Bell, Gupta 1993). At best, this result indicates that computational complexity and amortized performance should not always be considered as the only measures of algorithm performance.

## 6.9 HEAPS

A particular kind of binary tree, called a *heap*, has the following two properties:

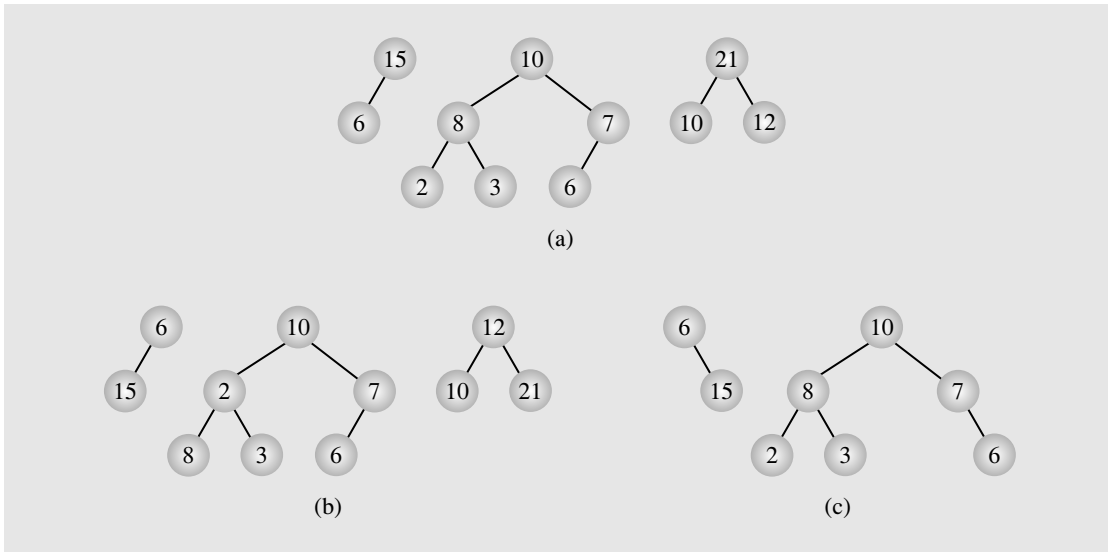
1. The value of each node is greater than or equal to the values stored in each of its children.
2. The tree is perfectly balanced, and the leaves in the last level are all in the leftmost positions.

To be exact, these two properties define a *max heap*. If “greater” in the first property is replaced with “less,” then the definition specifies a *min heap*. This means that the root of a max heap contains the largest element, whereas the root of a min heap contains the smallest. A tree has the *heap property* if each nonleaf has the first property. Due to the second condition, the number of levels in the tree is  $O(\lg n)$ .

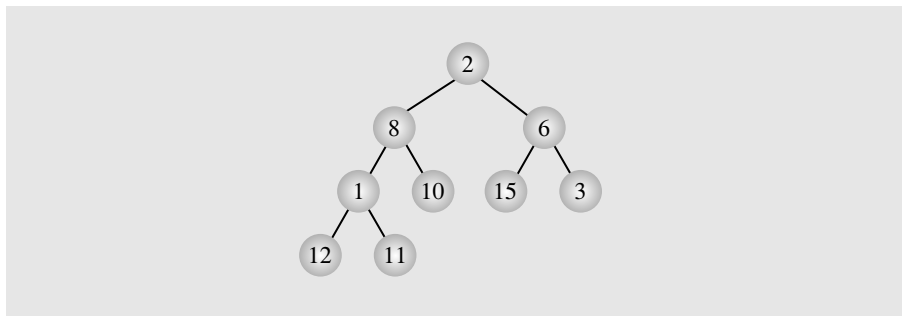
The trees in Figure 6.51a are all heaps; the trees in Figure 6.51b violate the first property, and the trees in Figure 6.51c violate the second.

Interestingly, heaps can be implemented by arrays. For example, the array `data = [2 8 6 1 10 15 3 12 11]` can represent the nonheap tree in Figure 6.52. The elements are

**FIGURE 6.51** Examples of (a) heaps and (b–c) nonheaps.



**FIGURE 6.52** The array [2 8 6 1 10 15 3 12 11] seen as a tree.



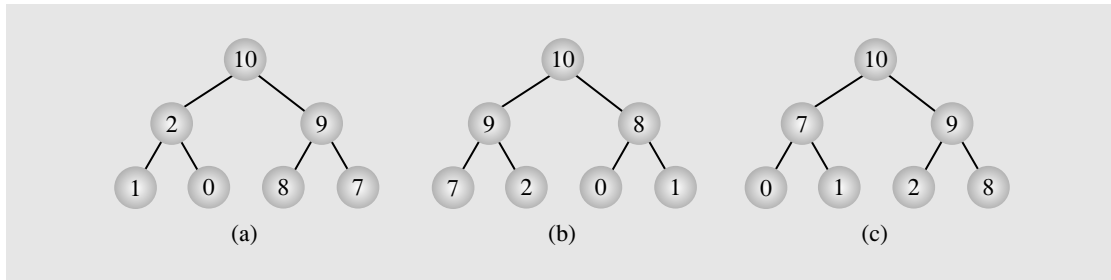
placed at sequential locations representing the nodes from top to bottom and in each level from left to right. The second property reflects the fact that the array is packed, with no gaps. Now, a heap can be defined as an array `heap` of length  $n$  in which

$$\text{heap}[i] \geq \text{heap}[2 \cdot i + 1], \text{ for } 0 \leq i < \frac{n-1}{2}$$

and

$$\text{heap}[i] \geq \text{heap}[2 \cdot i + 2], \text{ for } 0 \leq i < \frac{n-2}{2}$$

Elements in a heap are not perfectly ordered. We know only that the largest element is in the root node and that, for each node, all its descendants are less than or equal to that

**FIGURE 6.53** Different heaps constructed with the same elements.

node. But the relation between sibling nodes or, to continue the kinship terminology, between uncle and nephew nodes is not determined. The order of the elements obeys a linear line of descent, disregarding lateral lines. For this reason, all the trees in Figure 6.53 are legitimate heaps, although the heap in Figure 6.53b is ordered best.

### 6.9.1 Heaps as Priority Queues

A heap is an excellent way to implement a priority queue. Section 4.3 used linked lists to implement priority queues, structures for which the complexity was expressed in terms of  $O(n)$  or  $O(\sqrt{n})$ . For large  $n$ , this may be too ineffective. On the other hand, a heap is a perfectly balanced tree; hence, reaching a leaf requires  $O(\lg n)$  searches. This efficiency is very promising. Therefore, heaps can be used to implement priority queues. To this end, however, two procedures have to be implemented to enqueue and dequeue elements on a priority queue.

To enqueue an element, the element is added at the end of the heap as the last leaf. Restoring the heap property in the case of enqueueing is achieved by moving from the last leaf toward the root.

The algorithm for enqueueing is as follows:

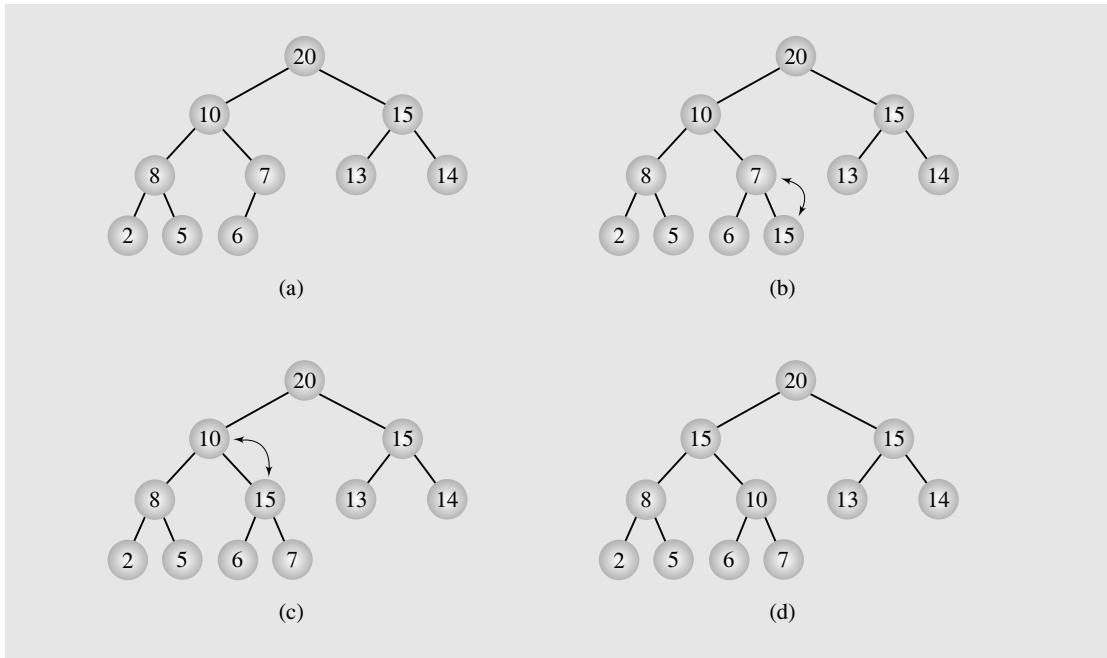
```

heapEnqueue(e1)
  put e1 at the end of heap;
  while e1 is not in the root and e1 > parent(e1)
    swap e1 with its parent;

```

For example, the number 15 is added to the heap in Figure 6.54a as the next leaf (Figure 6.54b), which destroys the heap property of the tree. To restore this property, 15 has to be moved up the tree until it either ends up in the root or finds a parent that is not less than 15. In this example, the latter case occurs, and 15 has to be moved only twice without reaching the root.

Dequeuing an element from the heap consists of removing the root element from the heap, because by the heap property it is the element with the greatest priority. Then the last leaf is put in its place, and the heap property almost certainly has to be restored, this time by moving from the root down the tree.

**FIGURE 6.54** Enqueuing an element to a heap.

The algorithm for dequeuing is as follows:

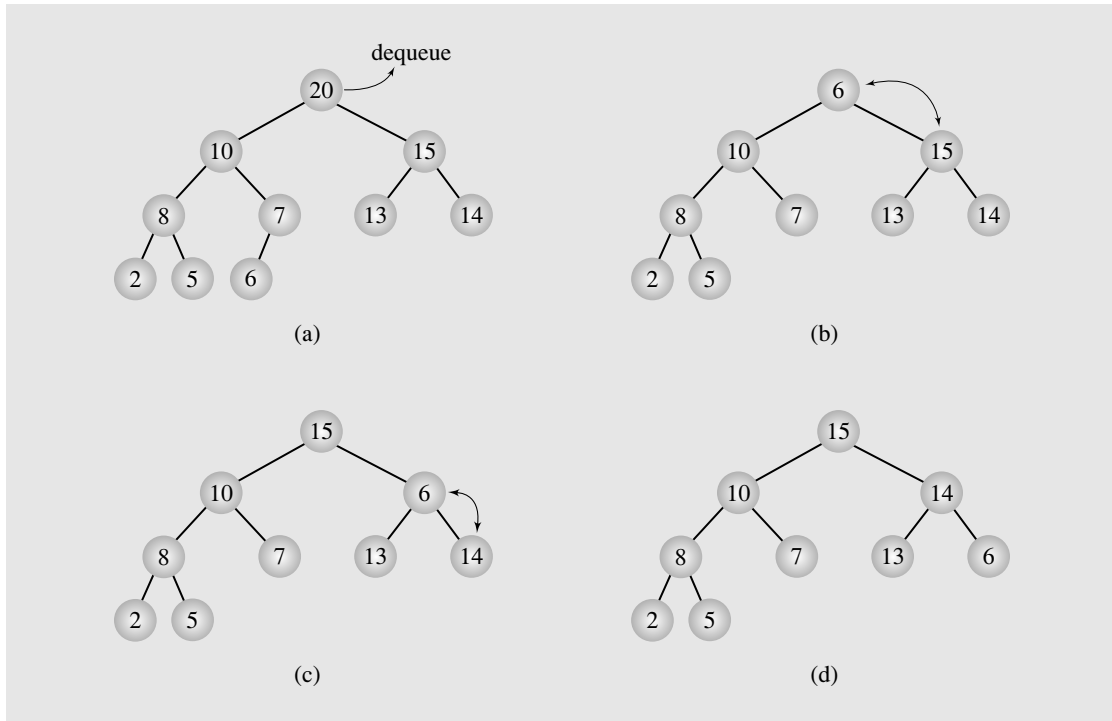
```

heapDequeue ( )
    extract the element from the root;
    put the element from the last leaf in its place;
    remove the last leaf;
    // both subtrees of the root are heaps;
    p = the root;
    while p is not a leaf and p < any of its children
        swap p with the larger child;
  
```

For example, 20 is dequeued from the heap in Figure 6.55a and 6 is put in its place (Figure 6.55b). To restore the heap property, 6 is swapped first with its larger child, number 15 (Figure 6.55c), and once again with the larger child, 14 (Figure 6.55d).

The last three lines of the dequeuing algorithm can be treated as a separate algorithm that restores the heap property only if it has been violated by the root of the tree. In this case, the root element is moved down the tree until it finds a proper position. This algorithm, which is the key to the heap sort, is presented in one possible implementation in Figure 6.56.



**FIGURE 6.55** Dequeuing an element from a heap.**FIGURE 6.56** Implementation of an algorithm to move the root element down a tree.

```

void moveDown(Object[] data, int first, int last) {
    int largest = 2*first + 1;
    while (largest <= last) {
        if (largest < last && // first has two children (at 2*first+1 and
                               // 2*first+2)
            ((Comparable)data[largest]).compareTo(data[largest+1]) < 0)
            largest++;
        if (((Comparable)data[first]).compareTo(data[largest]) < 0) {
            swap(data,first,largest); // if necessary, swap values
            first = largest; // and move down;
            largest = 2*first + 1;
        }
        else largest = last + 1; // to exit the loop: the heap property
    } // isn't violated by data[first]
}

```

## 6.9.2 Organizing Arrays as Heaps

Heaps can be implemented as arrays, and in that sense, each heap is an array, but all arrays are not heaps. In some situations, however, most notably in heap sort (see Section 9.3.2), we need to convert an array into a heap (that is, reorganize the data in the array so that the resulting organization represents a heap). There are several ways to do this, but in light of the preceding section the simplest way is to start with an empty heap and sequentially include elements into a growing heap. This is a top-down method and it was proposed by John Williams; it extends the heap by enqueueing new elements in the heap.

Figure 6.57 contains a complete example of the top-down method. First, the number 2 is enqueueed in the initially empty heap (6.57a). Next, 8 is enqueueed by putting it at the end of the current heap (6.57b) and then swapping with its parent (6.57c). Enqueueing the third and fourth elements, 6 (6.57d) and then 1 (6.57e), necessitates no swaps. Enqueueing the fifth element, 10, amounts to putting it at the end of the heap (6.57f), then swapping it with its parent, 2 (6.57g), and then with its new parent, 8 (6.57h) so that eventually 10 percolates up to the root of the heap. All remaining steps can be traced by the reader in Figure 6.57.

To check the complexity of the algorithm, observe that in the worst case, when a newly added element has to be moved up to the root of the tree,  $\lfloor \lg k \rfloor$  exchanges are made in a heap of  $k$  nodes. Therefore, if  $n$  elements are enqueueed, then in the worst case

$$\sum_{k=1}^n \lfloor \lg k \rfloor \leq \sum_{k=1}^n \lg k = \lg 1 + \cdots + \lg n = \lg(1 \cdot 2 \cdot \cdots \cdot n) = \lg(n!) = O(n \lg n)$$

exchanges are made during execution of the algorithm and the same number of comparisons. (For the fact that  $\lg(n!)$  is  $O(n \lg n)$ , see Section A.2 in Appendix A.) It turns out, however, that we can do better than that.

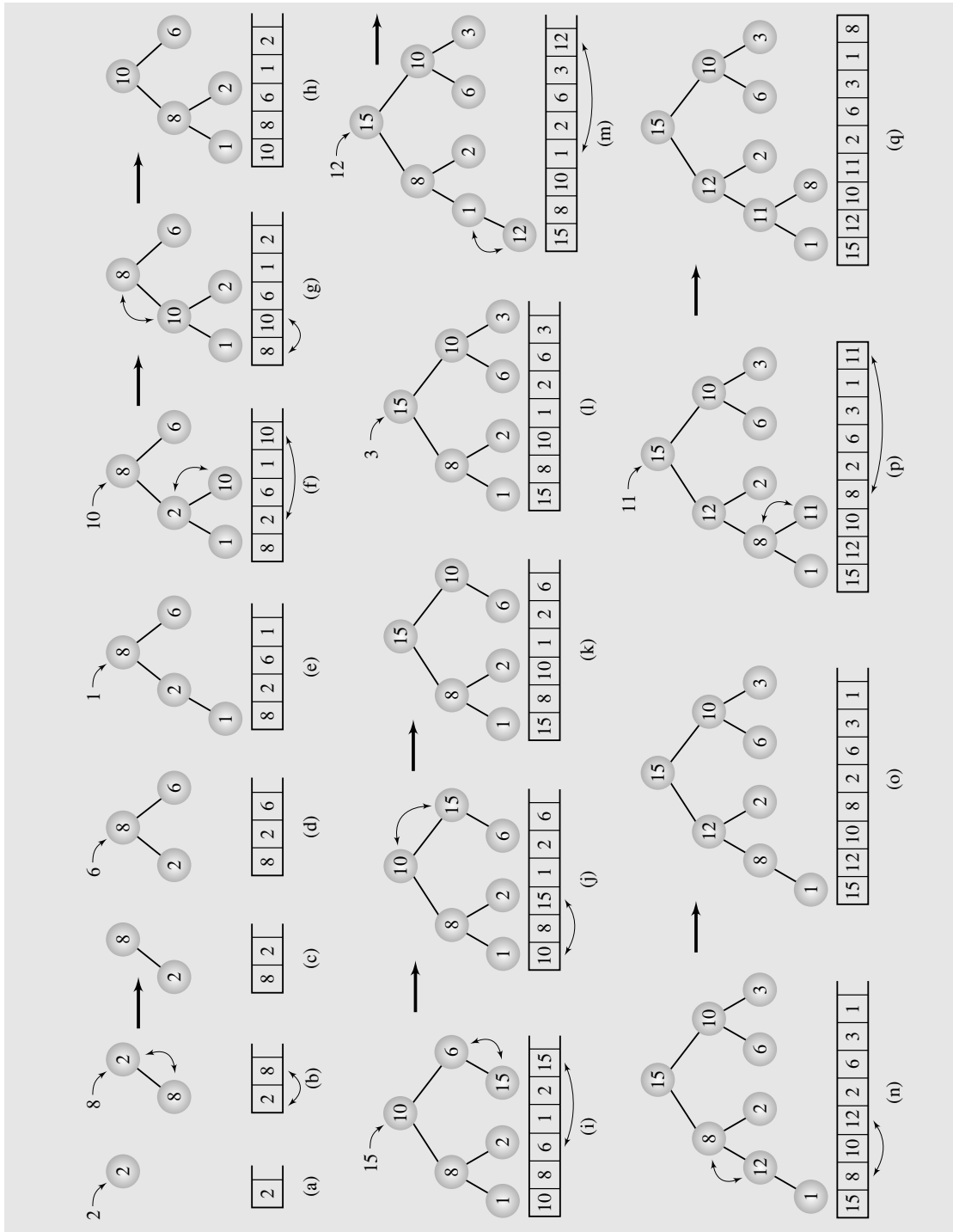
In another algorithm, developed by Robert Floyd, a heap is built bottom-up. In this approach, small heaps are formed and repetitively merged into larger heaps in the following way:

```
FloydAlgorithm(data[ ])
  for i = index of the last nonleaf down to 0
    restore the heap property for the tree whose root is data[i] by calling
      moveDown(data, i, n-1);
```

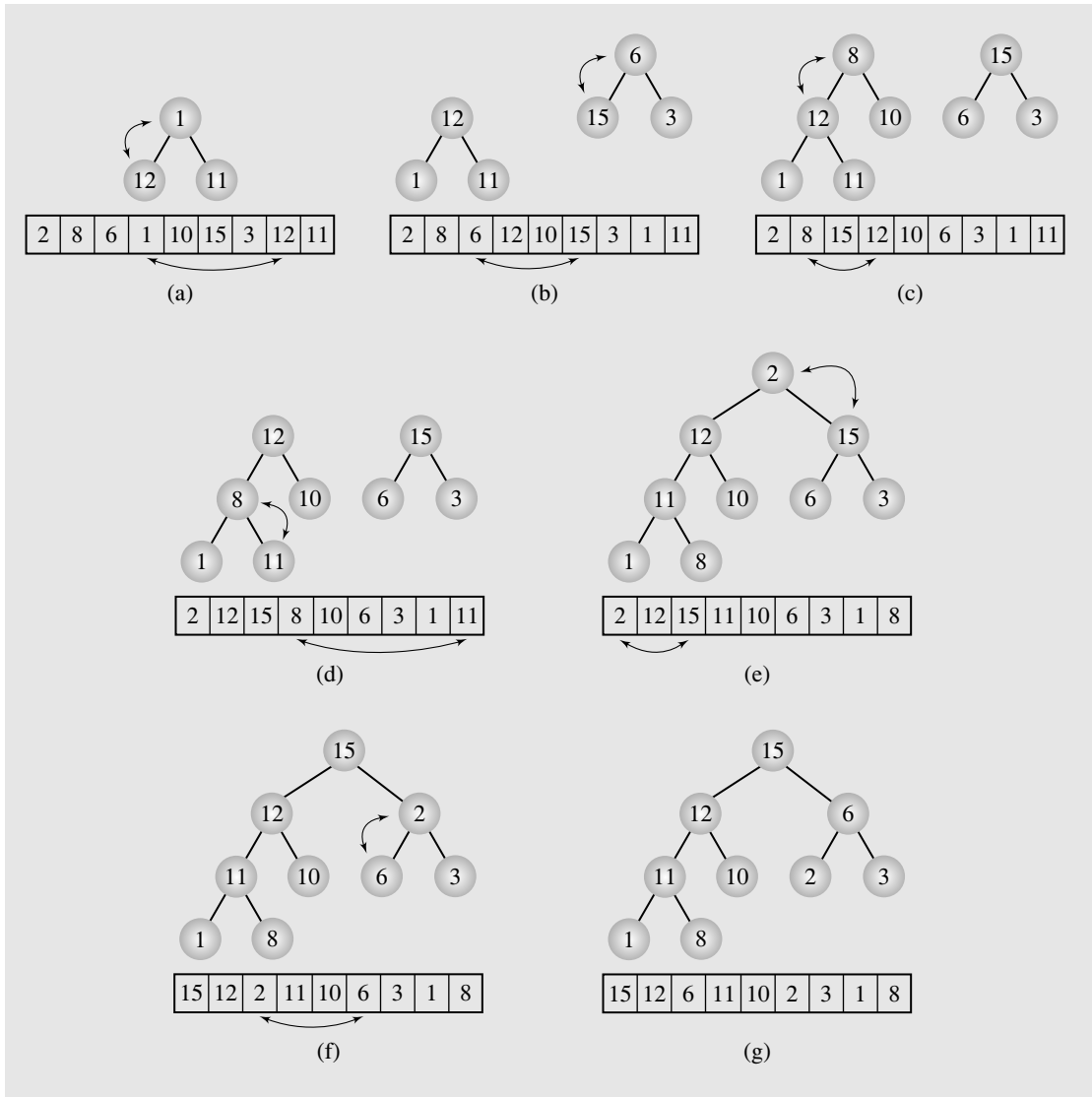
Figure 6.58 contains an example of transforming the array `data[ ] = [2 8 6 1 10 15 3 12 11]` into a heap.

We start from the last nonleaf node, which is `data[n/2-1]`,  $n$  being the array size. If `data[n/2-1]` is less than one of its children, it is swapped with the larger child. In the tree in Figure 6.58a, this is the case for `data[3] = 1` and `data[7] = 12`. After exchanging the elements, a new tree is created, shown in Figure 6.58b. Next the element `data[n/2-2] = data[2] = 6` is considered. Because it is smaller than its child `data[5] = 15`, it is swapped with that child and the tree is transformed to that in Figure 6.58c. Now `data[n/2-3] = data[1] = 8` is considered. Because it is smaller than one of its children, which is `data[3] = 12`, an interchange occurs, leading to the tree in Figure 6.58d. But now it can be noticed that the order established in the subtree whose root was 12 (Figure 6.58c) has been somewhat disturbed because 8

**FIGURE 6.57** Organizing an array as a heap with a top-down method.



**FIGURE 6.58** Transforming the array [2 8 6 1 10 15 3 12 11] into a heap with a bottom-up method.



is smaller than its new child 11. This simply means that it does not suffice to compare a node's value with its children's, but a similar comparison needs to be done with grandchildren's, great-grandchildren's, and so on until the node finds its proper position. Taking this into consideration, the next swap is made, after which the tree in Figure 6.58e is created. Only now is the element  $\text{data}[n/2-4] = \text{data}[0] = 2$  compared with its children, which leads to two swaps (Figure 6.58f).

Assume that the heap being created is a complete binary tree; that is, it includes  $n = 2^k - 1$  nodes for some  $k$ . To create the heap, `moveDown()` is called  $\frac{n+1}{2}$  times, once for each nonleaf. In the worst case, `moveDown()` moves data from the next to last level, consisting of  $\frac{n+1}{4}$  nodes, down by one level to the level of leaves by performing  $\frac{n+1}{4}$  swaps. Therefore, all nodes from this level make  $1 \cdot \frac{n+1}{4}$  moves. Data from the second to last level, which has  $\frac{n+1}{8}$  nodes, are moved two levels down to reach the level of the leaves. Thus, nodes from this level perform  $2 \cdot \frac{n+1}{8}$  moves and so on up to the root. The root of the tree as the tree becomes a heap is moved, again in the worst case,  $\lg(n+1) - 1 = \lg \frac{n+1}{2}$  levels down the tree to end up in one of the leaves. Because there is only one root, this contributes  $\lg \frac{n+1}{2} \cdot 1$  moves. The total number of movements can be given by this sum

$$\sum_{i=2}^{\lg(n+1)} \frac{n+1}{2^i} (i-1) = (n+1) \sum_{i=2}^{\lg(n+1)} \frac{i-1}{2^i}$$

which is  $O(n)$  because the series  $\sum_{i=2}^{\infty} \frac{i}{2^i}$  converges to 1.5 and  $\sum_{i=2}^{\infty} \frac{1}{2^i}$  converges to 0.5. For an array that is not a complete binary tree, the complexity is all the more bounded by  $O(n)$ . The worst case for comparisons is twice this value, which is also  $O(n)$ , because for each node in `moveDown()`, both children of the node are compared to each other to choose the larger. That, in turn, is compared to the node. Therefore, for the worst case, Williams's method performs better than Floyd's.

The performance for the average case is much more difficult to establish. It has been found that Floyd's heap construction algorithm requires, on average,  $1.88n$  comparisons (Doberkat 1984; Knuth 1998), and the number of comparisons required by Williams's algorithm in this case is between  $1.75n$  and  $2.76n$  and the number of swaps is  $1.3n$  (Hayward and McDiarmid 1991; McDiarmid and Reed 1989). Thus, in the average case, the two algorithms perform at the same level.

## 6.10

## POLISH NOTATION AND EXPRESSION TREES

One of the applications of binary trees is an unambiguous representation of arithmetical, relational, or logical expressions. In the early 1920s, a Polish logician, Jan Łukasiewicz (pronounced: wook-a-sie-vich), invented a special notation for propositional logic that allows us to eliminate all parentheses from formulas. However, Łukasiewicz's notation, called *Polish notation*, results in less readable formulas than the parenthesized originals and it was not widely used. It proved useful after the emergence of computers, however, especially for writing compilers and interpreters.

To maintain readability and prevent the ambiguity of formulas, extra symbols such as parentheses have to be used. However, if avoiding ambiguity is the only goal, then these symbols can be omitted at the cost of changing the order of symbols used in the formulas. This is exactly what the compiler does. It rejects everything that is not essential to retrieve the proper meaning of formulas, rejecting it as "syntactic sugar."

How does this notation work? Look first at the following example. What is the value of this algebraic expression?

$$2 - 3 \cdot 4 + 5$$

The result depends on the order in which the operations are performed. If we multiply first and then subtract and add, the result is  $-5$  as expected. If subtraction is done first, then addition and multiplication, as in

$$(2 - 3) \cdot (4 + 5)$$

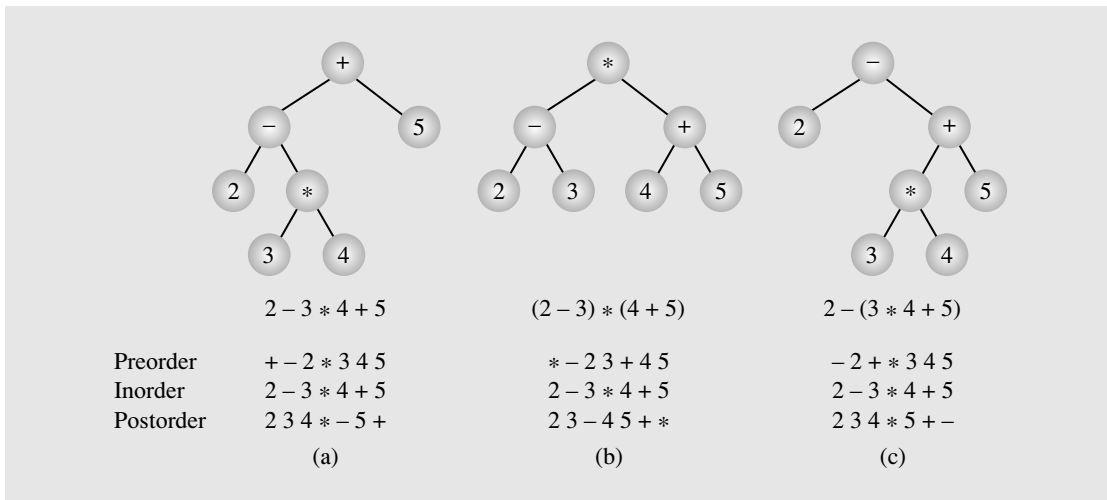
the result is  $-9$ . But if we subtract after we multiply and add, as in

$$2 - (3 \cdot 4 + 5)$$

then the result of evaluation is  $-15$ . If we see the first expression, then we know in what order to evaluate it. But the computer does not know that, in such a case, multiplication has precedence over addition and subtraction. If we want to override the precedence, then parentheses are needed.

Compilers need to generate assembly code in which one operation is executed at a time and the result is retained for other operations. Therefore, all expressions have to be broken down unambiguously into separate operations and put into their proper order. That is where Polish notation is useful. It allows us to create an *expression tree*, which imposes an order on the execution of operations. For example, the first expression,  $2 - 3 \cdot 4 + 5$ , which is the same as  $2 - (3 \cdot 4) + 5$ , is represented by the tree in Figure 6.59a. The second and the third expressions correspond to the trees in Figures 6.59b and 6.59c. It is obvious now that in both Figure 6.59a and Figure 6.59c we have to first multiply 3 by 4 to obtain 12. But 12 is subtracted from 2, according to the tree in Figure 6.59a, and added to 5, according to Figure 6.59c. There is no ambiguity involved in this tree representation. The final result can be computed only if intermediate results are calculated first.

**FIGURE 6.59** Examples of three expression trees and results of their traversals.



Notice also that trees do not use parentheses and yet no ambiguity arises. We can maintain this parentheses-free situation if the expression tree is linearized (that is, if the tree is transformed into an expression using a tree traversal method). The three traversal methods relevant in this context are preorder, inorder, and postorder tree traversals. Using these traversals, nine outputs are generated, as shown in Figure 6.59. Interestingly, inorder traversal of all three trees results in the same output, which is the initial expression that caused all the trouble. What it means is that inorder tree traversal is not suitable for generating unambiguous output. But the other two traversals are. They are different for different trees and are therefore useful for the purpose of creating unambiguous expressions and sentences.

Because of the importance of these different conventions, special terminology is used. Preorder traversal generates *prefix notation*, inorder traversal generates *infix notation*, and postorder traversal generates *postfix notation*. Note that we are accustomed to infix notation. In infix notation, an operator is surrounded by its two operands. In prefix notation, the operator precedes the operands, and in postfix notation, the operator follows the operands. Some programming languages are using Polish notation. For example, Forth and PostScript use postfix notation. LISP and, to a large degree, LOGO use prefix notation.

### 6.10.1 Operations on Expression Trees

Binary trees can be created in two different ways: top-down or bottom-up. In the implementation of insertion, the first approach was used. This section applies the second approach by creating expression trees bottom-up while scanning infix expressions from left to right.

The most important part of this construction process is retaining the same precedence of operations as in the expression being scanned, as exemplified in Figure 6.59. If parentheses are not allowed, the task is simple, as parentheses allow for many levels of nesting. Therefore, an algorithm should be powerful enough to process any number of nesting levels in an expression. A natural approach is a recursive implementation. We modify the recursive descent interpreter discussed in Chapter 5's case study and outline a recursive descent expression tree constructor.

As Figure 6.59 indicates, a node contains either an operator or an operand, the latter being either an identifier or a number. To simplify the task, all of them can be represented as strings in an instance of the class defined as

```
class ExprTreeNode {
    String key;
    ExprTreeNode left, right;
    ExprTreeNode(String k) {
        this(k,null,null);
    }
    ExprTreeNode(String k, ExprTreeNode pt1, ExprTreeNode pt2) {
        key = new String(k); left = pt1; right = pt2;
    }
    . . . . .
}
```

Expressions that are converted to trees use the same syntax as expressions in the case study in Chapter 5. Therefore, the same syntax diagrams can be used. Using these diagrams, a class `ExprTree` can be created in which methods for processing a factor and term have the following pseudocode (a method for processing an expression has the same structure as the method processing a term):

```
class ExprTree {
    protected ExprTreeNode root;
    ExprTreeNode factor() {
        if (token is a number, id or operator)
            return new ExprTreeNode(token);
        else if (token is '(') {
            ExprTreeNode p = expr();
            if (token is ')')
                return p;
            else error;
        }
    }
    ExprTreeNode term() {
        String oper;
        ExprTreeNode p1, p2;
        p1 = factor();
        while (token is '*' or '/') {
            oper = token;
            p2 = factor();
            p1 = new ExprTreeNode(oper, p1, p2);
        }
        return p1;
    }
    . . . . .
}
```

The tree structure of expressions is very suitable for generating assembly code or intermediate code in compilers, as shown in this pseudocode of a function from `ExprTree` class:

```
void generateCode() {
    generateCode(root);
}
String generateCode(ExprTreeNode p) {
    if (p.key is a number or id)
        return p.key;
    else if (p.key.charAt(0) == '+') {
        String result = newTemporaryVar();
        output "+\t" + generateCode(p.left) +
            "\t" + generateCode(p.right) + "\t" + result;
    }
}
```



```

        return result;
    }
    . . . . .
}

```

With these methods, an expression

$$(var2 + n) * (var2 + var1) / 5$$

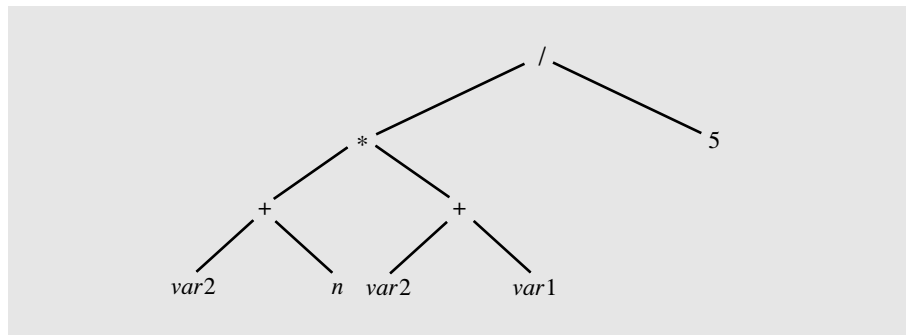
is transformed into an expression tree shown in Figure 6.60, and from this tree, `generateCode()` generates the following intermediate code:

```

add      var2      n      _tmp_3
add      var2      var1    _tmp_4
mul      _tmp_3    _tmp_4    _tmp_2
div      _tmp_2    5      _tmp_1

```

**FIGURE 6.60** An expression tree.

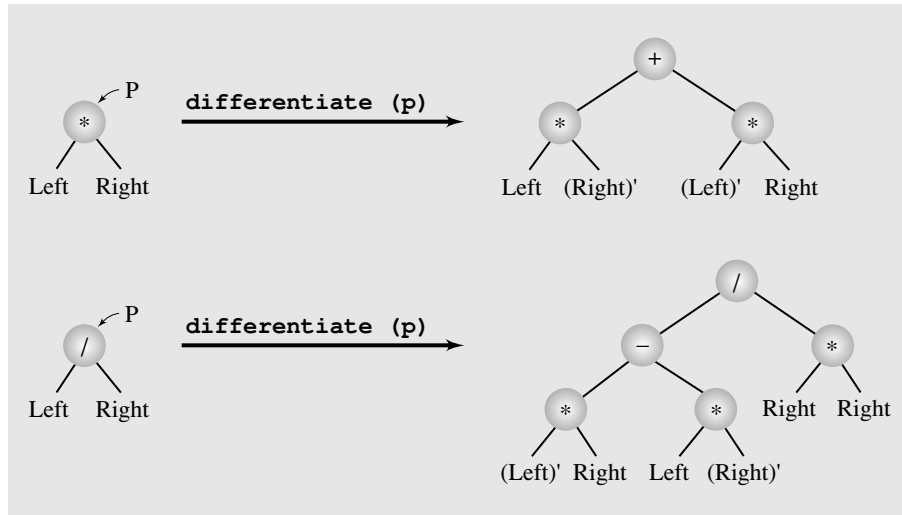


Expression trees are also very convenient for performing other symbolic operations, such as differentiation. Rules for differentiation (given in the programming assignments in Chapter 5) are shown in the form of tree transformations in Figure 6.61 and in the following pseudocode:

```

differentiate(p,x) {
    if (p == 0)
        return 0;
    if (p.key is the id x)
        return new ExprTreeNode("1");
    if (p.key is another id or a number)
        return new ExprTreeNode("0");
    if (p.key is '+' or '-')
        return new ExprTreeNode(p.key,differentiate(p.left,x),
                                differentiate(p.right,x));
    if (p.key is '*')
        ExprTreeNode *q = new ExprTreeNode("+");
        q.left = new ExprTreeNode("*",p.left,new ExprTreeNode(*p.right));
}

```

**FIGURE 6.61** Tree transformations for differentiation of multiplication and division.

```

q.left.right = differentiate(q.left.right,x);
q.right = new ExprTreeNode("*",new ExprTreeNode(*p.left),p.right);
q.right.left = differentiate(q.right.left,x);
return q;
. . . . .
}

```

Here  $p$  is a reference to the expression to be differentiated with respect to  $x$ .

The rule for division is left as an exercise.

## 6.11 CASE STUDY: COMPUTING WORD FREQUENCIES

One tool in establishing authorship of text in cases when the text is not signed, or it is attributed to someone else, is using word frequencies. If it is known that an author  $A$  wrote text  $T_1$  and the distribution of word frequencies in a text  $T_2$  under scrutiny is very close to the frequencies in  $T_1$ , then it is likely that  $T_2$  was written by author  $A$ .

Regardless of how reliable this method is for literary studies, our interest lies in writing a program that scans a text file and computes the frequency of the occurrence of words in this file. For the sake of simplification, punctuation marks are disregarded and case sensitivity is disabled. Therefore, the word *man's* is counted as two words, *man* and *s*, although in fact it may be one word (for possessive) and not two words (contraction for *man is* or *man has*). But contractions are counted separately; for example, *s* from *man's* is considered a separate word. Similarly, separators in the middle of words such as hyphens cause portions of the same words to be considered separate words. For example, *pre-existence* is split into *pre* and *existence*. Also, by disabling case

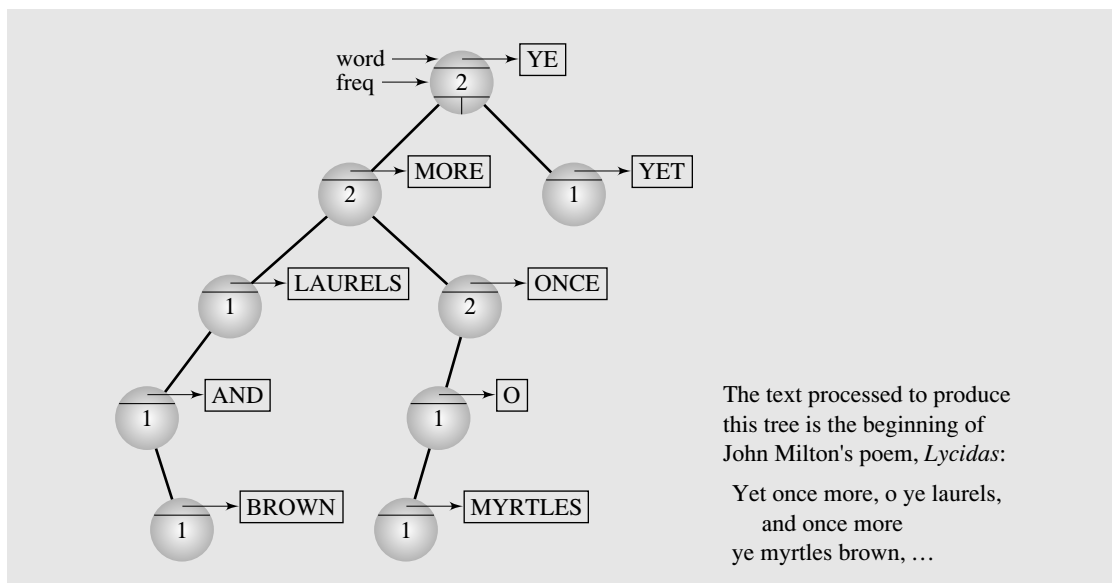
sensitivity, *Good* in the phrase *Mr. Good* is considered as another occurrence of the word *good*. On the other hand, *Good* used in its normal sense at the beginning of a sentence is properly included as another occurrence of *good*.

This program focuses not so much on linguistics as on building a self-adjusting binary search tree using the semisplaying technique. If a word is encountered in the file for the first time, it is inserted in the tree; otherwise, the semisplaying is started from the node corresponding to this word.

Another concern is storing all predecessors when scanning the tree. It is achieved by using a reference to the parent. In this way, from each node we can access any predecessor of this node up to the root of the tree.

Figure 6.62 shows the structure of the tree using the content of a short file, and Figure 6.63 contains the complete code. The program reads a word, which is any sequence of alphanumeric characters that starts with a letter (spaces, punctuation marks, and the like are discarded) and checks whether the word is in the tree. If so, the semisplaying technique is used to reorganize the tree and then the word's frequency count is incremented. Note that this movement toward the root is accomplished by changing links of the nodes involved, not by physically transferring information from one node to its parent and then to its grandparent and so on. If a word is not found in the tree, it is inserted in the tree by creating a new leaf for it. After all words are processed, an inorder tree traversal goes through the tree to count all the nodes and add all frequency counts to print as the final result the number of words in the tree and the number of words in the file.

**FIGURE 6.62** Semisplay tree used for computing word frequencies.



**FIGURE 6.63** Implementation of word frequency computation.

```

/***** BSTNode.java *****/
*
*       node of a generic binary search tree
*/

public class BSTNode {
    protected Comparable el;
    protected BSTNode left, right;
    public BSTNode() {
        left = right = null;
    }
    public BSTNode(Comparable el) {
        this(el,null,null);
    }
    public BSTNode(Comparable el, BSTNode lt, BSTNode rt) {
        this.el = el; left = lt; right = rt;
    }
}

/***** BST.java *****/
*
*       generic binary search tree
*/

public class BST {
    protected BSTNode root = null;
    public BST() {
    }
    public Comparable search(Comparable el) {
        return search(root,el);
    }
    protected Comparable search(BSTNode p, Comparable el) {
        while (p != null)
            if (el.equals(p.el))
                return p.el;
            else if (el.compareTo(p.el) < 0)
                p = p.left;
            else p = p.right;
        return null;
    }
    public void insert(Comparable el) {
        BSTNode p = root, prev = null;
        while (p != null) { // find a place for inserting new node;
            prev = p;

```

**FIGURE 6.63** (continued)

```

        if (p.el.compareTo(el) < 0)
            p = p.right;
        else p = p.left;
    }
    if (root == null)    // tree is empty;
        root = new BSTNode(el);
    else if (prev.el.compareTo(el) < 0)
        prev.right = new BSTNode(el);
    else prev.left = new BSTNode(el);
}
protected void visit(BSTNode p) {
    System.out.print(p.el + " ");
}
public void inorder() {
    inorder(root);
}
protected void inorder(BSTNode p) {
    if (p != null) {
        inorder(p.left);
        visit(p);
        inorder(p.right);
    }
}
.....
}

/***** SplayTreeNode.java *****/
*           node for generic splaying tree class
*/

public class SplayTreeNode extends BSTNode {
    protected BSTNode parent;
    public SplayTreeNode() {
        left = right = parent = null;
    }
    public SplayTreeNode(Comparable el) {
        this(el,null,null,null);
    }
    public SplayTreeNode(Comparable ob, SplayTreeNode lt,
                        SplayTreeNode rt, SplayTreeNode pr) {
        el = ob; left = lt; right = rt; parent = pr;
    }
}

```

*Continues*

**FIGURE 6.63** (continued)

```

/***** SplayTree.java *****/
*          generic splaying tree class
*/

public class SplayTree extends BST {
    public SplayTree() {
        super();
    }
    private void continueRotation(BSTNode gr, BSTNode par,
                                  BSTNode ch, BSTNode desc) {
        if (gr != null) { // if par has a grandparent;
            if (gr.right == ((SplayTreeNode)ch).parent)
                gr.right = ch;
            else gr.left = ch;
        }
        else root = ch;
        if (desc != null)
            ((SplayTreeNode)desc).parent = par;
        ((SplayTreeNode)par).parent = ch;
        ((SplayTreeNode)ch).parent = gr;
    }
    private void rotateR(SplayTreeNode p) {
        p.parent.left = p.right;
        p.right = p.parent;
        continueRotation(((SplayTreeNode)p.parent).parent,
                          p.right,p,p.right.left);
    }
    private void rotateL(SplayTreeNode p) {
        p.parent.right = p.left;
        p.left = p.parent;
        continueRotation(((SplayTreeNode)p.parent).parent,
                          p.left,p,p.left.right);
    }
    private void semisplay(SplayTreeNode p) {
        while (p != root) {
            if (((SplayTreeNode)p.parent).parent == null) // if p's
                parent is
                if (p.parent.left == p) // the root;
                    rotateR(p);
                else rotateL(p);
            else if (p.parent.left == p) // if p is a left child;
                if (((SplayTreeNode)p.parent).parent.left == p.parent) {

```

**FIGURE 6.63** (continued)

```

        rotateR((SplayTreeNode)p.parent);
        p = (SplayTreeNode)p.parent;
    }
    else {
        rotateR((SplayTreeNode)p); // rotate p and its
        parent;
        rotateL((SplayTreeNode)p); // rotate p and its new
        parent;
    }
    else // if p is a right child;
    if (((SplayTreeNode)p.parent).parent.right == p.parent) {
        rotateL((SplayTreeNode)p.parent);
        p = (SplayTreeNode)p.parent;
    }
    else {
        rotateL(p); // rotate p and its parent;
        rotateR(p); // rotate p and its new
        // parent;
    }
    if (root == null) // update the root;
        root = p;
    }
}
}

/***** WordSplaying.java *****/

import java.io.*;

class Word implements Comparable {
    private String word = "";
    public int freq = 1;
    public Word() {
    }
    public Word(String s) {
        word = s;
    }
    public boolean equals(Object el) {
        return word.equals(((Word)el).word);
    }
    public int compareTo(Object el) {
        return word.compareTo(((Word)el).word);
    }
}

```

*Continues*

**FIGURE 6.63** (continued)

```

    }
    public String toString() {
        return word + ": " + freq + " ";
    }
}

class WordSplay extends SplayTree {
    private int differentWords, // counter of different words in text
        // file;
        wordCnt; // counter of all words in the same file;
    public WordSplay() {
        differentWords = wordCnt = 0;
    }
    protected void visit(BSTNode p) {
        differentWords++;
        wordCnt += ((Word)p.el).freq;
    }
    public void run(InputStream fIn, String fileName) {
        int ch = 1;
        Word p;
        try {
            while (ch > -1) {
                while (true)
                    if (ch > -1 && !Character.isLetter((char)ch)) // skip
                        ch = fIn.read(); // nonletters;
                    else break;
                if (ch == -1)
                    break;
                String s = "";
                while (ch > -1 && Character.isLetter((char)ch)) {
                    s += Character.toUpperCase((char)ch);
                    ch = fIn.read();
                }
                if ((p = (Word)search(new Word(s))) == null)
                    insert(new Word(s));
                else ((Word)p).freq++;
            }
        } catch (IOException io) {
            System.err.println("A problem with input");
        }
        inorder();
        System.out.println("\n\nFile " + fileName

```



**FIGURE 6.63** (continued)

```

        + " contains " + wordCnt + " words among which "
        + differentWords + " are different\n");
    }
}

class WordSplaying {
    static public void main(String args[]) {
        String fileName = "";
        InputStream fIn;
        BufferedReader buffer = new BufferedReader(
            new InputStreamReader(System.in));
        try {
            if (args.length == 0) {
                System.out.print("Enter a file name: ");
                fileName = buffer.readLine();
                fIn = new FileInputStream(fileName);
            }
            else {
                fIn = new FileInputStream(args[0]);
                fileName = args[0];
            }
            (new WordSplay()).run(fIn, fileName);
            fIn.close();
        } catch (IOException io) {
            System.err.println("Cannot open " + fileName);
        }
    }
}

```

This program also illustrates the use of a generic binary search tree. Because scanning this tree requires using comparison and the meaning of comparison varies from one data type to another, when defining a tree, the comparison has to be used in a generic way, and only when creating a specific tree is the generic comparison overridden by a definition pertaining to the data type for which the tree was created. This is accomplished by declaring the element inserted in a generic tree to be of type `Comparable`; therefore, a generic tree node `BSTNode` is defined in terms of

`Comparable`, and only then a generic binary search tree class `BST` is defined using `BSTNode`. Only now are the methods in the `BST` class defined with a generic `compareTo()` method from `Comparable`. Figure 6.63 shows `search()` and `insert()` methods, both using `compareTo()`. Next, a generic `SplayTree` class is defined as an extension of `BST`, and then a specific splaying tree, `WordTree`, is defined in terms of the `Word` class that holds information relevant to the problem of finding word frequencies. Because `Comparable` is an interface, the `Word` class for objects to be inserted into a splay tree must be defined as a class implementing `Comparable`, and the definition of the class must include a definition of the `compareTo()` method. The `Word` class also includes definitions of methods that override generic definitions provided in the `Object` class, namely the `equals()` and `toString()` methods.

## 6.12 EXERCISES

1. The method `search()` given in Section 6.3 is well suited for searching *binary search* trees. Try to adopt all four traversal algorithms so that they become search procedures for any binary tree.
2. Write functions
  - a. to count the number of nodes in a binary tree
  - b. to count the number of leaves
  - c. to count the number of right children
  - d. to find the height of the tree
  - e. to delete all leaves from a binary tree
3. Write a method that checks whether a binary tree is perfectly balanced.
4. Design an algorithm to test whether a binary tree is a binary search tree.
5. Apply `preorder()`, `inorder()`, and `postorder()` to the tree in Figure 6.64 if `visit(p)` in `IntBSTNode` is defined as:
  - a. 

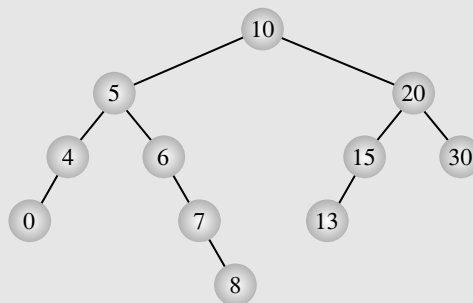
```
if (p.left != null && p.key - p.left.key < 2)
    p.left.key += 2;
```
  - b. 

```
if (p.left == null)
    p.right = null;
```
  - c. 

```
if (p.left == null)
    p.left = new IntBSTNode(p.key-1);
```
  - d. 

```
{ IntBSTNode tmp = p.right;
  p.right = p.left;
  p.left = tmp;
}
```
6. For which trees do the preorder and inorder traversals generate the same sequence?

**FIGURE 6.64** An example of a binary search tree.

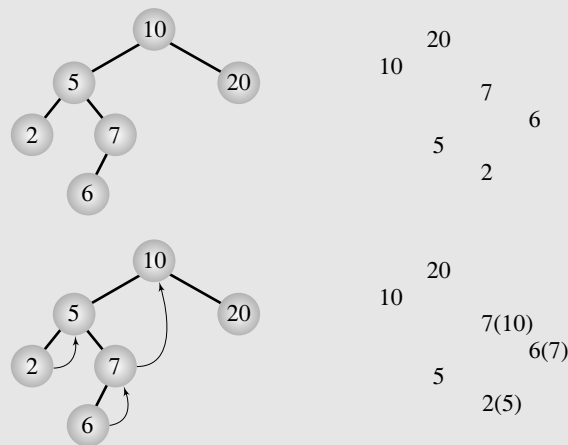


7. Figure 6.59 indicates that the inorder traversal for different trees can result in the same sequence. Is this possible for the preorder or postorder traversals? If it is, show an example.
8. Draw all possible binary search trees for the three elements *A*, *B*, and *C*.
9. What are the minimum and maximum numbers of leaves in a balanced tree of height *h*?
10. Write a method to create a mirror image of a binary tree.
11. Consider an operation *R* that for a given traversal method *t* processes nodes in the opposite order than *t*, and an operation *C* that processes nodes of the mirror image of a given tree using traversal method *t*. For the tree traversal methods—preorder, inorder, and postorder—determine which of the following nine equalities are true:

- $R(\text{preorder}) = C(\text{preorder})$
- $R(\text{preorder}) = C(\text{inorder})$
- $R(\text{preorder}) = C(\text{postorder})$
- $R(\text{inorder}) = C(\text{preorder})$
- $R(\text{inorder}) = C(\text{inorder})$
- $R(\text{inorder}) = C(\text{postorder})$
- $R(\text{postorder}) = C(\text{preorder})$
- $R(\text{postorder}) = C(\text{inorder})$
- $R(\text{postorder}) = C(\text{postorder})$

12. Using inorder, preorder, and postorder tree traversal, visit only leaves of a tree. What can you observe? How can you explain this phenomenon?
13. (a) Write a method that prints each binary tree rotated to the left with proper indentation, as in Figure 6.65a. (b) Adopt this method to print a threaded tree sideways; if appropriate, print the key in the successor node, as in Figure 6.65b.

**FIGURE 6.65** Printing a binary search tree (a) and a threaded tree (b) growing from left to right.





24. What is the number of comparisons and swaps in the best case for creating a heap using
- Williams's method?
  - Floyd's method?
25. A crossover between Floyd's and Williams's methods for constructing a heap is a method in which an empty position occupied by an element is moved down to the bottom of the tree and then the element is moved up the tree, as in Williams's method, from the position that was just moved down. A pseudocode of this function is as follows:

```

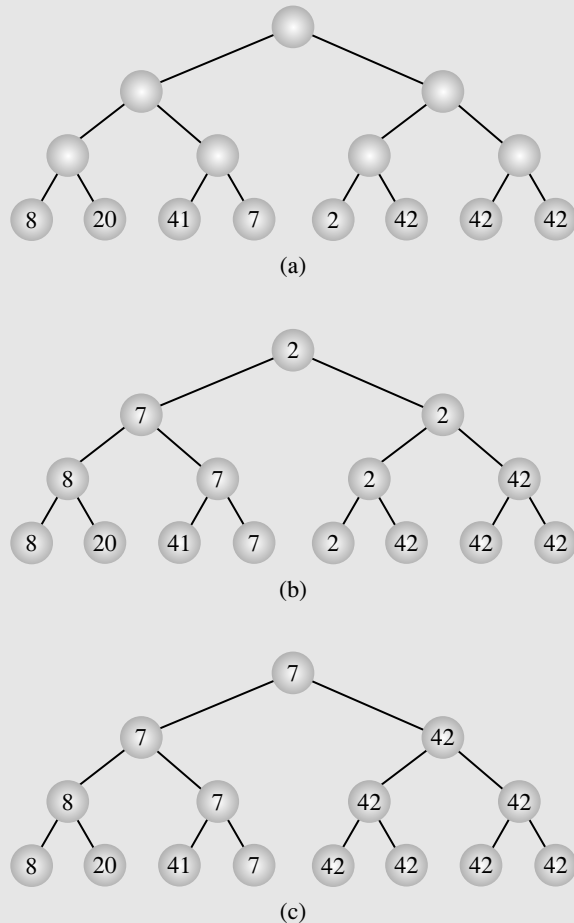
i = n/2-1; // position of the last parent in the array of n elements;
while (i >= 0)
    // Floyd's phase:
    tmp = data[i];
    consider element data[i] empty and move it down to the bottom
        swapping it every time with larger child;
    put tmp in the leaf at which this process ended;
    // Williams's phase: data[i] of the current tree
    while tmp is not the root data [i] of the current tree and it is larger
        than its parent swap tmp with its parent;
    i--; // go to the preceding parent;

```

It has been shown that this algorithm requires  $1.65n$  comparisons in the average case (McDiarmid and Reed, 1989). Show changes in the array [2 8 6 1 10 15 3 12 11] during execution of the algorithm. What is the worst case?

## 6.13 PROGRAMMING ASSIGNMENTS

- Write a program that accepts an arithmetic expression written in prefix (Polish) notation, builds an expression tree, and then traverses the tree to evaluate the expression. The evaluation should start after a complete expression has been entered.
- A binary tree can be used to sort  $n$  elements of an array `data`. First, create a complete binary tree, a tree with all leaves at one level, whose height  $h = \lceil \lg n \rceil + 1$ , and store all elements of the array in the first  $n$  leaves. In each empty leaf, store an element  $E$  greater than any element in the array. Figure 6.67a shows an example for `data = {8, 20, 41, 7, 2}`,  $h = \lceil \lg(5) \rceil + 1 = 4$ , and  $E = 42$ . Then, starting from the bottom of the tree, assign to each node the minimum of its two children values, as in Figure 6.67b, so that the smallest element  $e_{\min}$  in the tree is assigned to the root. Next, until the element  $E$  is assigned to the root, execute a loop that in each iteration stores  $E$  in the leaf, with the value of  $e_{\min}$ , and that, also starting from the bottom, assigns to each node the minimum of its two children. Figure 6.67c displays this tree after one iteration of the loop.
- Implement a menu-driven program for managing a software store. All information about the available software is stored in a file `software`. This information includes the name, version, quantity, and price of each package. When it is invoked, the program automatically creates a binary search tree with one node corresponding to one

**FIGURE 6.67** Binary tree used for sorting.

software package and includes as its key the name of the package and its version. Another field in this node should include the position of the record in the file `software`. The only access to the information stored in `software` should be through this tree.

The program should allow the file and tree to be updated when new software packages arrive at the store and when some packages are sold. The tree is updated in the usual way. All packages are entry ordered in the file `software`; if a new package arrives, then it is put at the end of the file. If the package already has an entry in the tree (and the file), then only the quantity field is updated. If a package is sold out, the corresponding node is deleted from the tree, and the quantity field in the file is changed to 0. For example, if the file has these entries:

Adobe Photoshop	7.0	21	580
Norton Utilities		10	30
Norton SystemWorks 2003		6	50
Visual J++ Professional	6.0	19	100
Visual J++ Standard	6.0	27	40

then after selling all six copies of Norton SystemWorks 2003, the file is

Adobe Photoshop	7.0	21	580
Norton Utilities		10	30
Norton SystemWorks 2003		0	50
Visual J++ Professional	6.0	19	100
Visual J++ Standard	6.0	27	40

If an exit option is chosen from the menu, the program cleans up the file by moving entries from the end of the file to the positions marked with 0 quantities. For example, the previous file becomes

Adobe Photoshop	7.0	21	580
Norton Utilities		10	45
Visual J++ Standard	6.0	19	40
Visual J++ Professional	6.0	27	100

4. Implement algorithms for constructing expression trees and for differentiating the expressions they represent. Extend the program to simplify expression trees. For example, two nodes can be eliminated from the subtrees representing  $a \pm 0$ ,  $a \cdot 1$ , or  $\frac{a}{1}$ .
5. Write a cross-reference program that constructs a binary search tree with all words included from a text file and records the line numbers on which these words were used. These line numbers should be stored on linked lists associated with the nodes of the tree. After the input file has been processed, print in alphabetical order all words of the text file along with the corresponding list of numbers of the lines in which the words occur.
6. Perform an experiment with alternately applying insertion and deletion of random elements in a randomly created binary search tree. Apply asymmetric and symmetric deletions (discussed in this chapter); for both these variants of the deletion algorithm, alternate deletions strictly with insertions and alternate these operations randomly. This gives four different combinations. Also, use two different random number generators to ensure randomness. This leads to eight combinations. Run all of these combinations for trees of heights 500, 1,000, 1,500, and 2,000. Plot the results and compare them with the expected IPLs indicated in this chapter.
7. Each unit in a Latin textbook contains a Latin-English vocabulary of words that have been used for the first time in a particular unit. Write a program that converts a set of such vocabularies stored in file `Latin` into a set of English-Latin vocabularies. Make the following assumptions:
  - a. Unit names are preceded by a percentage symbol.
  - b. There is only one entry per line.
  - c. A Latin word is separated by a colon from its English equivalent(s); if there is more than one equivalent, they are separated by a comma.



To output English words in alphabetical order, create a binary search tree for each unit containing English words and linked lists of Latin equivalents. Make sure that there is only one node for each English word in the tree. For example, there is only one node for *and*, although *and* is used twice in unit 6: with words *ac* and *atque*. After the task has been completed for a given unit (that is, the content of the tree has been stored in an output file), delete the tree along with all linked lists from computer memory before creating a tree for the next unit.

Here is an example of a file containing Latin-English vocabularies:

```
%Unit 5
ante : before, in front of, previously
antiquus : ancient
ardeo : burn, be on fire, desire
arma : arms, weapons
aurum : gold
aureus : golden, of gold
```

```
%Unit 6
animal : animal
Athenae : Athens
atque : and
ac : and
aurora : dawn
```

```
%Unit 7
amo : love
amor : love
annus : year
Asia : Asia
```

From these units, the program should generate the following output:

```
%Unit 5
ancient : antiquus
arms : arma
be on fire : ardeo
before : ante
burn : ardeo
desire : ardeo
gold: aurum
golden : aureus
in front of : ante
of gold : aureus
previously : ante
weapons : arma
```

```
%Unit 6
Athens : Athenae
and : ac, atque
animal : animal
dawn : aurora
```

```
%Unit 7
Asia : Asia
love : amor, amo
year : annus
```

8. Write a program to draw a binary search tree of numbers. The distance between levels should depend on the height of the tree (use a function from exercise 2). The distance between nodes on one level is the same and is twice the distance between nodes on the level above. To determine which link should be drawn, use a version of the breadth-first traversal that for each dequeued node  $p$  that does not correspond to the last level enqueues its left and right children if  $p$  is not null and two null nodes otherwise. Also, if  $p$  is not null, draw a line between  $p$  and its parent (unless  $p$  is the root), and draw no line if  $p$  is null. The total number of nodes to be processed depends on the height of the tree and equals  $2^h - 1$  (see Figure 6.35).

## BIBLIOGRAPHY

### *Insertions and Deletions*

Culberson, Joseph, "The Effect of Updates in Binary Search Trees," *Proceedings of the 17th Annual Symposium on Theory of Computing* (1985), 205–212.

Eppinger, Jeffrey L., "An Empirical Study of Insertion and Deletion in Binary Search Trees," *Communications of the ACM* 26 (1983), 663–669.

Hibbard, Thomas N., "Some Combinatorial Properties of Certain Trees with Applications to Searching and Sorting," *Journal of the ACM* 9 (1962), 13–28.

Jonassen, Arne T., and Knuth, Donald E., "A Trivial Algorithm Whose Analysis Isn't," *Journal of Computer and System Sciences* 16 (1978), 301–322.

Knuth, Donald E., "Deletions That Preserve Randomness," *IEEE Transactions of Software Engineering*, SE-3 (1977), 351–359.

### *Tree Traversals*

Bertziss, Alfs, "A Taxonomy of Binary Tree Traversals," *BIT* 26 (1986), 266–276.

Burkhard, W. A., "Nonrecursive Tree Traversal Algorithms," *Computer Journal* 18 (1975), 227–230.

Morris, Joseph M., "Traversing Binary Trees Simply and Cheaply," *Information Processing Letters* 9 (1979), 197–200.

**Balancing Trees**

Baer, J. L., and Schwab, B., "A Comparison of Tree-Balancing Algorithms," *Communications of the ACM* 20 (1977), 322–330.

Chang, Hsi, and Iyengar, S. Sitharama, "Efficient Algorithms to Globally Balance a Binary Search Tree," *Communications of the ACM* 27 (1984), 695–702.

Day, A. Colin, "Balancing a Binary Tree," *Computer Journal* 19 (1976), 360–361.

Martin, W. A., and Ness, D. N., "Optimizing Binary Trees Grown with a Sorting Algorithm," *Communications of the ACM* 1 (1972), 88–93.

Stout, Quentin F., and Warren, Bette L., "Tree Rebalancing in Optimal Time and Space," *Communications of the ACM* 29 (1986), 902–908.

**AVL Trees**

Adel'son-Vel'skii, G. M., and Landis, E. M., "An Algorithm for the Organization of Information," *Soviet Mathematics* 3 (1962), 1259–1263.

Foster, Caxton C., "A Generalization of AVL Trees," *Communications of the ACM* 16 (1973), 512–517.

Karlton, P. L., Fuller, S. H., Scroggs, R. E., and Kaehler, E. B., "Performance of Height-Balanced Trees," *Communications of the ACM* 19 (1976), 23–28.

Knuth, Donald, *The Art of Computer Programming, Vol. 3: Sorting and Searching*, Reading, MA: Addison-Wesley, 1998.

Zweben, S. H., and McDonald, M. A., "An Optimal Method for Deletion in One-Sided Height Balanced Trees," *Communications of the ACM* 21 (1978), 441–445.

**Self-Adjusting Trees**

Allen, Brian, and Munro, Ian, "Self-Organizing Binary Search Trees," *Journal of the ACM* 25 (1978), 526–535.

Bell, Jim, and Gupta, Gopal, "An Evaluation of Self-Adjusting Binary Search Tree Techniques," *Software—Practice and Experience* 23 (1993), 369–382.

Bitner, James R., "Heuristics That Dynamically Organize Data Structures," *SIAM Journal on Computing* 8 (1979), 82–110.

Sleator, Daniel D., and Tarjan, Robert E., "Self-Adjusting Binary Search Trees," *Journal of the ACM* 32 (1985), 652–686.

**Heaps**

Bollobés, B., and Simon, I., "Repeated Random Insertion into a Priority Queue Structure," *Journal of Algorithms* 6 (1985), 466–477.

Doberkat, E. E., "An Average Case of Floyd's Algorithm to Construct Heaps," *Information and Control* 61 (1984), 114–131.

- Floyd, Robert W., “Algorithm 245: Treesort 3,” *Communications of the ACM* 7 (1964), 701.
- Frieze, A., “On the Random Construction of Heaps,” *Information Processing Letters* 27 (1988), 103.
- Gonnet, Gaston H., and Munro, Ian, “Heaps on Heaps,” *SIAM Journal on Computing* 15 (1986), 964–971.
- Hayward, Ryan, and McDiarmid, Colin, “Average Case Analysis of Heap Building by Repeated Insertion,” *Journal of Algorithms* 12 (1991), 126–153.
- McDiarmid, C. J. H., and Reed, B. A., “Building Heaps Fast,” *Journal of Algorithms* 10 (1989), 351–365.
- Weiss, Mark A., *Data Structures and Algorithm Analysis*, Redwood City, CA: Benjamin Cummings, 1992, Ch. 6.
- Williams, J. W. J., “Algorithm 232: Heapsort,” *Communications of the ACM* 7 (1964), 347–348.

# Multiway Trees

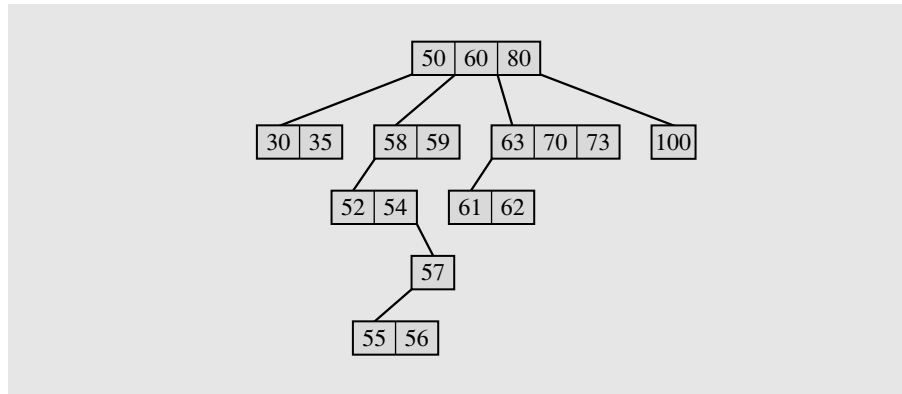


At the beginning of the preceding chapter, a general definition of a tree was given, but the thrust of that chapter was binary trees, in particular, binary search trees. A tree was defined as either an empty structure or a structure whose children are disjoint trees  $t_1, \dots, t_m$ . According to this definition, each node of this kind of tree can have more than two children. This tree is called a *multiway tree of order  $m$* , or an  *$m$ -way tree*.

In a more useful version of a multiway tree, an order is imposed on the keys residing in each node. A *multiway search tree of order  $m$* , or an  *$m$ -way search tree*, is a multiway tree in which

1. Each node has  $m$  children and  $m - 1$  keys.
2. The keys in each node are in ascending order.
3. The keys in the first  $i$  children are smaller than the  $i$ th key.
4. The keys in the last  $m - i$  children are larger than the  $i$ th key.

The  $m$ -way search trees play the same role among  $m$ -way trees that binary search trees play among binary trees, and they are used for the same purpose: fast information retrieval and update. The problems they cause are similar. The tree in Figure 7.1 is a 4-way tree in which accessing the keys can require a different number of tests for different keys: The number 35 can be found in the second node tested, and 55 is in the fifth node checked. The tree, therefore, suffers from a known malaise: It is unbalanced. This problem is of particular importance if we want to use trees to process data on secondary storage such as disks or tapes where each access is costly. Constructing such trees requires a more careful approach.

**FIGURE 7.1** A 4-way tree.

## 7.1 THE FAMILY OF B-TREES

The basic unit of I/O operations associated with a disk is a block. When information is read from a disk, the entire block containing this information is read into memory, and when information is stored on a disk, an entire block is written to the disk. Each time information is requested from a disk, this information has to be located on the disk, the head has to be positioned above the part of the disk where the information resides, and the disk has to be spun so that the entire block passes underneath the head to be transferred to memory. This means that there are several time components for data access:

$$\text{access time} = \text{seek time} + \text{rotational delay (latency)} + \text{transfer time}$$

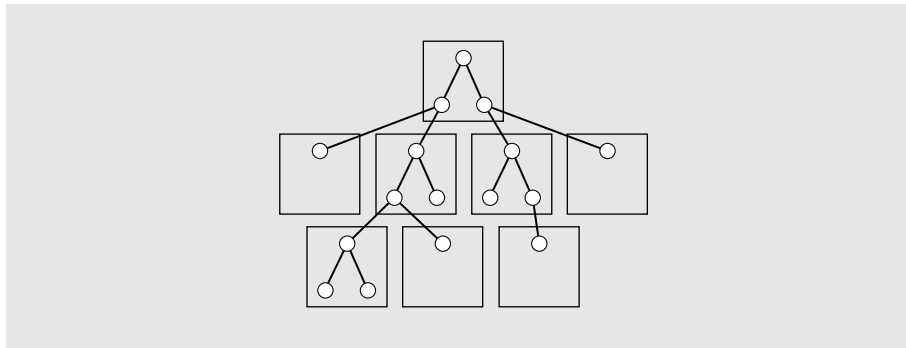
This process is extremely slow compared to transferring information within memory. The first component, *seek time*, is particularly slow because it depends on the mechanical movement of the disk head to position the head at the correct track of the disk. *Latency* is the time required to position the head above the correct block, and on the average, it is equal to the time needed to make one-half of a revolution. For example, the time needed to transfer 5KB (kilobytes) from a disk requiring 40 ms (milliseconds) to locate a track, making 3,000 revolutions per minute and with a data transfer rate of 1,000KB per second, is

$$\text{access time} = 40 \text{ ms} + 10 \text{ ms} + 5 \text{ ms} = 55 \text{ ms}$$

This example indicates that transferring information to and from the disk is on the order of milliseconds. On the other hand, the CPU processes data on the order of microseconds, 1,000 times faster, or on the order of nanoseconds, 1 million times faster, or even faster. We can see that processing information on secondary storage can significantly decrease the speed of a program.

If a program constantly uses information stored in secondary storage, the characteristics of this storage have to be taken into account when designing the program. For example, a binary search tree can be spread over many different blocks on a disk, as in Figure 7.2, so that an average of two blocks have to be accessed. When the tree is used frequently in a program, these accesses can significantly slow down the execution time of the program. Also, inserting and deleting keys in this tree require many block accesses. The binary search tree, which is such an efficient tool when it resides entirely in memory, turns out to be an encumbrance. In the context of secondary storage, its otherwise good performance counts very little because the constant accessing of disk blocks that this method causes severely hampers this performance.

**FIGURE 7.2** Nodes of a binary tree can be located in different blocks on a disk.



It is also better to access a large amount of data at one time than to jump from one position on the disk to another to transfer small portions of data. For example, if 10KB have to be transferred, then using the characteristics of the disk given earlier, we see that

$$\text{access time} = 40 \text{ ms} + 10 \text{ ms} + 10 \text{ ms} = 60 \text{ ms}$$

However, if this information is stored in two 5KB pieces, then

$$\text{access time} = 2 \cdot (40 \text{ ms} + 10 \text{ ms} + 5 \text{ ms}) = 110 \text{ ms}$$

which is nearly twice as long as in the previous case. The reason is that each disk access is very costly; if possible, the data should be organized to minimize the number of accesses.

### 7.1.1 B-Trees

In database programs where most information is stored on disks or tapes, the time penalty for accessing secondary storage can be significantly reduced by the proper choice of data structures. *B-trees* (Bayer and McCreight, 1972) are one such approach.

A B-tree operates closely with secondary storage and can be tuned to reduce the impediments imposed by this storage. One important property of B-trees is the size of each node, which can be made as large as the size of a block. The number of keys in

one node can vary depending on the sizes of the keys, organization of the data (are only keys kept in the nodes or entire records?), and of course, on the size of a block. Block size varies for each system. It can be 512 bytes, 4KB, or more; block size is the size of each node of a B-tree. The amount of information stored in one node of the B-tree can be rather large.

A *B-tree of order  $m$*  is a multiway search tree with the following properties:

1. The root has at least two subtrees unless it is a leaf.
2. Each nonroot and each nonleaf node holds  $k - 1$  keys and  $k$  references to subtrees where  $\lceil m/2 \rceil \leq k \leq m$ .
3. Each leaf node holds  $k - 1$  keys where  $\lceil m/2 \rceil \leq k \leq m$ .
4. All leaves are on the same level.<sup>1</sup>

According to these conditions, a B-tree is always at least half full, has few levels, and is perfectly balanced.

A node of a B-tree is usually implemented as a `class` containing an array of  $m - 1$  cells for keys, an  $m$ -cell array of references to other nodes, and possibly other information facilitating tree maintenance, such as the number of keys in a node and a leaf/nonleaf flag, as in

```
class BTreeNode {
    int m = 4;
    boolean leaf = true;
    int keyTally = 1;
    int keys[] = new int[m-1];
    BTreeNode references[] = new BTreeNode[m];
    BTreeNode(int key) {
        keys[0] = key;
        for (int i = 0; i < m; i++)
            references[i] = null;
    }
}
```

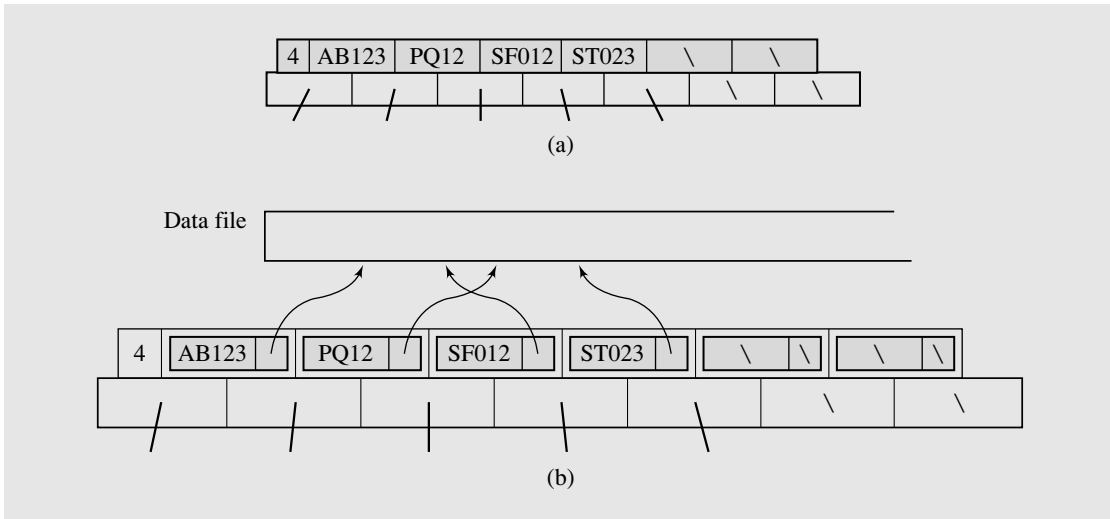
Usually,  $m$  is large (50–500) so that information stored in one page or block of secondary storage can fit into one node. Figure 7.3a contains an example of a B-tree of order 7 that stores codes for some items. In this B-tree, the keys appear to be the only objects of interest. In most cases, however, such codes would only be fields of larger structures. In these cases, the array `keys` is an array of objects, each having a unique identifier field (such as the identifying code in Figure 7.3a) and an address field, the address of the entire record on secondary storage, as in Figure 7.3b.<sup>2</sup> If the contents of

<sup>1</sup> In this definition, the order of a B-tree specifies the *maximum* number of children. Sometimes nodes of a B-tree of order  $m$  are defined as having  $k$  keys and  $k + 1$  references where  $m \leq k \leq 2m$ , which specifies the *minimum* number of children.

<sup>2</sup> Figure 7.3 reflects the logic of the situation; in actual implementation, the array `keys` is an array of references to objects, and each object has a key field and an address field.



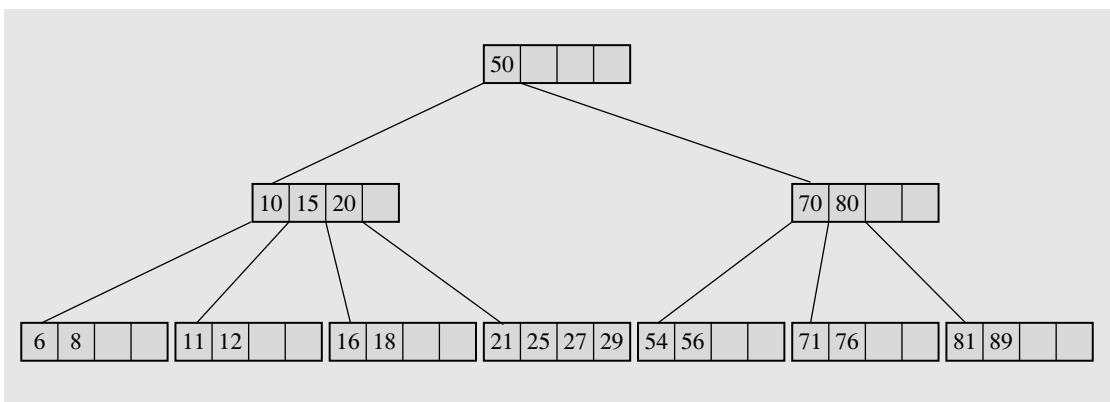
**FIGURE 7.3** One node of a B-tree of order 7 (a) without and (b) with an additional indirection.



one such node also reside in secondary storage, each key access would require two secondary storage accesses. In the long run, this is better than keeping the entire records in the nodes, because in this case, the nodes can hold a very small number of such records. The resulting B-tree is much deeper, and search paths through it are much longer than in a B-tree with the addresses of records.

From now on, B-trees will be shown in an abbreviated form without explicitly indicating keyTa11y or the reference fields, as in Figure 7.4.

**FIGURE 7.4** A B-tree of order 5 shown in an abbreviated form.



*Searching in a B-Tree*

An algorithm for finding a key in a B-tree is simple, and is coded as follows:

```
public BTreeNode BTreeSearch(int key) {
    return BTreeSearch(key, root);
}
protected BTreeNode BTreeSearch(int key, BTreeNode node) {
    if (node != null) {
        int i = 1;
        for ( ; i <= node.keyTally && node.keys[i-1] < key; i++);
        if (i > node.keyTally || node.keys[i-1] > key)
            return BTreeSearch(key, node.references[i-1]);
        else return node;
    }
    else return null;
}
```

The worst case of searching is when a B-tree has the smallest allowable number of references per nonroot node,  $q = \lceil m/2 \rceil$ , and the search has to reach a leaf (for either a successful or an unsuccessful search). In this case, in a B-tree of height  $h$ , there are

$$\begin{aligned}
 & 1 \text{ key in the root} + \\
 & 2(q-1) \text{ keys on the second level} + \\
 & 2q(q-1) \text{ keys on the third level} + \\
 & 2q^2(q-1) \text{ keys on the fourth level} + \\
 & \quad \vdots \\
 & 2q^{h-2}(q-1) \text{ keys in the leaves (level } h) = \\
 & 1 + \left( \sum_{i=0}^{h-2} 2q^i \right) (q-1) \text{ keys in the B-tree}
 \end{aligned}$$

With the formula for the sum of the first  $n$  elements in a geometric progression,

$$\sum_{i=0}^n q^i = \frac{q^{n+1} - 1}{q - 1}$$

the number of keys in the worst-case B-tree can be expressed as

$$1 + 2(q-1) \left( \sum_{i=0}^{h-2} q^i \right) = 1 + 2(q-1) \left( \frac{q^{h-1} - 1}{q-1} \right) = -1 + 2q^{h-1}$$

The relation between the number  $n$  of keys in any B-tree and the height of the B-tree is then expressed as

$$n \geq -1 + 2q^{h-1}$$

Solving this inequality for the height  $h$  results in

$$h \leq \log_q \frac{n+1}{2} + 1$$

This means that for a sufficiently large order  $m$ , the height is small even for a large number of keys stored in the B-tree. For example, if  $m = 200$  and  $n = 2,000,000$ , then

$h \leq 4$ ; in the worst case, finding a key in this B-tree requires four seeks. If the root can be kept in memory at all times, this number can be reduced to only three seeks into secondary storage.

### *Inserting a Key into a B-Tree*

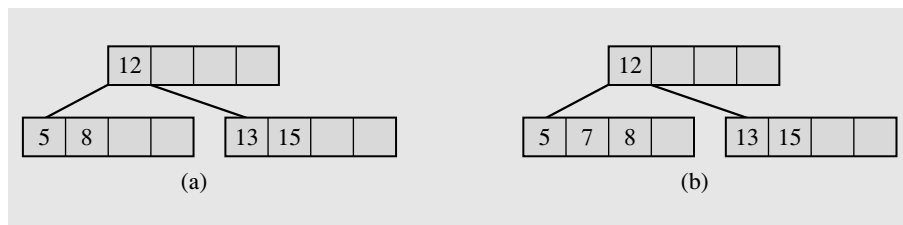
Both the insertion and deletion operations appear to be somewhat challenging if we remember that all leaves have to be at the last level. Not even balanced binary trees require that. Implementing insertion becomes easier when the strategy of building a tree is changed. When inserting a node into a binary search tree, the tree is always built from top to bottom, resulting in unbalanced trees. If the first incoming key is the smallest, then this key is put in the root, and the root does not have a left subtree unless special provisions are made to balance the tree.

But a tree can be built from the bottom up so that the root is an entity always in flux, and only at the end of all insertions can we know for sure the contents of the root. This strategy is applied to inserting keys into B-trees. In this process, given an incoming key, we go directly to a leaf and place it there, if there is room. When the leaf is full, another leaf is created, the keys are divided between these leaves, and one key is promoted to the parent. If the parent is full, the process is repeated until the root is reached and a new root created.

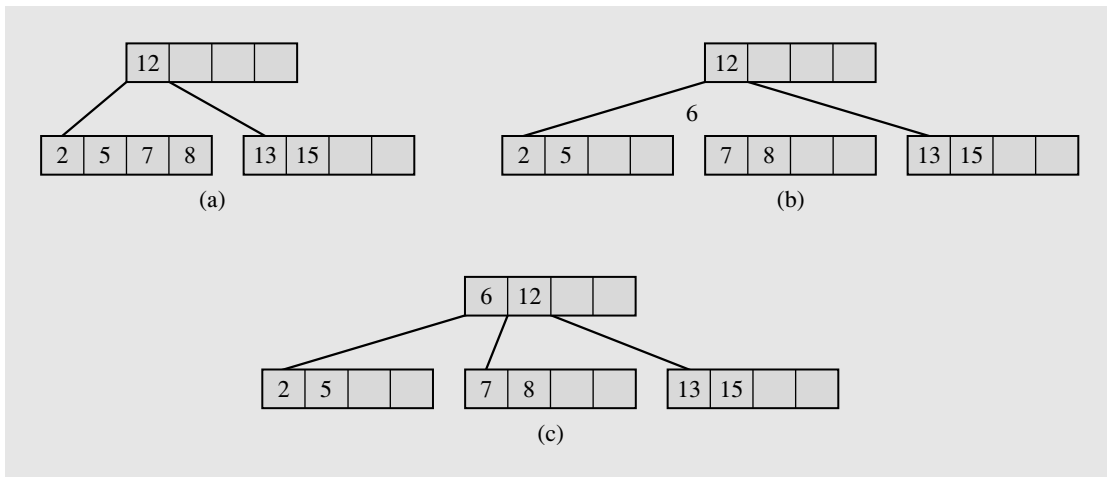
To approach the problem more systematically, there are three common situations encountered when inserting a key into a B-tree.

1. A key is placed in a leaf that still has some room, as in Figure 7.5. In a B-tree of order 5, a new key, 7, is placed in a leaf, preserving the order of the keys in the leaf so that key 8 must be shifted to the right by one position.

**FIGURE 7.5** A B-tree (a) before and (b) after insertion of the number 7 into a leaf that has available cells.



2. The leaf in which a key should be placed is full, as in Figure 7.6. In this case, the leaf is *split*, creating a new leaf, and half of the keys are moved from the full leaf to the new leaf. But the new leaf has to be incorporated into the B-tree. The middle key is moved to the parent, and a reference to the new leaf is placed in the parent as well. The same procedure can be repeated for each internal node of the B-tree so that each such split adds one more node to the B-tree. Moreover, such a split guarantees that each leaf never has less than  $\lceil m/2 \rceil - 1$  keys.

**FIGURE 7.6** Inserting the number 6 into a full leaf.

3. A special case arises if the root of the B-tree is full. In this case, a new root and a new sibling of the existing root have to be created. This split results in two new nodes in the B-tree. For example, after inserting the key 13 in the third leaf in Figure 7.7a, the leaf is split (as in case 2), a new leaf is created, and the key 15 is about to be moved to the parent, but the parent has no room for it (7.7b). So the parent is split (7.7c), but now two B-trees have to be combined into one. This is achieved by creating a new root and moving the middle key to it (7.7d). It should be obvious that it is the only case in which the B-tree increases in height.

An algorithm for inserting keys in B-trees follows:

```

BTreeInsert (K)
  find a leaf node to insert K;
  while (true)
    find a proper position in array keys for K;
    if node is not full
      insert K and increment keyTally;
      return;
    else split node into node1 and node2; // node1 = node, node2 is new;
         distribute keys and references evenly between node1 and node2 and
         initialize properly their keyTally's;
         K = middle key;
         if node was the root
           create a new root as parent of node1 and node2;
           put K and references to node1 and node2 in the root, and set its keyTally to 1;
           return;
         else node = its parent; // and now process the node's parent;

```

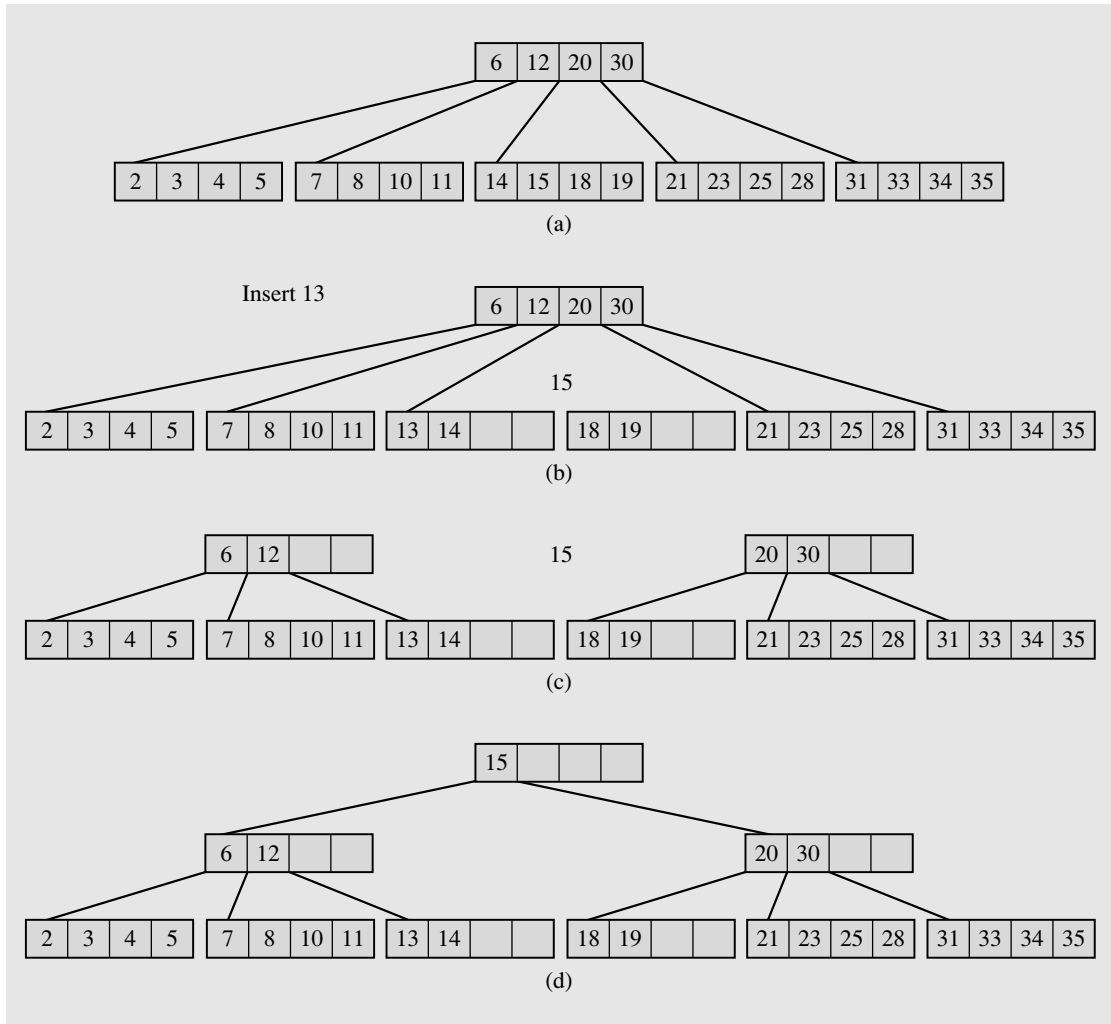
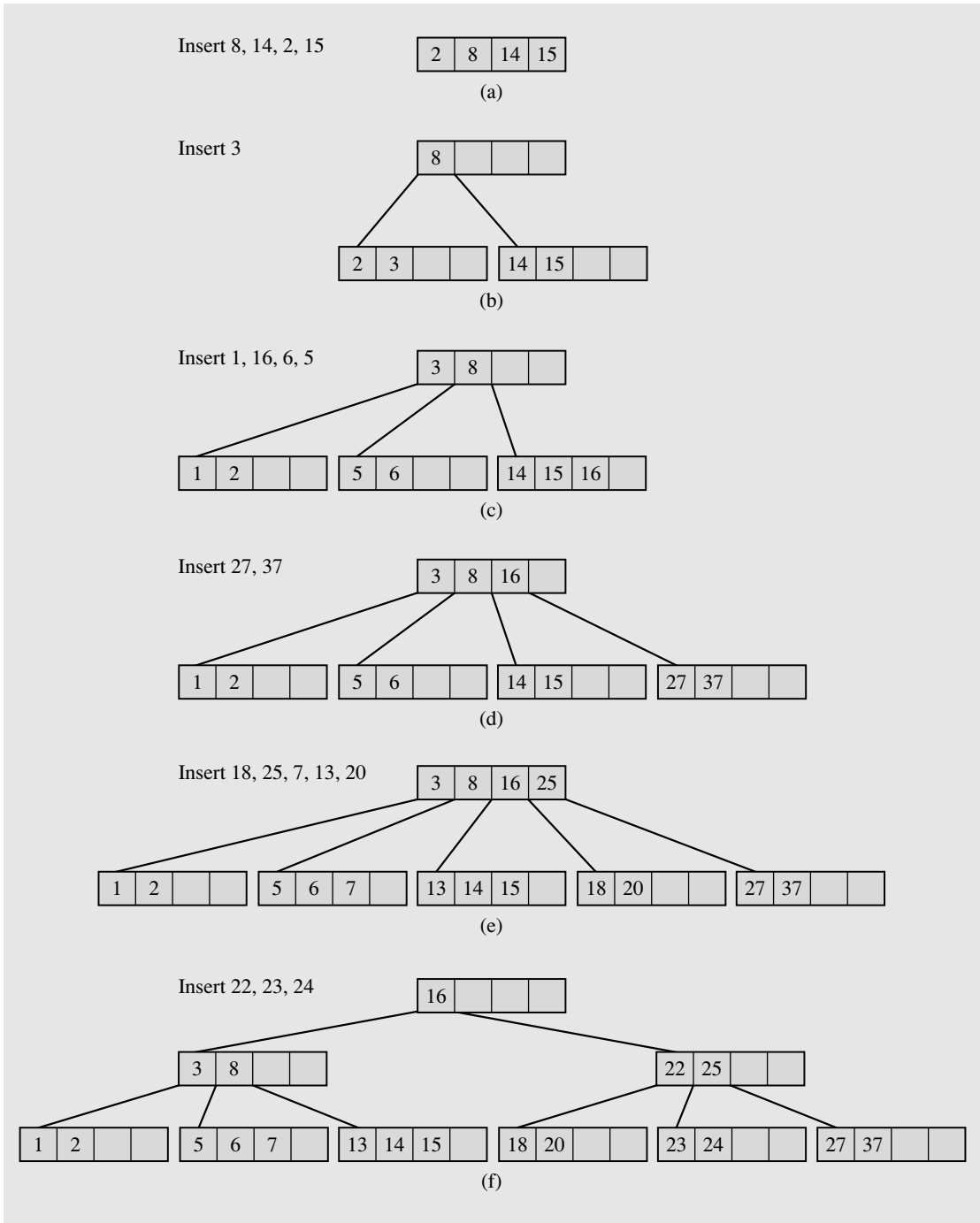
**FIGURE 7.7** Inserting the number 13 into a full leaf.

Figure 7.8 shows the growth of a B-tree of order 5 in the course of inserting new keys. Note that at all times the tree is perfectly balanced.

A variation of this insertion strategy uses *presplitting*: When a search is made from the top down for a particular key, each visited node that is already full is split. In this way, no split has to be propagated upward.

How often are node splits expected to occur? A split of the root node of a B-tree creates two new nodes. All other splits add only one more node to the B-tree. During the construction of a B-tree of  $p$  nodes,  $p - h$  splits have to be performed, where  $h$  is the height of the B-tree. Also, in a B-tree of  $p$  nodes, there are at least

**FIGURE 7.8** Building a B-tree of order 5 with the `BTreeInsert()` algorithm.



$$1 + (\lceil m/2 \rceil - 1)(p - 1)$$

keys. The rate of splits with respect to the number of keys in the B-tree can be given by

$$\frac{p - h}{1 + (\lceil m/2 \rceil - 1)(p - 1)}$$

After dividing the numerator and denominator by  $p - h$  and observing that  $\frac{1}{p-h} \rightarrow 0$  and  $\frac{p-1}{p-h} \rightarrow 1$  with the increase of  $p$ , the average probability of a split is

$$\frac{1}{\lceil m/2 \rceil - 1}$$

For example, for  $m = 10$ , this probability is equal to .25; for  $m = 100$ , it is .02; and for  $m = 1,000$ , it is .002, and expectedly so: The larger the capacity of one node, the less frequently splits occur.

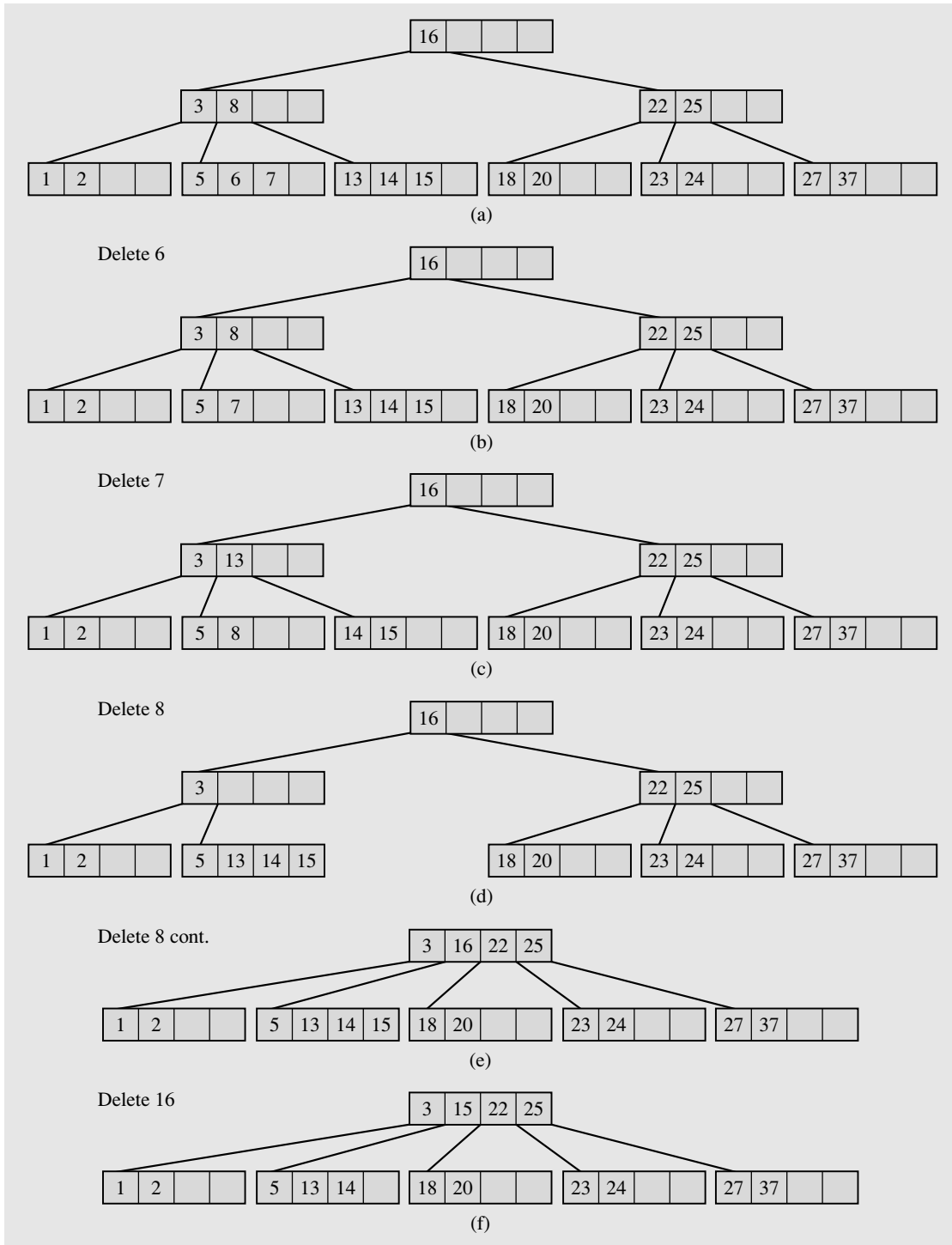
### Deleting a Key from a B-Tree

Deletion is to a great extent a reversal of insertion, although it has more special cases. Care has to be taken to avoid allowing any node to be less than half full after a deletion. This means that nodes sometimes have to be merged.

In deletion, there are two main cases: deleting a key from a leaf and deleting a key from a nonleaf node. In the latter case, we will use a procedure similar to `deleteByCopying()` used for binary search trees (Section 6.6).

1. Deleting a key from a leaf.
  - 1.1 If, after deleting a key  $K$ , the leaf is at least half full and only keys greater than  $K$  are moved to the left to fill the hole (see Figures 7.9a–b), this is the inverse of insertion’s case 1.
  - 1.2 If, after deleting  $K$ , the number of keys in the leaf is less than  $\lceil m/2 \rceil - 1$ , causing an *underflow*:
    - 1.2.1 If there is a left or right sibling with the number of keys exceeding the minimal  $\lceil m/2 \rceil - 1$ , then all keys from this leaf and this sibling are *redistributed* between them by moving the separator key from the parent to the leaf and moving the middle key from the node and the sibling combined to the parent (see Figures 7.9b–c).
    - 1.2.2 If the leaf underflows and the number of keys in its siblings is  $\lceil m/2 \rceil - 1$ , then the leaf and a sibling are *merged*; the keys from the leaf, from its sibling, and the separating key from the parent are all put in the leaf, and the sibling node is discarded. The keys in the parent are moved if a hole appears (see Figures 7.9c–d). This can initiate a chain of operations if the parent underflows. The parent is now treated as though it were a leaf, and either step 1.2.2 is repeated until step 1.2.1 can be executed or the root of the tree has been reached. This is the inverse of insertion’s case 2.

**FIGURE 7.9** Deleting keys from a B-tree.





- 1.2.2.1 A particular case results in merging a leaf or nonleaf with its sibling when its parent is the root with only one key. In this case, the keys from the node and its sibling, along with the only key of the root, are put in the node, which becomes a new root, and both the sibling and the old root nodes are discarded. This is the only case when two nodes disappear at one time. Also, the height of the tree is decreased by one (see Figures 7.9c–e). This is the inverse of insertion’s case 3.
2. Deleting a key from a nonleaf. This may lead to problems with tree reorganization. Therefore, deletion from a nonleaf node is reduced to deleting a key from a leaf. The key to be deleted is replaced by its immediate predecessor (the successor could also be used), which can only be found in a leaf. This successor key is deleted from the leaf, which brings us to the preceding case 1 (see Figures 7.9e–f).

Here is the deletion algorithm:

```

BTreeDelete(K)
  node = BTreeSearch(K, root);
  if (node != null)
    if node is not a leaf
      find a leaf with the closest predecessor S of K;
      copy S over K in node;
      node = the leaf containing S;
      delete S from node;
    else delete K from node;
  while (true)
    if node does not underflow
      return;
    else if there is a sibling of node with enough keys
      redistribute the keys between node and its sibling;
      return;
    else if node's parent is the root
      if the parent has only one key
        merge node, its sibling, and the parent to form a new root;
      else merge node and its sibling;
      return;
    else merge node and its sibling;
      node = its parent;

```

B-trees, according to their definition, are guaranteed to be at least 50 percent full, so it may happen that 50 percent of space is basically wasted. How often does this happen? If it happens too often, then the definition must be reconsidered or some other restrictions imposed on this B-tree. Analyses and simulations, however, indicate that after a series of numerous random insertions and deletions, the B-tree is approximately 69 percent full (Yao, 1978), after which the changes in the percentage of occupied cells are very small. But it is very unlikely that the B-tree will ever be filled to the brim, so some additional stipulations are in order.

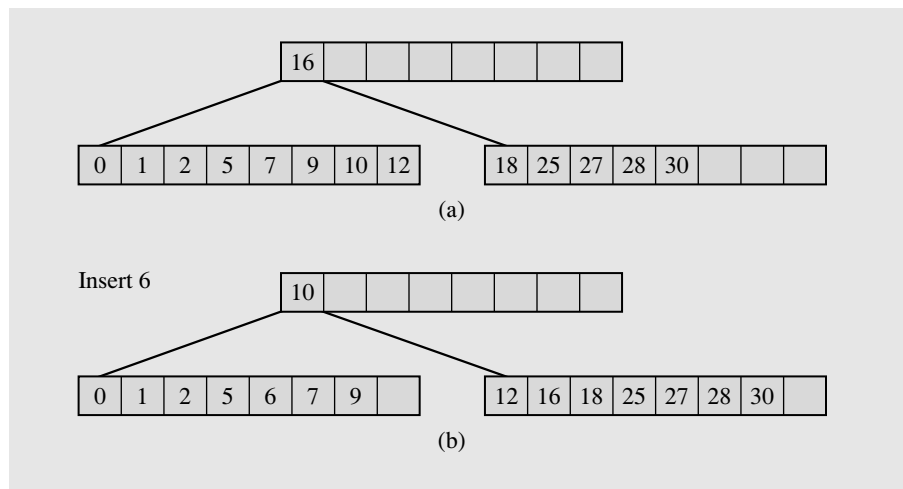
### 7.1.2 B\*-Trees

Because each node of a B-tree represents a block of secondary memory, accessing one node means one access of secondary memory, which is expensive compared to accessing keys in the node residing in primary memory. Therefore, the fewer nodes that are created, the better.

A *B\*-tree* is a variant of the B-tree, and was introduced by Donald Knuth and named by Douglas Comer. In a *B\*-tree*, all nodes except the root are required to be at least two-thirds full, not just half full as in a B-tree. More precisely, the number of keys in all nonroot nodes in a B-tree of order  $m$  is now  $k$  for  $\lfloor \frac{2m-1}{3} \rfloor \leq k \leq m-1$ . The frequency of node splitting is decreased by delaying a split, and when the time comes, by splitting two nodes into three, not one into two. The average utilization of *B\*-tree* is 81 percent (Leung, 1984).

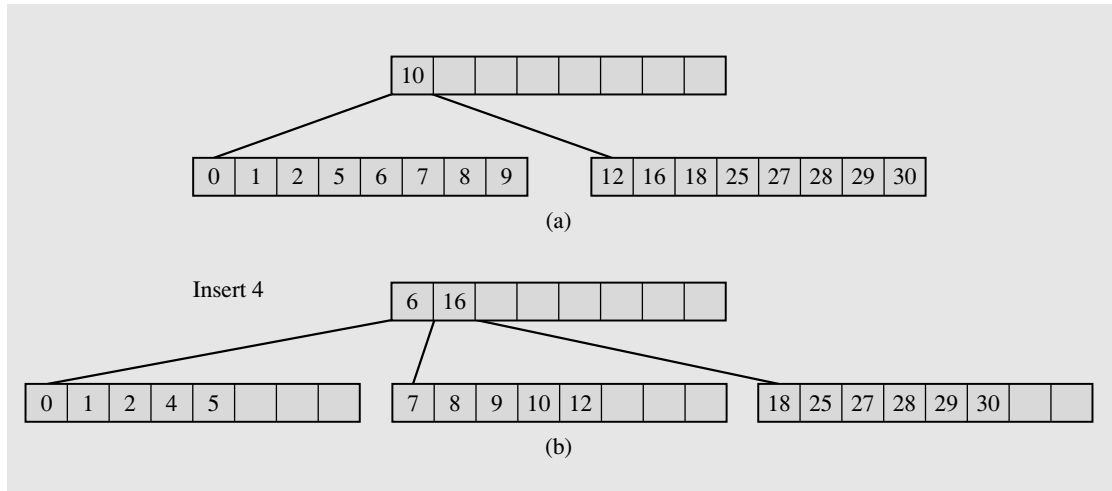
A split in a *B\*-tree* is delayed by attempting to redistribute the keys between a node and its sibling when the node overflows. Figure 7.10 contains an example of a *B\*-tree* of order 9. The key 6 is to be inserted into the left node, which is already full. Instead of splitting the node, all keys from this node and its sibling are evenly divided and the median key, key 10, is put into the parent. Notice that this evenly divides not only the keys, but also the free spaces so that the node which was full is now able to accommodate one more key.

**FIGURE 7.10** Overflow in a *B\*-tree* is circumvented by redistributing keys between an overflowing node and its sibling.



If the sibling is also full, a split occurs: One new node is created, the keys from the node and its sibling (along with the separating key from the parent) are evenly divided among three nodes, and two separating keys are put into the parent (see Figure 7.11). All three nodes participating in the split are guaranteed to be two-thirds full.

**FIGURE 7.11** If a node and its sibling are both full in a B\*-tree, a split occurs: A new node is created and keys are distributed between three nodes.



Note that, as may be expected, this increase of a *fill factor* can be done in a variety of ways, and some database systems allow the user to choose a fill factor between .5 and 1. In particular, a B-tree whose nodes are required to be at least 75 percent full is called a B\*\*-tree (McCreight, 1977). The latter suggests a generalization: A *B<sup>n</sup>-tree* is a B-tree whose nodes are required to be  $\frac{n+1}{n+2}$  full.

### 7.1.3 B<sup>+</sup>-Trees

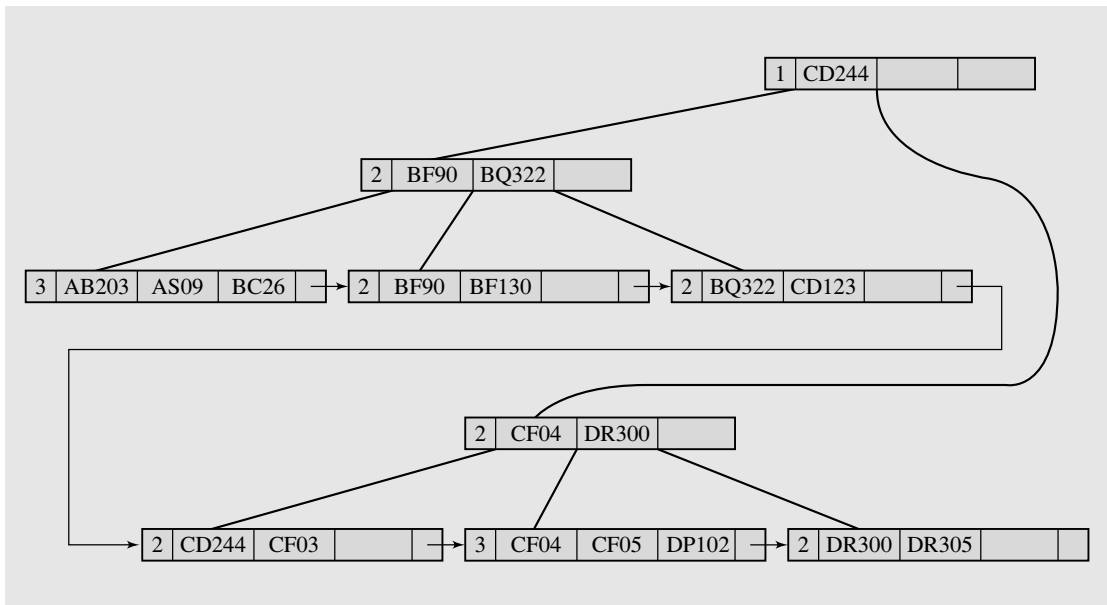
Because one node of a B-tree represents one secondary memory page or block, the passage from one node to another requires a time-consuming page change. Therefore, we would like to make as few node accesses as possible. What happens if we request that all the keys in the B-tree be printed in ascending order? An inorder tree traversal can be used that is easy to implement, but for nonterminal nodes, only one key is displayed at a time and then another page has to be accessed. Therefore, we would like to enhance B-trees to allow us to access data sequentially in a faster manner than using inorder traversal. A *B<sup>+</sup>-tree* offers a solution (Wedekind, 1974).<sup>3</sup>

In a B-tree, references to data are made from any node of the tree, but in a B<sup>+</sup>-tree, these references are made only from the leaves. The internal nodes of a B<sup>+</sup>-tree are indexes for fast access of data; this part of the tree is called an *index set*. The leaves have a different structure than other nodes of the B<sup>+</sup>-tree, and usually they are linked sequentially to form a *sequence set* so that scanning this list of leaves results in data given in ascending order. Hence, a B<sup>+</sup>-tree is truly a B plus tree: It is an index implemented as a

<sup>3</sup> Wedekind, who considered these trees to be only “a slight variation” of B-trees, called them B<sup>\*</sup>-trees.

regular B-tree plus a linked list of data. Figure 7.12 contains an example of a B<sup>+</sup>-tree. Note that internal nodes store keys, references to other nodes, and a key count. Leaves store keys, references to records in a data file associated with the keys, and references to the next leaf.

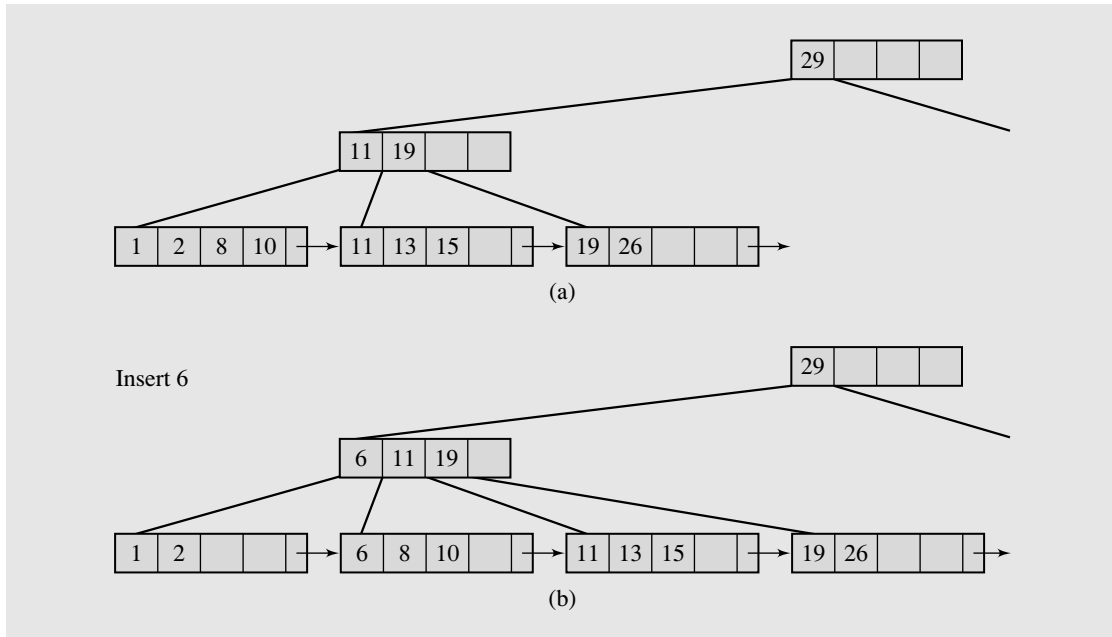
**FIGURE 7.12** An example of a B<sup>+</sup>-tree of order 4.



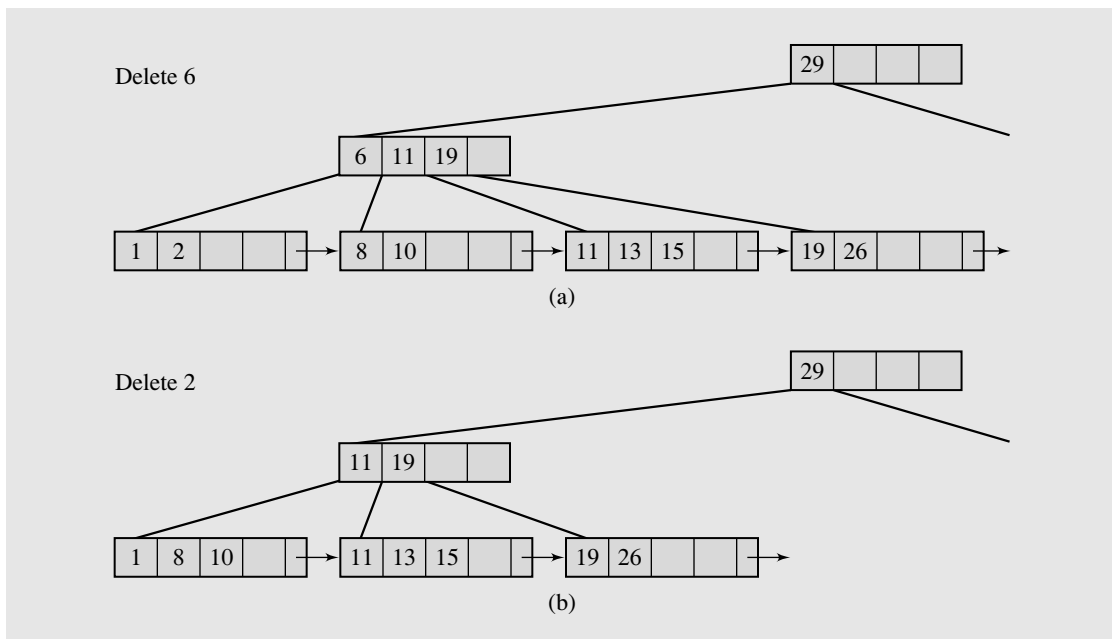
Operations on B<sup>+</sup>-trees are not very different from operations on B-trees. Inserting a key into a leaf that still has some room requires putting the keys of this leaf in order. No changes are made in the index set. If a key is inserted into a full leaf, the leaf is split, the new leaf node is included in the sequence set, all keys are distributed evenly between the old and the new leaves, and the first key from the new node is copied (not moved, as in a B-tree) to the parent. If the parent is not full, this may require local reorganization of the keys of the parent (see Figure 7.13). If the parent is full, the splitting process is performed the same way as in B-trees. After all, the index set is a B-tree. In particular, keys are moved, not copied, in the index set.

Deleting a key from a leaf leading to no underflow requires putting the remaining keys in order. No changes are made to the index set. In particular, if a key that occurs only in a leaf is deleted, then it is simply deleted from the leaf but can remain in the internal node. The reason is that it still serves as a proper guide when navigating down the B<sup>+</sup>-tree because it still properly separates keys between two adjacent children even if the separator itself does not occur in either of the children. The deletion of key 6 from the tree in Figure 7.13b results in the tree in Figure 7.14a. Note that the number 6 is not deleted from an internal node.

**FIGURE 7.13** An attempt to insert the number 6 into the first leaf of a B<sup>+</sup>-tree.



**FIGURE 7.14** Actions after deleting the number 6 from the B<sup>+</sup>-tree in Figure 7.13b.



When the deletion of a key from a leaf causes an underflow, then either the keys from this leaf and the keys of a sibling are redistributed between this leaf and its sibling or the leaf is deleted and the remaining keys are included in its sibling. Figure 7.14b illustrates the latter case. After deleting the number 2, an underflow occurs and two leaves are combined to form one leaf. The separating key is removed from the parent and keys in the parent are put in order. Both these operations require updating the separator in the parent. Also, removing a leaf may trigger merges in the index set.

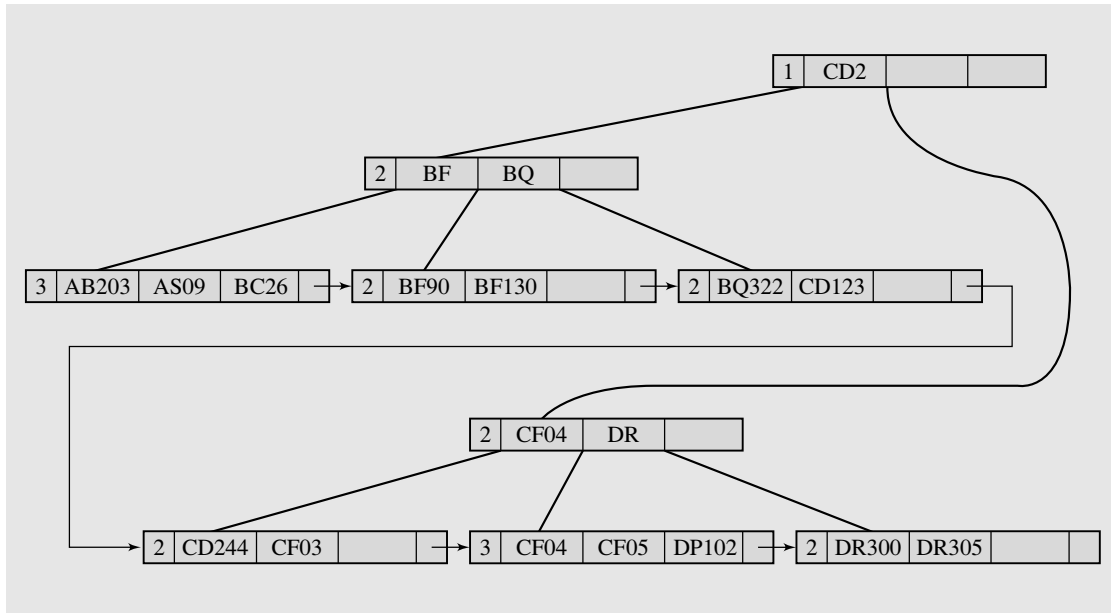
### 7.1.4 Prefix B<sup>+</sup>-Trees

If a key occurred in a leaf and in an internal node of a B<sup>+</sup>-tree, then it is enough to delete it only from the leaf because the key retained in the node is still a good guide in subsequent searches. So it really does not matter whether a key in an internal node is in any leaf or not. What counts is that it is an acceptable separator for keys in adjacent children; for example, for two keys  $K_1$  and  $K_2$ , the separator  $s$  must meet the condition  $K_1 < s \leq K_2$ . This property of the separator keys is also retained if we make keys in internal nodes as small as possible by removing all redundant contents from them and still have a properly working B<sup>+</sup>-tree.

A *simple prefix B<sup>+</sup>-tree* (Bayer and Unterauer, 1977) is a B<sup>+</sup>-tree in which the chosen separators are the shortest prefixes that allow us to distinguish two neighboring index keys. For example, in Figure 7.12, the left child of the root has two keys, BF90 and BQ322. If a key is less than BF90, the first leaf is chosen; if it is less than BQ322, the second leaf is the right pick. But observe that we also have the same results, if instead of BF90, keys BF9 or just BF are used and instead of BQ322, one of three prefixes of this key is used: BQ32, BQ3, or just BQ. After choosing the shortest prefixes of both keys, if any key is less than BF, the search ends up in the first leaf, and if the key is less than BQ, the second leaf is chosen; the result is the same as before. Reducing the size of the separators to the bare minimum does not change the result of the search. It only makes separators smaller. As a result, more separators can be placed in the same node, whereby such a node can have more children. The entire B<sup>+</sup>-tree can have fewer levels, which reduces the branching factor and makes processing the tree faster.

This reasoning does not stop at the level of parents of the leaves. It is carried over to any other level so that the entire index set of a B<sup>+</sup>-tree is filled with prefixes (see Figure 7.15).

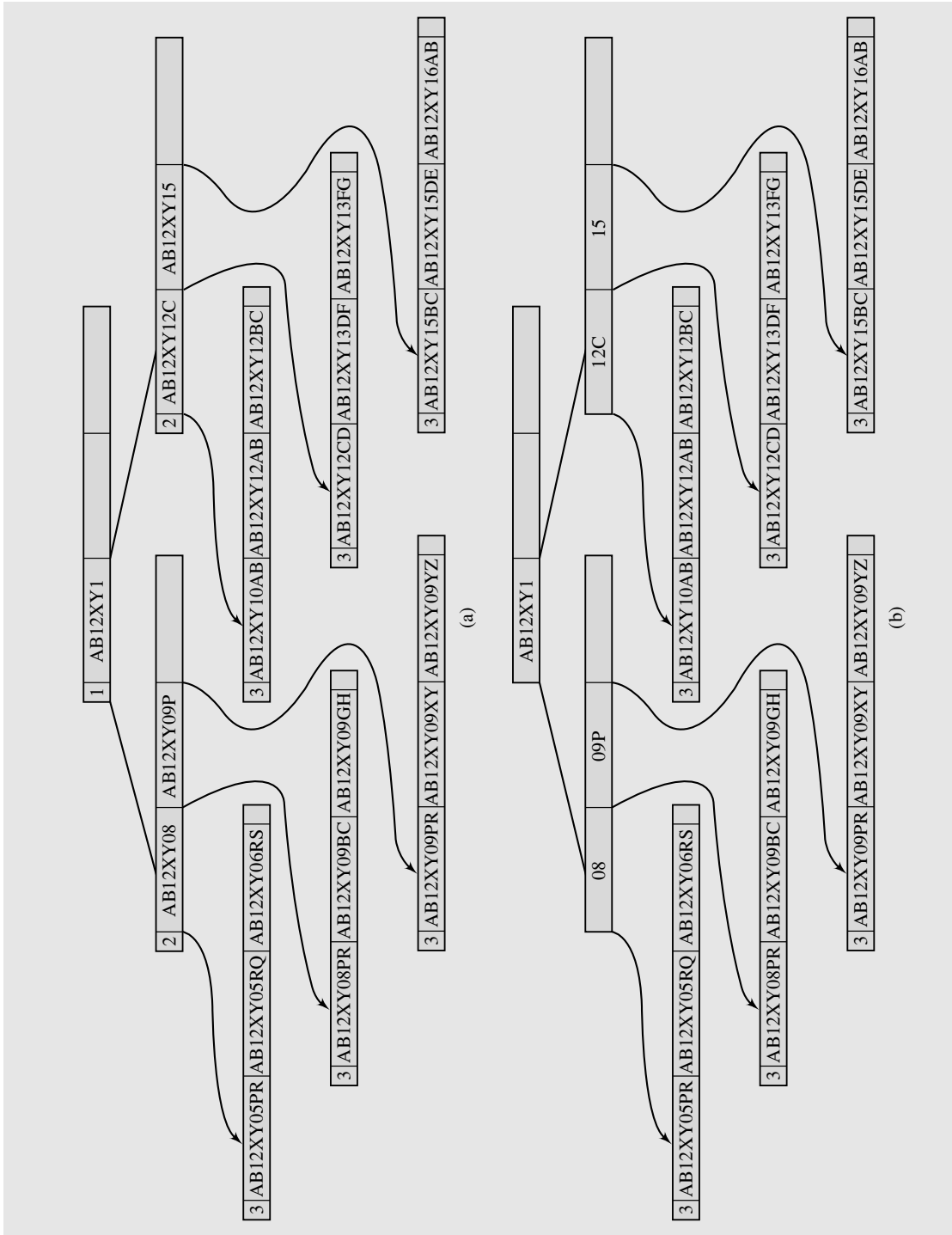
The operations on simple prefix B<sup>+</sup>-trees are much the same as the operations on B<sup>+</sup>-trees with certain modifications to account for prefixes used as separators. In particular, after a split, the first key from the new node is neither moved nor copied to the parent, but the shortest prefix is found that differentiates it from the prefix of the last key in the old node; and the shortest prefix is then placed in the parent. For deletion, however, some separators retained in the index set may turn out to be too long, but to make deletion faster, they do not have to be immediately shortened.

**FIGURE 7.15** A B<sup>+</sup>-tree from Figure 7.12 presented as a simple prefix B<sup>+</sup>-tree.

The idea of using prefixes as separators can be carried even further if we observe that prefixes of prefixes can be omitted in lower levels of the tree, which is the idea behind a *prefix B<sup>+</sup>-tree*. This method works particularly well if prefixes are long and repetitious. Figure 7.16 contains an example. Each key in the tree has a prefix AB12XY, and this prefix appears in all internal nodes. This is redundant; Figure 7.16b shows the same tree with “AB12XY” stripped from prefixes in children of the root. To restore the original prefix, the key from the parent node, except for its last character, becomes the prefix of the key found in the current node. For example, the first cell of the child of the root in Figure 7.16b has the key “08.” The last character of the key in the root is discarded and the obtained prefix, “AB12XY,” is put in front of “08.” The new prefix, “AB12XY08,” is used to determine the direction of the search.

How efficient are prefix B<sup>+</sup>-trees? Experimental runs indicate that there is almost no difference in the time needed to execute algorithms in B<sup>+</sup>-trees and simple prefix B<sup>+</sup>-trees, but prefix B<sup>+</sup>-trees need 50–100 percent more time. In terms of disk accesses, there is no difference between these trees in the number of times the disk is accessed for trees of 400 nodes or less. For trees of 400–800 nodes, both simple prefix B<sup>+</sup>-trees and prefix B<sup>+</sup>-trees require 20–25 percent fewer accesses (Bayer and Unterauer, 1977). This indicates that simple prefix B<sup>+</sup>-trees are a viable option, but prefix B<sup>+</sup>-trees remain largely of theoretical interest.

**FIGURE 7.16** (a) A simple prefix B<sup>+</sup>-tree and (b) its abbreviated version presented as a prefix B<sup>+</sup>-tree.





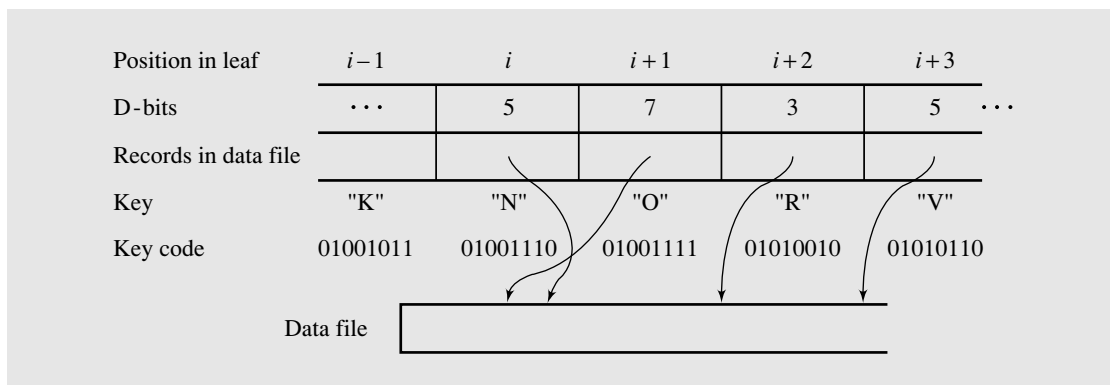
### 7.1.5 Bit-Trees

A very interesting approach is, in a sense, taking to the extreme the prefix B<sup>+</sup>-tree method. In this method, bytes are used to specify separators. In *bit-trees*, the bit level is reached (Ferguson, 1992).

The bit-tree is based on the concept of a *distinction bit (D-bit)*. A distinction bit  $D(K,L)$  is the number of the most significant bit that differs in two keys,  $K$  and  $L$ , and  $D(K,L) = \text{key-length-in-bits} - 1 - \lfloor \lg(K \text{ xor } L) \rfloor$ . For example, the D-bit for the letters “K” and “N”, whose ASCII codes are 01001011 and 01001110, is 5, the position at which the first difference between these keys has been detected;  $D(\text{“K”}, \text{“N”}) = 8 - 1 - \lfloor \lg 5 \rfloor = 5$ .

A bit-tree uses D-bits to separate keys in the leaves only; the remaining part of the tree is a prefix B<sup>+</sup>-tree. This means that the actual keys and entire records from which these keys are extracted are stored in a data file so that the leaves can include much more information than would be the case when the keys were stored in them. The leaf entries refer to the keys indirectly by specifying distinction bits between keys corresponding to neighboring locations in the leaf (see Figure 7.17).

**FIGURE 7.17** A leaf of a bit-tree.



Before presenting an algorithm for processing data with bit-trees, some useful properties of D-bits need to be discussed. All keys in the leaves are kept in ascending order. Therefore,  $D_i = D(K_{i-1}, K_i)$  indicates the leftmost bit that is different in these keys; this bit is always 1 because  $K_{i-1} < K_i$  for  $1 \leq i < m$  ( $=$  order of the tree). For example,  $D(\text{“N”}, \text{“O”}) = D(01001110, 01001111) = 7$ , and the bit in position 7 is on, all preceding bits in both keys being the same.

Let  $j$  be the first position in a leaf for which  $D_j < D_i$  and  $j > i$ ;  $D_j$  is the first D-bit smaller than a preceding  $D_i$ . In this case, for all keys between positions  $i$  and  $j$  in this leaf, the  $D_i$  bit is 1. In the example in Figure 7.17,  $j = i + 2$ , because  $D_{i+2}$  is the first D-bit following position  $i$  that is smaller than  $D_i$ . Bit 5 in key “O” in position  $i + 1$  is 1 as it is 1 in key “N” in position  $i$ .

The algorithm for searching a key using a bit-tree leaf is

```

bitTreeSearch(K)
  R = record R0;
  for i = 1 to m-1
    if the Di bit in K is 1
      R = Ri;
    else skip all following D-bits until a smaller D-bit is found;
  read record R from data file;
  if K == key from record R
    return R;
  else return -1;

```

Using this algorithm, we can search for “V” assuming that, in Figure 7.17,  $i - 1 = 0$  and  $i + 3$  is the last entry in the leaf.  $R$  is initialized to  $R_0$ , and  $i$  to 1.

1. In the first iteration of the `for` loop, bit  $D_1 = 5$  in key “V” = 01010110 is checked, and because it is 1,  $R$  is assigned  $R_1$ .
2. In the second iteration, bit  $D_2 = 7$  is tested. It is 0, but nothing is skipped, as required by the `else` statement, because right away a D-bit is found that is smaller than 7.
3. The third iteration: bit  $D_3 = 3$  is 1, so  $R$  becomes  $R_3$ .
4. In the fourth iteration, bit  $D_4 = 5$  is checked again, and because it is 1,  $R$  is assigned  $R_5$ . This is the last entry in the leaf; the algorithm is finished, and  $R_5$  is properly returned.

What happens if the desired key is not in the data file? We can try to locate “S” = 01010011 using the same assumptions on  $i - 1$  and  $i + 3$ . Bit  $D_1 = 5$  is 0, so the position with D-bit 7 is skipped, and because bit  $D_3 = 3$  in “S” is 1, the algorithm would return record  $R_3$ . To prevent this, `bitTreeSearch()` checks whether the record it found really corresponds with the desired key. If not, a negative number is returned to indicate failure.

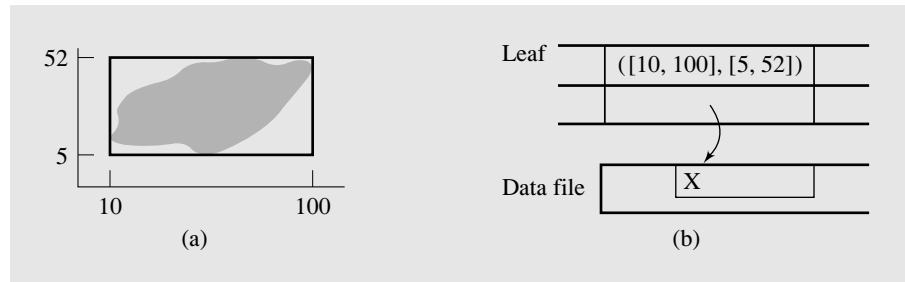
### 7.1.6 R-Trees

Spatial data are the kind of objects that are utilized frequently in many areas. Computer-assisted design, geographical data, and VLSI design are examples of domains in which spatial data are created, searched, and deleted. This type of data requires special data structures to be processed efficiently. For example, we may request that all counties in an area specified by geographical coordinates be printed or that all buildings in walking distance from city hall be identified. Many different data structures have been developed to accommodate this type of data. One example is an *R-tree* (Guttman, 1984).

An R-tree of order  $m$  is a B-treelike structure containing at least  $m$  entries in one node for some  $m \leq$  maximum number allowable per one node (except the root). Hence, an R-tree is not required to be at least half full.

A leaf in an R-tree contains entries of the form  $(rect, id)$  where  $rect = ([c_1^1, c_1^2], \dots, [c_n^1, c_n^2])$  is an  $n$ -dimensional rectangle,  $c_p^1$  and  $c_p^2$  are coordinates along the same axis, and  $id$  is a reference to a record in a data file.  $rect$  is the smallest rectangle containing object  $id$ ; for example, the entry in a leaf corresponding to an object  $X$  on a Cartesian plane as in Figure 7.18 is the pair  $(([10, 100], [5, 52]), X)$ .

**FIGURE 7.18** An area  $X$  on the Cartesian plane enclosed tightly by the rectangle  $([10, 100], [5, 52])$ . The rectangle parameters and the area identifier are stored in a leaf of an R-tree.



A nonleaf node cell entry has the form  $(rect, child)$  where  $rect$  is the smallest rectangle encompassing all the rectangles found in  $child$ . The structure of an R-tree is not identical to the structure of a B-tree: The former can be viewed as a series of  $n$  keys and  $n$  references corresponding to these keys.

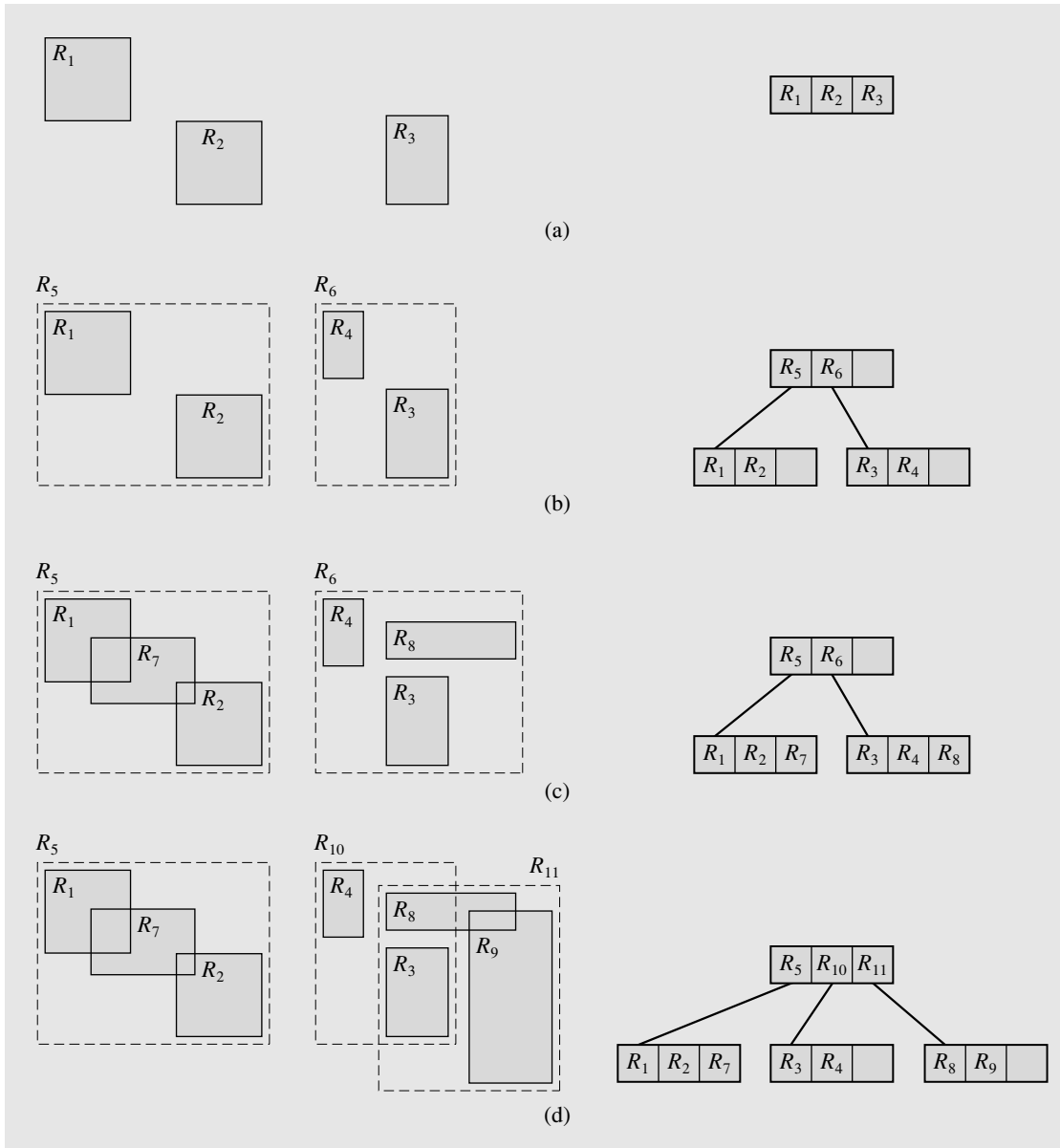
Inserting new rectangles in an R-tree is made in B-tree fashion, with splits and redistribution. A crucial operation is finding a proper leaf in which to insert a rectangle  $rect$ . When moving down the R-tree, the subtree chosen in the current node is the one that corresponds to the rectangle requiring the least enlargement to include  $rect$ . If a split occurs, new encompassing rectangles have to be created. The detailed algorithm is more involved because, among other things, it is not obvious how to divide rectangles of a node being split. The algorithm should generate rectangles that enclose rectangles of the two resulting nodes and are minimal in size.

Figure 7.19 contains an example of inserting four rectangles into an R-tree. After inserting the first three rectangles,  $R_1$ ,  $R_2$ , and  $R_3$ , only the root is full (Figure 7.19a). Inserting  $R_4$  causes a split, resulting in the creation of two encompassing rectangles (Figure 7.19b). Inserting  $R_7$  changes nothing, and inserting  $R_8$  causes rectangle  $R_6$  to be extended to accommodate  $R_8$  (Figure 7.19c). Figure 7.19d shows another split after entering  $R_9$  in the R-tree.  $R_6$  is discarded, and  $R_{10}$  and  $R_{11}$  are created.

A rectangle  $R$  can be contained in many other encompassing rectangles, but it can be stored only once in a leaf. Therefore, a search procedure may take a wrong path at some level  $h$  when it sees that  $R$  is enclosed by another rectangle found in a node on this level. For example, rectangle  $R_3$  in Figure 7.19d is enclosed by both  $R_{10}$  and  $R_{11}$ . Because  $R_{10}$  is before  $R_{11}$  in the root, the search accesses the middle leaf when looking for  $R_3$ . However, if  $R_{11}$  preceded  $R_{10}$  in the root, following the path corresponding with  $R_{11}$  would be unsuccessful. For large and high R-trees, this overlapping becomes excessive.

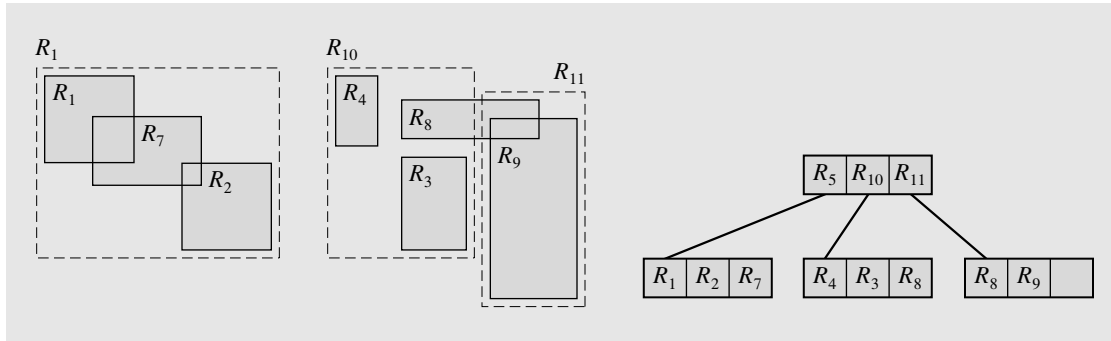
A modification of R-trees, called an  $R^+$ -tree, removes this overlap (Sellis, Rousopoulos, and Faloutsos, 1987; Stonebraker, Sellis, and Hanson, 1986). The encompassing rectangles are no longer overlapping, and each encompassing rectangle is associated with all the rectangles it intersects. But now the data rectangle can be found in more than one leaf. For example, Figure 7.20 shows an  $R^+$ -tree constructed

**FIGURE 7.19** Building an R-tree.



after the data rectangle  $R_9$  was inserted into the R-tree in Figure 7.19c. Figure 7.20 replaces Figure 7.19d. Note that  $R_8$  can be found in two leaves, because it is intersected by two encompassing rectangles,  $R_{10}$  and  $R_{11}$ . Operations on an  $R^+$ -tree make it difficult to ensure without further manipulation that nodes are at least half full.

**FIGURE 7.20** An R<sup>+</sup>-tree representation of the R-tree in Figure 7.19d after inserting the rectangle  $R_9$  in the tree in Figure 7.19c.



### 7.1.7 2–4 Trees

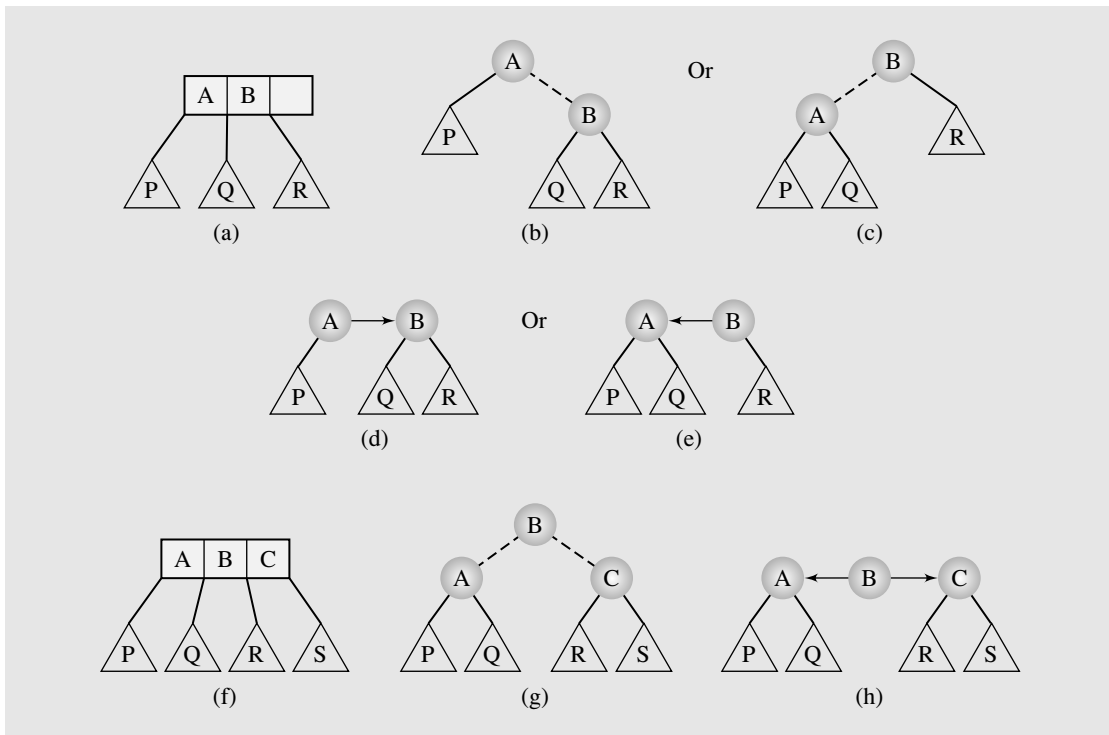
This section discusses a special case of B-tree, a B-tree of order 4. This B-tree was first discussed by Rudolf Bayer, who called it a *symmetric binary B-tree* (Bayer, 1972), but it is usually called a *2–3–4 tree* or just a *2–4 tree*. A 2–4 tree seems to offer no new perspectives, but quite the opposite is true. In B-trees, the nodes are large to accommodate the contents of one block read from secondary storage. In 2–4 trees, on the other hand, only one, two, or at most three elements can be stored in one node. Unless the elements are very large, so large that three of them can fill up one block on a disk, there seems to be no reason for even mentioning B-trees of such a small order. Although B-trees have been introduced in the context of handling data on secondary storage, it does not mean that they have to be used only for that purpose.

We spent an entire chapter discussing binary trees, in particular, binary search trees, and developing algorithms that allow quick access to the information stored in these trees. Can B-trees offer a better solution to the problem of balancing or traversing binary trees? We now return to the topics of binary trees and processing data in memory.

B-trees are well-suited to challenge the algorithms used for binary search trees, because a B-tree by its nature has to be balanced. No special treatment is needed in addition to building a tree: Building a B-tree balances it at the same time. Instead of using binary search trees, we may use B-trees of small order such as 2–4 trees. However, if these trees are implemented as structures similarly to B-trees, there are three locations per node to store up to three keys and four locations per node to store up to four references. In the worst case, half of these cells are unused, and on the average, 69 percent are used. Because space is much more at a premium in main memory than in secondary storage, we would like to avoid this wasted space. Therefore, 2–4 trees are transformed into binary tree form in which each node holds only one key. Of course, the transformation has to be done in a way that permits an unambiguous restoration of the original B-tree form.

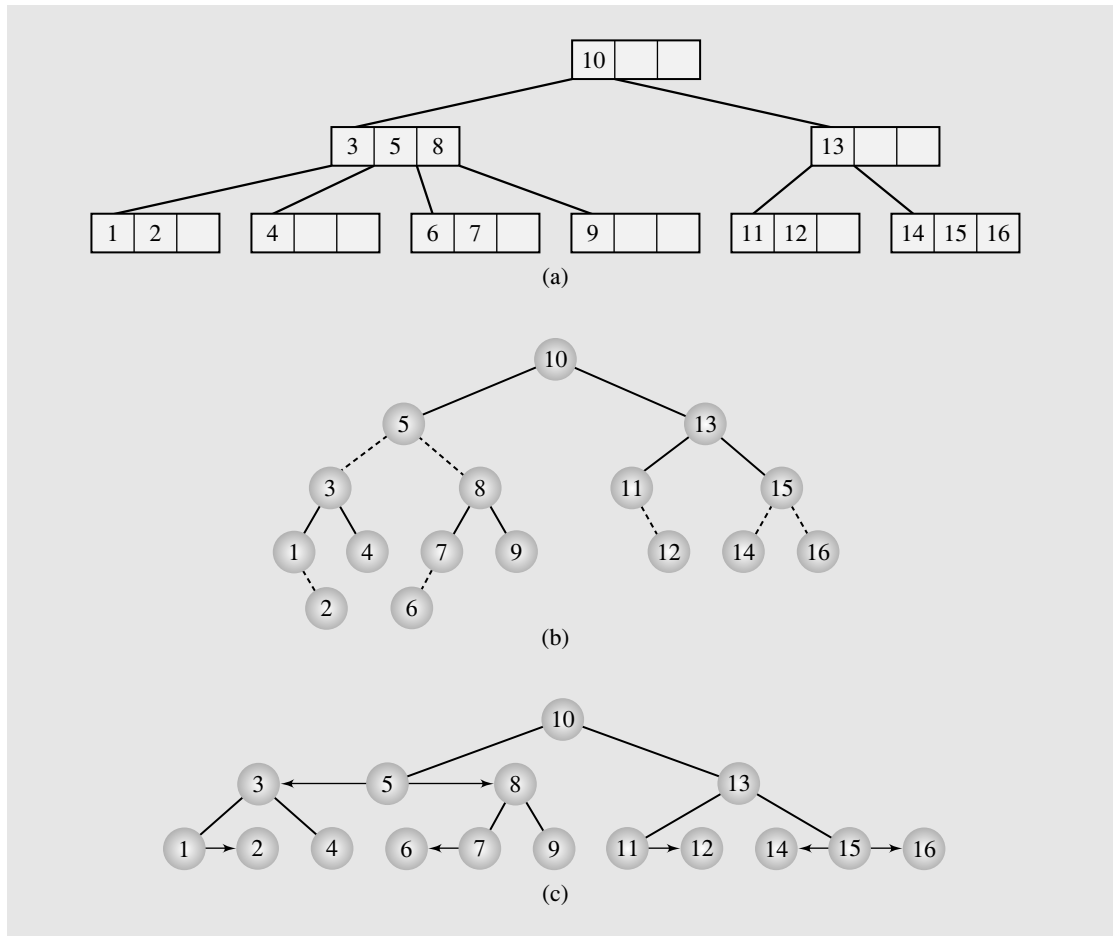
To represent a 2–4 tree as a binary tree, two types of links between nodes are used: One type indicates links between nodes representing keys belonging to the same node of a 2–4 tree, and another represents regular parent–children links. Bayer called them *horizontal* and *vertical* pointers or, more cryptically,  $\rho$ -pointers and  $\delta$ -pointers; Guibas and Sedgwick in their dichromatic framework use the names *red* and *black* pointers. Not only are the names different, but the trees are also drawn a bit differently. Figure 7.21 shows nodes with two and three keys, which are called *3-nodes* and *4-nodes*, and their equivalent representations. Figure 7.22 shows a complete 2–4 tree and its binary tree equivalents. Note that the red links are drawn with dashed lines. The *red-black tree* better represents the exact form of a binary tree; the *vertical-horizontal trees*, or the *vh-trees*, are better in retaining the shape of 2–4 trees and in having leaves shown as though they were on the same level. Also, vh-trees lend themselves easily to representing B-trees of any order; the red-black trees do not.

**FIGURE 7.21** (a) A 3-node represented (b–c) in two possible ways by red-black trees and (d–e) in two possible ways by vh-trees. (f) A 4-node represented (g) by a red-black tree and (h) by a vh-tree.



Both red-black trees and vh-trees are binary trees. Each node has two references that can be interpreted in two ways. To make a distinction between the interpretation applied in a given context, a flag for each of the references is used.

**FIGURE 7.22** (a) A 2–4 tree represented (b) by a red-black tree and (c) by a binary tree with horizontal and vertical pointers.



Vh-trees have the following properties:

- The path from the root to any null node contains the same number of vertical links.
- No path from the root can have two horizontal links in a row.

The operations performed on vh-trees should be the same as on binary trees, although their implementation is much more involved. Only searching is the same: To find a key in a vh-tree, no distinction is made between the different types of references. We can use the same searching procedure as for binary search trees: If the key is found, stop. If the key in the current node is larger than the one we are looking for, we go to the left subtree; otherwise, we go to the right subtree.

To find the cost of searching a key in the worst case in a vh-tree, observe that in each such tree we would like to find a correspondence between the number of nodes in the tree and its height. First, observe that if the shortest path to a leaf consists of vertical links only, then the longest path to another leaf can begin and end with horizontal links and have vertical and horizontal links used interchangeably. Therefore,

$$path_{longest} \leq 2 \cdot path_{shortest} + 1$$

with equality if the shortest and the longest paths are as just described. Now we would like to find the minimum number of nodes  $n_{min}$  in a vh-tree of a particular height  $h$ . Consider first vh-trees of odd height. Figure 7.23a shows a vh-tree of height 7 and, implicitly, of heights 1, 3, and 5. Beginning with  $h = 3$ , we can observe a geometric progression in the number of nodes added to the tree of previous odd height

$$\begin{array}{l} h = 3 \ 5 \ 7 \ 9 \ \dots \\ \text{number of new nodes} = 3 \ 6 \ 12 \ 24 \ \dots \end{array}$$

The sum of the first  $m$  terms of a geometric sequence is expressed with the formula  $a_1 \frac{q^m - 1}{q - 1}$  and thus after adding 1 representing the root,

$$n_{min} = 3 \frac{2^{\frac{h-1}{2}} - 1}{2 - 1} + 1 = 3 \cdot 2^{\frac{h-1}{2}} - 2$$

From this we have

$$n \geq 3 \cdot 2^{\frac{h-1}{2}} - 2$$

and so

$$2 \lg \frac{n+2}{3} + 1 \geq h$$

For even heights, as exemplified in Figure 7.23b for a vh-tree of height 8, we obtain

$$\begin{array}{l} h = 2 \ 4 \ 6 \ 8 \ \dots \\ \text{number of new nodes} = 2 \ 4 \ 8 \ 16 \ \dots \end{array}$$

$$n_{min} = 2(2^{\frac{h}{2}} - 1)$$

and consequently

$$n \geq n_{min} = 2(2^{\frac{h}{2}} - 1)$$

from which

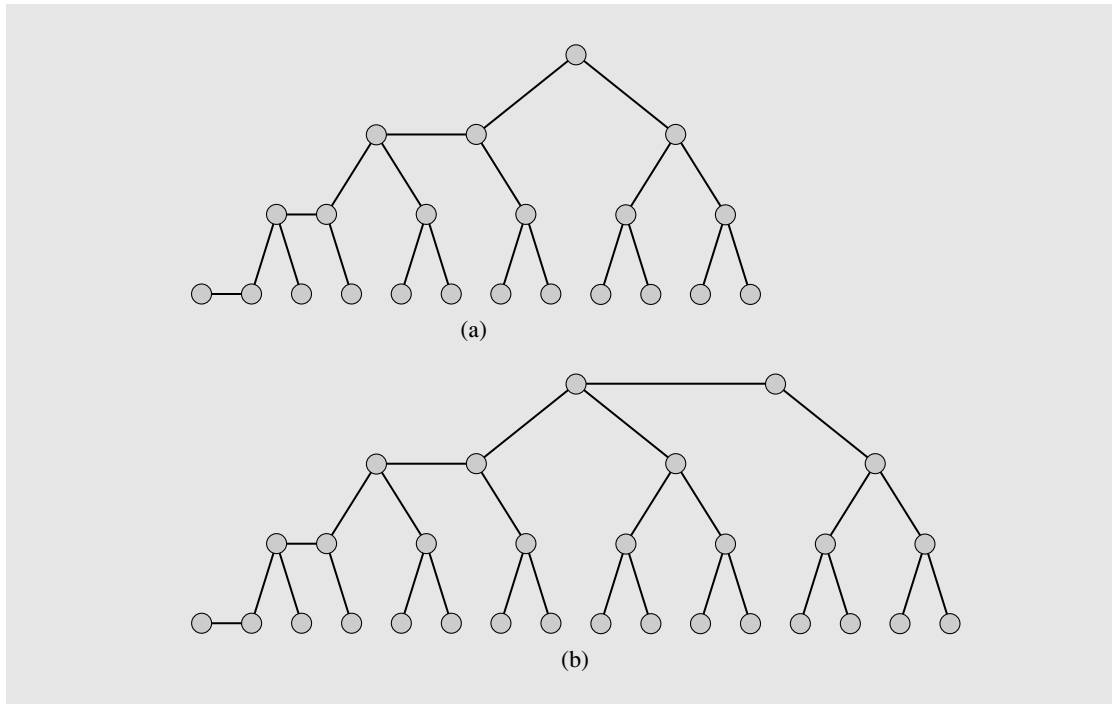
$$2 \lg(n+2) - 2 \geq h$$

It is simple to check that for any  $n$ , the bound for even heights is larger, so it can be used as an upper bound for all heights. The lower bound is given by the height of a complete binary tree. The number of nodes in such a tree of height  $h$  was found to be  $n = 2^h - 1$  (see Figure 6.35), from which

$$\lg(n+1) \leq h \leq 2 \lg(n+2) - 2$$

This is the worst case of search, when searching has to reach the leaf level.

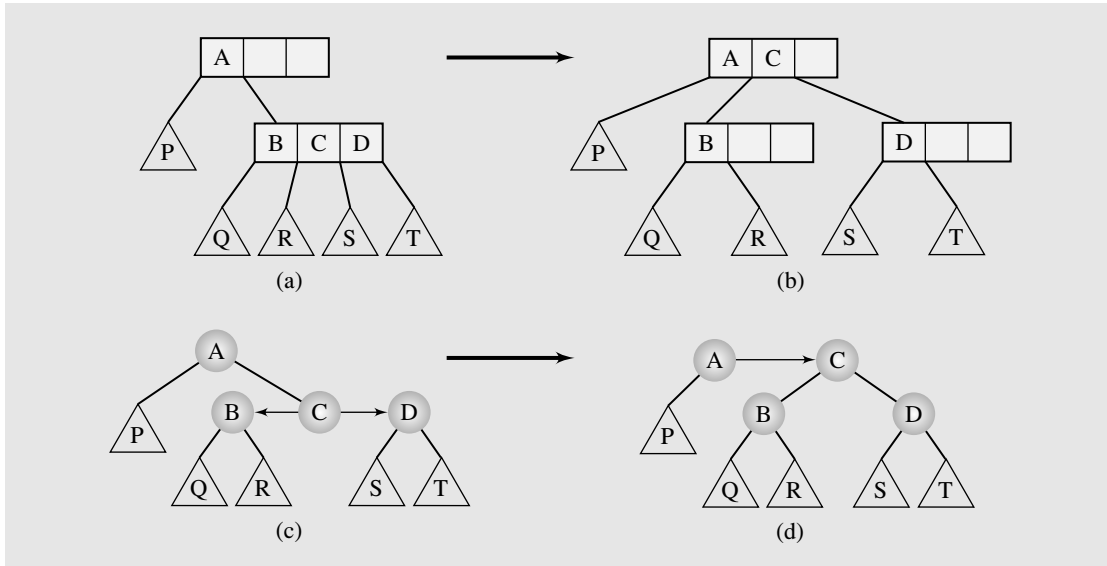


**FIGURE 7.23** (a) A vh-tree of height 7; (b) a vh-tree of height 8.

Insertions restructure the tree by adding one more node and one more link to the tree. Should it be a horizontal or vertical link? Deletions restructure the tree as well by removing one node and one link, but this may lead to two consecutive horizontal links. These operations are not as straightforward as for binary search trees, because some counterparts of node splitting and node merging have to be represented in vh-trees.

A good idea when splitting 2–4 trees, as already indicated in the discussion of B-trees, is to split nodes when going down the tree while inserting a key. If a 4-node is encountered, it is split before descending further down the tree. Because this splitting is made from the top down, a 4-node can be a child of either a 2-node or a 3-node (with the usual exception: unless it is the root). Figures 7.24a and 7.24b contain an example. Splitting the node with keys *B*, *C*, and *D* requires creating a new node. The two nodes involved in splitting (Figure 7.24a) are  $4/6$  full and three nodes after splitting are  $4/9$  full ( $6/8$  and  $7/12$ , respectively, for reference fields). Splitting nodes in 2–4 trees results in poor performance. However, if the same operations are performed on their vh-tree equivalents, the operation is remarkably efficient. In Figures 7.24c and 7.24d, the same split is performed on a vh-tree, and the operation requires changing only two flags from horizontal to vertical and one from vertical to horizontal: Only three bits are reset!

**FIGURE 7.24** (a–b) Split of a 4-node attached to a node with one key in a 2–4 tree. (c–d) The same split in a vh-tree equivalent to these two nodes.



Resetting these three flags suggests the following algorithm:

`flagFlipping(node)`

*if node's both links are horizontal*

*reset the flag corresponding to the link from node's parent to node to horizontal;*

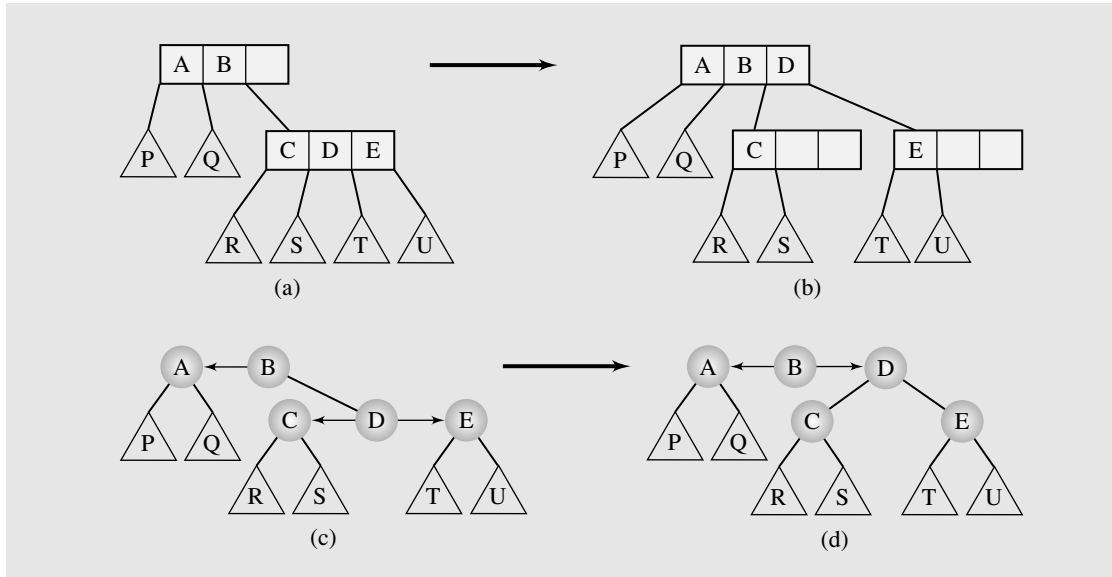
*reset flags in node to vertical;*

For the second case, when 4-node is a child of a 3-node and the links are as in Figure 7.25a, the split results in the 2–4 tree as in Figure 7.25b; applying *flagFlipping* to a vh-tree equivalent requires that only three bits be reset (Figures 7.25c and 7.25d).

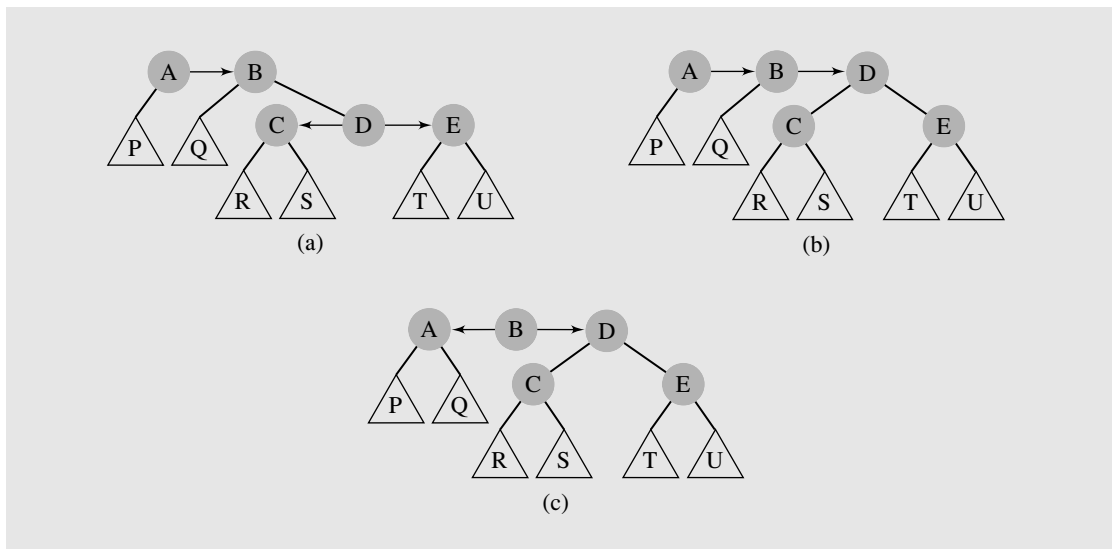
Figure 7.21 indicates that the same node of a 2–4 tree can have two equivalents in a vh-tree. Therefore, the situation in Figure 7.25a can be reflected not only by the tree in Figure 7.25c, but also by the tree in Figure 7.26a. If we proceed as before, by changing three flags as in Figure 7.25d, the tree in Figure 7.26b ends up with two consecutive horizontal links, which has no counterpart in any 2–4 tree. In this case, the three flag flips have to be followed by a rotation; namely, node *B* is rotated about node *A*, two flags are flipped, and the tree in Figure 7.26c is the same as in Figure 7.25d.

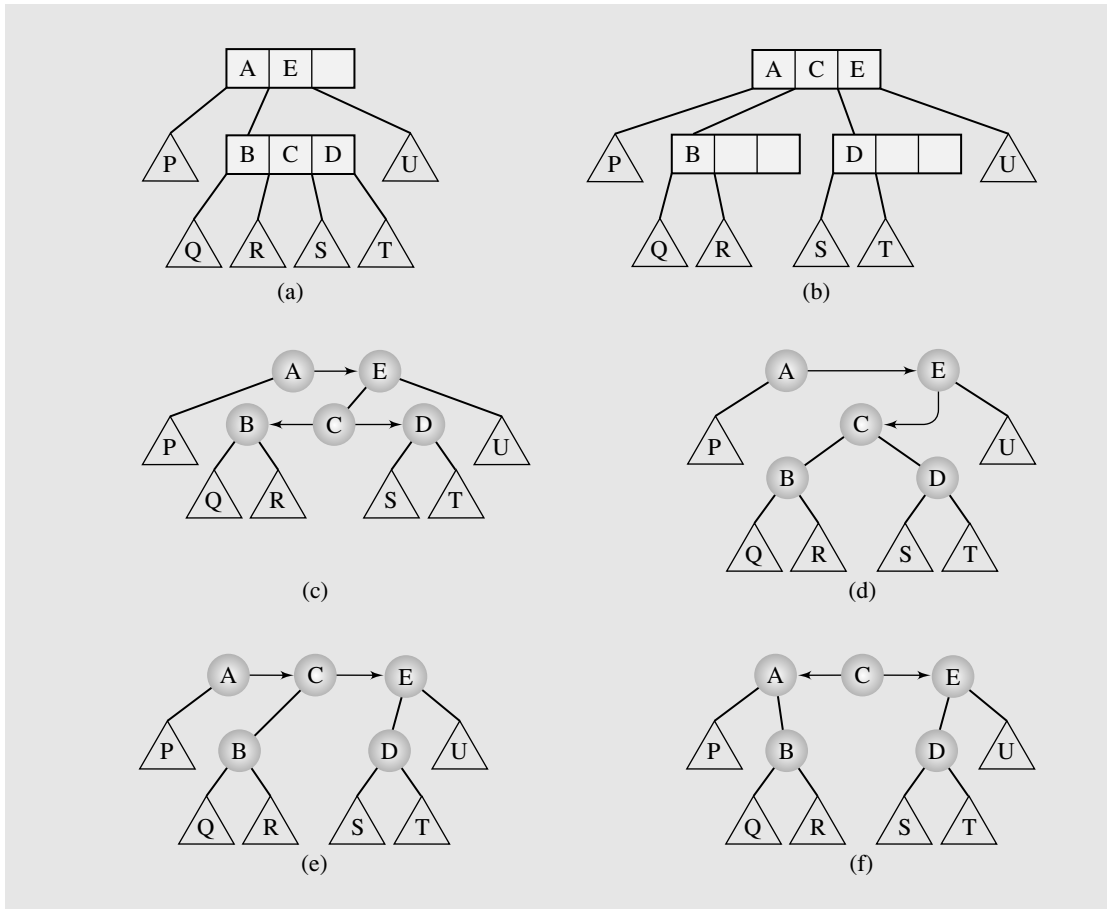
Figure 7.27a contains another way in which a 4-node is attached to a 3-node in a 2–4 tree before splitting. Figure 7.27b shows the tree after splitting. Applying *flagFlipping* to the tree in Figure 7.27c yields the tree in Figure 7.27d with two consecutive horizontal links. To restore the vh-tree property, two rotations and four flag flips are needed: Node *C* is rotated about node *E*, which is followed by two flag flips (Figure 7.27e), and then node *C* about node *A*, which is also followed by two flag flips. This all leads to the tree in Figure 7.27f.

**FIGURE 7.25** (a–b) Split of a 4-node attached to a 3-node in a 2–4 tree and (c–d) a similar operation performed on one possible vh-tree equivalent to these two nodes.



**FIGURE 7.26** Fixing a vh-tree that has consecutive horizontal links.



**FIGURE 7.27** A 4-node attached to a 3-node in a 2–4 tree.

We presented four configurations leading to a split (Figures 7.24c, 7.25c, 7.26a, 7.27c). This number has to be doubled if the mirror images of the situation just analyzed are added. However, in only four cases does flag flipping have to be followed by one or two rotations to restore the vh-property. It is important to notice that the height of the tree measured in the number of vertical links (plus 1) does not grow as the result of rotation(s). Also, because of splitting any 4-node along the path to the insertion position, the new node is inserted into either a 2-node or a 3-node; that is, a new node is always attached to its parent through a horizontal link, so the height of the tree, after inserting a node, does not change either. The only case in which the height does grow is when the root is a 4-node. This is the ninth case for the split.

The vh-tree property can be distorted not only after a 4-node split, but also after including a new node in the tree, which leads to one or two rotations, as indicated at the end of the following insertion algorithm.

```

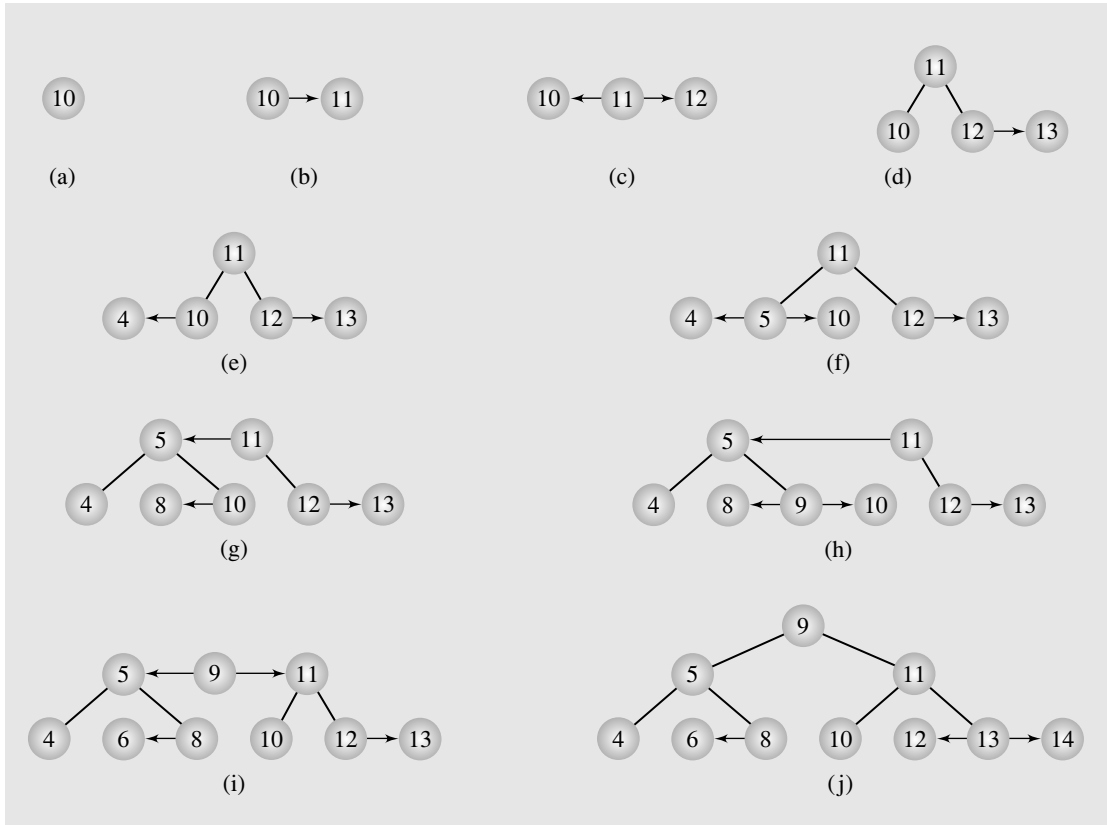
VHTreeInsert(K)
  create newNode and initialize it;
  if VHTree is empty
    root = newNode;
    return;
  for (p = root, prev = null; p != null;)
    if both p's flags are horizontal
      set them to vertical; //flag flipping
      mark prev's link connecting it with p as horizontal;
      if links connecting parent of prev with prev and prev with p are both marked horizontal
        if both these links are left or both are right //Figure 26b
          rotate prev about its parent;
        else rotate p about prev and then p about its new parent; //Figure 27d
    prev = p;
    if (p.key > K)
      p = p.left;
    else p = p.right;
  attach newNode to prev;
  mark prev's flag corresponding to its link to newNode to horizontal;
  if link from prev's parent to prev is marked horizontal
    rotate prev about its parent or
    first rotate newNode about prev and then newNode about its new parent;

```

Figure 7.28 contains an example of inserting a sequence of numbers. Note that a double rotation has to be made in the tree in Figure 7.28h while 6 is being inserted. First 9 is rotated about 5 and then 9 is rotated about 11.

Removing a node can be accomplished by deletion by copying, as described in Section 6.6.2; that is, an immediate successor (or predecessor) is found in the tree, copied over the element to be removed, and the node that holds the original successor is removed from the tree. The successor is found by going one step to the right from the node that holds the element to be removed and then as far as possible to the left. The successor is on the last level of vertical links; that is, the successor may have one left descendant accessible through a horizontal link (in Figure 7.28h, a successor of 11, 12, has one such descendant, 13), or none (like 8, a successor of 5). In a plain binary search tree it is easy to remove such a successor. In the vh-tree, however, it may not be so. If the successor is connected to its parent with a horizontal link, it can simply be detached (like node 8 after copying 8 over 5 to remove number 5 from the tree in Figure 7.28h), but if the connection of the successor with no descendants with the parent is established through the vertical link, then removing this successor may violate the vh-tree property. For example, to remove 9 in the tree in Figure 7.28j, the successor 10 is found and copied over 9 and then node 10 is removed, but the path to the null left child of node 11 includes only one vertical node, whereas the paths to any other null node in the tree include two such links. One way to avoid the problem is to assure that when searching for the successor of a particular node, tree transformations are executed that make a vh-tree a valid vh-tree and cause the successor with no descendants to be connected to its parent with a horizontal link. To that end, a number of cases are distinguished with

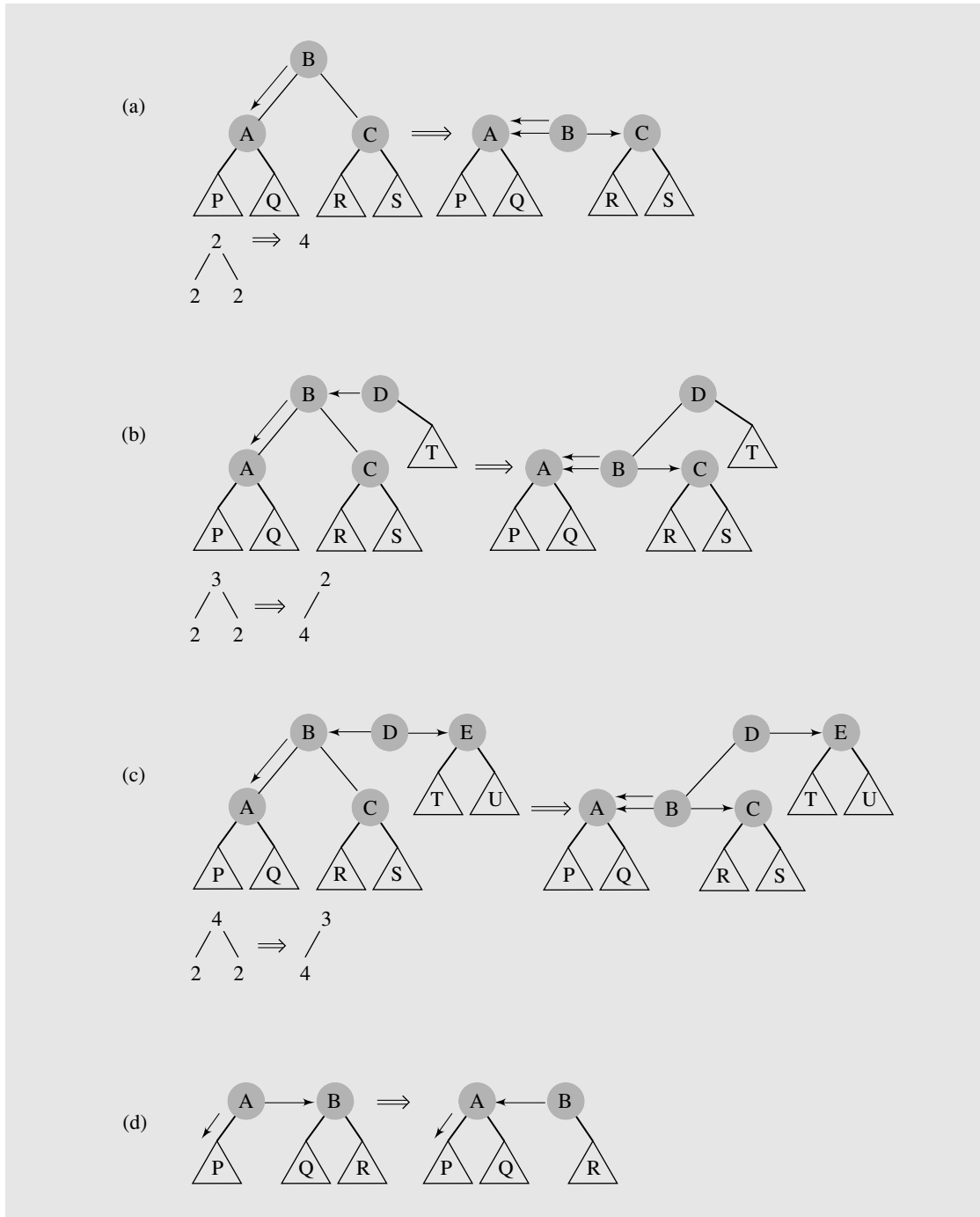
**FIGURE 7.28** Building a vh-tree by inserting numbers in this sequence: 10, 11, 12, 13, 4, 5, 8, 9, 6, 14.



transformations corresponding to them. Figure 7.29 illustrates these cases and shows an arrow next to a link to indicate the currently scrutinized node and the next node to be checked afterwards.

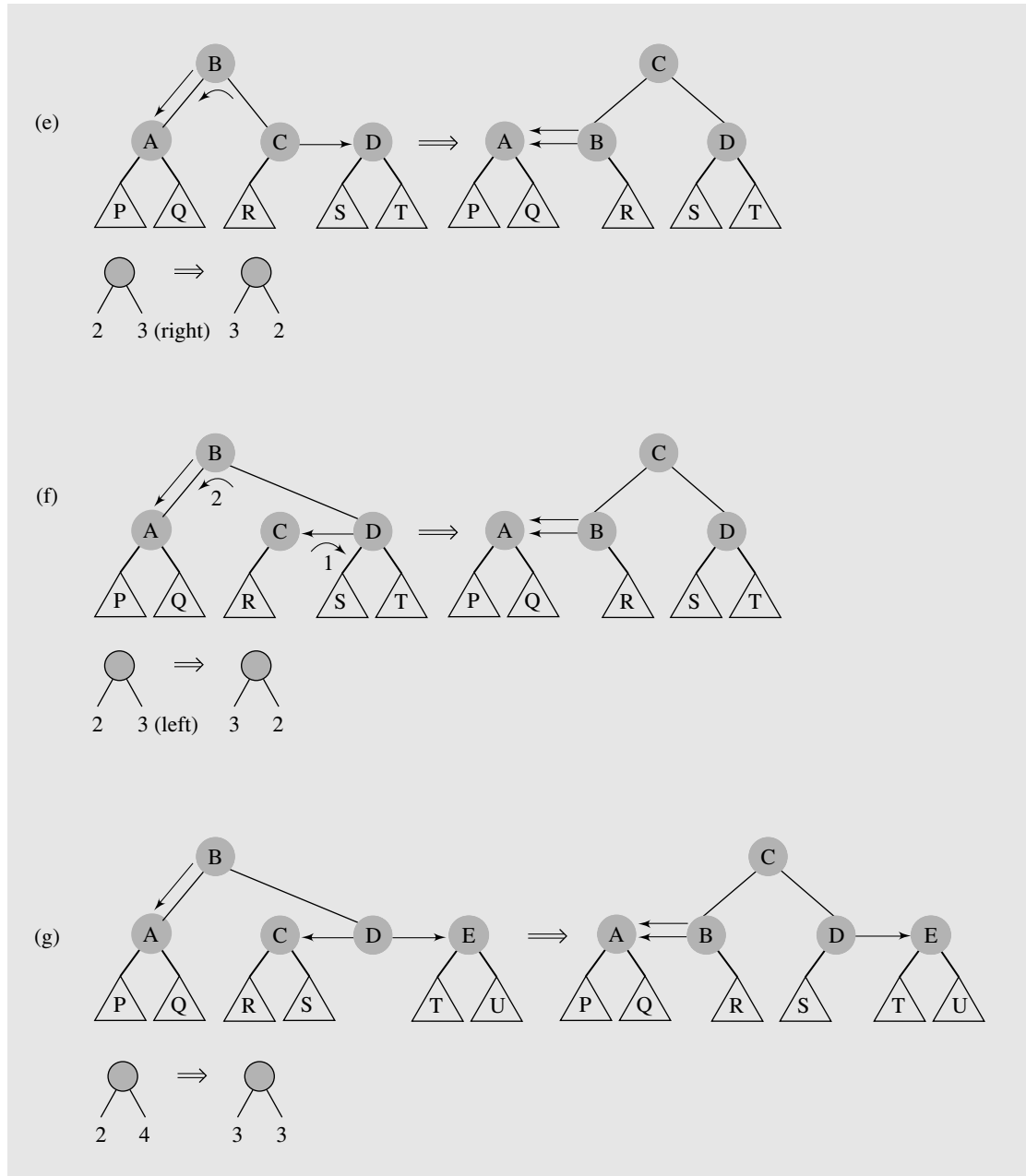
- **Case 1.** Two 2-node siblings have a 2-node parent; the node and its descendants are merged into a 4-node (Figure 7.29a), which requires only two flag changes.
- **Case 2.** A 3-node with two 2-node descendants is transformed by splitting the 3-node into two 2-nodes and creating a 4-node from the three 2-nodes, as indicated in Figure 7.29b, at the cost of three flag changes.
- **Case 2a.** A 4-node with two 2-node descendants is split into a 2-node and a 3-node, and the three 2-nodes are merged into a 4-node (Figure 7.29c). This requires the same three flag changes as in Case 2.
- **Case 3.** When the end of a 3-node with an out-horizontal link is reached, the direction of the link is reversed through one rotation and two flag changes (Figure 7.29d).

**FIGURE 7.29** Deleting a node from a vh-tree.



*Continues*

FIGURE 7.29 (continued)



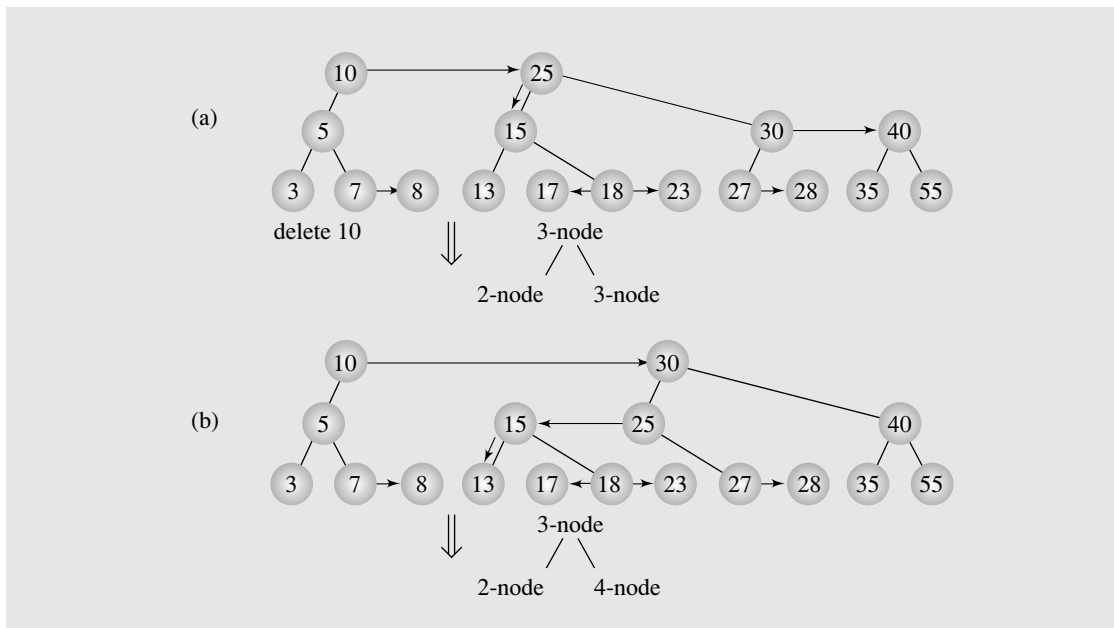


- **Case 4.** A 2-node has a 3-node sibling (there can be any sized parent). Through one rotation—*C* about *B*—and two flag changes, the 2-node is expanded into a 3-node and the 3-node sibling is reduced to a 2-node (Figure 7.29e).
- **Case 5.** Similar to Case 4, except that the 3-node sibling has a different direction. The transformation is accomplished through two rotations—first, *C* about *D* and then *C* about *B*—and two flag changes (Figure 7.29f).
- **Case 5a.** A 2-node has a 4-node sibling (any parent). The 2-node is changed into a 3-node and the 4-node is turned into a 3-node with the same transformations as in Case 5 (Figure 7.29g).

Note that in all these cases we are concerned about changing the link that leads to a 2-node from vertical to horizontal (except Case 3, where the change is inside a 3-node). Nothing is done when the destination is a 3- or 4-node.

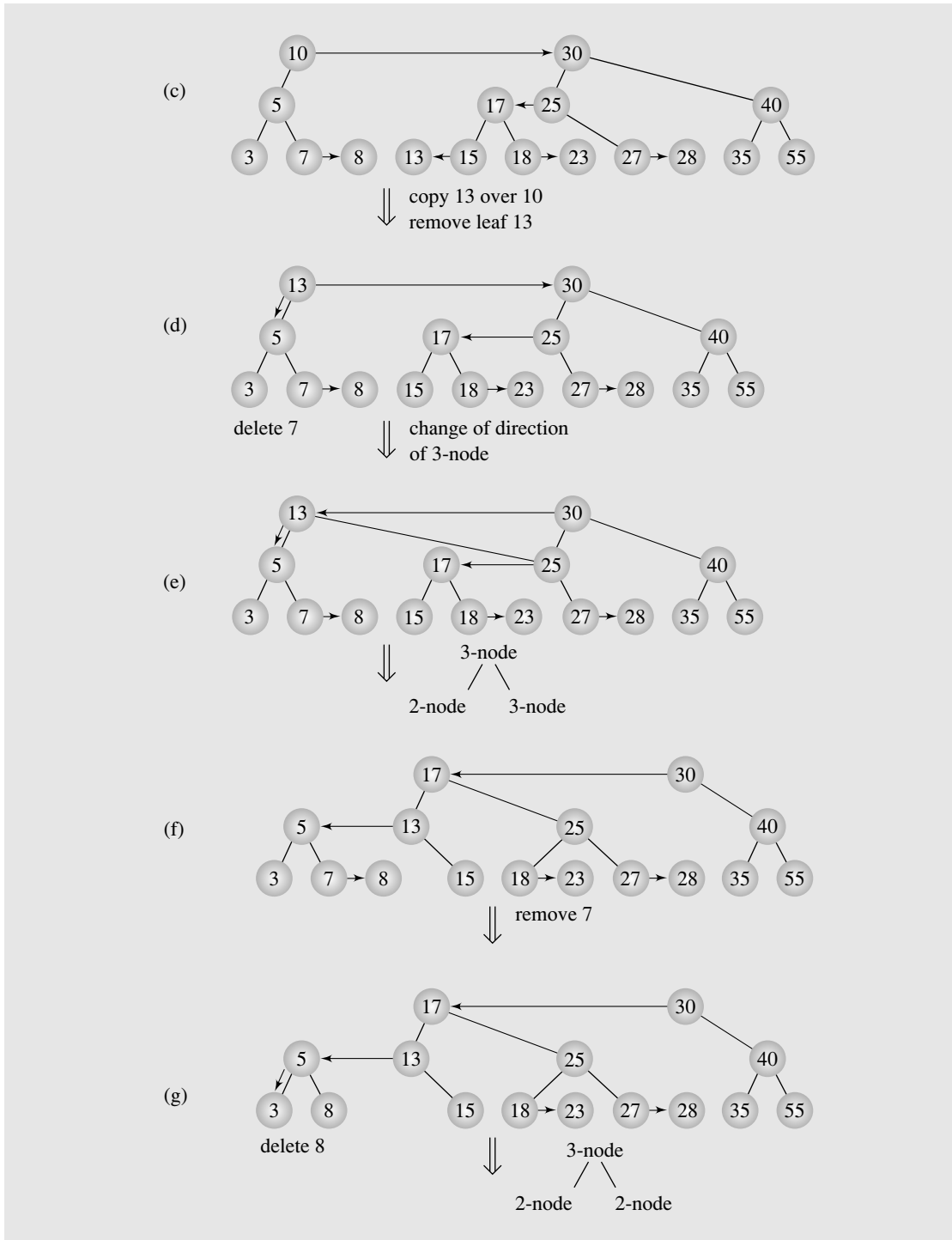
Required transformations are performed from the root until the successor of the node to be deleted is found. Because the node to be deleted must be found first, symmetrical cases to the cases already listed have to be included as well, so all in all, there are 15 cases: 1 requires no action, and the remaining 14 cases can be served with 10 different transformations. Examples of deletions are presented in Figure 7.30.

**FIGURE 7.30** Examples of node deletions from a vh-tree.

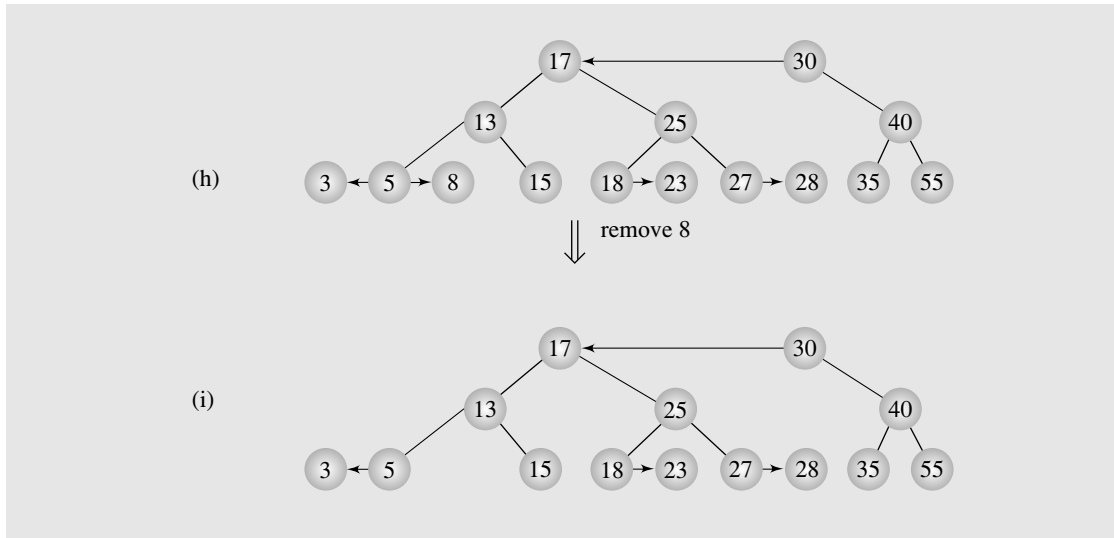


*Continues*

FIGURE 7.30 (continued)

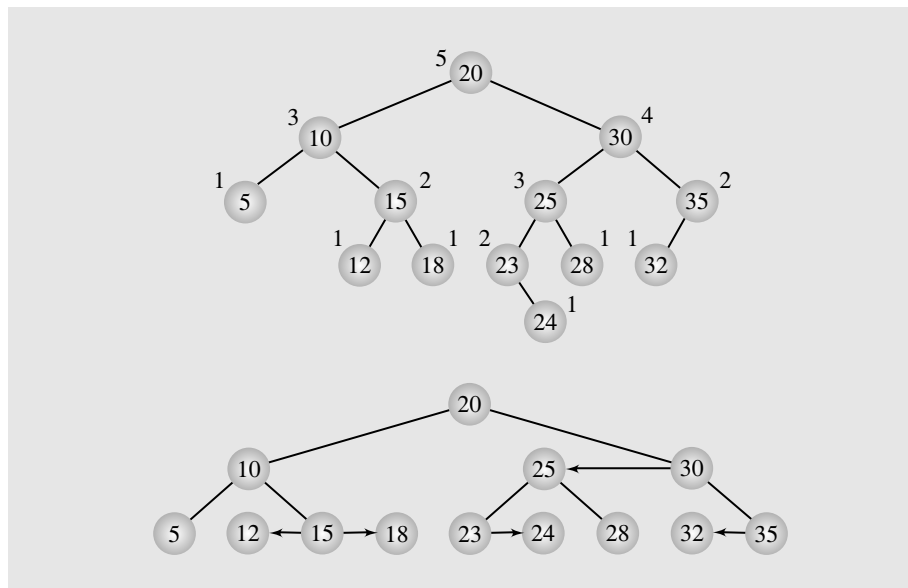


**FIGURE 7.30** (continued)



The vh-trees also include AVL trees. An AVL tree can be transformed into a vh-tree by converting the links connecting the roots of subtrees of even height with children of these roots of odd height into horizontal links. Figure 7.31 illustrates this conversion.

**FIGURE 7.31** An example of converting (a) an AVL tree into (b) an equivalent vh-tree.



### 7.1.8 Trees in `java.util`

#### `TreeSet`

A set is an object that stores unique elements. In Java, two implementations are available. The class `HashSet` implements the set with a hash table and a hash function (see Section 10.6.2). Another implementation is provided in the class `TreeSet`, which keeps elements of a set in a sorted order. Methods of `TreeSet` are listed in Figure 7.32. Most of the methods have already been encountered in classes `Vector` and `LinkedList`. However, because of the need for constant checking during insertion to determine whether an element being inserted is already in the set, the insertion operation has to be implemented specifically for that task. Although an array list could be a possible implementation of a set, the insertion operation requires  $O(n)$  time to finish. For an unordered array list, all the elements of the array list have to be tested before an insertion takes place. For an ordered array list, checking whether an element is in the array list takes  $O(\lg n)$  time with binary search, but an insertion of a new element requires shifting all greater elements so that the new element can be placed in a proper cell of the array list, and the complexity of this operation in the worst case is  $O(n)$ . To speed up execution of insertion (and also deletion), `TreeSet` uses a red-black tree for implementation of a set. This guarantees  $O(\lg n)$  time for insertion and deletion.

**FIGURE 7.32** Methods of the class `TreeSet`.

Method	Operation
<code>void add(Object e1)</code>	Insert object <code>e1</code> into the tree set if it is not already there; throw <code>ClassCastException</code> if <code>e1</code> cannot be compared with the elements currently in the tree set.
<code>boolean addAll(Collection c)</code>	Add all the elements from the collection <code>c</code> to the tree set; return <code>true</code> if the tree set was modified; throw <code>ClassCastException</code> if the elements in <code>c</code> are not comparable with elements in this tree set and <code>NullPointerException</code> if <code>c</code> is null.
<code>void clear()</code>	Remove all the elements from the tree set.
<code>Object clone()</code>	Return the copy of the tree set without cloning its elements.
<code>Comparator comparator()</code>	Return the comparator used to order the tree set or <code>null</code> if the <code>compareTo()</code> method is defined for the elements of the tree set.
<code>boolean contains(Object e1)</code>	Return <code>true</code> if the tree set contains the object <code>e1</code> ; throw <code>ClassCastException</code> if <code>e1</code> cannot be compared with the elements currently in the tree set.
<code>boolean containsAll(Collection c)</code>	Return <code>true</code> if the tree set contains all elements in the collection <code>c</code> ; throw <code>ClassCastException</code> if the class type of any element of <code>c</code> is incompatible with this tree set and <code>NullPointerException</code> if <code>c</code> is null (inherited).

**FIGURE 7.32** (continued)

<code>boolean equals(Object e1)</code>	Return <code>true</code> if the current tree set and object <code>e1</code> are equal (inherited).
<code>Object first()</code>	Return the smallest element of the tree set; throw <code>NoSuchElementException</code> if this tree set is empty.
<code>int hashCode()</code>	Return the hash code for the tree set (inherited).
<code>SortedSet headSet(Object e1)</code>	Return the subset with elements that precede <code>e1</code> ; throw <code>NullPointerException</code> if <code>e1</code> is null and this tree set uses elements' <code>compareTo()</code> method, or its comparator does not handle null elements; throw <code>ClassCastException</code> if <code>e1</code> is not comparable with the elements in this tree set; throw <code>IllegalArgumentException</code> if this tree set is a subtree set of another tree set and <code>e1</code> is not within the specified range of this tree set.
<code>boolean isEmpty()</code>	Return <code>true</code> if the tree set contains no elements, <code>false</code> otherwise.
<code>Iterator iterator()</code>	Generate and return an iterator for the tree set.
<code>Object last()</code>	Return the largest element of the tree set; throw <code>NoSuchElementException</code> if this tree set is empty.
<code>boolean remove(Object e1)</code>	Remove the object <code>e1</code> from the tree set and return <code>true</code> if <code>e1</code> was in the tree set; throw <code>ClassCastException</code> if <code>e1</code> cannot be compared with the elements currently in the tree set.
<code>boolean removeAll(Collection c)</code>	Remove from the tree set all elements contained in collection <code>c</code> ; return <code>true</code> if any element was removed; throw <code>ClassCastException</code> if the class type of any element of <code>c</code> is incompatible with this tree set and <code>NullPointerException</code> if <code>c</code> is null (inherited).
<code>boolean retainAll(Collection c)</code>	Remove from the tree set all elements that are not in the collection <code>c</code> ; return <code>true</code> if any element was removed; throw <code>ClassCastException</code> if the class type of any element of <code>c</code> is incompatible with this tree set and <code>NullPointerException</code> if <code>c</code> is null (inherited).
<code>int size()</code>	Return the number of elements in the tree set.
<code>SortedSet subSet(Object first, Object last)</code>	Return the subset of the tree set (not its copy) containing elements between <code>first</code> and <code>last</code> , including <code>first</code> ; throw <code>NullPointerException</code> if <code>first</code> or <code>last</code> is null and this tree set uses keys' <code>compareTo()</code> method, or its comparator does not handle null elements; throw <code>ClassCastException</code> if <code>first</code> or <code>last</code> is not comparable with the elements in this tree set; throw <code>IllegalArgumentException</code> if <code>first</code> precedes <code>last</code> .

*Continues*

**FIGURE 7.32** (continued)

<code>SortedSet tailSet(Object e1)</code>	Return the subset with elements that are equal to or exceed <code>e1</code> ; throw <code>NullPointerException</code> if <code>e1</code> is null and this tree set uses elements' <code>compareTo()</code> method, or its comparator does not handle null elements; throw <code>ClassCastException</code> if <code>e1</code> is not comparable with the elements in this tree set; throw <code>IllegalArgumentException</code> if this tree set is a subtree set of another tree set and <code>e1</code> is not within the specified range of this tree set.
<code>Object[] toArray()</code>	Copy all elements from the tree set to a newly created array and return the array (inherited).
<code>Object[] toArray(Object a[])</code>	Copy all elements from the tree set to the array <code>a</code> if <code>a</code> is large enough or to a newly created array and return the array; throw <code>ArrayStoreException</code> if the class type of any element in the tree set is not the same as or does not extend the class type of <code>a</code> ; throw <code>NullPointerException</code> if <code>a</code> is null (inherited).
<code>String toString()</code>	Return a string representation of the tree set that contains the string representation of all the elements (inherited).
<code>TreeSet()</code>	Create an empty tree set for elements that implement <code>Comparable</code> .
<code>TreeSet(Collection c)</code>	Create a tree set with copies of elements from collection <code>c</code> sorted according to the method <code>compareTo()</code> ; throw <code>ClassCastException</code> if the elements in <code>c</code> do not implement <code>Comparable</code> or are not mutually comparable and <code>NullPointerException</code> if <code>c</code> is null.
<code>TreeSet(Comparator c)</code>	Create an empty tree set sorted according to the comparator <code>c</code> .
<code>TreeSet(SortedSet s)</code>	Create a tree set with copies of elements from sorted set <code>s</code> using <code>s</code> 's ordering; throw <code>NullPointerException</code> if <code>s</code> is null.

Class hierarchy in `java.util` is as follows

`Object` ⇒ `AbstractCollection` ⇒ `AbstractSet` ⇒ `TreeSet`

The operation of some methods for integer sets is illustrated in Figure 7.33.

A new number is inserted into a tree set if it is not already there. For example, an attempt to insert number 5 into `st1 = (4 5 6)` is unsuccessful.

A more interesting situation arises for compound objects whose order is determined by the values of some of its fields. Consider the class `Person` defined in Figure 7.33. Any attempt to add a new object of type `Person` raises the `ClassCastException`. Because `TreeSet` is an ordered structure, an ordering relation must be provided to determine the order of elements in the tree set. For simple objects, such as objects of type

**FIGURE 7.33** An example of application of the `TreeSet` methods.

```

import java.io.*;
import java.util.TreeSet;

class Person {
    protected String name;
    protected int age;
    public Person(String s, int i) {
        name = s; age = i;
    }
    public Person() {
        this("",0);
    }
    public String toString() {
        return "(" + name + ", " + age + ")";
    }
}

class PersonByName extends Person implements Comparable {
    public PersonByName(String s, int i) {
        super(s,i);
    }
    public PersonByName() {
        super();
    }
    public PersonByName(Person p) {
        super(p.name,p.age);
    }
    public int compareTo(Object p) {
        return name.compareTo(((Person)p).name);
    }
}

class PersonByAge extends Person implements Comparable {
    public PersonByAge(String s, int i) {
        super(s,i);
    }
    public PersonByAge() {
        super();
    }
    public PersonByAge(Person p) {
        super(p.name,p.age);
    }
}

```

*Continues*

**FIGURE 7.33** (continued)

```

    public int compareTo(Object p) {
        return age - ((Person)p).age;
    }
}

class PersonComparator implements java.util.Comparator {
    public int compare(Object ob1, Object ob2) {
        if (ob1 == ob2)
            return 0;
        else if (ob1 == null)
            return -1;
        else if (ob2 == null)
            return 1;
        else return ((Person)ob1).name.compareTo(((Person)ob2).name);
    }
}

class TestTreeSet {
    public static void main(String[] ar) {
        TreeSet set1 = new TreeSet();           // set1 = []
        set1.add(new Integer(4));               // set1 = [4]
        set1.add(new Integer(5));               // set1 = [4, 5]
        set1.add(new Integer(6));               // set1 = [4, 5, 6]
        set1.add(new Integer(5));               // set1 = [4, 5, 6]
        System.out.println("set1 = " + set1);   // set1 = [4, 5, 6]
        System.out.println(set1.contains(new Integer(5))); // true
        System.out.println(set1.contains(new Integer(7))); // false
        System.out.println(set1.first() + " " + set1.last()); // 4 6
        System.out.println(set1.headSet(new Integer(5))); // [4]
        System.out.println(set1.tailSet(new Integer(5))); // [5, 6]
        TreeSet set2 = new TreeSet(set1);      // set2 = [4, 5, 6]
        set2.remove(new Integer(5));            // set2 = [4, 6]
        set1.removeAll(set2);                   // set1 = [5]
        set1.addAll(set2);                       // set1 = [4, 5, 6]

        TreeSet pSet1 = new TreeSet(), pSet2 = new TreeSet();
        Person[] p = {new Person("Gregg",25), new Person("Ann",30),
                     new Person("Bill",20), new Person("Gregg",35),
                     new Person("Kay",30)};
        for (int i = 0; i < p.length; i++)
            pSet1.add(new PersonByName(p[i]));
    }
}

```



**FIGURE 7.33** (continued)

```

// pSet1 = [(Ann,30), (Bill,20), (Gregg,25), (Kay,30)]
for (int i = 0; i < p.length; i++)
    pSet2.add(new PersonByAge(p[i]));
// pSet2 = [(Bill,20), (Gregg,25), (Ann,30), (Gregg,35)]
java.util.Iterator it = pSet2.iterator();
it.next();
((Person)it.next()).age = 50;
// pSet2 = [(Bill,20), (Gregg,50), (Ann,30), (Gregg,35)]
pSet2.add(new PersonByAge("Craig",40));
// pSet2 = [(Bill,20), (Craig,40), (Gregg,50), (Ann,30), (Gregg,35)]
for (int i = 0; i < p.length; i++)
    System.out.println(p[i] + " "
        + pSet2.contains(new PersonByAge(p[i])));

// (Gregg,25) false
// (Ann,30) false
// (Bill,20) true
// (Gregg,35) false
// (Kay,30) false
TreeSet pSet3 = new TreeSet(new PersonComparator());
for (int i = 0; i < p.length; i++)
    pSet3.add(p[i]);
pSet3.add(null);
pSet3.add(null);
System.out.println("pSet3 = " + pSet3);
// pSet3 = [null, (Ann,30), (Bill,20), (Gregg,25), (Kay,30)]
}
}

```

Integer, the relation is already provided by the system, but for user-defined classes the relation has to be also user-defined.

For the class `Person`, which contains two fields—a string field `name` and an integer field `age`—the order of objects can be determined by the first field, by the second, or by both. For the sake of example, two classes are derived from `Person`—`PersonByName` and `PersonByAge`—which inherit the same data fields from `Person` but define the ordering relation differently. The definition is accomplished by defining the method `compareTo()` from interface `Comparable`. For this reason, both `PersonByName` and `PersonByAge` are declared as implementations of `Comparable`. Now, two tree sets are created, `pSet1` with person objects ordered by name and `pSet2` with objects ordered by age. For this reason, each name appears in `pSet1` only once so that the object (“Gregg,”35) from the array `p[]` is not

included, whereas in `pSet2` each age is unique, so that object (“Kay,”30) is not included.

It is very important that operations on the objects in the tree set do not disturb the order of these elements in the tree set because it may adversely affect subsequent operations. For example, after changing the age of Gregg in `pSet1` to 50, the object (“Craig,”40) is included in front of the updated object (“Gregg,”50). Moreover, searching may result in incorrect results. For all the objects from the array `p[ ]`, only the one preceding the updated object is found. The remaining objects are considered absent from `pSet1`. The reason is the tree implementation of the set. For each node of the tree, the search decides whether to continue searching for a particular key in the left subtree or in the right subtree. After the key in the node is increased, the search is sometimes directed to the left subtree, although before modification of the node, it would be directed to the right subtree.

Another concern is the inclusion of a null object in the tree set. An attempt to include a null object in `pSet1` or `pSet2` results in the `NullPointerException`. The reason is the syntax of the `compareTo()` method, which is `ob1.compareTo(ob2)`. If `ob1` is null, then the program crashes. To circumvent the problem, comparison must be introduced not as redefinition of `compareTo()` from `Comparable`, but as redefinition of `compare()` from class `Comparator`. The method `compareTo()` is redefined inside of a class that is used to generate objects. The method `compare()` is redefined outside of a class that is used to generate objects and inside a comparator class that implements the interface `Comparator`. In Figure 7.33, `PersonComparator` is defined to compare objects of type `Person`. To let the system know that `compare()` should be used instead of `compareTo()`, a new tree set is declared with the constructor `TreeSet(comp)`, where `comp` is a comparator (see the declaration of `pSet3`), not with `TreeSet()` as in the case of `pSet1` and `pSet2`.

### TreeMap

Maps are tables that can be indexed with any type of data. Hence, they are a generalization of arrays because arrays can be indexed only with constants and variables of ordinal types, such as characters and nonnegative integers, but not with strings or double numbers.

Maps use keys that are used as indexes and elements (values) to be accessed through the keys. Like indexes in arrays, keys in maps are unique in that one key is associated with one value only. Thus, maps are also a generalization of sets. Like sets, maps are implemented as red-black trees. But unlike tree sets implementing sets that store keys only, tree maps implementing maps store pairs (key, value) called entries that can be operated on by methods specified in the interface `Map.Entry` whose declaration is nested in the body of the interface `Map` (Figure 7.34a). The pairs are ordered by an ordering relation defined for keys, not for values. Therefore, a particular value is found in the tree map by locating a particular node using the key that is associated with this value and extracting the value from this node. Values can be modified without disturbing the order in the tree map, because the tree map, is ordered by keys, not values, which also means that keys in the tree map cannot be modified.

**FIGURE 7.34** (a) Methods in the interface `Map.Entry`; (b) methods of the class `TreeMap`.

(a) Method	Operation
<code>boolean equals(Object ob)</code>	Return <code>true</code> if the map entry equals <code>ob</code> .
<code>Object getKey()</code>	Return the key of the map entry.
<code>Object getValue()</code>	Return the value of the map entry.
<code>int hashCode()</code>	Return the hash code for the map entry.
<code>Object setValue(Object val)</code>	Replace the value of the map entry by <code>val</code> and return the old value; throw <code>UnsupportedOperationException</code> if the put operation is not defined by the underlying map <code>m</code> ; throw <code>ClassCastException</code> if the class of <code>val</code> prevents it from being stored in <code>m</code> ; throw <code>IllegalArgumentException</code> if some aspect of <code>val</code> prevents it from being stored in <code>m</code> ; throw <code>NullPointerException</code> if <code>val</code> is null and null values cannot be stored in <code>m</code> .
(b) Method	Operation
<code>void clear()</code>	Remove all the objects from the tree map.
<code>Object clone()</code>	Return the copy of the tree map without cloning its elements.
<code>Comparator comparator()</code>	Return the comparator used to order the tree map or null if the <code>compareTo()</code> method is defined for the keys of the tree map.
<code>boolean containsKey(Object key)</code>	Return <code>true</code> if the tree map contains the object <code>key</code> ; throw <code>NullPointerException</code> if <code>key</code> is null and this tree map uses keys' <code>compareTo()</code> method or its comparator does not handle null keys; throw <code>ClassCastException</code> if <code>key</code> is not comparable with the keys in this tree map.
<code>boolean containsValue(Object val)</code>	Return <code>true</code> if the tree map contains the object <code>val</code> .
<code>Set entrySet()</code>	Return a set containing all the pairs (key, value) in the tree map.
<code>boolean equals(Object ob)</code>	Return <code>true</code> if the current tree map and object <code>ob</code> are equal (inherited).
<code>Object firstKey()</code>	Return the smallest key of the tree map; throw <code>NoSuchElementException</code> if the tree map is empty.
<code>Object get(Object key)</code>	Return the object associated with <code>key</code> ; throw <code>NullPointerException</code> if <code>key</code> is null and this tree map uses keys' <code>compareTo()</code> method, or its comparator does not handle null keys; throw <code>ClassCastException</code> if <code>key</code> is not comparable with the keys in this tree map.

*Continues*

**FIGURE 7.34** (continued)

<code>int hashCode()</code>	Return the hash code for the tree map (inherited).
<code>SortedMap headMap(Object key)</code>	Return the submap with objects associated with keys that precede <code>key</code> ; throw <code>NullPointerException</code> if <code>key</code> is null and this tree map uses keys' <code>compareTo()</code> method, or its comparator does not handle null keys; throw <code>ClassCastException</code> if <code>key</code> is not comparable with the keys in this tree map; throw <code>IllegalArgumentException</code> if this tree map is a subtree map of another tree map and <code>key</code> is not within the specified range of this tree map.
<code>boolean isEmpty()</code>	Return <code>true</code> if the tree map contains no elements, <code>false</code> otherwise (inherited).
<code>Set keySet()</code>	Return a set containing all the keys of the tree map.
<code>Object lastKey()</code>	Return the largest object of the tree map; throw <code>NoSuchElementException</code> if the tree map is empty.
<code>Object put(Object key, Object value)</code>	Put the pair ( <code>key, value</code> ) in the tree map; return a value associated with <code>key</code> if there is any in the tree map, <code>null</code> otherwise; throw <code>NullPointerException</code> if <code>key</code> is null and this tree map uses keys' <code>compareTo()</code> method, or its comparator does not handle null keys; throw <code>ClassCastException</code> if <code>key</code> is not comparable with the keys in this tree map.
<code>void putAll(Map m)</code>	Add objects from the map <code>m</code> to the current tree map; throw <code>ClassCastException</code> if class of a key or value in <code>m</code> does not allow it to be stored in this tree map and <code>NullPointerException</code> if <code>m</code> is null or a key in <code>m</code> is null, but this tree map does not permit null keys.
<code>Object remove(Object key)</code>	Remove the pair ( <code>key,value</code> ) from the tree map and return the value associated currently with <code>key</code> in the tree map or <code>null</code> otherwise; throw <code>NullPointerException</code> if <code>key</code> is null and this tree map uses keys' <code>compareTo()</code> method, or its comparator does not handle null keys; throw <code>ClassCastException</code> if <code>key</code> is not comparable with the keys in this tree map.
<code>int size()</code>	Return the number of objects in the tree map.
<code>SortedMap subMap(Object first, Object last)</code>	Return the submap of the tree map (not its copy) containing elements with keys between <code>first</code> and <code>last</code> , including <code>first</code> ; throw <code>NullPointerException</code> if <code>first</code> or <code>last</code> is null and this tree map uses keys' <code>compareTo()</code> method, or its comparator does not handle null keys; throw <code>ClassCastException</code> if <code>first</code> or <code>last</code> is not comparable with the keys in this tree map; throw <code>IllegalArgumentException</code> if <code>first</code> precedes <code>last</code> .

**FIGURE 7.34** (continued)

<code>SortedMap tailMap(Object key)</code>	Return the submap with objects associated with keys not smaller than <code>key</code> ; throw <code>NullPointerException</code> if <code>key</code> is null and this tree map uses keys' <code>compareTo()</code> method, or its comparator does not handle null keys; throw <code>ClassCastException</code> if <code>key</code> is not comparable with the keys in this tree map; throw <code>IllegalArgumentException</code> if this tree map is a subtree map of another tree map and <code>key</code> is not within the specified range of this tree map.
<code>String toString()</code>	Return a string representation of the tree map that contains the string representation of all the objects (inherited).
<code>TreeMap()</code>	Create an empty tree map for elements with keys that implement <code>Comparable</code> .
<code>TreeMap(Map m)</code>	Create a tree map with copies of elements from map <code>m</code> sorted according to keys' <code>compareTo()</code> method; throw <code>ClassCastException</code> if the keys in <code>m</code> do not implement <code>Comparable</code> or are not mutually comparable; throw <code>NullPointerException</code> if <code>m</code> is null.
<code>TreeMap(Comparator c)</code>	Create an empty tree map sorted according to the comparator <code>c</code> .
<code>TreeMap(SortedMap m)</code>	Create a tree map with copies of elements from sorted map <code>m</code> using <code>m</code> 's ordering; throw <code>NullPointerException</code> if <code>m</code> is null.
<code>Collection values()</code>	Return a collection with all the values contained in the tree map.

Methods of the class `TreeMap` are listed in Figure 7.34b. Class hierarchy in `java.util` is as follows

`Object`  $\Rightarrow$  `AbstractMap`  $\Rightarrow$  `TreeMap`

Operation of some methods is illustrated in Figure 7.35. The tree map `cities` is indexed with objects of type `Person`. The tree map is initialized with three pairs (`Person` object, string). The statement

```
cities.put(new PersonByName("Gregg",30), "Austin");
```

uses a new object as an index. Note that the object has a different value in the `age` field than the existing entry for `Gregg` in the tree map, but both the object `PersonByName("Gregg",25)` in the tree map and the object `PersonByName("Gregg",30)` are treated as equal because the definition of `compareTo()` in the definition of class `PersonByName` takes only the `name` field into account; therefore, the old value, "Pittsburgh", is replaced by a new value, "Austin".

**FIGURE 7.35** An example of application of the `TreeMap` methods. The class `PersonByName` is the same as in Figure 7.33.

```

class TestTreeMap
{
    public static void main(String[] a) {
        TreeMap cities = new TreeMap();
        cities.put(new PersonByName("Gregg",25),"Pittsburgh");
        cities.put(new PersonByName("Ann",30),"Boston");
        cities.put(new PersonByName("Bill",20),"Belmont");
        System.out.println(cities);
        // {(Ann,30)=Boston, (Bill,20)=Belmont, (Gregg,25)=Pittsburgh}
        cities.put(new PersonByName("Gregg",30),"Austin");
        // cities = {(Ann,30)=Boston, (Bill,20)=Belmont, (Gregg,25)=Austin}
        System.out.println(cities.containsKey(new PersonByName("Ann",30)));
        // true
        System.out.println(cities.containsValue("Austin"));
        // true
        System.out.println(cities.firstKey() + " " + cities.lastKey());
        // (Ann,30) (Gregg,25)
        System.out.println(cities.get(new PersonByName("Ann",30)));
        // Boston
        System.out.println(cities.entrySet());
        // [(Ann,30)=Boston, (Bill,20)=Belmont, (Gregg,25)=Austin]
        System.out.println(cities.keySet());
        // [(Ann,30), (Bill,20), (Gregg,25)]
        System.out.println(cities.remove(new PersonByName("Bill",20)));
        // Belmont
        // cities = {(Ann,30)=Boston, (Gregg,25)=Austin}

        Map.Entry me = (Map.Entry)cities.entrySet().iterator().next();
        // first entry
        System.out.println(me.getKey());           // (Ann,30)
        System.out.println(me.getValue());        // Boston
        System.out.println(me.setValue("Harrisburg")); // Boston
        System.out.println(cities);
        // cities = {(Ann,30)=Harrisburg, (Gregg,25)=Austin}
    }
}

```

The program in Figure 7.35 illustrates the way the methods specified in the interface `Map.Entry` can be used. The set of entries of the underlying tree map can be created with the `entrySet()` method and then the `Map.Entry` methods can be applied individually to the desired entries. Note that updating the entry set returned by the `entrySet()` method affects the tree map itself.

The program in Figure 7.35 is shown only to illustrate unconventional indexing. For this particular example, it would probably be more natural to include a city as another data member in each object. A more useful example concerns social security numbers and objects of type `PersonByName`. If we wanted to create an array (or a vector) so that SSNs could be used as indexes, the array would need 1 billion cells because the largest SSN equals 999999999. But with tree maps, we can have only as many entries as the number of `PersonByName` objects used in the program. For example, we can declare a map `SSN`

```
TreeMap SSN = new TreeMap();
```

and then execute a number of assignments

```
SSN.put(new Integer(123456789), new PersonByName("Gregg",25));
SSN.put(new Integer(111111111), new PersonByName("Ann",30));
SSN.put(new Integer(222222222), new PersonByName("Bill",20));
```

In this way, `SSN` has only three entries, although keys are very large numbers

```
SSN = {111111111= ("Ann",20), 123456789=("Gregg",25), 222222222=("Bill", 20)}
```

Information is now very easily accessible and modifiable by using SSNs as the access keys.

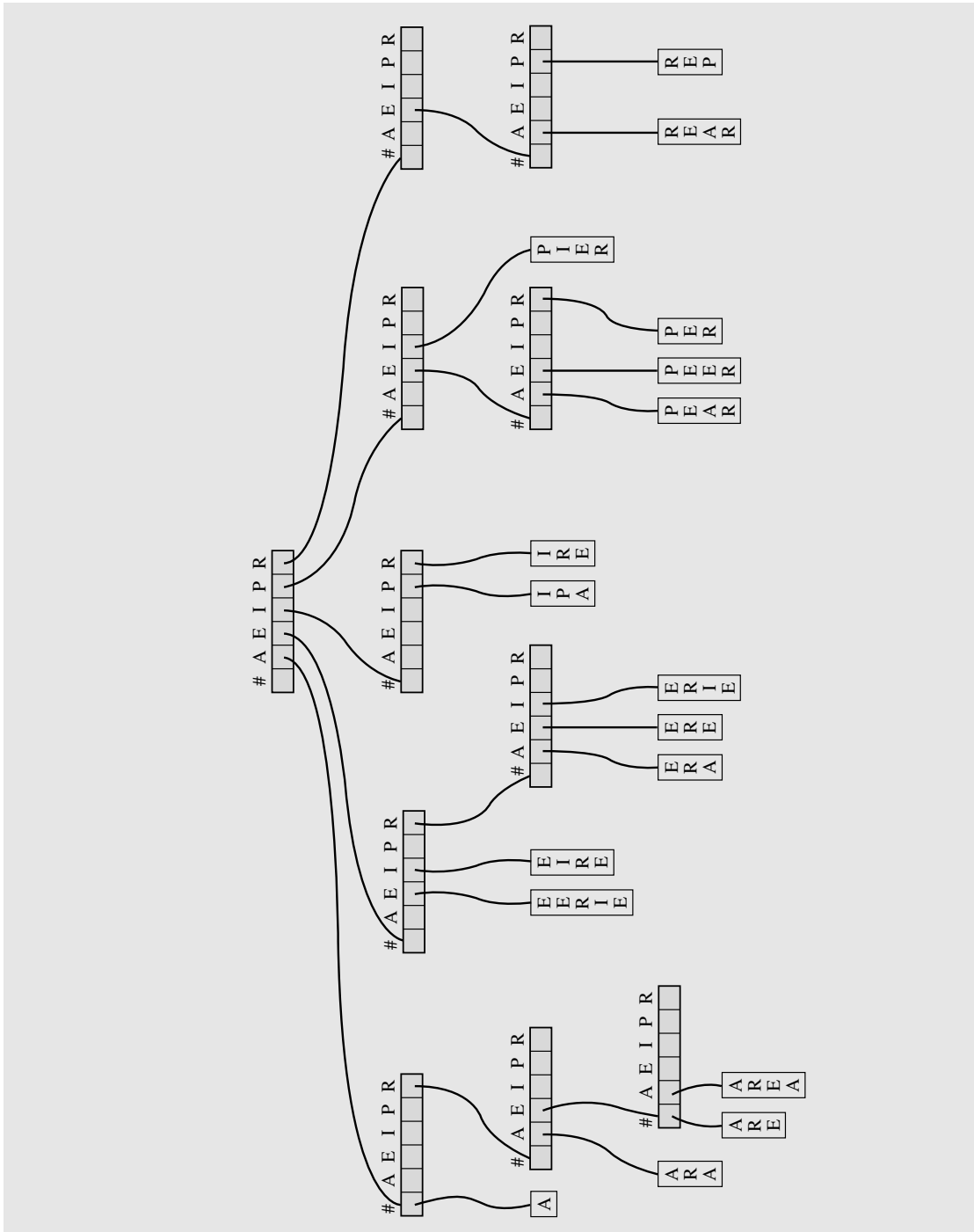
## 7.2 TRIES

The preceding chapter showed that traversing a binary tree was guided by full key comparisons; each node contained a key that was compared to another key to find a proper path through the tree. The discussion of prefix B-trees indicated that this is not necessary and that only a portion of a key is required to determine the path. However, finding a proper prefix became an issue, and maintaining prefixes of an acceptable form and size made the process for insertion and deletion more complicated than in standard B-trees. A tree that uses parts of the key to navigate the search is called a *trie*. The name of the tree is appropriate, as it is a portion of the word *retrieval* with convoluted pronunciation: To distinguish a tree from a trie in speech, trie is pronounced “try.”

Each key is a sequence of characters, and a trie is organized around these characters rather than entire keys. For simplicity, assume that all the keys are made out of five capital letters: A, E, I, P, R. Many words can be generated out of these five letters but our examples will use only a handful of them.

Figure 7.36 shows a trie for words that are indicated in the vertical rectangles; this form was first used by E. Fredkin. These rectangles represent the leaves of the trie, which are nodes with actual keys. The internal nodes can be viewed as arrays of

**FIGURE 7.36** A trie of some words composed of the five letters A, E, I, R, and P. The sharp sign, #, indicates the end of a word, which can be a prefix of another word.





references to subtries. At each level  $i$ , the position of the array that corresponds to the  $i$ th letter of the key being processed is checked. If the reference in this position is null, the key is not in the trie, which may mean a failure or a signal for key insertion. If not, we continue processing until a leaf containing this key is found. For example, we check for the word “ERIE.” At the first level of the trie, the reference corresponding to the first letter of this word, “E,” is checked. The reference is not null, so we go to the second level of the trie, to the child of the root accessible from position “E”; now the reference in the position indicated by the second letter, “R,” is tested. It is not null either, so we descend down the trie one more level. At the third level, the third letter, “I,” is used to access a reference in this node. The reference refers to a leaf containing the word “ERIE.” Thus, we conclude that the search is successful. If the desired word was “ERIIE,” we would fail because we would access the same leaf as before, and obviously, the two words are different. If the word were “ERPIE,” we would access the same node with a leaf that contains “ERIE,” but this time “P” would be used to check the corresponding reference in the node. Because the reference is null, we would conclude that “ERPIE” is not in the trie.

There are at least two problems. First, how do we make a distinction between two words when one is a prefix of the other? For example, “ARE” is a prefix in “AREA.” Thus, if we are looking for “ARE” in the trie, we must not follow the path leading to “AREA.” To that end, a special character is used in each node guaranteed not to be used in any word, in this case, a sharp sign, “#.” Now, while searching for “ARE” and after processing “A,” “R,” and “E,” we find ourselves in a node at the fourth level of the trie, whose leaves are “ARE” and “AREA.” Because we processed all letters of the key “ARE,” we check the reference corresponding to the end of words, “#,” and because it is not empty, we conclude that the word is in the trie.

This last example points to another problem. Is it really necessary to store entire words in the trie? After we reached the fourth level when searching for “ARE” and the reference for “#” is not null, do we have to go to the leaf to make a comparison between the key “ARE” and the contents of the leaf, also “ARE”? Not necessarily, and the example of prefix B-trees suggests the solution. The leaves may contain only the unprocessed suffixes of the words.

This example restricted the number of letters used to five, but in a more realistic setting, all letters are used so that each node has 27 references (including “#”). The height of the trie is determined by the longest prefix, and for English words, the prefix should not be a long string. For most words, the matter is settled after several node visits, probably 5–7. This is true for 10,000 English words in the trie, and for 100,000. A corresponding perfectly balanced binary search tree for 10,000 words has a height  $\lceil \lg 10,000 \rceil = 14$ . Most words are stored on the lowest levels of this tree, so on the average, the search takes 13 node visits. (The average path length in a perfectly balanced tree of height  $h$  is  $\lceil \lg h \rceil - 2$ .) This is double the number of visits in the trie. For 100,000 words, the average number of visits in the tree increases by 3 because  $\lceil \lg 100,000 \rceil = 17$ ; in the trie this number can increase by 1 or 2. Besides, when making a comparison in the binary search tree, the comparison is made between the key searched for and the key in the current node, whereas in the trie only one character is used in each comparison except when comparing with a key in a leaf. Therefore, in

situations where the speed of access is vital, such as in spell checkers, a trie is a very good choice.

Due to the fact that the trie has two types of nodes, inserting a key into a trie is a bit more complicated than inserting it into a binary search tree.

```

trieInsert(K)
  i = 0;
  p = the root;
  while not inserted
    if the end of word k is reached
      set the end-of-word marker in p to true;
    else if (p.ptrs[K[i]] == 0)
      create a leaf containing K and put its address in p.ptrs[K[i]];
    else if reference p.ptrs[K[i]] refers to a leaf
      K_L = key in leaf p.ptrs[K[i]]
      do create a nonleaf and put its address in p.ptrs[K[i]];
        p = the new nonleaf;
      while (K[i] == K_L[i++]);
      create a leaf containing K and put its address in p.ptrs[K[--i]];
      if the end of word k is reached
        set the end-of-word marker in p to true;
      else create a leaf containing K_L and put its address in p.ptrs[K_L[i]];
    else p = p.ptrs[K[i++]];

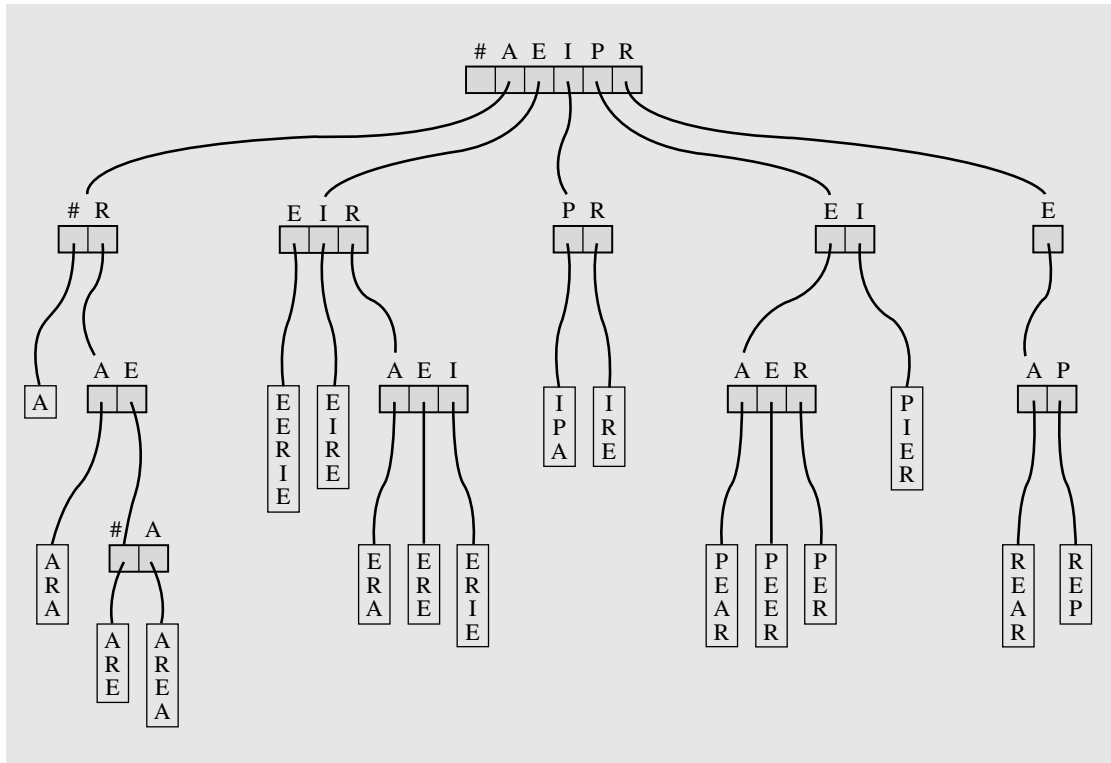
```

The inner do loop in this algorithm is needed when a prefix in the word  $k$  and in the word  $K_L$  is longer than the number of nodes in the path leading to the current node  $p$ . For example, before “REP” is inserted in the trie in Figure 7.36, the word “REAR” is stored in a leaf corresponding to the letter “R” of the root of the trie. If “REP” is now being inserted, it is not enough to replace this leaf by a nonleaf, because the second letters of both these words are the same letter, “E.” Hence, one more nonleaf has to be created on the third level of the trie, and two leaves containing the words “REAR” and “REP” are attached to this nonleaf.

If we compare tries with binary search trees, we see that for tries, the order in which keys are inserted is irrelevant, whereas this order determines the shape of binary search trees. However, tries can be skewed by words or, rather, by the type of prefixes in words being inserted. The length of the longest identical prefix in two words determines the height of the trie. Therefore, the height of the trie is equal to the length of the longest prefix common to two words plus one (for a level to discriminate between the words with this prefix) plus one (for the level of leaves). The trie in Figure 7.36 has height five because the longest identical prefix, “ARE,” is merely three letters long.

The main problem tries pose is the amount of space they require; a substantial amount of this space is basically wasted. Many nodes may have only a couple of nonnull references, and yet the remaining 25 references must reside in memory. There is a burning need to decrease the amount of required space.

One way to reduce the size of a node is by storing only those references that are actually in use, as in Figure 7.37 (Briandais, 1959). However, the introduced flexibility concerning the size of each node somewhat complicates the implementation. Such

**FIGURE 7.37** The trie in Figure 7.36 with all unused reference fields removed.

tries can be implemented in the spirit of 2–4 tree implementation. All sibling nodes can be put on a linked list accessible from the parent node, as in Figure 7.38. One node of the previous trie corresponds now to a linked list. This means that random access of references stored in arrays is no longer possible, and the linked lists have to be scanned sequentially, although not exhaustively, because alphabetical order is most likely maintained. The space requirements are not insignificant either because each node now contains two references.

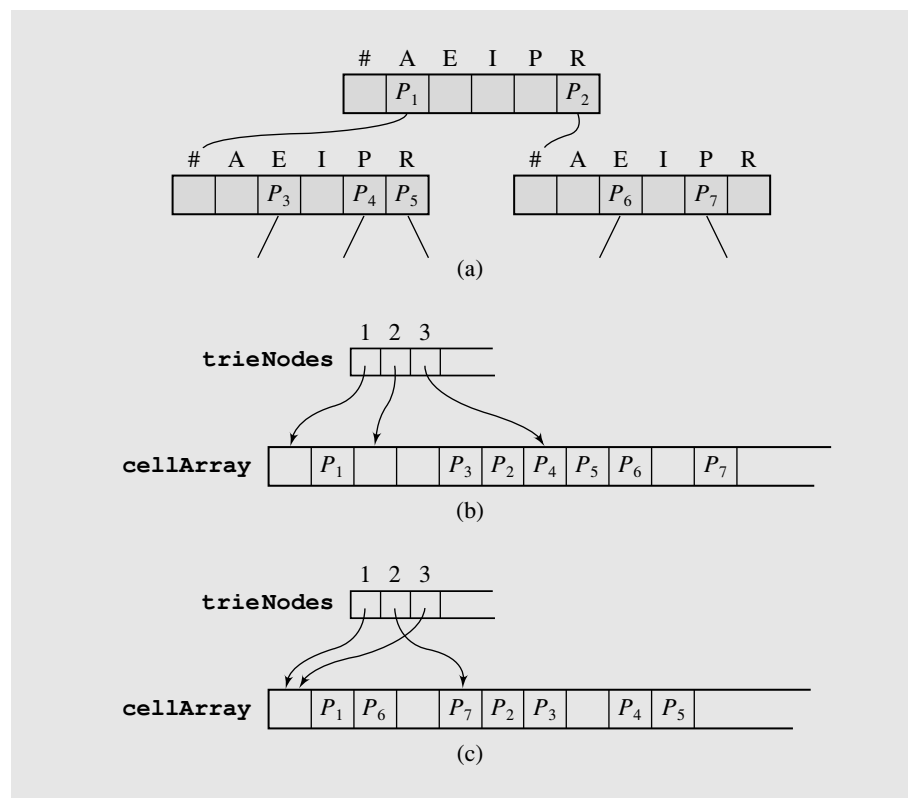
Another way to reduce the space requirements is by changing the way words are tested (Rotwitt and Maine, 1971). A trie *a tergo* can be built in which the reverses of words are inserted. In our example, the number of nodes is about the same, but a trie *a tergo* representation for such words as “logged,” “loggerhead,” “loggia,” and “logging” has leaves on the third level, not on the seventh, as in a forward trie. Admittedly, for some frequently used endings, such as “tion,” “ism,” and “ics,” the problem reappears.

A variety of other orders can be considered, and checking every second character proved to be very useful (Bourne and Ford, 1961), but solving the problem of an optimal order cannot be solved in its generality, because the problem turns out to be extremely complex (Comer and Sethi, 1977).



Another way to save space is to compress the trie. One method creates a large `cellArray` out of all the arrays in all nonleaf nodes by interleaving these arrays so that the references remain intact. The starting positions of these arrays are recorded in the encompassing `cellArray`. For example, the three nodes shown in Figure 7.39a containing references  $p_1$  through  $p_7$  to other nodes of the trie (including leaves) are put one by one into `cellArray` in a nonconflicting way, as in Figure 7.39b. The problem is how to do that efficiently timewise and spacewise so that the algorithm is fast and the resulting array occupies substantially less space than all nonleaf nodes combined. In this example, all three nodes require  $3 \cdot 6 = 18$  cells, and `cellArray` has 11 cells, so the compression rate is  $(18 - 11)/18$ , 39 percent. However, if the cells are stored as in Figure 7.39c, the compression rate is  $(18 - 10)/18$ , 44 percent.

**FIGURE 7.39** A part of a trie (a) before and (b) after compression using the `compressTrie()` algorithm and (c) after compressing it in an optimal way.



It turns out that the algorithm that compresses the trie is exponential in the number of nodes and inapplicable for large tries. Other algorithms may not render the optimal compression rate but are faster (cf. Al-Suwaiyel and Horowitz, 1984). One such algorithm is `compressTrie()`.

```

compressTrie()
  set to null all nodeNum*cellNum cells of cellArray;
  for each node
    for each position j of cellArray
      if after superimposing node on cellArray[j], ..., cellArray[j+cellNum-1]
         no cell containing a reference is superimposed on a cell with a reference
      copy reference cells from node to corresponding cells starting from cellArray[j];
      record j in trieNodes as the position of node in cellArray;
      break;

```

This is the algorithm that was applied to the trie in Figure 7.39a to render the arrays in Figure 7.39b. Searching such a compressed trie is similar to searching a regular trie. However, node accesses are mediated through the array `trieNodes`. If  $node_1$  refers to  $node_2$ , the position of  $node_2$  has to be found in this array, and then  $node_2$  can be accessed in `cellArray`.

The problem with using a compressed trie is that the search can lead us astray. For instance, a search for a word starting with the letter “P” is immediately discontinued in the trie in Figure 7.39a, because the reference field corresponding to this letter in the root node is null. On the other hand, in the compressed version of the same trie (Figure 7.39b), in the field corresponding to P, reference  $P_3$  can be found. But the misguided path is detected only after later encountering a null reference field or, after reaching a leaf, by comparing the key in this leaf with the key used in searching.

One more way to compress tries is by creating a C-trie, which is a bit version of the original trie (Maly, 1976). In this method, the nodes of one level of the C-trie are stored in consecutive locations of memory, and the addresses of the first nodes of each level are stored in a table of addresses. Information stored in particular nodes allows us to access the children of these nodes by computing the offsets from these nodes to their children.

Each node has four fields: a leaf/nonleaf flag, an end-of-word on/off field (which functions as our sharp-sign field), a K-field of *cellNum* bits corresponding to the cells with characters, and a C-field that gives the number of 1s in all the K-fields that are on the same level and precede this node. The latter integer is the number of nodes in the next level preceding the first child of this node.

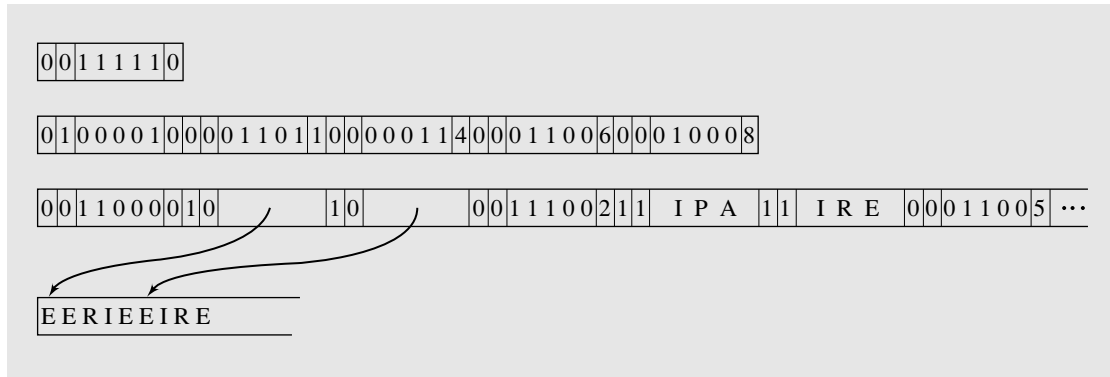
The leaves store actual keys (or suffixes of keys) if they fit into the K-field+C-field. If not, the key is stored in some table and the leaf contains a reference to its position in this table. The end-of-word field is used to distinguish between these two cases. A fragment of the C-trie version of the trie from Figure 7.39 is shown in Figure 7.40. All nodes are the same size. It is assumed that the leaf can store up to three characters.

To search a key in the C-trie, the offsets have to be computed very carefully. Here is an outline of the algorithm:

```

CTrieSearch(K)
  for (i = 1, p = the root; ; i++)
    if p is a leaf
      if K is equal to the key(p)
        success;

```

**FIGURE 7.40** A fragment of the C-trie representation of the trie from Figure 7.36.

```

else failure;
else if the end of word  $k$  is reached
    if end-of-word field is on
        success;
    else failure;
else if the bit corresponding to character  $K[i]$  is off
    failure;
else  $p = \text{address}(\text{the first node of level } i+1)$ 
     $+C\text{-field}(p) * \text{size}(\text{one node})$  // to skip all children of nodes
    // in front of  $p$  on level  $i$ ;
     $+ (\text{number of 1-bits in } K\text{-field}(p) \text{ to the left of the bit } // \text{to skip}$ 
     $\text{corresponding to } K[i]) * \text{size}(\text{one node})$  // some children of  $p$ ;

```

For example, to find “EERIE” in the C-trie in Figure 7.40, we first check in the root the bit corresponding to the first letter, “E.” Because the bit is on and the root is not a leaf, we go to the second level. On the second level, the address of the node to be tested is determined by adding the address of the first node on this level to the length of one node, the first, in order to skip it. The bit of this nonleaf node corresponding to the second letter of our word, also an “E,” is on, so we proceed to the third level. The address of the node to be tested is determined by adding the address of the first node of the third level to the size of one node (the first node of level three). We now access a leaf node with the end-of-word field set to 0. The table of words is accessed to make a comparison between the key looked for and the key in the table.

The compression is significant. One node of the original trie of 27 references of 2 bytes each occupies 54 bytes. One node of the C-trie requires  $1 + 1 + 27 + 32 = 61$  bits, which can be stored in 9 bytes. But it is not without a price. This algorithm requires putting nodes of one level tightly together, but storing one node at a time in memory by using `new` does not guarantee that the nodes are put in consecutive locations, especially in a multiuser environment. Therefore, the nodes from one level have to be generated first in temporary storage, and only then can a chunk of memory be requested that is large enough to accommodate all these nodes. This problem also indicates that

the C-trie is ill-suited for dynamic updates. If the trie is generated only once, the C-trie is an excellent variation to be utilized. If, however, the trie needs to be frequently updated, this technique for trie compression should be abandoned.

### 7.3 CONCLUDING REMARKS

The survey of multiway trees in this chapter is by no means exhaustive. The number of different types of multiway trees is very large. My intention is to highlight the variety of uses to which these trees can be applied and show how the same type of tree can be applied to different areas. Of particular interest is a B-tree with all its variations. B<sup>+</sup>-trees are commonly used in the implementation of indexes in today's relational databases. They allow very fast random access to the data, and they also allow fast sequential processing of the data.

The application of B-trees is not limited to processing information from secondary storage, although it was the original motivation in introducing these trees. A variant of B-trees, 2–4 trees, although unsuitable for processing information in secondary storage, turns out to be very useful in processing information in memory.

Also of particular use are tries, a different type of tree. With many variations, they have a vast scope of applications, and our case study illustrates one very useful application of tries.

### 7.4 CASE STUDY: SPELL CHECKER

An indispensable utility for any word processor is a spell checker, which allows the user to find as many spelling mistakes as possible. Depending on the sophistication of the spell checker, the user may even see possible corrections. Spell checkers are used mostly in an interactive environment; the user can invoke them at any time when using the word processor, make corrections on the fly, and exit even before processing the entire file. This requires writing a word processing program and, in addition to it, a spell checker module. This case study focuses on the use of tries. Therefore, the spell checker will be a stand-alone program to be used outside a word processor. It will process a text file in batch mode, not allowing word-by-word corrections after possible errors are detected.

The core of a spell checker is a data structure allowing efficient access to words in a dictionary. Such a dictionary most likely has thousands of words, so access has to be very fast to process a text file in a reasonable amount of time. Out of many possible data structures, the trie is chosen to store the dictionary words. The trie is first created after the spell checker is invoked using the file `dictionary`, and afterward, the actual spell checking takes place.

For a large number of dictionary words, the size of the trie is very important because it should reside in main memory without recourse to virtual memory. But as we have already observed in this chapter, tries with fixed length nodes, as in Figure 7.36, are too wasteful. In most cases, only a fraction of the positions in each node is utilized,



and the further away from the root, the smaller this fraction becomes (the root may be the only node with 26 children). Creating linked lists corresponding to all utilized letters for each node reduces wasted space, as in Figure 7.38. This approach has two disadvantages: The space required for the reference fields can be substantial, and the linked lists force us to use sequential search. An improvement over the last solution is to reserve only as much space as required by the letters used by each node without resorting to the use of linked lists. We could use the type `ArrayList` as an implementation of flexible arrays (arrays automatically growable), but it incurs an additional overhead: array lists store objects. Thus, to store a character in one, the `char` has to be cast to the `Character` class and then stored. The same is true for extracting values from array lists. Therefore, we will use strings as pseudoflexible arrays by substituting larger strings for existing strings.

The key to the use of such pseudoflexible arrays is the implementation of a node. There are three types of nodes: `TrieNode` with leaf/nonleaf flag and its subclasses, `TrieLeaf`, and `TrieNonLeaf`. `TrieNonLeaf` node has three additional fields: an end-of-word flag, a reference to a string, and a reference to an array of references to nodes. These references can be references to both leaves and nonleaves, and this is a reason why the superclass `TrieNode` is also used. The array is declared as an array of `TrieNode` so that assigning instances of its subclasses does not cause a compilation error. Figure 7.41 contains the trie utilizing the nodes of this structure. If a string attached to a certain node has to be extended, a new string is created that contains the contents of the old string with a new letter inserted into the proper position, a function performed by `addCell()`. The letters in each node are kept in alphabetical order.

The method `insert()` is an implementation of the algorithm `trieInsert()` discussed earlier in this chapter. Because the position of each letter may vary from one node to another, this position has to be determined each time, a function performed by `position()`. Should a letter be absent in a node, `position()` returns `-1`, which allows `insert()` to undertake the proper action.

Also, the discussion of tries in this chapter assumed that the leaves of the tries store full keys. This is not necessary because the prefixes of all words are implicitly stored in the trie and can be reconstructed by garnering all the letters on the path leading to the leaf. For example, to access the leaf with the word “ERIE,” two nonleaves have to be passed through references corresponding to the letters “E” and “R.” Therefore, it is enough to store the suffix “IE” in the leaf instead of the entire word “ERIE.” By doing this, only 13 letters of suffixes of these words have to be retained in these leaves out of the 58 letters stored in all leaves of the trie in Figure 7.36, a substantial improvement.

We also included the method `printTrie()`, which prints the content of a trie sideways. The output generated by this method when applied to the trie in Figure 7.41 is as follows:

```
>>REP
  >REA | R
>PI | ER
  >>PER
    >PEE | R
    >PEA | R
```



```

>IR|E
>IP|A
  >ERI|E
  >>ERE
  >>ERA
>EI|RE
>EE|RIE
  >>AREA
  >>>ARE
  >>ARA
>>>A

```

Three angle brackets indicate words for which the `endOfWord` flag has been set in a corresponding node and two angle brackets indicate words that have an empty leaf. The vertical bar in remaining words separates a prefix reconstructed when scanning the trie and a suffix that was extracted from a leaf.

Spell checking works in a straightforward fashion by examining each word of a text file and printing out all misspelled words along with the line numbers where the misspelled words are found. Figure 7.42 contains the complete code of the spell checker.

**FIGURE 7.42** Implementation of a spell checker using tries.

```

/***** Trie.java *****/
*
*/

class TrieNode {
    public boolean isLeaf;
}

class TrieNonLeaf extends TrieNode {
    public boolean endOfWord = false;
    public String letters;
    public TrieNode[] ptrs = new TrieNode[1];
    public TrieNonLeaf() {
        isLeaf = false;
    }
    public TrieNonLeaf(char ch) {
        letters = new String();
        letters += ch;
        isLeaf = false;
    }
}

```

*Continues*

**FIGURE 7.42** (continued)

```

class TrieLeaf extends TrieNode {
    public String suffix;
    public TrieLeaf() {
        isLeaf = true;
    }
    public TrieLeaf(String suffix) {
        this.suffix = new String(suffix);
        isLeaf = true;
    }
}

class Trie {
    public TrieNonLeaf root;
    public final int notFound = -1;
    public Trie() {
    }
    public Trie(String word) {
        root = new TrieNonLeaf(word.charAt(0)); // initialize the root
        createLeaf(word.charAt(0),word.substring(1),root); // to avoid later
    }
    public void printTrie() {
        printTrie(0,root,new String()); // assumption: the root is not null;
    }
    protected void printTrie(int depth, TrieNode p, String prefix) {
        if (p.isLeaf) {
            for (int j = 1; j <= depth; j++)
                System.out.print(" ");
            System.out.println(">" + prefix + "|" + ((TrieLeaf)p).suffix);
        }
        else {
            for (int i = ((TrieNonLeaf)p).letters.length()-1; i >= 0; i--) {
                if (((TrieNonLeaf)p).ptrs[i] != null) {
                    // add the letter corresponding to position i to prefix;
                    prefix = prefix.substring(0,depth) +
                        ((TrieNonLeaf)p).letters.charAt(i);
                    sideView(depth+1,((TrieNonLeaf)p).ptrs[i],prefix);
                }
                else { // if empty leaf;
                    for (int j = 1; j <= depth+1; j++)
                        System.out.print(" ");
                    System.out.println(">>" + prefix.substring(0,depth) +
                        ((TrieNonLeaf)p).letters.charAt(i));
                }
            }
        }
    }
}

```

**FIGURE 7.42** (continued)

```

    }
    if (((TrieNonLeaf)p).endOfWord) {
        for (int j = 1; j <= depth+1; j++)
            System.out.print(" ");
        System.out.println(" >>" + prefix.substring(0,depth));
    }
}
}
private int position(TrieNonLeaf p, char ch) {
    int i = 0;
    for ( ; i < p.letters.length() && p.letters.charAt(i) != ch; i++);
    if (i < p.letters.length())
        return i;
    else return notFound;
}
public boolean found(String word) {
    TrieNode p = root;
    int pos, i = 0;
    while (true)
        if (p.isLeaf) { // node p is a leaf
            TrieLeaf lf = (TrieLeaf) p; // where the matching
            if (word.substring(i).equals(lf.suffix)) // suffix of
                return true; // word should be found;
            else return false;
        }
        else if ((pos = position((TrieNonLeaf)p,word.charAt(i))) != notFound
            && i+1 == word.length()) // the end of word has to
            if (((TrieNonLeaf)p).ptrs[pos] == null) // correspond with
                return true; // an empty leaf
            else if(!(((TrieNonLeaf)p).ptrs[pos]).isLeaf &&
                ((TrieNonLeaf)((TrieNonLeaf)p).ptrs[pos]).endOfWord)
                return true; // or the endOfWord marker on;
            else return false;
        else if (pos != notFound && ((TrieNonLeaf)p).ptrs[pos] != null) {
            p = ((TrieNonLeaf)p).ptrs[pos]; // continue path,
            i++; // if possible,
        }
        else return false; // otherwise failure;
}
private void addCell(char ch, TrieNonLeaf p, int stop) {
    int i;

```

*Continues*

**FIGURE 7.42** (continued)

```

    int len = p.letters.length();
    char[] s = new char[len+1];
    TrieNode[] tmp = p.ptrs;
    p.ptrs = new TrieNode[len+1];
    for (i = 0; i < len+1; i++)
        p.ptrs[i] = null;
    if (stop < len) // if ch does not follow all letters in p,
        for (i = len; i >= stop+1; i--) { // copy from tmp letters > ch;
            p.ptrs[i] = tmp[i-1];
            s[i] = p.letters.charAt(i-1);
        }
    s[stop] = ch;
    for (i = stop-1; i >= 0; i--) { // and letters < ch;
        p.ptrs[i] = tmp[i];
        s[i] = p.letters.charAt(i);
    }
    p.letters = new String(s);
}
private void createLeaf(char ch, String suffix, TrieNonLeaf p) {
    int pos = position(p,ch);
    TrieLeaf lf = null;
    if (suffix != null && suffix.length() > 0) // don't create any leaf
        lf = new TrieLeaf(suffix); // if there is no suffix;
    if (pos == notFound) {
        for (pos = 0; pos < p.letters.length() &&
            p.letters.charAt(pos) < ch; pos++);
        addCell(ch,p,pos);
    }
    p.ptrs[pos] = lf;
}
public void insert(String word) {
    TrieNonLeaf p = root;
    TrieLeaf lf;
    int offset, pos, i = 0;
    while (true) {
        if (i == word.length()) { // if the end of word reached, then
            if (p.endOfWord) // set endOfWord to true;
                System.out.println("duplicate entry1: " + word);
            p.endOfWord = true; // set endOfWord to true;
            return;
        } // if position in p indicated

```

**FIGURE 7.42** (continued)

```

pos = position(p,word.charAt(i));
if (pos == notFound) {           // by the first letter of word
    createLeaf(word.charAt(i),word.substring(i+1),p);
                                // does not exist, create
    return;                       // a leaf and store in it the
}                                 // unprocessed suffix of word;
else if (pos != notFound &&      // empty leaf in position pos;
        p.ptrs[pos] == null) {
    if (i+1 == word.length()) {
        System.out.println("duplicate entry1: " + word);
        return;
    }
    p.ptrs[pos] = new TrieNonLeaf(word.charAt(i+1));
    ((TrieNonLeaf)(p.ptrs[pos])).endOfWord = true;
    // check whether there is any suffix left:
    String s = (word.length() > i+2) ? word.substring(i+2) : null;
    createLeaf(word.charAt(i+1),s,(TrieNonLeaf)(p.ptrs[pos]));
    return;
}
else if (pos != notFound &&      // if position pos is
        p.ptrs[pos].isLeaf) {    // occupied by a leaf,
    lf = (TrieLeaf) p.ptrs[pos]; // hold this leaf;
    if (lf.suffix.equals(word.substring(i+1))) {
        System.out.println("duplicate entry2: " + word);
        return;
    }
    offset = 0;
    // create as many nonleaves as the length of identical
    // prefix of word and the string in the leaf (for cell 'R',
    // leaf "EP", and word "REAR", two such nodes are created);
    do {
        pos = position(p,word.charAt(i+offset));
        // word = "ABC", leaf = "ABCDEF" => leaf = "DEF";
        if (word.length() == i+offset+1) {
            p.ptrs[pos] = new TrieNonLeaf(lf.suffix.charAt(offset));
            p = (TrieNonLeaf) p.ptrs[pos];
            p.endOfWord = true;
            createLeaf(lf.suffix.charAt(offset),
                       lf.suffix.substring(offset+1),p);
            return;
        }
    }
}

```

*Continues*





**FIGURE 7.42** (continued)

```

/***** SpellCheck.java *****/
*
*/

import java.io.*;

public class SpellCheck {
    static int lineNum = 1;
    static String s;
    static int ch;
    static void readWord(InputStream fIn) {
        try {
            while (true)
                if (ch > -1 && !Character.isLetter((char)ch)) { // skip
                    ch = fIn.read(); // nonletters;
                    if (ch == '\n')
                        lineNum++;
                }
                else break;
            if (ch == -1)
                return;
            s = "";
            while (ch > -1 && Character.isLetter((char)ch)) {
                s += Character.toUpperCase((char)ch);
                ch = fIn.read();
            }
        } catch (IOException io) {
            System.out.println("Problem with input.");
        }
    }
    static public void main(String args[]) {
        String fileName = "";
        InputStream fIn, dictionary;
        InputStreamReader isr = new InputStreamReader(System.in);
        BufferedReader buffer = new BufferedReader(isr);
        Trie trie = null;
        try {
            dictionary = new FileInputStream("dictionary");
            readWord(dictionary);
            trie = new Trie(s.toUpperCase()); // initialize root;
            while (ch > -1) {

```

*Continues*

**FIGURE 7.42** (continued)

```
        readWord(dictionary);
        if (ch == -1)
            break;
        trie.insert(s);
    }
    dictionary.close();
} catch(IOException io) {
    System.err.println("Cannot open dictionary");
}
System.out.println("\nTrie: ");
trie.printTrie();
ch = ' ';
lineNum = 1;
try {
    if (args.length == 0) {
        System.out.print("Enter a file name: ");
        fileName = buffer.readLine();
        fIn = new FileInputStream(fileName);
    }
    else {
        fIn = new FileInputStream(args[0]);
        fileName = args[0];
    }
    System.out.println("Misspelled words:");
    while (true) {
        readWord(fIn);
        if (ch == -1)
            break;
        if (!trie.found(s))
            System.out.println(s + " on line " + lineNum);
    }
    fIn.close();
} catch(IOException io) {
    System.err.println("Cannot open " + fileName);
}
}
```

## 7.5

## EXERCISES

1. What is the maximum number of nodes in a multiway tree of height  $h$ ?
2. How many keys can a B-tree of order  $m$  and of height  $h$  hold?
3. Write a method that prints out the contents of a B-tree in ascending order.
4. The root of a  $B^+$ -tree requires special attention because it has no sibling. A split does not render two nodes two-thirds full plus a new root with one key. Suggest some solutions to this problem.
5. Are B-trees immune to the order of the incoming data? Construct B-trees of order 3 (two keys per node) first for the sequence 1, 5, 3, 2, 4 and then for the sequence 1, 2, 3, 4, 5. Is it better to initialize B-trees with ordered data or with data in random order?
6. Draw all 10 different B-trees of order 3 that can store 15 keys and make a table that for each of these trees shows the number of nodes and the average number of visited nodes (Rosenberg and Snyder, 1981). What generalization can you make about them? Would this table indicate that (a) the smaller the number of nodes, the smaller the average number of visited nodes and (b) the smaller the average number of visited nodes, the smaller the number of nodes? What characteristics of the B-tree should we concentrate on to make them more efficient?
7. In all our considerations concerning B-trees, we assumed that the keys are unique. However, this does not have to be the case because multiple occurrences of the same key in a B-tree do not violate the B-tree property. If these keys refer to different objects in the data file (e.g., if the key is a name, and many people can have the same name), how would you implement such data file references?
8. What is the maximum height of a  $B^+$ -tree with  $n$  keys?
9. Occasionally, in a simple prefix  $B^+$ -tree, a separator can be as large as a key in a leaf. For example, if the last key in one leaf is “Herman” and the first key in the next leaf is “Hermann,” then “Hermann” must be chosen as a separator in the parent of these leaves. Suggest a procedure to enforce the shorter separator.
10. Write a method that determines the shortest separator for two keys in a simple prefix  $B^+$ -tree.
11. Is it a good idea to use abbreviated forms of prefixes in the leaves of prefix  $B^+$ -trees?
12. If in two different positions,  $i$  and  $j$ ,  $i < j$ , of a leaf in a bit-tree two D-bits are found such that  $D_j = D_i$ , what is the condition on at least one of the D-bits  $D_k$  for  $i < k < j$ ?
13. If key  $K_i$  is deleted from a leaf of a bit-tree, then the D-bit between  $K_{i-1}$  and  $K_{i+1}$  has to be modified. What is the value of this D-bit if the values  $D_i$  and  $D_{i+1}$  are known? Make deletions in the leaf in Figure 7.17 to make an educated guess and then generalize this observation. In making a generalization, consider two cases: (a)  $D_i < D_{i+1}$  and (b)  $D_i > D_{i+1}$ .
14. Write an algorithm that, for an R-tree, finds all entries in the leaves whose rectangles overlap a search rectangle  $R$ .

15. In the discussion of B-trees, which are comparable in efficiency to binary search trees, why are only B-trees of small order used and not B-trees of large order?
16. What is the worst case of inserting a key into a 2–4 tree?
17. What is the complexity of the `compressTrie()` algorithm in the worst case?
18. Can the leaves of the trie compressed with `compressTrie()` still have abbreviated versions of the words, namely, parts that are not included in the nonterminal nodes?
19. In the examples of tries analyzed in this chapter, we dealt with only 26 capital letters. A more realistic setting includes lowercase letters as well. However, some words require a capital letter at the beginning (names), and some require the entire word to be capitalized (acronyms). How can we solve this problem without including both lowercase and capital letters in the nodes?
20. A variant of a trie is a *digital tree*, which processes information on the level of bits. Because there are only two bits, only two outcomes are possible. Digital trees are binary. For example, to test whether the word “BOOK” is in the tree, we do not use the first letter, “B,” in the root to determine to which of its children we should go, but the first bit, 0, of the first letter ( $\text{ASCII}(\text{B}) = 01000010$ ), on the second level, the second bit, and so on before we get to the second letter. Is it a good idea to use a digital tree for a spell checking program, as was discussed in the case study?

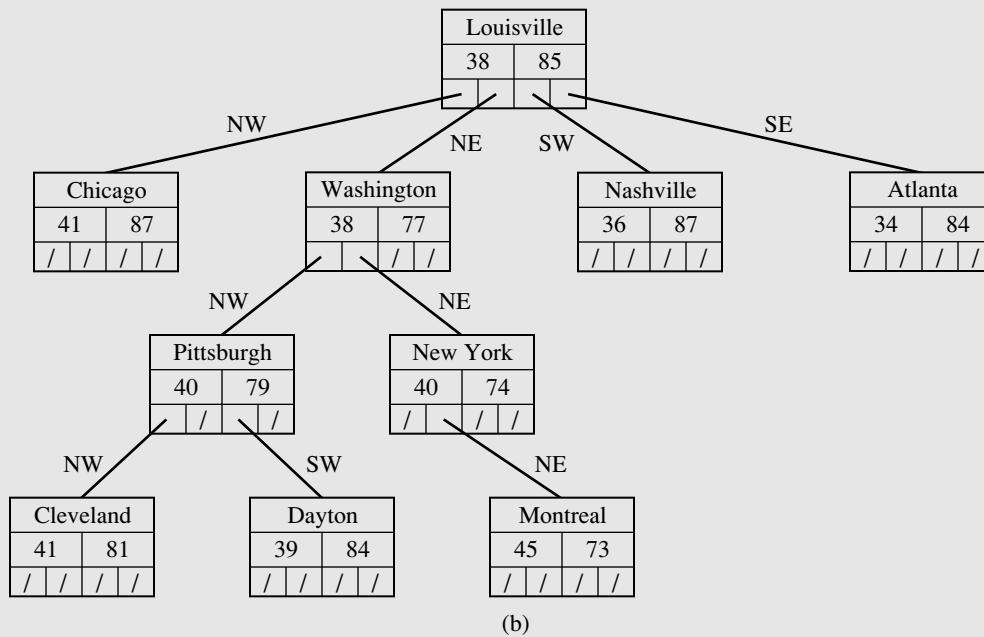
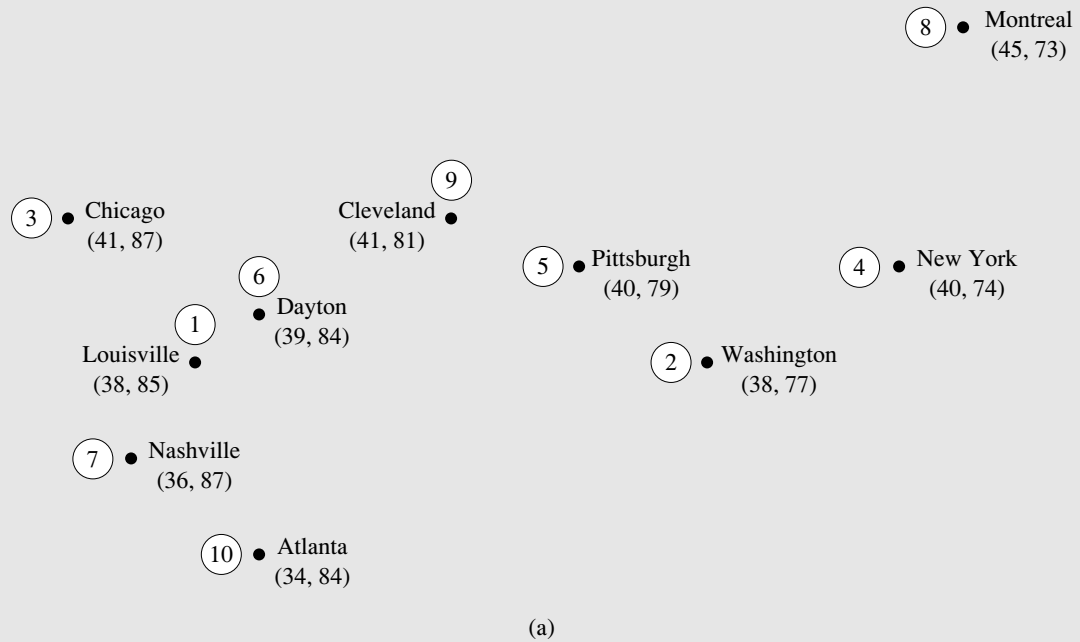
## 7.6

## PROGRAMMING ASSIGNMENTS

1. Extend our spell checking program to suggest the proper spelling of a misspelled word. Consider these types of misspellings: changing the order of letters (copmuter), omitting a letter (computr), adding a letter (compueter), dittography, i.e., repeating a letter (computer), and changing a letter (compurer). For example, if the letter  $i$  is exchanged with the letter  $i + 1$ , then the level  $i$  of the trie should be processed before level  $i + 1$ .
2. A *point quadtree* is a 4-way tree used to represent points on a plane (Samet, 1989). A node contains a pair of coordinates (*latitude, longitude*) and references to four children that represent four quadrants, NW, NE, SW, and SE. These quadrants are generated by the intersection of the vertical and horizontal lines passing through point ( $lat, lon$ ) of the plane. Write a program that accepts the names of cities and their geographical locations ( $lat, lon$ ) and inserts them into the quadtree. Then, the program should give the names of all cities located within distance  $r$  from a location ( $lat, lon$ ) or, alternatively, within distance  $r$  from a city  $C$ .

Figure 7.43 contains an example. Locations on the map in Figure 7.43a are inserted into the quadtree in Figure 7.43b in the order indicated by the encircled numbers shown next to the city names. For instance, when inserting Pittsburgh into the quadtree, we check in which direction it is with respect to the root. The root stores the coordinates of Louisville, and Pittsburgh is NE from it; that is, it belongs to the second child of the root. But this child already stores a city, Washington. Therefore, we ask the same question concerning Pittsburgh with respect to the current node, the second child of the root: In which direction with respect to this city is Pittsburgh? This time the answer is NW. Therefore, we go to the first child of the current node. The child is a null node, and therefore, the Pittsburgh node can be inserted here.

**FIGURE 7.43** A map indicating (a) coordinates of some cities and (b) a quadtree containing the same cities.



The problem is to not do an exhaustive search of the quadtree. So, if we are after cities within a radius  $r$  from a city  $C$ , then, for a particular node  $nd$  you find the distance between  $C$  and the city represented by  $nd$ . If the distance is within  $r$ , you have to continue to all four descendants of  $nd$ . If not, you continue to the descendants indicated by the relative positions. To measure a distance between cities with coordinates  $(lat_1, lon_1)$  and  $(lat_2, lon_2)$ , the great circle distance formula can be used:

$$d = R \arccos(\sin(lat_1) \cdot \sin(lat_2) + \cos(lat_1) \cdot \cos(lat_2) \cdot \cos(lon_2 - lon_1))$$

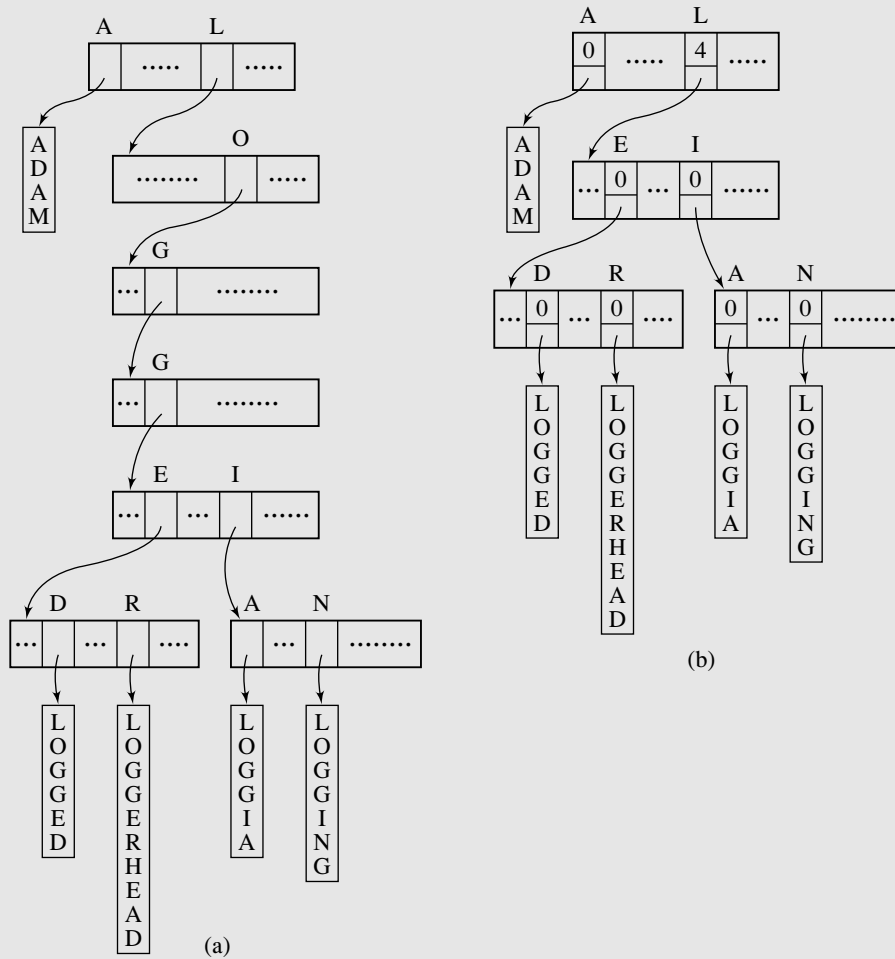
assuming that the earth radius  $R = 3,956$  miles and latitudes and longitudes are expressed in radians (to convert decimal degrees to radians, multiply the number of degrees by  $\pi/180 = 0.017453293$  radians/degree). Also, for the directions west and south, negative angles should be used.

For example, to find cities within the distance of 200 miles from Pittsburgh, begin with the root and  $d((38,85),(40,79)) = 350$ , so Louisville does not qualify, but now you need to continue only in the SE and NE descendants of Louisville after comparing the coordinates of Louisville and Pittsburgh. Then you try Washington, which qualifies ( $d = 175$ ), so, from Washington you go to Pittsburgh and then to both Pittsburgh's descendants. But when you get to the NE node from Washington, you see that New York does not qualify ( $d = 264$ ), and from New York you would have to continue in SW and NW descendants, but they are null, so you stop right there. Also, Atlanta needs to be checked.

3. Figure 7.36 indicates one source of inefficiency for tries: The path to "REAR" and "REP" leads through a node that has just one child. For longer identical prefixes, the number of such nodes can be even longer. Implement a spell checker with a variation of the trie, called the *multiway Patricia tree* (Morrison, 1968),<sup>4</sup> which curtails the paths in the trie by avoiding nodes with only one child. It does this by indicating for each branch how many characters should be skipped to make a test. For example, a trie from Figure 7.44a is transformed into a Patricia tree in Figure 7.44b. The paths leading to the four words with prefix "LOGG" are shortened at the cost of recording in each node the number of characters to be omitted starting from the current position in a string. Now, because certain characters are not tested along the way, the final test should be between a key searched for and the *entire* key found in a specific leaf.
4. The definition of a B-tree stipulates that the nodes have to be half full, and the definition of a B\*-tree increases this requirement to two-thirds. The reason for these requirements is to achieve reasonably good disk space utilization. However, it may be claimed that B-trees can perform very well requiring only that they include no empty nodes. To distinguish between these two cases, the B-trees discussed in this chapter are called *merge-at-half* B-trees, and the other type, when nodes must have at least one element, are called *free-at-empty* B-trees. It turns out, for example, that after a free-at-empty B-tree is built and then each insertion is followed by deletion, the space utilization is about 39 percent (Johnson and Shasha, 1993), which is not bad considering the fact that this type of tree can have very small space utilization ( $\frac{1}{m} \cdot 100\%$  for a tree of order  $m$ ), whereas a merge-at-half B-tree has at least 50 percent utilization.

<sup>4</sup>The original Patricia tree was a binary tree, and the tests were made on the level of bits.

**FIGURE 7.44** (a) A trie with words having long identical prefixes and (b) a Patricia tree with the same words.



Therefore, it may be expected that if the number of insertions outweighs the number of deletions, the gap between merge-at-half and free-at-empty B-trees will be bridged. Write a simulation program to check this contention. First build a large B-tree, and then run a simulation for this tree treating it as a merge-at-half B-tree and then as a free-at-empty B-tree for different ratios of number  $i$  of insertions to number  $d$  of deletions, so that  $\frac{i}{d} \geq 1$ ; that is, the number of insertions is not less than the number of deletions (the case when deletions outweigh insertions is not interesting, because eventually the tree would disappear). Compare the space utilization for these different cases. For what ratio  $\frac{i}{d}$  is the space utilization between these two types of B-trees

sufficiently close (say, within 5–10 percent difference)? After how many deletions and insertions is this similar utilization accomplished? Does the order of the tree have an impact on the difference of space utilization? One advantage of using free-at-empty trees would be to decrease the probability of tree restructuring. In all cases, compare the tree restructuring rate for both types of B-trees.

## BIBLIOGRAPHY

### *B-Trees*

- Bayer, R., “Symmetric Binary B-Trees: Data Structures and Maintenance Algorithms,” *Acta Informatica* 1 (1972), 290–306.
- Bayer, R., and McCreight, E., “Organization and Maintenance of Large Ordered Indexes,” *Acta Informatica* 1 (1972), 173–189.
- Bayer, Rudolf, and Unterauer, Karl, “Prefix B-Trees,” *ACM Transactions on Database Systems* 2 (1977), 11–26.
- Comer, Douglas, “The Ubiquitous B-Tree,” *Computing Surveys* 11 (1979), 121–137.
- Ferguson, David E., “Bit-Tree: A Data Structure for Fast File Processing,” *Communications of the ACM* 35 (1992), No. 6, 114–120.
- Folk, Michael J., Zoellick, Bill, and Riccardi, Greg, *File Structures: An Object-Oriented Approach with C++*, Reading, MA: Addison-Wesley (1998), Chs. 9, 10.
- Guibas, Leo J., and Sedgwick, Robert, “A Dichromatic Framework for Balanced Trees,” *Proceedings of the 19th Annual Symposium on Foundation of Computer Science* (1978), 8–21.
- Guttman, Antonin, “R-Trees: A Dynamic Index Structure for Spatial Searching,” *ACM SIGMOD ’84 Proc. of Annual Meeting, SIGMOD Record* 14 (1984), 47–57 [also in Stonebraker, Michael (ed.), *Readings in Database Systems*, San Mateo, CA: Kaufmann (1988), 599–609].
- Johnson, Theodore, and Shasha, Dennis, “B-Trees with Inserts and Deletes: Why Free-at-Empty Is Better Than Merge-at-Half,” *Journal of Computer and System Sciences* 47 (1993), 45–76.
- Leung, Clement H. C., “Approximate Storage Utilization of B-Trees: A Simple Derivation and Generalizations,” *Information Processing Letters* 19 (1984), 199–201.
- McCreight, Edward M., “Pagination of B<sup>+</sup>-Trees with Variable-Length Records,” *Communications of the ACM* 20 (1977), 670–674.
- Rosenberg, Arnold L., and Snyder, Lawrence, “Time- and Space-Optimality in B-Trees,” *ACM Transactions on Database Systems* 6 (1981), 174–193.
- Sedgwick, Robert, *Algorithms*, Reading, MA: Addison-Wesley (1998), Ch. 13.
- Sellis, Timos, Roussopoulos, Nick, and Faloutsos, Christos, “The R<sup>+</sup>-Tree: A Dynamic Index for Multi-Dimensional Objects,” *Proceedings of the 13th Conference on Very Large Databases* (1987), 507–518.



Stonebraker, M., Sellis, T., and Hanson, E., "Analysis of Rule Indexing Implementations in Data Base Systems," *Proceedings of the First International Conference on Expert Database Systems*, Charleston, SC (1986), 353–364.

Wedekind, H., "On the Selection of Access Paths in a Data Base System," in Klimbie, J. W., and Koffeman, K. L. (eds.), *Data Base Management*, Amsterdam: North-Holland (1974), 385–397.

Yao, Andrew Chi-Chih, "On Random 2–3 Trees," *Acta Informatica* 9 (1978), 159–170.

### *Tries*

Bourne, Charles P., and Ford, Donald F., "A Study of Methods for Systematically Abbreviating English Words and Names," *Journal of the ACM* 8 (1961), 538–552.

Briandais, Rene de la, "File Searching Using Variable Length Keys," *Proceedings of the Western Joint Computer Conference* (1959), 295–298.

Comer, Douglas, and Sethi, Ravi, "The Complexity of Trie Index Construction," *Journal of the ACM* 24 (1977), 428–440.

Fredkin, Edward, "Trie Memory," *Communications of the ACM* 3 (1960), 490–499.

Maly, Kurt, "Compressed Tries," *Communications of the ACM* 19 (1976), 409–415.

Morrison, Donald R., "Patricia Trees," *Journal of the ACM* 15 (1968), 514–534.

Rotwitt, T., and de Maine, P. A. D., "Storage Optimization of Tree Structured Files Representing Descriptor Sets," *Proceedings of the ACM SIGFIDET Workshop on Data Description, Access and Control*, New York (1971), 207–217.

Al-Suwaiyel, M., and Horowitz, E., "Algorithms for Trie Compaction," *ACM Transactions on Database Systems* 9 (1984), 243–263.

### *Quadtrees*

Finkel, R. A., and Bentley, J. L., "Quad Trees: A Data Structure for Retrieval on Composite Keys," *Acta Informatica* 4 (1974), 1–9.

Samet, Hanan, *The Design and Analysis of Spatial Data Structures*, Reading, MA: Addison-Wesley, 1989.

# 8

# Graphs

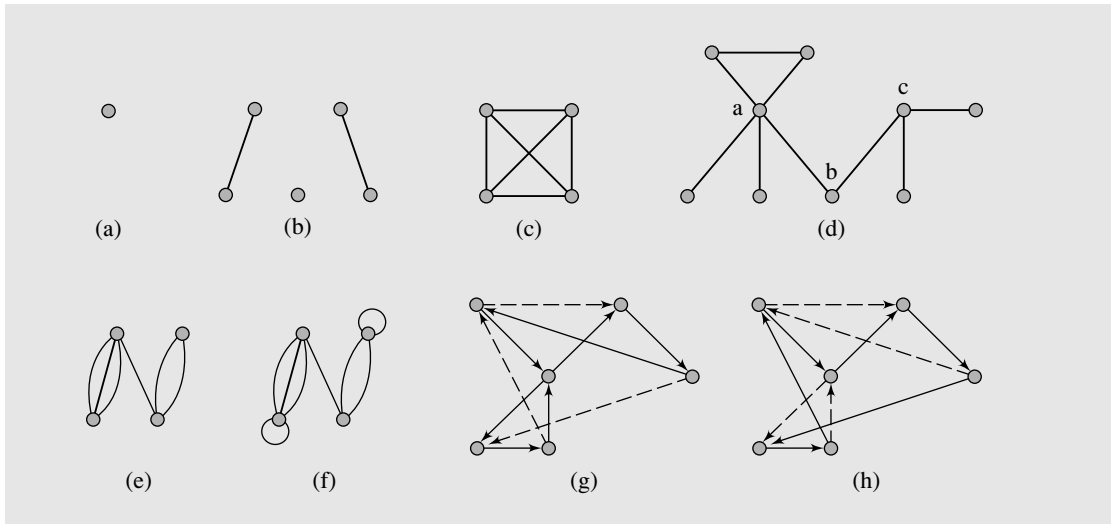
In spite of the flexibility of trees and the many different tree applications, trees, by their nature, have one limitation, namely, they can only represent relations of a hierarchical type, such as relations between parent and child. Other relations are only represented indirectly, such as the relation of being a sibling. A generalization of a tree, a *graph*, is a data structure in which this limitation is lifted. Intuitively, a graph is a collection of vertices (or nodes) and the connections between them. Generally, no restriction is imposed on the number of vertices in the graph or on the number of connections one vertex can have to other vertices. Figure 8.1 contains examples of graphs. Graphs are versatile data structures that can represent a large number of different situations and events from diverse domains. Graph theory has grown into a sophisticated area of mathematics and computer science in the last 200 years since it was first studied. Many results are of theoretical interest, but in this chapter, some selected results of interest to computer scientists are presented. Before discussing different algorithms and their applications, several definitions need to be introduced.

A *simple graph*  $G = (V, E)$  consists of a nonempty set  $V$  of *vertices* and a possibly empty set  $E$  of *edges*, each edge being a set of two vertices from  $V$ . The number of vertices and edges is denoted by  $|V|$  and  $|E|$ , respectively. A *directed graph*, or a *digraph*,  $G = (V, E)$  consists of a nonempty set  $V$  of vertices and a set  $E$  of edges (also called *arcs*), where each edge is a pair of vertices from  $V$ . The difference is that one edge of a simple graph is of the form  $\{v_i, v_j\}$ , and for such an edge,  $\{v_i, v_j\} = \{v_j, v_i\}$ . In a digraph, each edge is of the form  $(v_i, v_j)$ , and in this case,  $(v_i, v_j) \neq (v_j, v_i)$ . Unless necessary, this distinction in notation will be disregarded, and an edge between vertices  $v_i$  and  $v_j$  will be referred to as  $edge(v_i, v_j)$ .

These definitions are restrictive in that they do not allow for two vertices to have more than one edge. A *multigraph* is a graph in which two vertices can be joined by multiple edges. Geometric interpretation is very simple (see Figure 8.1e). Formally, the definition is as follows: A multigraph  $G = (V, E, f)$  is composed of a set of vertices  $V$ , a set of edges  $E$ , and a function  $f: E \rightarrow \{\{v_i, v_j\} : v_i, v_j \in V \text{ and } v_i \neq v_j\}$ . A *pseudograph* is a multigraph with the condition  $v_i \neq v_j$  removed, which allows for *loops* to occur; in a pseudograph, a vertex can be joined with itself by an edge (Figure 8.1f).

A *path* from  $v_1$  to  $v_n$  is a sequence of edges  $edge(v_1, v_2), edge(v_2, v_3), \dots, edge(v_{n-1}, v_n)$  and is denoted as path  $v_1, v_2, v_3, \dots, v_{n-1}, v_n$ . If  $v_1 = v_n$  and no edge is repeated, then the

**FIGURE 8.1** Examples of graphs: (a–d) simple graphs; (c) a complete graph  $K_4$ ; (e) a multigraph; (f) a pseudograph; (g) a circuit in a digraph; (h) a cycle in the digraph.



path is called a *circuit* (Figure 8.1g). If all vertices in a circuit are different, then it is called a *cycle* (Figure 8.1h).

A graph is called a *weighted graph* if each edge has an assigned number. Depending on the context in which such graphs are used, the number assigned to an edge is called its weight, cost, distance, length, or some other name.

A graph with  $n$  vertices is called *complete* and is denoted  $K_n$  if for each pair of distinct vertices there is exactly one edge connecting them; that is, each vertex can be connected to any other vertex (Figure 8.1c). The number of edges in such a graph  $|E| =$

$$\binom{|V|}{2} = \frac{|V|!}{2!(|V|-2)!} = \frac{|V|(|V|-1)}{2} = O(|V|^2).$$

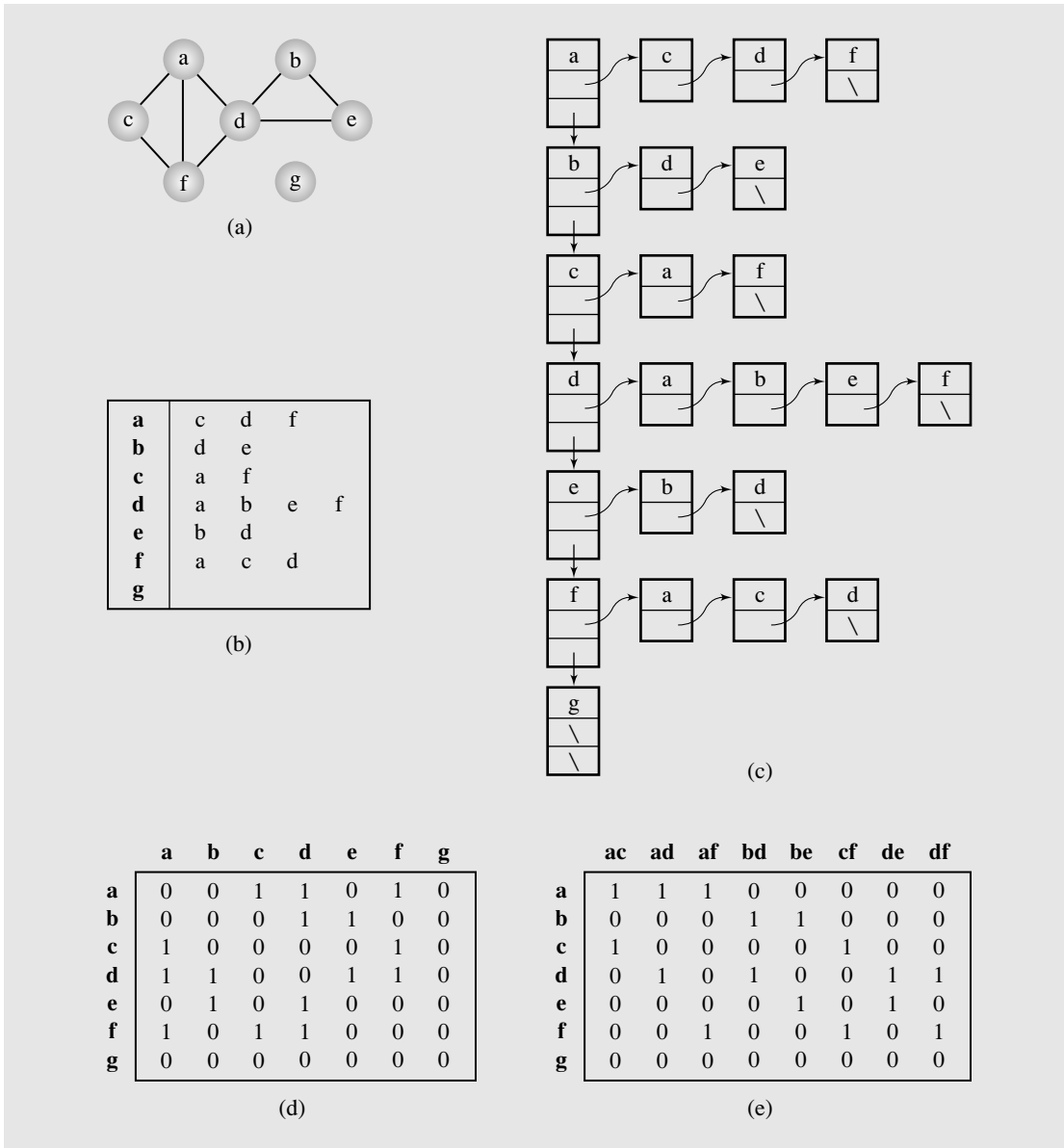
A *subgraph*  $G'$  of graph  $G = (V, E)$  is a graph  $(V', E')$  such that  $V' \subseteq V$  and  $E' \subseteq E$ . A subgraph *induced* by vertices  $V'$  is a graph  $(V', E')$  such that an edge  $e \in E'$  if  $e \in E$ .

Two vertices  $v_i$  and  $v_j$  are called *adjacent* if the edge  $(v_i, v_j)$  is in  $E$ . Such an edge is called *incident with* the vertices  $v_i$  and  $v_j$ . The *degree* of a vertex  $v$ ,  $\text{deg}(v)$ , is the number of edges incident with  $v$ . If  $\text{deg}(v) = 0$ , then  $v$  is called an *isolated vertex*. Part of the definition of a graph indicating that the set of edges  $E$  can be empty allows for a graph consisting only of isolated vertices.

## 8.1 GRAPH REPRESENTATION

There are various ways to represent a graph. A simple representation is given by an *adjacency list* which specifies all vertices adjacent to each vertex of the graph. This list can be implemented as a table, in which case it is called a *star representation*, which can be forward or reverse, as illustrated in Figure 8.2b, or as a linked list (Figure 8.2c).

**FIGURE 8.2** Graph representations. (a) A graph represented as (b–c) an adjacency list, (d) an adjacency matrix, and (e) an incidence matrix.



Another representation is a matrix, which comes in two forms: an adjacency matrix and an incidence matrix. An *adjacency matrix* of graph  $G = (V, E)$  is a binary  $|V| \times |V|$  matrix such that each entry of this matrix

$$a_{ij} = \begin{cases} 1 & \text{if there exists an } \textit{edge}(v_i, v_j) \\ 0 & \text{otherwise} \end{cases}$$

An example is shown in Figure 8.2d. Note that the order of vertices  $v_1, \dots, v_{|V|}$  used for generating this matrix is arbitrary; therefore, there are  $n!$  possible adjacency matrices for the same graph  $G$ . Generalization of this definition to also cover multigraphs can be easily accomplished by transforming the definition into the following form:

$$a_{ij} = \text{number of edges between } v_i \text{ and } v_j$$

Another matrix representation of a graph is based on the incidence of vertices and edges and is called an *incidence matrix*. An incidence matrix of graph  $G = (V, E)$  is a  $|V| \times |E|$  matrix such that

$$a_{ij} = \begin{cases} 1 & \text{if edge } e_j \text{ is incident with vertex } v_i \\ 0 & \text{otherwise} \end{cases}$$

Figure 8.2e contains an example of an incidence matrix. In an incidence matrix for a multigraph, some columns are the same, and a column with only one 1 indicates a loop.

Which representation is best? It depends on the problem at hand. If our task is to process vertices adjacent to a vertex  $v$ , then the adjacency list requires only  $\textit{deg}(v)$  steps, whereas the adjacency matrix requires  $|V|$  steps. On the other hand, inserting or deleting a vertex adjacent to  $v$  requires linked list maintenance for an adjacency list (if such an implementation is used); for a matrix, it requires only changing 0 to 1 for insertion, or 1 to 0 for deletion, in one cell of the matrix.

## 8.2 GRAPH TRAVERSALS

As in trees, traversing a graph consists of visiting each vertex only one time. The simple traversal algorithms used for trees cannot be applied here because graphs may include cycles; hence, the tree traversal algorithms would result in infinite loops. To prevent that from happening, each visited vertex can be marked to avoid revisiting it. However, graphs can have isolated vertices, which means that some parts of the graph are left out if unmodified tree traversal methods are applied.

An algorithm for traversing a graph, known as the depth-first search algorithm, was developed by John Hopcroft and Robert Tarjan. In this algorithm, each vertex  $v$  is visited and then each unvisited vertex adjacent to  $v$  is visited. If a vertex  $v$  has no adjacent vertices or all of its adjacent vertices have been visited, we backtrack to the predecessor of  $v$ . The traversal is finished if this visiting and backtracking process leads to the first vertex where the traversal started. If there are still some unvisited vertices in the graph, the traversal continues restarting for one of the unvisited vertices.

Although it is not necessary for the proper outcome of this method, the algorithm assigns a unique number to each accessed vertex so that vertices are now renumbered. This will prove useful in later applications of this algorithm.

```
DFS(v)
    num(v) = i++;
    for all vertices u adjacent to v
```

```

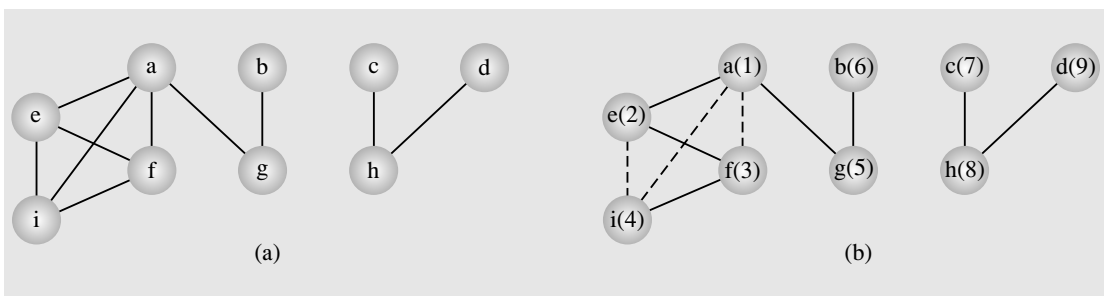
    if num(u) is 0
        attach edge(uv) to edges;
        DFS(u);

depthFirstSearch()
    for all vertices v
        num(v) = 0;
    edges = null;
    i = 1;
    while there is a vertex v such that num(v) is 0
        DFS(v);
    output edges;

```

Figure 8.3 contains an example with the numbers  $num(v)$  assigned to each vertex  $v$  shown in parentheses. Having made all necessary initializations, `depthFirstSearch()` calls `DFS(a)`. `DFS()` is first invoked for vertex  $a$ ;  $num(a)$  is assigned number 1.  $a$  has four adjacent vertices, and vertex  $e$  is chosen for the next invocation, `DFS(e)`, which assigns number 2 to this vertex, that is,  $num(e) = 2$ , and puts the  $edge(ae)$  in `edges`. Vertex  $e$  has two unvisited adjacent vertices, and `DFS()` is called for the first of them, the vertex  $f$ . The call `DFS(f)` leads to the assignment  $num(f) = 3$  and puts the  $edge(ef)$  in `edges`. Vertex  $f$  has only one unvisited adjacent vertex,  $i$ ; thus, the fourth call, `DFS(i)`, leads to the assignment  $num(i) = 4$  and to the attaching of  $edge(fi)$  to `edges`. Vertex  $i$  has only visited adjacent vertices; hence, we return to call `DFS(f)` and then to `DFS(e)` in which vertex  $i$  is accessed only to learn that  $num(i)$  is not 0, whereby the  $edge(ei)$  is not included in `edges`. The rest of the execution can be seen easily in Figure 8.3b. Solid lines indicate edges included in the set `edges`.

**FIGURE 8.3** An example of application of the `depthFirstSearch()` algorithm to a graph.

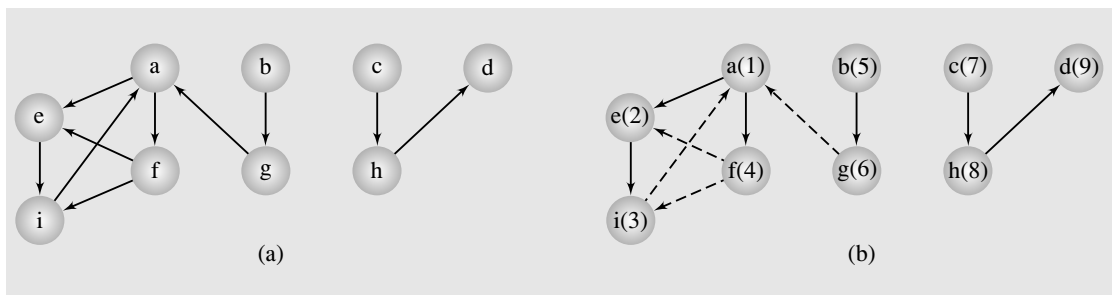


Note that this algorithm guarantees generating a tree (or a forest, a set of trees) that includes or spans over all vertices of the original graph. A tree that meets this condition is called a *spanning tree*. The fact that a tree is generated is ascertained by the fact that the algorithm does not include in the resulting tree any edge that leads from the currently analyzed vertex to a vertex already analyzed. An edge is added to `edges` only if the condition “if  $num(u)$  is 0” is true; that is, if vertex  $u$  reachable

from vertex  $v$  has not been processed. As a result, certain edges in the original graph do not appear in the resulting tree. The edges included in this tree are called *forward edges* (or *tree edges*), and the edges not included in this tree are called *back edges* and are shown as dashed lines.

Figure 8.4 illustrates the execution of this algorithm for a digraph. Notice that the original graph results in three spanning trees, although we started with only two isolated subgraphs.

**FIGURE 8.4** The `depthFirstSearch()` algorithm applied to a digraph.



The complexity of `depthFirstSearch()` is  $O(|V| + |E|)$  because (a) initializing  $num(v)$  for each vertex  $v$  requires  $|V|$  steps; (b) `DFS(v)` is called  $deg(v)$  times for each  $v$ —that is, once for each edge of  $v$  (to spawn into more calls or to finish the chain of recursive calls)—hence, the total number of calls is  $2|E|$ ; (c) searching for vertices as required by the statement

```
while there is a vertex  $v$  such that  $num(v)$  is 0
```

can be assumed to require  $|V|$  steps. For a graph with no isolated parts, the loop makes only one iteration, and an initial vertex can be found in one step, although it may take  $|V|$  steps. For a graph with all isolated vertices, the loop iterates  $|V|$  times, and each time a vertex can also be chosen in one step, although in an unfavorable implementation, the  $i$ th iteration may require  $i$  steps, whereby the loop would require  $O(|V|^2)$  steps in total. For example, if an adjacency list is used, then for each  $v$ , the condition in the loop,

```
for all vertices  $u$  adjacent to  $v$ 
```

is checked  $deg(v)$  times. However, if an adjacency matrix is used, then the same condition is used  $|V|$  times, whereby the algorithm's complexity becomes  $O(|V|^2)$ .

As we shall see, many different algorithms are based on `DFS()`; however, some algorithms are more efficient if the underlying graph traversal is not depth first but breadth first. We have already encountered these two types of traversals in Chapter 6; recall that the depth-first algorithms rely on the use of a stack (explicitly, or implicitly, in recursion), and breadth-first traversal uses a queue as the basic data structure. Not surprisingly, this idea can also be extended to graphs, as shown in the following pseudocode:

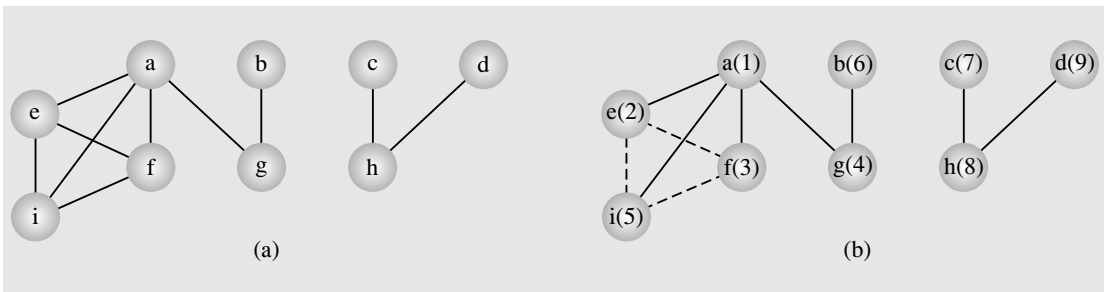
```

breadthFirstSearch()
  for all vertices u
    num(u) = 0;
  edges = null;
  i = 1;
  while there is a vertex v such that num(v) == 0
    num(v)=i++;
    enqueue(v);
    while queue is not empty
      v = dequeue();
      for all vertices u adjacent to v
        if num(u) is 0
          num(u) = i++;
          enqueue(u);
          attach edge(vu) to edges;
  output edges;

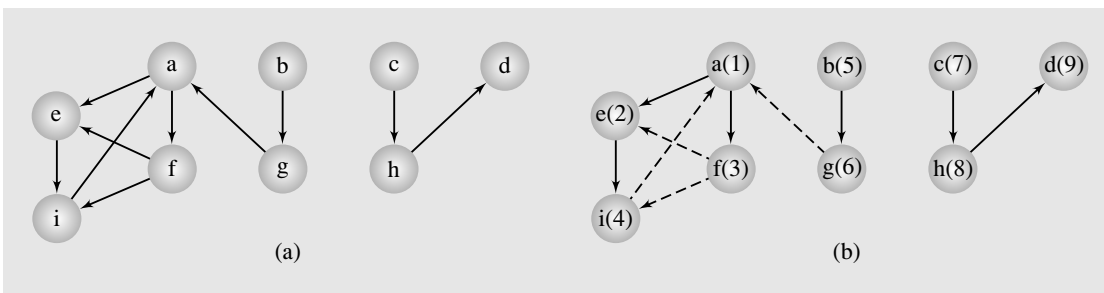
```

Examples of processing a simple graph and a digraph are shown in Figures 8.5 and 8.6. `breadthFirstSearch()` first tries to mark all neighbors of a vertex  $v$  before proceeding to other vertices, whereas `DFS()` picks one neighbor of a  $v$  and then proceeds to a neighbor of this neighbor before processing any other neighbors of  $v$ .

**FIGURE 8.5** An example of application of the `breadthFirstSearch()` algorithm to a graph.



**FIGURE 8.6** The `breadthFirstSearch()` algorithm applied to a digraph.





## 8.3 SHORTEST PATHS

Finding the shortest path is a classical problem in graph theory, and a large number of different solutions have been proposed. Edges are assigned certain weights representing, for example, distances between cities, times separating the execution of certain tasks, costs of transmitting information between locations, amounts of some substance transported from one place to another, and so on. When determining the shortest path from vertex  $v$  to vertex  $u$ , information about distances between intermediate vertices  $w$  has to be recorded. This information can be recorded as a label associated with these vertices, where the label is only the distance from  $v$  to  $w$  or the distance along with the predecessor of  $w$  in this path. The methods of finding the shortest path rely on these labels. Depending on how many times these labels are updated, the methods solving the shortest path problem are divided in two classes: label-setting methods and label-correcting methods.

For *label-setting methods*, in each pass through the vertices still to be processed, one vertex is set to a value that remains unchanged to the end of the execution. This, however, limits such methods to processing graphs with only positive weights. The second category includes *label-correcting methods*, which allow for the changing of *any* label during application of the method. The latter methods can be applied to graphs with negative weights and with no *negative cycle*—a cycle composed of edges with weights adding up to a negative number—but they guarantee that, for all vertices, the current distances indicate the shortest path only after the processing of the graph is finished. Most of the label-setting and label-correcting methods, however, can be subsumed to the same form, which allows finding the shortest paths from one vertex to all other vertices (Gallo and Pallottino, 1986):

```
genericShortestPathAlgorithm(weighted simple digraph, vertex first)
  for all vertices  $v$ 
     $currDist(v) = \infty$ ;
   $currDist(first) = 0$ ;
  initialize toBeChecked;
  while toBeChecked is not empty
     $v =$  a vertex in toBeChecked;
    remove  $v$  from toBeChecked;
    for all vertices  $u$  adjacent to  $v$ 
      if  $currDist(u) > currDist(v) + weight(edge(vu))$ 
         $currDist(u) = currDist(v) + weight(edge(vu))$ ;
         $predecessor(u) = v$ ;
        add  $u$  to toBeChecked if it is not there;
```

In this generic algorithm, a label consists of two elements:

$$label(v) = (currDist(v), predecessor(v))$$

This algorithm leaves two things open: the organization of the set *toBeChecked* and the order of assigning new values to  $v$  in the assignment statement

```
 $v =$  a vertex in toBeChecked;
```

It should be clear that the organization of `toBeChecked` can determine the order of choosing new values for  $v$ , but it also determines the efficiency of the algorithm.

What distinguishes label-setting methods from label-correcting methods is the method of choosing the value for  $v$ , which is always a vertex in `toBeChecked` with the smallest current distance. One of the first label-setting algorithms was developed by Dijkstra.

In Dijkstra's algorithm, a number of paths  $p_1, \dots, p_n$  from a vertex  $v$  are tried, and each time, the shortest path is chosen among them, which may mean that the same path  $p_i$  can be continued by adding one more edge to it. But if  $p_i$  turns out to be longer than any other path that can be tried,  $p_i$  is abandoned and this other path is tried by resuming from where it was left and by adding one more edge to it. Because paths can lead to vertices with more than one outgoing edge, new paths for possible exploration are added for each outgoing edge. Each vertex is tried once, all paths leading from it are opened, and the vertex itself is put away and not used anymore. After all vertices are visited, the algorithm is finished. Dijkstra's algorithm is as follows:

```
DijkstraAlgorithm(weighted simple digraph, vertex first)
  for all vertices  $v$ 
    currDist( $v$ ) =  $\infty$ ;
  currDist(first) = 0;
  toBeChecked = all vertices;
  while toBeChecked is not empty
     $v$  = a vertex in toBeChecked with minimal currDist( $v$ );
    remove  $v$  from toBeChecked;
    for all vertices  $u$  adjacent to  $v$  and in toBeChecked
      if currDist( $u$ ) > currDist( $v$ ) + weight(edge( $v$ u))
        currDist( $u$ ) = currDist( $v$ ) + weight(edge( $v$ u));
        predecessor( $u$ ) =  $v$ ;
```

Dijkstra's algorithm is obtained from the generic method by being more specific about which vertex is to be taken from `toBeChecked` so that the line

```
 $v$  = a vertex in toBeChecked;
```

is replaced by the line

```
 $v$  = a vertex in toBeChecked with minimal currDist( $v$ );
```

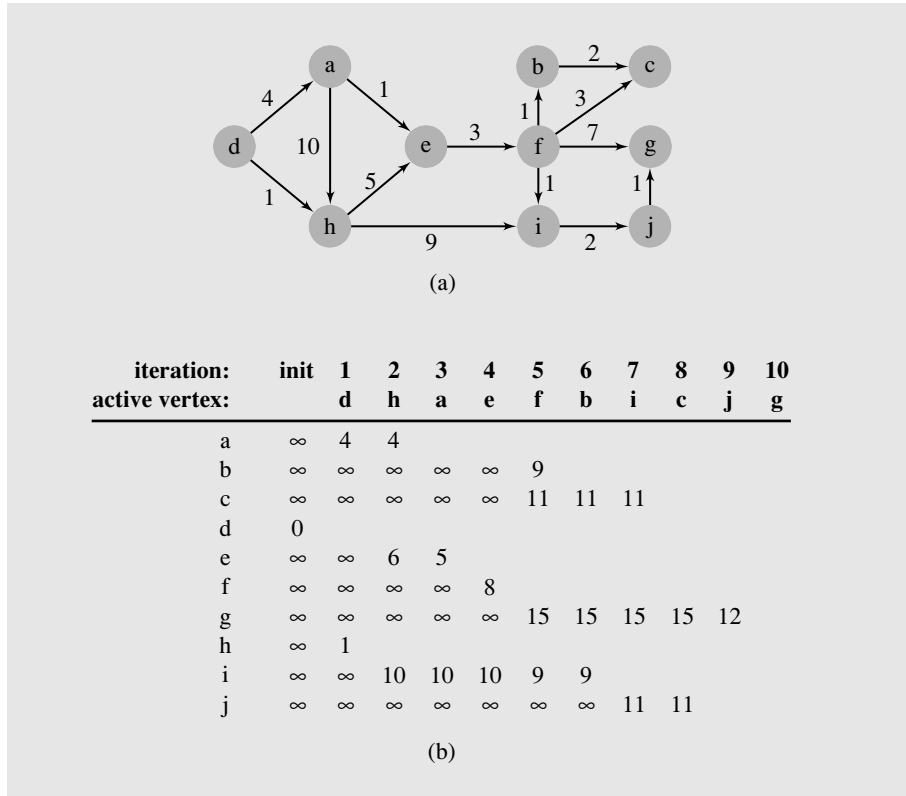
and by extending the condition in the `if` statement whereby the current distance of vertices eliminated from `toBeChecked` is set permanently.<sup>1</sup> Note that the structure of `toBeChecked` is not specified, and the efficiency of the algorithms depends on the data type of `toBeChecked`, which determines how quickly a vertex with minimal distance can be retrieved.

Figure 8.7 contains an example. The table in this figure shows all iterations of the `while` loop. There are 10 iterations because there are 10 vertices. The table indicates the current distances determined up until the current iteration.

---

<sup>1</sup>Dijkstra used six sets to ensure this condition, three for vertices and three for edges.

**FIGURE 8.7** An execution of `DijkstraAlgorithm()`.



The list `toBeChecked` is initialized to  $\{a b \dots j\}$ ; the current distances of all vertices are initialized to a very large value, marked here as  $\infty$ ; and in the first iteration, the current distances of  $d$ 's neighbors are set to numbers equal to the weights of the edges from  $d$ . Now, there are two candidates for the next try,  $a$  and  $h$ , because  $d$  was excluded from `toBeChecked`. In the second iteration,  $h$  is chosen, because its current distance is minimal, and then the two vertices accessible from  $h$ , namely,  $e$  and  $i$ , acquire the current distances 6 and 10. Now, there are three candidates in `toBeChecked` for the next try,  $a$ ,  $e$ , and  $i$ .  $a$  has the smallest current distance, so it is chosen in the third iteration. Eventually, in the tenth iteration, `toBeChecked` becomes empty and the execution of the algorithm completes.

The complexity of Dijkstra's algorithm is  $O(|V|^2)$ . The first `for` loop and the `while` loop are executed  $|V|$  times. For each iteration of the `while` loop, (a) a vertex  $v$  in `toBeChecked` with minimal current distance has to be found, which requires  $O(|V|)$  steps, and (b) the `for` loop iterates  $deg(v)$  times, which is also  $O(|V|)$ . The efficiency can be improved by using a heap to store and order vertices and adjacency lists (Johnson 1977). Using a heap turns the complexity of this algorithm into  $O(|E| + |V| \lg |V|)$ ; each time through the `while` loop, the cost of restoring the heap after

removing a vertex is proportional to  $O(\lg|V|)$ . Also, in each iteration, only adjacent vertices are updated on an adjacency list so that the total updates for all vertices considered in all iterations are proportional to  $|E|$ , and each list update corresponds to the cost of  $\lg|V|$  of the heap update.

Dijkstra's algorithm is not general enough in that it may fail when negative weights are used in graphs. To see why, change the weight of  $edge(ah)$  from 10 to  $-10$ . Note that the path  $d, a, h, e$  is now  $-1$ , whereas the path  $d, a, e$  as determined by the algorithm is 5. The reason for overlooking this less costly path is that the vertices with the current distance set from  $\infty$  to a value are not checked anymore: First, successors of vertex  $d$  are scrutinized and  $d$  is removed from `toBeChecked`, then the vertex  $h$  is removed from `toBeChecked`, and only afterward is the vertex  $a$  considered as a candidate to be included in the path from  $d$  to other vertices. But now, the  $edge(ah)$  is not taken into consideration because the condition in the `for` loop prevents the algorithm from doing this. To overcome this limitation, a label-correcting method is needed.

One of the first label-correcting algorithms was devised by Lester Ford. Like Dijkstra's algorithm, it uses the same method of setting current distances, but Ford's method does not permanently determine the shortest distance for any vertex until it processes the entire graph. It is more powerful than Dijkstra's method in that it can process graphs with negative weights (but not graphs with negative cycles).

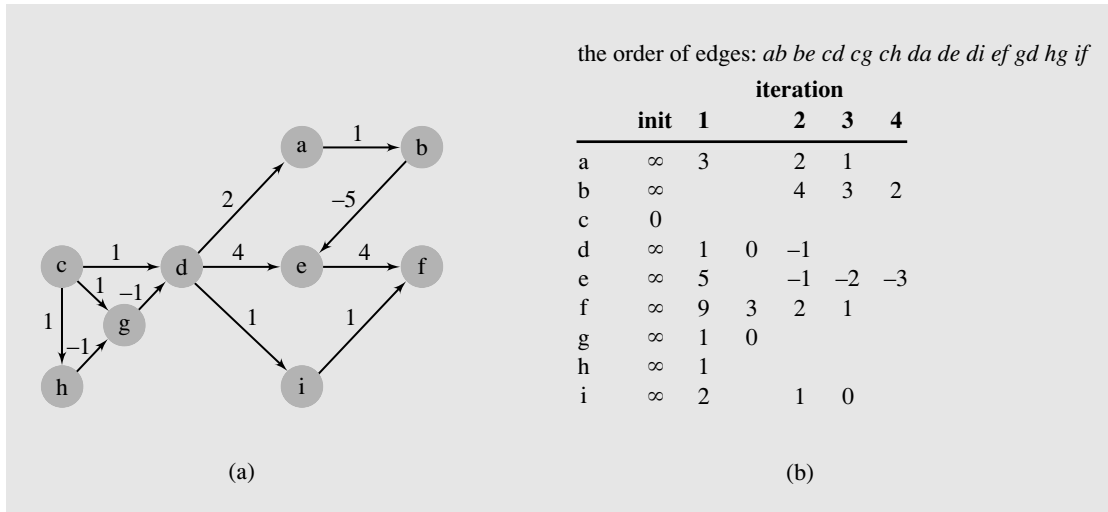
As required by the original form of the algorithm, all edges are monitored to find a possibility for an improvement of the current distance of vertices so that the algorithm can be presented in this pseudocode:

```
FordAlgorithm(weighted simple digraph, vertex first)
  for all vertices v
    currDist(v) =  $\infty$ ;
  currDist(first) = 0;
  while there is an edge (vu) such that currDist(u) > currDist(v) + weight(edge(vu))
    currDist(u) = currDist(v) + weight(edge(vu));
```

To impose a certain order on monitoring the edges, an alphabetically ordered sequence of edges can be used so that the algorithm can repeatedly go through the entire sequence and adjust the current distance of any vertex, if needed. Figure 8.8 contains an example. The graph includes edges with negative weights. The table indicates iterations of the `while` loop and current distances updated in each iteration, where one iteration is defined as one pass through the edges. Note that a vertex can change its current distance during the same iteration. However, at the end, each vertex of the graph can be reached through the shortest path from the starting vertex (vertex  $c$  in the example in Figure 8.8).

The computational complexity of this algorithm is  $O(|V||E|)$ . There will be at most  $|V| - 1$  passes through the sequence of  $|E|$  edges, because  $|V| - 1$  is the largest number of edges in any path. In the first pass, at least all one-edge paths are determined; in the second pass, all two-edge paths are determined; and so on. However, for graphs with irrational weights, this complexity is  $O(2^{|V|})$  (Gallo and Pallottino 1986).

We have seen in the case of Dijkstra's algorithm that the efficiency of an algorithm can be improved by scanning edges and vertices in a certain order, which in turn depends on the data structure used to store them. The same holds true for label-correcting methods. In particular, `FordAlgorithm()` does not specify the order of

**FIGURE 8.8** FordAlgorithm() applied to a digraph with negative weights.

checking edges. In the example illustrated in Figure 8.8, a simple solution is used in that all adjacency lists of all vertices were visited in each iteration. However, in this approach, all the edges are checked every time, which is not necessary, and more judicious organization of the list of vertices can limit the number of visits per vertex. Such an improvement is based on the `genericShortestPathAlgorithm()` by explicitly referring to the `toBeChecked` list, which in `FordAlgorithm()` is used only implicitly: It simply is the set of all vertices  $V$  and remains such for the entire run of the algorithm. This leads us to a general form of a label-correcting algorithm as expressed in this pseudocode:

```

labelCorrectingAlgorithm(weighted simple digraph, vertex first)
  for all vertices v
    currDist(v) =  $\infty$ ;
  currDist(first) = 0;
  toBeChecked = {first};
  while toBeChecked is not empty
    v = a vertex in toBeChecked;
    remove v from toBeChecked;
    for all vertices u adjacent to v
      if currDist(u) > currDist(v) + weight(edge(vu))
        currDist(u) = currDist(v) + weight(edge(vu));
        predecessor(u) = v;
        add u to toBeChecked if it is not there;

```

The efficiency of particular instantiations of this algorithm hinges on the data structure used for the `toBeChecked` list and on operations for extracting elements from this list and including them into it.

One possible organization of this list is a queue: Vertex  $v$  is dequeued from `toBeChecked`, and if the current distance of any of its neighbors,  $u$ , is updated,  $u$  is enqueued onto `toBeChecked`. It seems like a natural choice, and in fact, it was one of the earliest, used in 1968 by C. Witzgall (Deo and Pang, 1984). However, it is not without flaws, as it sometimes reevaluates the same labels more times than necessary. Figure 8.9 contains an example of an excessive reevaluation. The table in this figure shows all changes on `toBeChecked` implemented as a queue when `labelCorrectingAlgorithm()` is applied to the graph in Figure 8.8a. The vertex  $d$  is updated three times. These updates cause three changes to its successors,  $a$  and  $i$ , and two changes to another successor,  $e$ . The change of  $a$  translates into two changes to  $b$  and these into two more changes to  $e$ . To avoid such repetitious updates, a doubly ended queue, or deque, can be used.

**FIGURE 8.9** An execution of `labelCorrectingAlgorithm()`, which uses a queue.

	active vertex																						
queue	c	d	g	h	a	e	i	d	g	b	f	a	e	i	d	b	f	a	i	e	b	f	e
	d	g	h	a	e	i	d	g	b	f	a	e	i	d	b	f	a	i	e	b	f	e	
	g	h	a	e	i	d	g	b	f	a	e	i	d	b	f	a	i	e	b	f	e		
	h	a	e	i	d	g	b	f	a	e	i	d	b	f	a	i	e	b	f				
		e	i	d	g	b	f	a	e	i	d	b			i	e							
			i	d	g	b	f	e	i	d													
								i	d														
a	∞	∞	3	3	3	3	3	2	2	2	2	2	2	2	1								
b	∞	∞	∞	∞	∞	4	4	4	4	4	4	3	3	3	3	3	3	2					
c	0																						
d	∞	1	1	0	0	0	0	0	-1														
e	∞	∞	5	5	5	5	5	4	4	-1	-1	-1	-1	-1	-1	-2	-2	-2	-2	-2	-3		
f	∞	∞	∞	∞	∞	∞	9	3	3	3	3	3	3	2	2	2	2	2	1				
g	∞	1	1	1	0																		
h	∞	1																					
i	∞	∞	2	2	2	2	2	2	1	1	1	1	1	1	1	0							

The choice of a deque as a solution to this problem is attributed to D. D’Esopo (Pollack and Wiebenson, 1960) and was implemented by Pape. In this method, the vertices included in `toBeChecked` for the first time are put at the end of the list; otherwise, they are added at the front. The rationale for this procedure is that if a vertex  $v$  is included for the first time, then there is a good chance that the vertices accessible from  $v$  have not been processed yet, so they will be processed after processing  $v$ . On the other hand, if  $v$  has been processed at least once, then it is likely that the vertices reachable from  $v$  are still on the list waiting for processing; by putting  $v$  at the end of the list, these vertices may very likely be reprocessed due to the update of `currDist(v)`. Therefore, it is better to put  $v$  in front of their successors to avoid an unnecessary round of updates. Figure 8.10 shows changes in the deque during the execution of

**FIGURE 8.10** An execution of `labelCorrectingAlgorithm()`, which applies a deque.

		active vertex											
	c	d	g	d	h	g	d	a	e	i	b	e	f
deque	d	g	d	h	g	d	a	e	i	b	e	f	
	g	h	h	a	a	a	e	i	b	f	f		
	h	a	a	e	e	e	i	b	f				
		e	e	i	i	i							
		i	i										
a	$\infty$	$\infty$	3	3	2	2	2	1					
b	$\infty$	$\infty$	$\infty$	$\infty$	$\infty$	$\infty$	$\infty$	$\infty$	2				
c	0												
d	$\infty$	1	1	0	0	0	-1						
e	$\infty$	$\infty$	5	5	4	4	4	3	3	3	3	-3	
f	$\infty$	$\infty$	$\infty$	$\infty$	$\infty$	$\infty$	$\infty$	$\infty$	$\infty$	7	1		
g	$\infty$	1	1	1	1	0							
h	$\infty$	1											
i	$\infty$	$\infty$	2	2	1	1	1	0					

`labelCorrectingAlgorithm()` applied to the graph in Figure 8.8a. This time, the number of iterations is dramatically reduced. Although  $d$  is again evaluated three times, these evaluations are performed before processing its successors so that  $a$  and  $i$  are processed once and  $e$  twice. However, this algorithm has a problem of its own because in the worst case its performance is an exponential function of the number of vertices. (See Exercise 13 at the end of this chapter.) But in the average case, as Pape's experimental runs indicate, this implementation fares at least 60 percent better than the previous queue solution.

Instead of using a deque, which combines two queues, the two queues can be used separately. In this version of the algorithm, vertices stored for the first time are enqueued on `queue1`, and on `queue2` otherwise. Vertices are dequeued from `queue1` if it is not empty, and from `queue2` otherwise (Gallo and Pallottino, 1988).

Another version of the label-correcting method is the *threshold algorithm*, which also uses two lists. Vertices are taken for processing from `list1`. A vertex is added to the end of `list1` if its label is below the current threshold level, and to `list2` otherwise. If `list1` is empty, then the threshold level is changed to a value greater than a minimum label among the labels of the vertices in `list2`, and then the vertices with the label values below the threshold are moved to `list1` (Glover, Glover, and Klingman, 1984).

Still another algorithm is a *small label first* method. In this method, a vertex is included at the front of a deque if its label is smaller than the label at the front of the deque; otherwise, it is put at the end of the deque (Bertsekas, 1993). To some extent, this method includes the main criterion of label-setting methods. The latter methods always retrieve the minimal element from the list; the small label first method puts a vertex with the label smaller than the label of the front vertex at the top. The approach

can be carried to its logical conclusion by requiring each vertex to be included in the list according to its rank so that the deque turns into a priority queue and the resulting method becomes a label-correcting version of Dijkstra's algorithm.

### 8.3.1 All-to-All Shortest Path Problem

Although the task of finding all shortest paths from any vertex to any other vertex seems to be more complicated than the task of dealing with one source only, a method designed by Stephen Warshall and implemented by Robert W. Floyd and P. Z. Ingerman does it in a surprisingly simple way, provided an adjacency matrix is given that indicates all the edge weights of the graph (or digraph). The graph can include negative weights. The algorithm is as follows:

```

WFIAalgorithm(matrix weight)
  for i = 1 to |V|
    for j = 1 to |V|
      for k = 1 to |V|
        if weight[j][k] > weight[j][i] + weight[i][k]
          weight[j][k] = weight[j][i] + weight[i][k];

```

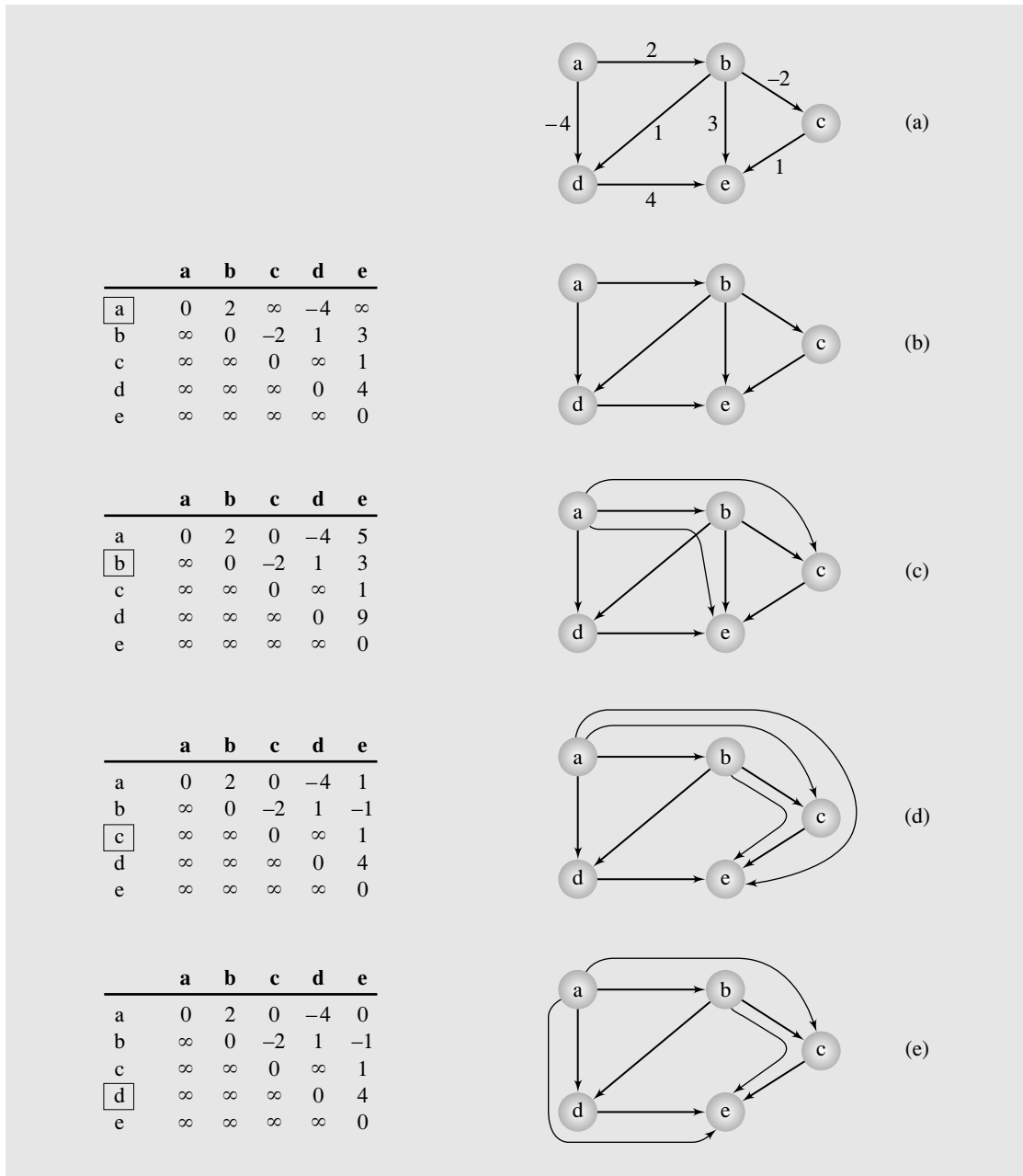
The outermost loop refers to vertices that may be on a path between the vertex with index  $j$  and the vertex with index  $k$ . For example, in the first iteration, when  $i = 1$ , all paths  $v_j \dots v_1 \dots v_k$  are considered, and if there is currently no path from  $v_j$  to  $v_k$  and  $v_k$  is reachable from  $v_j$ , the path is established, with its weight equal to  $p = \text{weight}(\text{path}(v_j, v_1)) + \text{weight}(\text{path}(v_1, v_k))$ , or the current weight of this path,  $\text{weight}(\text{path}(v_j, v_k))$ , is changed to  $p$  if  $p$  is less than  $\text{weight}(\text{path}(v_j, v_k))$ . As an example, consider the graph and the corresponding adjacency matrix in Figure 8.11. This figure also contains tables that show changes in the matrix for each value of  $i$  and the changes in paths as established by the algorithm. After the first iteration, the matrix and the graph remain the same, because  $a$  has no incoming edges (Figure 8.11a). They also remain the same in the last iteration, when  $i = 5$ ; no change is introduced to the matrix because vertex  $e$  has no outgoing edges. A better path, one with a lower combined weight, is always chosen, if possible. For example, the direct one-edge path from  $b$  to  $e$  in Figure 8.11c is abandoned after a two-edge path from  $b$  to  $e$  is found with a lower weight, as in Figure 8.11d.

This algorithm also allows us to detect cycles if the diagonal is initialized to  $\infty$  and not to zero. If any of the diagonal values are changed, then the graph contains a cycle. Also, if an initial value of  $\infty$  between two vertices in the matrix is not changed to a finite value, it is an indication that one vertex cannot be reached from another.

The simplicity of the algorithm is reflected in the ease with which its complexity can be computed: All three `for` loops are executed  $|V|$  times, so its complexity is  $|V|^3$ . This is a good efficiency for dense, nearly complete graphs, but in sparse graphs, there is no need to check for all possible connections between vertices. For sparse graphs, it may be more beneficial to use a one-to-all method  $|V|$  times—that is, apply it to each vertex separately. This should be a label-setting algorithm, which as a rule has better complexity than a label-correcting algorithm. However, a label-setting algorithm cannot work with graphs with negative weights. To solve this problem, we have to modify



**FIGURE 8.11** An execution of `WFAlgorithm()`.



the graph so that it does not have negative weights and it guarantees to have the same shortest paths as the original graph. Fortunately, such a modification is possible (Edmonds and Karp, 1972).

Observe first that, for any vertex  $v$ , the length of the shortest path to  $v$  is never greater than the length of the shortest path to any of its predecessors  $w$  plus the length of edge from  $w$  to  $v$ , or

$$\text{dist}(v) \leq \text{dist}(w) + \text{weight}(\text{edge}(wv))$$

for any vertices  $v$  and  $w$ . This inequality is equivalent to the inequality

$$0 \leq \text{weight}'(\text{edge}(wv)) = \text{weight}(\text{edge}(wv)) + \text{dist}(w) - \text{dist}(v)$$

Hence, changing  $\text{weight}(e)$  to  $\text{weight}'(e)$  for all edges  $e$  renders a graph with nonnegative edge weights. Now note that the shortest path  $v_1, v_2, \dots, v_k$  is

$$\sum_{i=1}^{k-1} \text{weight}'(\text{edge}(v_i v_{i+1})) = \left( \sum_{i=1}^{k-1} \text{weight}(\text{edge}(v_i v_{i+1})) \right) + \text{dist}(v_1) - \text{dist}(v_k)$$

Therefore, if the length  $L'$  of the path from  $v_1$  to  $v_k$  is found in terms of nonnegative weights, then the length  $L$  of the same path in the same graph using the original weights, some possibly negative, is  $L = L' - \text{dist}(v_1) + \text{dist}(v_k)$ .

But because the shortest paths have to be known to make such a transformation, the graph has to be preprocessed by one application of a label-correcting method. Only afterward are the weights modified, and then a label-setting method is applied  $|V|$  times.

## 8.4 CYCLE DETECTION

Many algorithms rely on detecting cycles in graphs. We have just seen that, as a side effect, `WFIAlgorithm()` allows for detecting cycles in graphs. However, it is a cubic algorithm, which in many situations is too inefficient. Therefore, other cycle detection methods have to be explored.

One such algorithm is obtained directly from `depthFirstSearch()`. For undirected graphs, small modifications in `DFS(v)` are needed to detect cycles and report them

```

cycleDetectionDFS(v)
    num(v) = i++;
    for all vertices u adjacent to v
        if num(u) is 0
            attach edge(uv) to edges;
            cycleDetectionDFS(u);
        else if edge(vu) is not in edges
            cycle detected;

```

For digraphs, the situation is a bit more complicated, because there may be edges between different spanning subtrees, called *side edges* (see *edge(ga)* in Figure 8.4b). An edge (a back edge) indicates a cycle if it joins two vertices already included in the same

spanning subtree. To consider only this case, a number higher than any number generated in subsequent searches is assigned to a vertex being currently visited after all its descendants have also been visited. In this way, if a vertex is about to be joined by an edge with a vertex having a lower number, we declare a cycle detection. The algorithm is now

```
digraphCycleDetectionDFS(v)
    num(v) = i++;
    for all vertices u adjacent to v
        if num(u) is 0
            pred(u) = v;
            digraphCycleDetectionDFS(u);
        else if num(u) is not ∞
            pred(u) = v;
            cycle detected;
    num(v) = ∞;
```

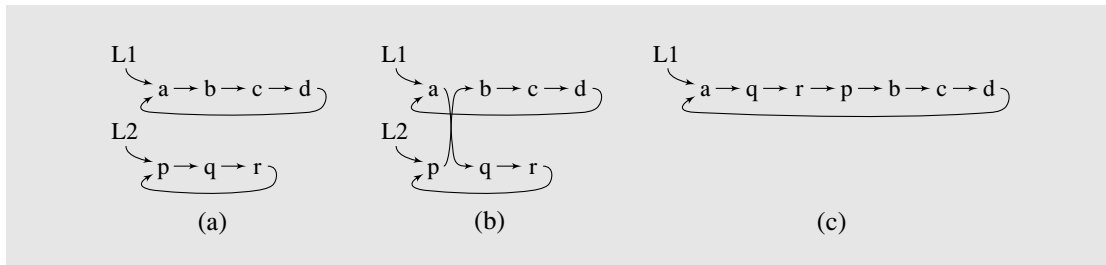
### 8.4.1 Union-Find Problem

Let us recall from a preceding section that depth-first search guaranteed generating a spanning tree in which no element of `edges` used by `depthFirstSearch()` led to a cycle with other elements of `edges`. This was due to the fact that if vertices  $v$  and  $u$  belonged to `edges`, then the `edge(vu)` was disregarded by `depthFirstSearch()`. A problem arises when `depthFirstSearch()` is modified so that it can detect whether a specific `edge(vu)` is part of a cycle (see Exercise 20). Should such a modified depth-first search be applied to each edge separately, then the total run would be  $O(|E|(|E| + |V|))$ , which could turn into  $O(|V|^4)$  for dense graphs. Hence, a better method needs to be found.

The task is to determine if two vertices are in the same set. Two operations are needed to implement this task: finding the set to which a vertex  $v$  belongs and uniting two sets into one if vertex  $v$  belongs to one of them and  $w$  to another. This is known as the *union-find problem*.

The sets used to solve the union-find problem are implemented with circular linked lists; each list is identified by a vertex that is the root of the tree to which the vertices in the list belong. But first, all vertices are numbered with integers  $0, \dots, |V| - 1$ , which are used as indexes in three arrays: `root[]` to store a vertex index identifying a set of vertices, `next[]` to indicate the next vertex on a list, and `length[]` to indicate the number of vertices in a list.

We use circular lists to be able to combine two lists right away, as illustrated in Figure 8.12. Lists L1 and L2 (Figure 8.12a) are merged into one by interchanging `next` references in both lists (Figure 8.12b or, the same list, Figure 8.12c). However, the vertices in L2 have to “know” to which list they belong; therefore, their root indicators have to be changed to the new root. Because it has to be done for all vertices of list L2, then L2 should be the shorter of the two lists. To determine the length of lists, the third array is used, `length[]`, but only lengths for the identifying nodes (roots) have to be updated. Therefore, the lengths indicated for other vertices that were roots (and at the beginning each of them was) are disregarded.

**FIGURE 8.12** Concatenating two circular linked lists.

The union operation performs all the necessary tasks, so the find operation becomes trivial. By constantly updating the array `root[]`, the set, to which a vertex  $j$  belongs, can be immediately identified, because it is a set whose identifying vertex is `root[j]`. Now, after the necessary initializations,

```
initialize()
  for i = 0 to |V| - 1
    root[i] = next[i] = i;
    length[i] = 1;
```

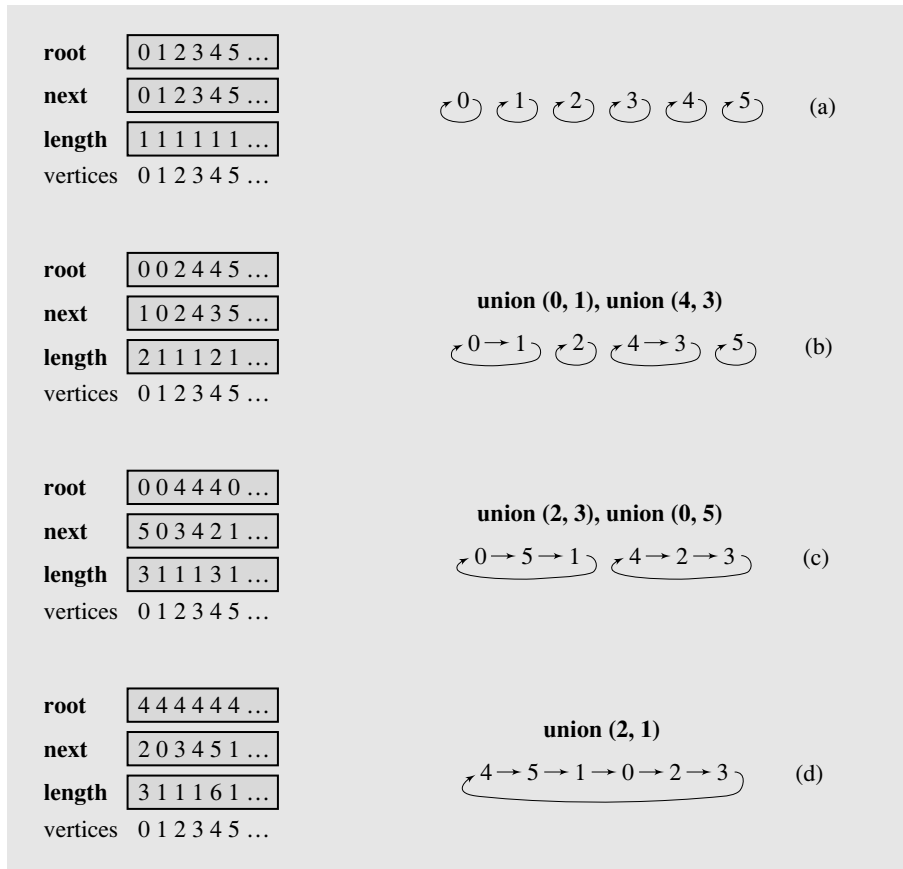
`union()` can be defined as follows:

```
union(edge(vu))
  if (root[u] == root[v]) // disregard this edge,
    return; // since v and u are in
  else if (length[root[v]] < length[root[u]]) // the same set; combine
    rt = root[v]; // two sets into one;
    length[root[u]] += length[rt];
    root[rt] = root[u]; // update root of rt and
  for (j = next[rt]; j != rt; j = next[j]) // then other vertices
    root[j] = root[u]; // in circular list;
  swap(next[rt], next[root[u]]); // merge two lists;
  add edge(vu) to spanningTree;
  else // if length[root[v]] >= length[root[u]]
    // proceed as before, with v and u reversed;
```

An example of the application of `union()` to merge lists is shown in Figure 8.13. After initialization, there are  $|V|$  unary sets or one-node linked lists, as in Figure 8.13a. After executing `union()` several times, smaller linked lists are merged into larger ones, and each time, the new situation is reflected in the three arrays, as shown in Figures 8.13b–d.

The complexity of `union()` depends on the number of vertices that have to be updated when merging two lists, specifically, on the number of vertices on the shorter list, because this number determines how many times the `for` loop in `union()` iterates. Because this number can be between 1 and  $|V|/2$ , the complexity of `union()` is given by  $O(|V|)$ .

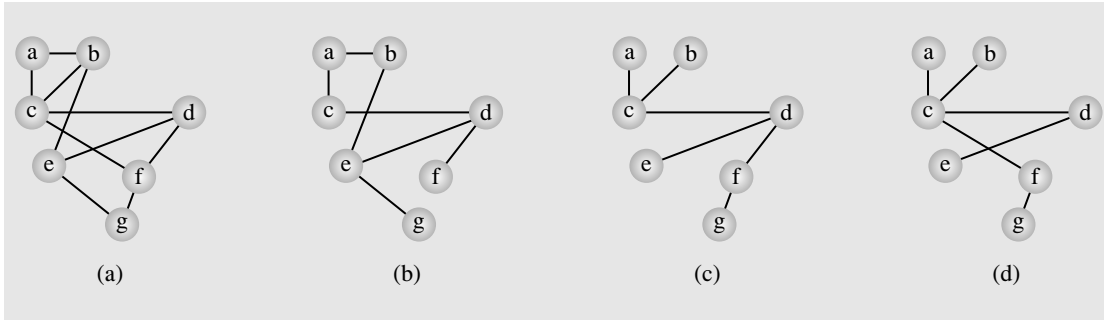
**FIGURE 8.13** An example of application of `union()` to merge lists.



## 8.5 SPANNING TREES

Consider the graph representing the airline’s connections between seven cities (Figure 8.14a). If the economic situation forces this airline to shut down as many connections as possible, which of them should be retained to make sure that it is still possible to reach any city from any other city, if only indirectly? One possibility is the graph in Figure 8.14b. City *a* can be reached from city *d* using the path *d, c, a*, but it is also possible to use the path *d, e, b, a*. Because the number of retained connections is the issue, there is still the possibility we can reduce this number. It should be clear that the minimum number of such connections form a tree because alternate paths arise as a result of cycles in the graph. Hence, to create the minimum number of connections, a spanning tree should be created, and such a spanning tree is the by-product of `depthFirstSearch()`. Clearly, we can create different spanning trees

**FIGURE 8.14** A graph representing (a) the airline connections between seven cities and (b–d) three possible sets of connections.



(Figures 8.14c–d)—that is, we can decide to retain different sets of connections—but all these trees have six edges and we cannot do any better than that.

The solution to this problem is not optimal in that the distances between cities have not been taken into account. Because there are alternative six-edge connections between cities, the airline uses the cost of these connections to choose the best, guaranteeing the optimum cost. This can be achieved by having maximally short distances for the six connections. This problem can now be phrased as finding a *minimum spanning tree*, which is a spanning tree in which the sum of the weights of its edges is minimal. The previous problem of finding a spanning tree in a simple graph is a case of the minimum spanning tree problem in that the weights for each edge are assumed to equal one. Therefore, each spanning tree is a minimum tree in a simple graph.

The minimum spanning tree problem has many solutions, and only a handful of them are presented here. (For a review of these methods, see Graham and Hell 1985.)

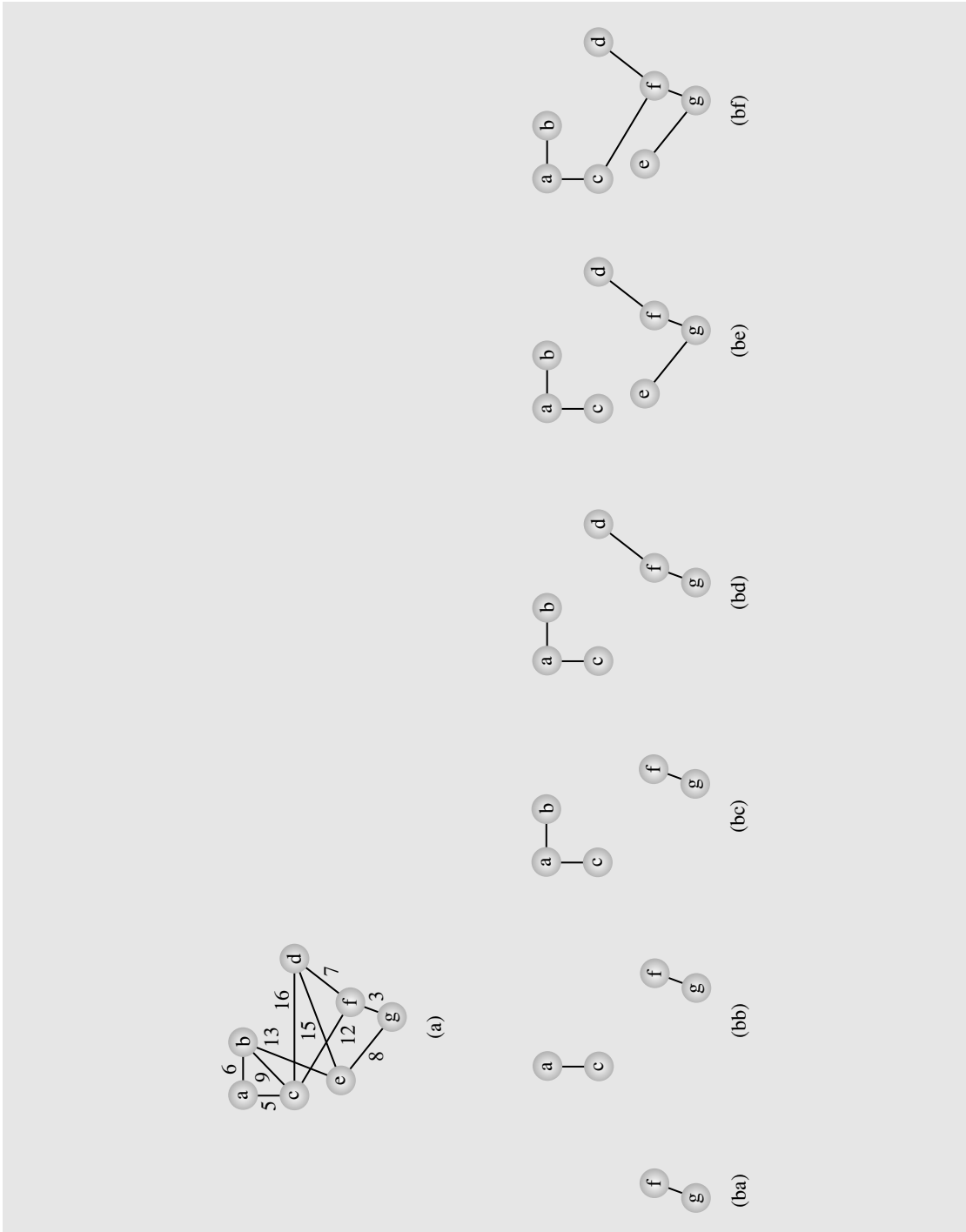
One popular algorithm was devised by Joseph Kruskal. In this method, all edges are ordered by weight, and then each edge in this ordered sequence is checked to see whether it can be considered part of the tree under construction. It is added to the tree if no cycle arises after its inclusion. This simple algorithm can be summarized as follows:

```
KruskalAlgorithm(weighted connected undirected graph)
  tree = null;
  edges = sequence of all edges of graph sorted by weight;
  for (i = 1; i ≤ |E| and |tree| < |V| - 1; i++)
    if ei from edges does not form a cycle with edges in tree
      add ei to tree;
```

Figures 8.15ba–bf contain a step-by-step example of Kruskal’s algorithm.

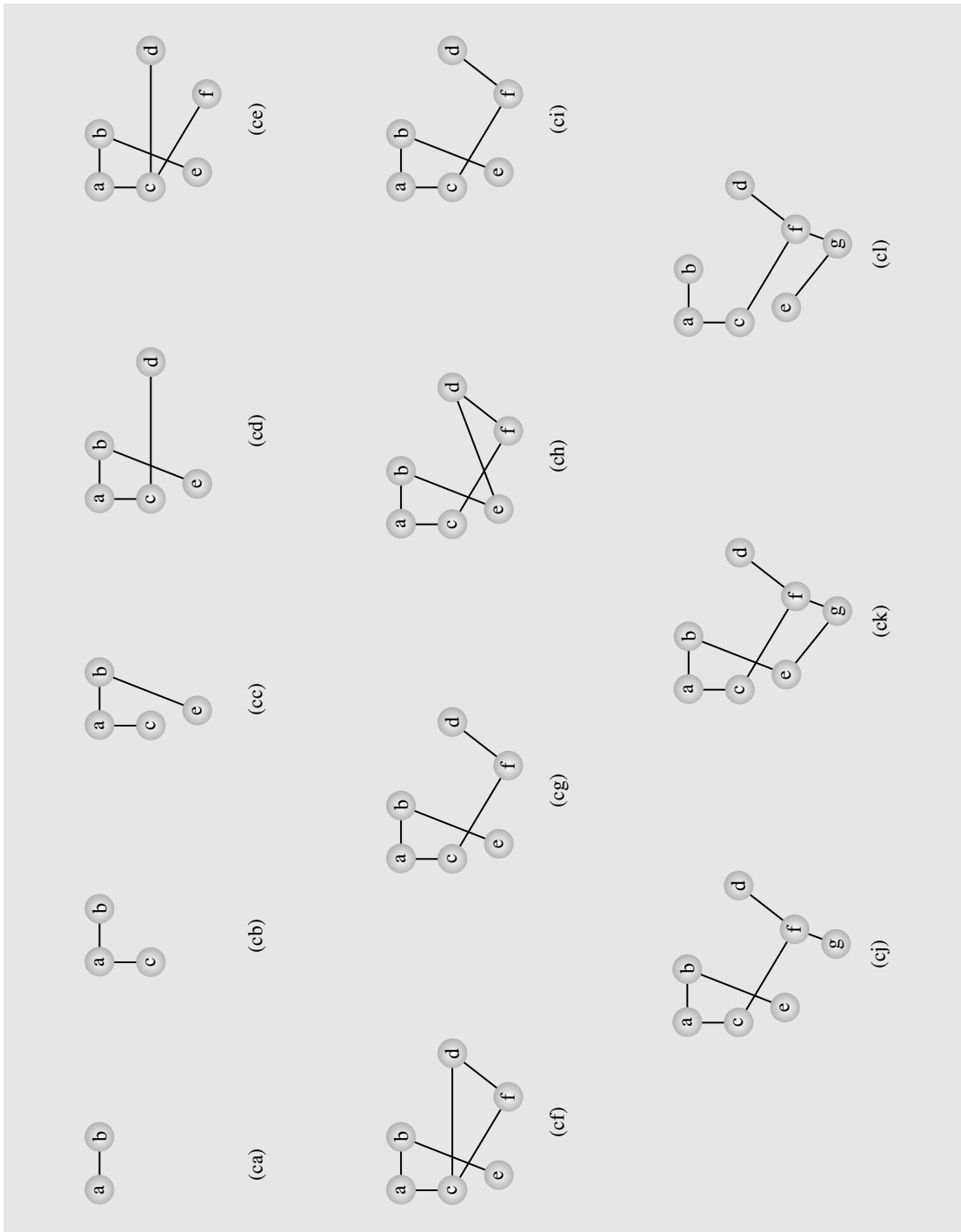
The complexity of this algorithm is determined by the complexity of the sorting method applied, which for an efficient sorting is  $O(|E| \lg |E|)$ . It also depends on the complexity of the method used for cycle detection. If we use `union()` to implement Kruskal’s algorithm, then the `for` loop of `KruskalAlgorithm()` becomes

**FIGURE 8.15** A spanning tree of graph (a) found, (ba–bf) with Kruskal’s algorithm, (ca–cl) and with Dijkstra’s method.



Continues

**FIGURE 8.15** (continued)





```

for (i = 1; i ≤ |E| and |tree| < |V| - 1; i++)
    union(ei = edge(vu));

```

Although `union()` can be called up to  $|E|$  times, it is exited after one (the first) test if a cycle is detected and it performs a union, which is of complexity  $O(|V|)$ , only for  $|V| - 1$  edges added to `tree`. Hence, the complexity of `KruskalAlgorithm()`'s for loop is  $O(|E| + (|V| - 1)|V|)$ , which is  $O(|V|^2)$ . Therefore, the complexity of `KruskalAlgorithm()` is determined by the complexity of a sorting algorithm, which is  $O(|E|\lg|E|)$ , that is,  $O(|E|\lg|V|)$ .

Kruskal's algorithm requires that all the edges be ordered before beginning to build the spanning tree. This, however, is not necessary; it is possible to build a spanning tree by using any order of edges. A method was proposed by Dijkstra (1960) and independently by Robert Kalaba, and because no particular order of edges is required here, their method is more general than the other two.

```

DijkstraMethod(weighted connected undirected graph)
    tree = null;
    edges = an unsorted sequence of all edges of graph;
    for j = 1 to |E|
        add ej to tree;
        if there is a cycle in tree
            remove an edge with maximum weight from this only cycle;

```

In this algorithm, the tree is being expanded by adding to it edges one by one, and if a cycle is detected, then an edge in this cycle with maximum weight is discarded. An example of building the minimum spanning tree with this method is shown in Figures 8.15ca–cl.

To deal with cycles, `DijkstraMethod()` can use a modified version of `union()`. In the modified version, an additional array, `prior`, is used to enable immediate detaching of a vertex from a linked list. Also, each vertex should have a field `next` so that an edge with the maximum weight can be found when checking all the edges in a cycle. With these modifications, the algorithm runs in  $O(|E||V|)$  time.

## 8.6 CONNECTIVITY

In many problems, we are interested in finding a path in the graph from one vertex to any other vertex. For undirected graphs, this means that there are no separate pieces, or subgraphs, of the graph; for a digraph, it means that there are some places in the graph to which we can get from some directions but are not necessarily able to return to the starting points.

### 8.6.1 Connectivity in Undirected Graphs

An undirected graph is called *connected* when there is a path between any two vertices of the graph. The depth-first search algorithm can be used for recognizing whether a graph is connected provided that the loop heading

```

while there is a vertex v such that num(v) == 0

```

is removed. Then, after the algorithm is finished, we have to check whether the list *edges* includes all vertices of the graph or simply check if *i* is equal to the number of vertices.

Connectivity comes in degrees: A graph can be more or less connected, and it depends on the number of different paths between its vertices. A graph is called *n-connected* if there are at least *n* different paths between any two vertices; that is, there are *n* paths between any two vertices that have no vertices in common. A special type of graph is a *2-connected*, or *biconnected*, graph for which there are at least two nonoverlapping paths between any two vertices. A graph is not biconnected if a vertex can be found that always has to be included in the path between at least two vertices *a* and *b*. In other words, if this vertex is removed from the graph (along with incident edges), then there is no way to find a path from *a* to *b*, which means that the graph is split into two separate subgraphs. Such vertices are called *articulation points*, or *cut-vertices*. Vertices *a* and *b* in Figure 8.1d are examples of articulation points. If an edge causes a graph to be split into two subgraphs, it is called a *bridge* or *cut-edge*, as for example, the *edge(bc)* in Figure 8.1d. Connected subgraphs with no articulation points or bridges are called *blocks*, or—when they include at least two vertices—*biconnected components*. It is important to know how to decompose a graph into biconnected components.

Articulation points can be detected by extending the depth-first search algorithm. This algorithm creates a tree with forward edges (the graph edges included in the tree) and back edges (the edges not included). A vertex *v* in this tree is an articulation point if it has at least one subtree unconnected with any of its predecessors by a back edge; because it is a tree, certainly none of *v*'s predecessors is reachable from any of its successors by a forward link. For example, the graph in Figure 8.16a is transformed into a depth-first search tree (Figure 8.16c), and this tree has four articulation points, *b*, *d*, *h*, and *i*, because there is no back edge from any node below *d* to any node above it in the tree, and no back edge from any vertex in the right subtree of *h* to any vertex above *h*. But vertex *g* cannot be an articulation point because its successor *h* is connected to a vertex above it. The four vertices divide the graph into the five blocks indicated in Figure 8.16c by dotted lines.

A special case for an articulation point is when a vertex is a root with more than one descendant. In Figure 8.16a, the vertex chosen for the root, *a*, has three incident edges, but only one of them becomes a forward edge in Figures 8.16b and 8.16c, because the other two are processed by depth-first search. Therefore, if this algorithm again recursively reaches *a*, there is no untried edge. If *a* were an articulation point, there would be at least one such untried edge, and this indicates that *a* is a cut vertex. So *a* is not an articulation point. To sum up, we say that a vertex *v* is an articulation point

1. if *v* is the root of the depth-first search tree and *v* has more than one descendant in this tree or
2. if at least one of *v*'s subtrees includes no vertex connected by a back edge with any of *v*'s predecessors.

To find articulation points, a parameter *pred(v)* is used, defined as  $\min(\text{num}(v), \text{num}(u_1), \dots, \text{num}(u_k))$ , where  $u_1, \dots, u_k$  are vertices connected by a back edge with a descendant of *v* or with *v* itself. Because the higher a predecessor of *v* is, the lower its number is, choosing a minimum number means choosing the highest predecessor. For the tree in Figure 8.16c,  $\text{pred}(c) = \text{pred}(d) = 1$ ,  $\text{pred}(b) = 4$ , and  $\text{pred}(k) = 7$ .



The algorithm uses a stack to store all currently processed edges. After an articulation point is identified, the edges corresponding to a block of the graph are output. The algorithm is given as follows:

```

blockDFS(v)
  pred(v) = num(v) = i++;
  for all vertices u adjacent to v
    if edge(uv) has not been processed
      push(edge(uv));
    if num(u) is 0
      blockDFS(u);
      if pred(u) ≥ num(v) // if there is no edge from u to a
        e = pop(); // vertex above v, output a block
        while e / edge(vu) // by popping all edges off the
          output e; // stack until edge(vu) is
          e = pop(); // popped off;
          output e; // e == edge(vu);
        else pred(v) = min(pred(v), pred(u)); // take a predecessor higher up in
      else if u is not the parent of v // tree;
        pred(v) = min(pred(v), num(u)); // update when back edge(vu) is
        // found;

blockSearch()
  for all vertices v
    num(v) = 0;
  i = 1;
  while there is a vertex v such that num(v) == 0
    blockDFS(v);

```

An example of the execution of this algorithm is shown in Figure 8.16d as applied to the graph in Figure 8.16a. The table lists all changes in  $pred(v)$  for vertices  $v$  processed by the algorithm, and the arrows show the source of the new values of  $pred(v)$ . For each vertex  $v$ , `blockDFS(v)` first assigns two numbers:  $num(v)$ , shown in italics, and  $pred(v)$ , which may change during the execution of `blockDFS(v)`. For example,  $a$  is processed first with  $num(a)$  and  $pred(a)$  set to 1. The  $edge(ac)$  is pushed onto the stack, and because  $num(c)$  is 0, the algorithm is invoked for  $c$ . At this point,  $num(c)$  and  $pred(c)$  are set to 2. Next, the algorithm is invoked for  $f$ , a descendant of  $c$ , so that  $num(f)$  and  $pred(f)$  are set to 3, and then it is invoked for  $a$ , a descendant of  $f$ . Because  $num(a)$  is not 0 and  $a$  is not  $f$ 's parent,  $pred(f)$  is set to  $1 = \min(pred(f), num(a)) = \min(3, 1)$ .

This algorithm also outputs the edges in detected blocks, and these edges are shown in Figure 8.16d at the moment they were output after popping them off the stack.

### 8.6.2 Connectivity in Directed Graphs

For directed graphs, connectedness can be defined in two ways depending on whether or not the direction of the edges is taken into account. A directed graph is *weakly connected* if the undirected graph with the same vertices and the same edges is connected. A directed graph is *strongly connected* if for each pair of vertices there is a path between them in both directions. The entire digraph is not always strongly connected, but it may be

composed of *strongly connected components* (SCC), which are defined as subsets of vertices of the graph such that each of these subsets induces a strongly connected digraph.

To determine SCCs, we also refer to depth-first search. Let vertex  $v$  be the first vertex of an SCC for which depth-first search is applied. Such a vertex is called the *root of the SCC*. Because each vertex  $u$  in this SCC is reachable from  $v$ ,  $num(v) < num(u)$ , and only after all such vertices  $u$  have been visited, the depth-first search backtracks to  $v$ . In this case, which is recognized by the fact that  $pred(v) = num(v)$ , the SCC accessible from the root can be output.

The problem now is how to find all such roots of the digraph, which is analogous to finding articulation points in an undirected graph. To that end, the parameter  $pred(v)$  is also used, where  $pred(v)$  is the lower number chosen out of  $num(v)$  and  $pred(u)$ , where  $u$  is a vertex reachable from  $v$  and belonging to the same SCC as  $v$ . How can we determine whether two vertices belong to the same SCC before the SCC has been determined? The apparent circularity is solved by using a stack that stores all vertices belonging to the SCCs under construction. The topmost vertices on the stack belong to the currently analyzed SCC. Although construction is not finished, we at least know which vertices are already included in the SCC. The algorithm attributed to Tarjan is as follows:

```

strongDFS(v)
    pred(v) = num(v) = i++;
    push(v);
    for all vertices u adjacent to v
        if num(u) is 0
            strongDFS(u);
            pred(v) = min(pred(v), pred(u));           // take a predecessor higher up in
        else if num(u) < num(v) and u is on stack      // tree; update if back edge found
            pred(v) = min(pred(v), num(u));           // to vertex u is in the same SCC;
    if pred(v) == num(v)                               // if the root of a SCC is found,
        w = pop();                                    // output this SCC, i.e.,
        while w ≠ v                                  // pop all vertices off the stack
            output w;                                 // until v is popped off;
        w = pop();
        output w;                                     // w == v;

stronglyConnectedComponentSearch()
    for all vertices v
        num(v) = 0;
    i = 1;
    while there is a vertex v such that num(v) == 0
        strongDFS(v);

```

Figure 8.17 contains a sample execution of Tarjan's algorithm. The digraph in Figure 8.17a is processed by a series of calls to `strongDFS()`, which assigns to vertices  $a$  through  $k$  the numbers shown in parentheses in Figure 8.17b. During this process, five SCCs are detected:  $\{a, c, f\}$ ,  $\{b, d, e, g, h\}$ ,  $\{i\}$ ,  $\{j\}$ , and  $\{k\}$ . Figure 8.17c contains the depth-first search trees created by this process. Note that two trees are created so that the number of trees does not have to correspond to the number of SCCs, as the number of trees did not correspond to the number of blocks in the case for undirected graphs. Figure



8.17d indicates, in italics, numbers assigned to  $num(v)$  and all changes of parameter  $pred(v)$  for all vertices  $v$  in the graph. It also shows the SCC's output during the processing of the graph.

## 8.7 TOPOLOGICAL SORT

In many situations, there is a set of tasks to be performed. For some pairs of tasks, it matters which task is performed first, whereas for other pairs, the order of execution is unimportant. For example, students need to take into consideration which courses are prerequisites or corequisites for other courses when making a schedule for the upcoming semester so that Computer Programming II cannot be taken before Computer Programming I, but the former can be taken along with, say, Ethics or Introduction to Sociology.

The dependencies between tasks can be shown in the form of a digraph. A *topological sort* linearizes a digraph; that is, it labels all its vertices with numbers  $1, \dots, |V|$  so that  $i < j$  only if there is a path from vertex  $v_i$  to vertex  $v_j$ . The digraph must not include a cycle; otherwise, a topological sort is impossible.

The algorithm for a topological sort is rather simple. We have to find a vertex  $v$  with no outgoing edges, called a *sink* or a *minimal vertex*, and then disregard all edges leading from any vertex to  $v$ . The summary of the topological sort algorithm is as follows:

```

topologicalSort(digraph)
  for i = 1 to |V|
    find a minimal vertex v;
    num(v) = i;
    remove from digraph vertex v and all edges incident with v;

```

Figure 8.18 contains an example of an application of this algorithm. The graph in Figure 8.18a undergoes a sequence of deletions (Figures 8.18b–f) and results in the sequence *g, e, b, f, d, c, a*.

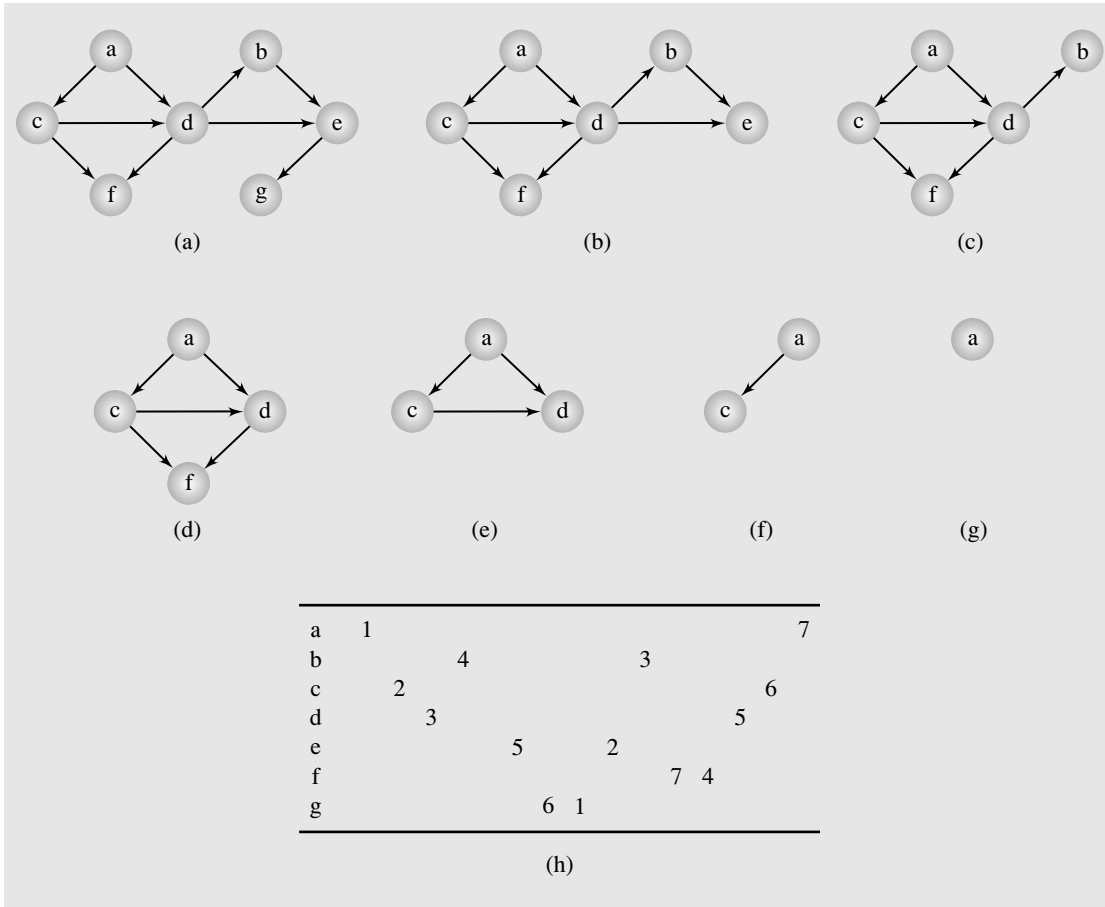
Actually, it is not necessary to remove the vertices and edges from the digraph while it is processed if it can be ascertained that all successors of the vertex being processed have already been processed, so they can be considered as deleted. And once again, depth-first search comes to the rescue. By the nature of this method, if the search backtracks to a vertex  $v$ , then all successors of  $v$  can be assumed to have already been searched (that is, output and deleted from the digraph). Here is how depth-first search can be adapted to topological sort:

```

TS(v)
  num(v) = i++;
  for all vertices u adjacent to v
    if num(u) == 0
      TS(u);
    else if TSNum(u) == 0
      error; // a cycle detected;
  TSNum(v) = j++; // after processing all successors of v,
                  // assign to v a number larger than
                  // assigned to any of its successors;

```

**FIGURE 8.18** Executing a topological sort.



```

topologicalSorting(digraph)
  for all vertices v
    num(v) = TSNum(v) = 0;
  i = j = 1;
  while there is a vertex v such that num(v) == 0
    TS(v);
  output vertices according to their TSNum's;

```

The table in Figure 8.18h indicates the order in which this algorithm assigns  $num(v)$ , the first number in each row, and  $TSNum(v)$ , the second number, for each vertex  $v$  of the graph in Figure 8.18a.

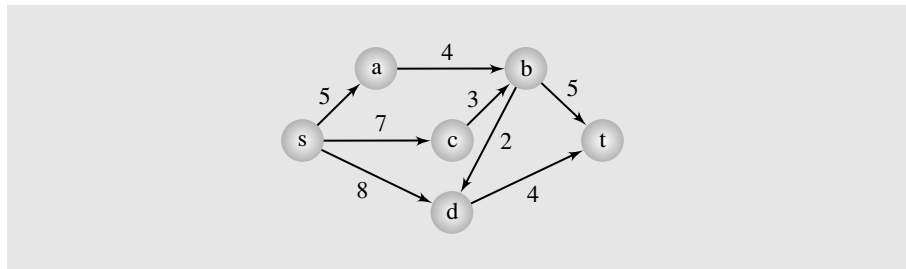


## 8.8 NETWORKS

### 8.8.1 Maximum Flows

An important type of graph is a network. A network can be exemplified by a network of pipelines used to deliver water from one source to one destination. However, water is not simply pumped through one pipe, but through many pipes with many pumping stations in between. The pipes are of different diameter and the stations are of different power so that the amount of water that can be pumped may differ from one pipeline to another. For example, the network in Figure 8.19 has eight pipes and six pumping stations. The numbers shown in this figure are the maximum capacities of each pipeline. For example, the pipe going northeast from the source  $s$ , the pipe  $sa$ , has a capacity of 5 units (say, 5,000 gallons per hour). The problem is to maximize the capacity of the entire network so that it can transfer the maximum amount of water. It may not be obvious how to accomplish this goal. Notice that the pipe  $sa$  coming from the source goes to a station that has only one outgoing pipe,  $ab$ , of capacity 4. This means that we cannot put 5 units through pipe  $sa$ , because pipe  $ab$  cannot transfer it. Also, the amount of water coming to station  $b$  has to be controlled as well because if both incoming pipes,  $ab$  and  $cb$ , are used to full capacity, then the outgoing pipe,  $bt$ , cannot process it either. It is far from obvious, especially for large networks, what the amounts of water put through each pipe should be to utilize the network maximally. Computational analysis of this particular network problem was initiated by Lester R. Ford and D. Ray Fulkerson. Since their work, scores of algorithms have been published to solve this problem.

**FIGURE 8.19** A pipeline with eight pipes and six pumping stations.



Before the problem is stated more formally, I would like to give some definitions. A *network* is a digraph with one vertex  $s$ , called the *source*, with no incoming edges, and one vertex  $t$ , called the *sink*, with no outgoing edges. (These definitions are chosen for their intuitiveness; however, in a more general case, both source and sink can be any two vertices.) With each edge  $e$  we associate a number  $cap(e)$  called the *capacity* of the edge. A *flow* is a real function  $f: E \rightarrow \mathbb{R}$  that assigns a number to each edge of the network and meets these two conditions:

1. The flow through an edge  $e$  cannot be greater than its capacity, or  $0 \leq f(e) \leq cap(e)$  (capacity constraint).

2. The total flow coming to a vertex  $v$  is the same as the total flow coming from it, or  $\sum_u f(\text{edge}(uv)) = \sum_w f(\text{edge}(vw))$ , where  $v$  is neither the source nor the sink (flow conservation).

The problem now is to maximize the flow  $f$  so that the sum  $\sum_u f(\text{edge}(ut))$  has a maximum value for any possible function  $f$ . This is called a *maximum-flow* (or *max-flow*) *problem*.

An important concept used in the Ford-Fulkerson algorithm is the concept of cut. A *cut separating  $s$  and  $t$*  is a set of edges between vertices of set  $X$  and vertices of set  $\bar{X}$ ; any vertex of the graph belongs to one of these sets, and source  $s$  is in  $X$  and sink  $t$  is in  $\bar{X}$ . For example, in Figure 8.19, if  $X = \{s, a\}$ , then  $\bar{X} = \{b, c, d, t\}$ , and the cut is the set of edges  $\{(a, b), (s, c), (s, d)\}$ . This means that if all edges belonging to this set are cut, then there is no way to get from  $s$  to  $t$ . Let us define the capacity of the cut as the sum of capacities of all its edges leading from a vertex in  $X$  to a vertex in  $\bar{X}$ ; thus,  $\text{cap}\{(a, b), (s, c), (s, d)\} = \text{cap}(a, b) + \text{cap}(s, c) + \text{cap}(s, d) = 19$ . Now, it should be clear that the flow through the network cannot be greater than the capacity of any cut. This observation leads to the *max-flow min-cut theorem* (Ford and Fulkerson 1956):

**Theorem.** In any network, the maximal flow from  $s$  to  $t$  is equal to the minimal capacity of any cut.

This theorem states what is expressed in the simile of a chain being as strong as its weakest link. Although there may be cuts with great capacity, the cut with the smallest capacity determines the flow of the network. For example, although the capacity  $\text{cap}\{(a, b), (s, c), (s, d)\} = 19$ , two edges coming to  $t$  cannot transfer more than 9 units. Now we have to find a cut that has the smallest capacity among all possible cuts and transfer through each edge of this cut as many units as the capacity allows. To that end, a new concept is used.

A *flow-augmenting path* from  $s$  to  $t$  is a sequence of edges from  $s$  to  $t$  such that, for each edge in this path, the flow  $f(e) < \text{cap}(e)$  on forward edges and  $f(e) > 0$  on backward edges. It means that such a path is not optimally used yet, and it can transfer more units than it is currently transferring. If the flow for at least one edge of the path reaches its capacity, then obviously the flow cannot be augmented. Note that the path does not have to consist only of forward edges, so that examples of paths in Figure 8.19 are  $s, a, b, t$ , and  $s, d, b, t$ . Backward edges are what they are, backward; they push back some units of flow, decreasing the flow of the network. If they can be eliminated, then the overall flow in the network can be increased. Hence, the process of augmenting flows of paths is not finished until the flow for such edges is zero. Our task now is to find an augmenting path if it exists. There may be a very large number of paths from  $s$  to  $t$ , so finding an augmenting path is a nontrivial problem, and Ford and Fulkerson (1957) devised the first algorithm to accomplish it in a systematic manner.

The *labeling* phase of the algorithm consists of assigning to each vertex  $v$  a label, which is the pair

$$\text{label}(v) = (\text{parent}(v), \text{slack}(v))$$

where  $\text{parent}(v)$  is the vertex from which  $v$  is being accessed and  $\text{slack}(v)$  is the amount of flow that can be transferred from  $s$  to  $v$ . The forward and backward edges are treated differently. If a vertex  $u$  is accessed from  $v$  through a forward edge, then

$$\text{label}(u) = (v^+, \min(\text{slack}(v), \text{slack}(\text{edge}(vu))))$$

where

$$\text{slack}(\text{edge}(vu)) = \text{cap}(\text{edge}(vu)) - f(\text{edge}(vu))$$

which is the difference between the capacity of  $\text{edge}(vu)$  and the amount of flow currently carried by this edge. If the edge from  $v$  to  $u$  is backward (i.e., forward from  $u$  to  $v$ ), then

$$\text{label}(u) = (v^-, \min(\text{slack}(v), f(\text{edge}(uv))))$$

and

$$\text{slack}(v) = \min(\text{slack}(\text{parent}(v)), \text{slack}(\text{edge}(\text{parent}(v)v)))$$

After a vertex is labeled, it is stored for later processing. In this process, only this  $\text{edge}(vu)$  is labeled, which allows for some more flow to be added. For forward edges, this is possible when  $\text{slack}(\text{edge}(vu)) > 0$ , and for backward edges when  $f(\text{edge}(uv)) > 0$ . However, finding one such path may not finish the entire process. The process is finished if we are stuck in the middle of the network unable to label any more edges. If we reach the sink  $t$ , the flows of the edges on the augmenting path that was just found are updated by increasing flows of forward edges and decreasing flows of backward edges, and the process restarts in the quest for another augmenting path. Here is a summary of the algorithm.

```

augmentPath(network with source s and sink t)
  for each edge e in the path from s to t
    if forward(e)
      f(e) += slack(t);
    else f(e) -= slack(t);

FordFulkersonAlgorithm(network with source s and sink t)
  set flow of all edges and vertices to 0;
  label(s) = (null, ∞);
  labeled = {s};
  while labeled is not empty // while not stuck;
    detach a vertex v from labeled;
    for all unlabeled vertices u adjacent to v
      if forward(edge(vu)) and slack(edge(vu)) > 0
        label(u) = (v+, min(slack(v), slack(edge(vu))))
      else if backward(edge(vu)) and f(edge(uv)) > 0
        label(u) = (v-, min(slack(v), f(edge(uv))));
      if u got labeled
        if u == t
          augmentPath(network);
          labeled = {s}; // look for another path;
        else include u in labeled;

```

Notice that this algorithm is noncommittal with respect to the way the network should be scanned. In exactly what order should vertices be included in `labeled` and detached from it? This question is left open, and we choose push and pop as implementations of these two operations, thereby processing the network in a depth-first fashion.

Figure 8.20 illustrates an example. Each edge has two numbers associated with it, the capacity and the current flow, and initially the flow is set to zero for each edge (8.20a). We begin by putting the vertex  $s$  in `labeled`. In the first iteration of the `while` loop,  $s$  is detached from `labeled`, and in the `for` loop, label  $(s,2)$  is assigned to the first adjacent vertex,  $a$ ; label  $(s,4)$  to vertex  $c$ ; and label  $(s,1)$  to vertex  $e$  (Figure 8.20b), and all three vertices are pushed onto `labeled`. The `for` loop is exited, and because `labeled` is not empty, the `while` loop begins its second iteration. In this iteration, a vertex is popped off from `labeled`, which is  $e$ , and both unlabeled vertices incident to  $e$ , vertices  $d$  and  $f$ , are labeled and pushed onto `labeled`. Now, the third iteration of the `while` loop begins by popping  $f$  from `labeled` and labeling its only unlabeled neighbor, vertex  $t$ . Because  $t$  is the sink, the flows of all edges on the augmenting path  $s, e, f, t$  are updated in the inner `for` loop (Figure 8.20c), `labeled` is reinitialized to  $\{s\}$ , and the next round begins to find another augmenting path.

The next round starts with the fourth iteration of the `while` loop. In its eighth iteration, the sink is reached (Figure 8.20d) and flows of edges on the new augmenting

**FIGURE 8.20** An execution of `FordFulkersonAlgorithm()` using depth-first search.

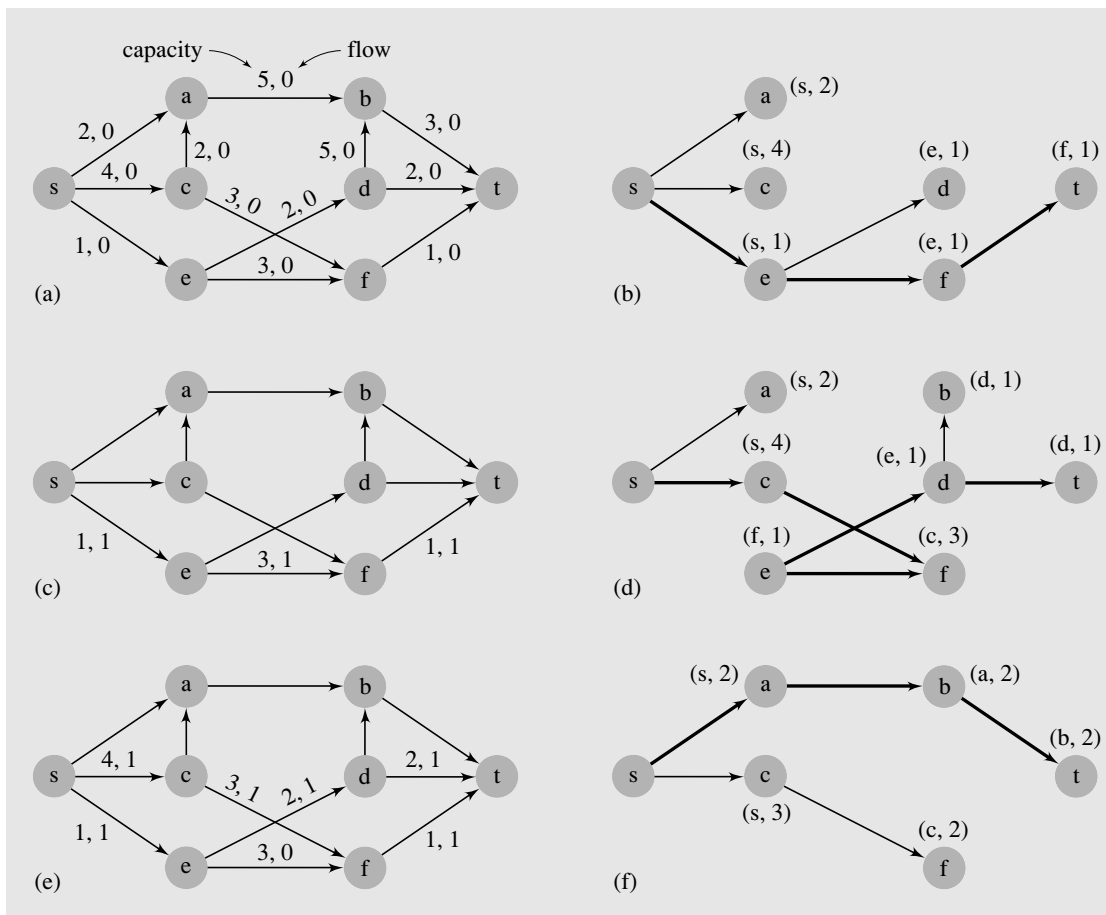
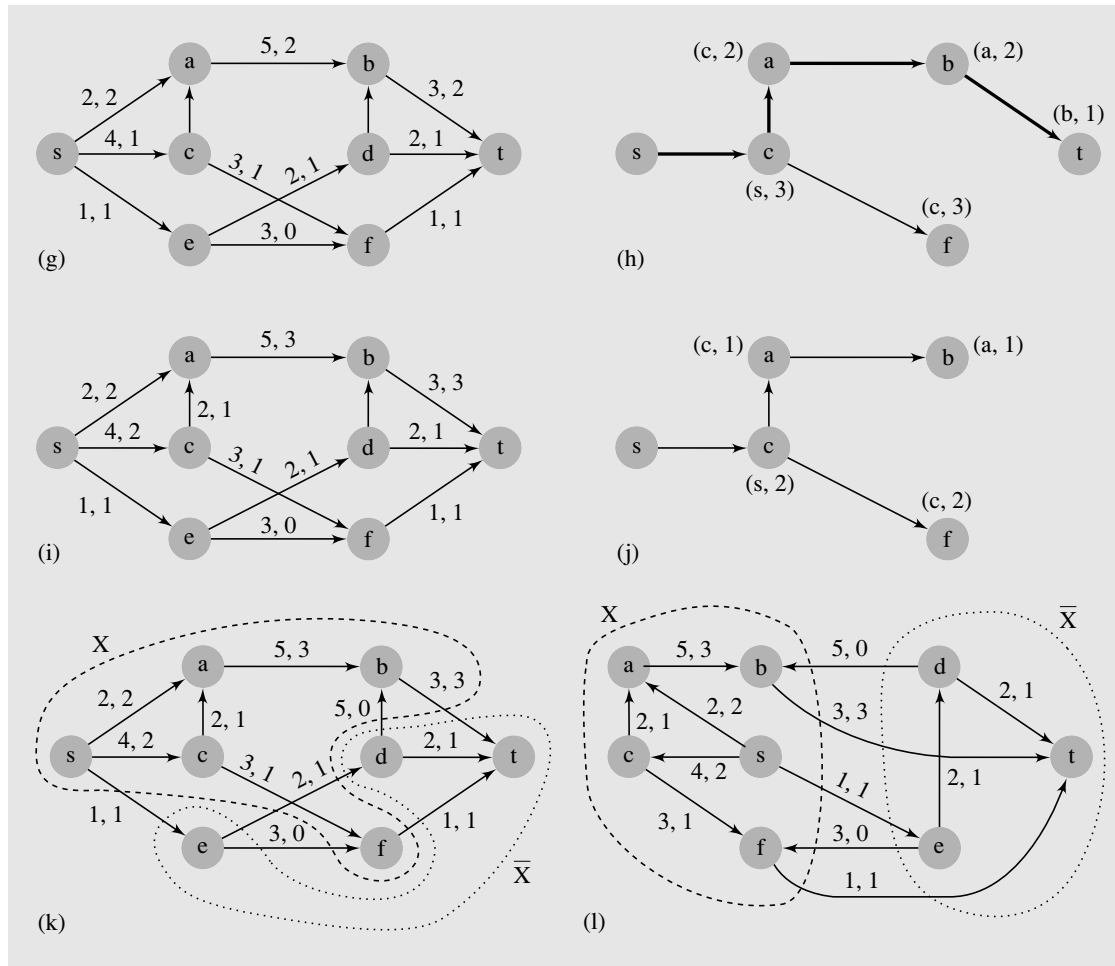


FIGURE 8.20 (continued)

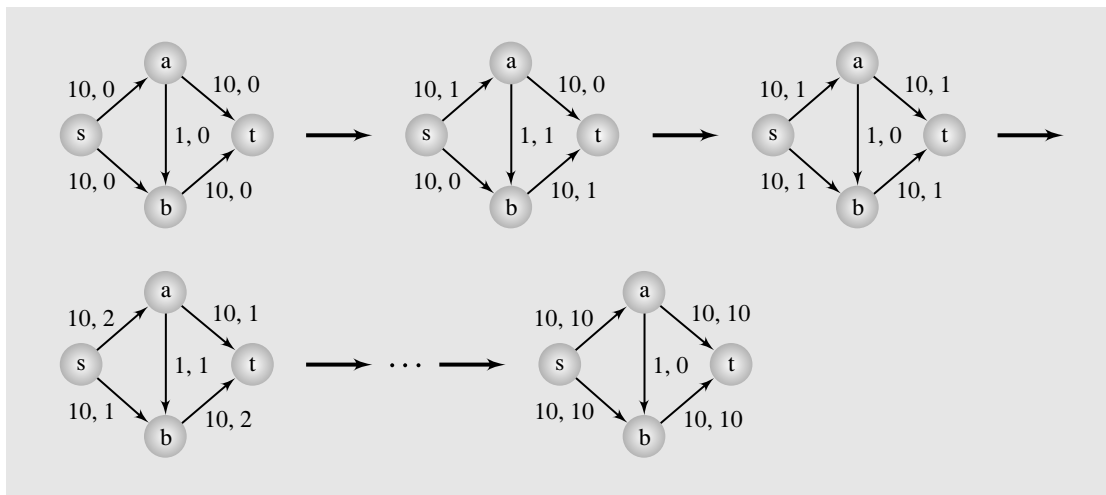


path are updated (Figure 8.20e). Note that this time one edge,  $edge(fe)$ , is a backward edge. Therefore, its flow is decremented, not incremented as is the case for forward edges. The one unit of flow that was transferred from vertex  $e$  through  $edge(fe)$  is redirected to  $edge(ed)$ . Afterward, two more augmenting paths are found and corresponding edges are updated. In the last round, we are unable to reach the sink (Figure 8.20j), which means that all augmenting edges have been found and the maximum flow has been determined.

If after finishing execution of the algorithm all vertices labeled in the last round, including the source, are put in the set  $X$  and the unlabeled vertices in the set  $\bar{X}$ , then we have a min-cut (Figure 8.20k). For clarity, both sets are also shown in Figure 8.20l. Note that all the edges from  $X$  to  $\bar{X}$  are used in full capacity, and all the edges from  $\bar{X}$  to  $X$  do not transfer any flow at all.

The complexity of this implementation of the algorithm is not necessarily a function of the number of vertices and edges in the network. Consider the network in Figure 8.21. Using a depth-first implementation, we could choose the augmenting path  $s, a, b, t$  with flows of all three edges set to 1. The next augmenting path could be  $s, b, a, t$  with flows of two forward edges set to 1 and the flow of one backward  $edge(ba)$  reset to 0. Next time, the augmenting path could be the same as the first, with flows of two edges set to 2 and with the vertical edge set to 1. It is clear that an augmenting path could be chosen  $2 \cdot 10$  times, although there are only four vertices in the network.

**FIGURE 8.21** An example of an inefficiency of `FordFulkersonAlgorithm()`.

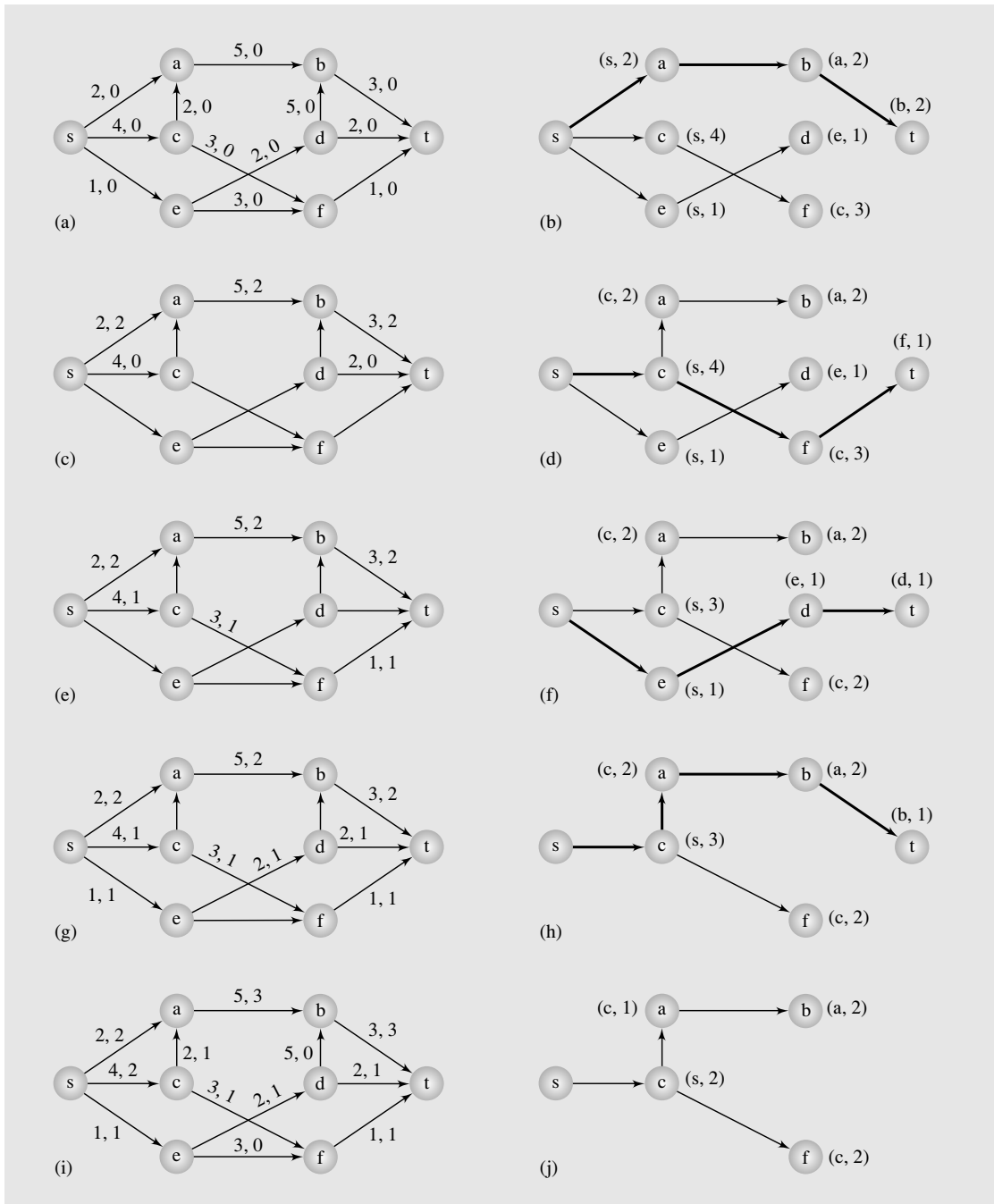


The problem with `FordFulkersonAlgorithm()` is that it uses the depth-first approach when searching for an augmenting path. But as already mentioned, this choice does not stem from the nature of this algorithm. The depth-first approach attempts to reach the sink as soon as possible. However, trying to find the shortest augmenting path gives better results. This leads to a breadth-first approach (Edmonds and Karp 1972). The breadth-first processing uses the same procedure as `FordFulkersonAlgorithm()` except that this time `labeled` is a queue. Figure 8.22 illustrates an example.

To determine one single augmenting path, the algorithm requires at most  $2|E|$ , or  $O(|E|)$  steps, to check both sides of each edge. The shortest augmenting path in the network can have only one edge, and the longest path can have at most  $|V| - 1$  edges. Therefore, there can be augmenting paths of lengths  $1, 2, \dots, |V| - 1$ . The number of augmenting paths of a certain length is at most  $|E|$ . Therefore, to find all augmenting paths of all possible lengths, the algorithm needs to perform  $O(|V||E|)$  steps. And because finding one such path is of order  $O(|E|)$ , the algorithm is of order  $O(|V||E|^2)$ .

Although the pure breadth-first search approach is better than the pure depth-first search implementation, it still is far from ideal. We will not fall into a loop of tiny increments of augmenting steps anymore, but there still seems to be a great deal

**FIGURE 8.22** An execution of `FordFulkersonAlgorithm()` using breadth-first search.



of wasted effort. In breadth-first search, a large number of vertices are labeled to find the shortest path (shortest in a given iteration). Then all these labels are discarded to re-create them when looking for another augmenting path ( $edge(sc)$ ,  $edge(se)$ , and  $edge(cf)$  in Figure 8.22b–d). Therefore, it is desirable to reduce this redundancy. Also, there is some merit to using the depth-first approach in that it attempts to aim at the goal, the sink, without expanding a number of paths at the same time and finally choosing only one and discarding the rest. Hence, the Solomonic solution appears to use both approaches, depth-first and breadth-first. Breadth-first search prepares the ground to prevent loops of small increments from happening (as in Figure 8.21) and to guarantee that depth-first search takes the shortest route. Only afterward, the depth-first search is launched to find the sink by aiming right at it. An algorithm based upon this principle was devised first by Efim A. Dinic (pronounced: dee-neetz).

In Dinic's algorithm, up to  $|V| - 1$  passes (or phases) through the network are performed, and in each pass, all augmenting paths of the same length from the source to the sink are determined. Then, only some or all of these paths are augmented.

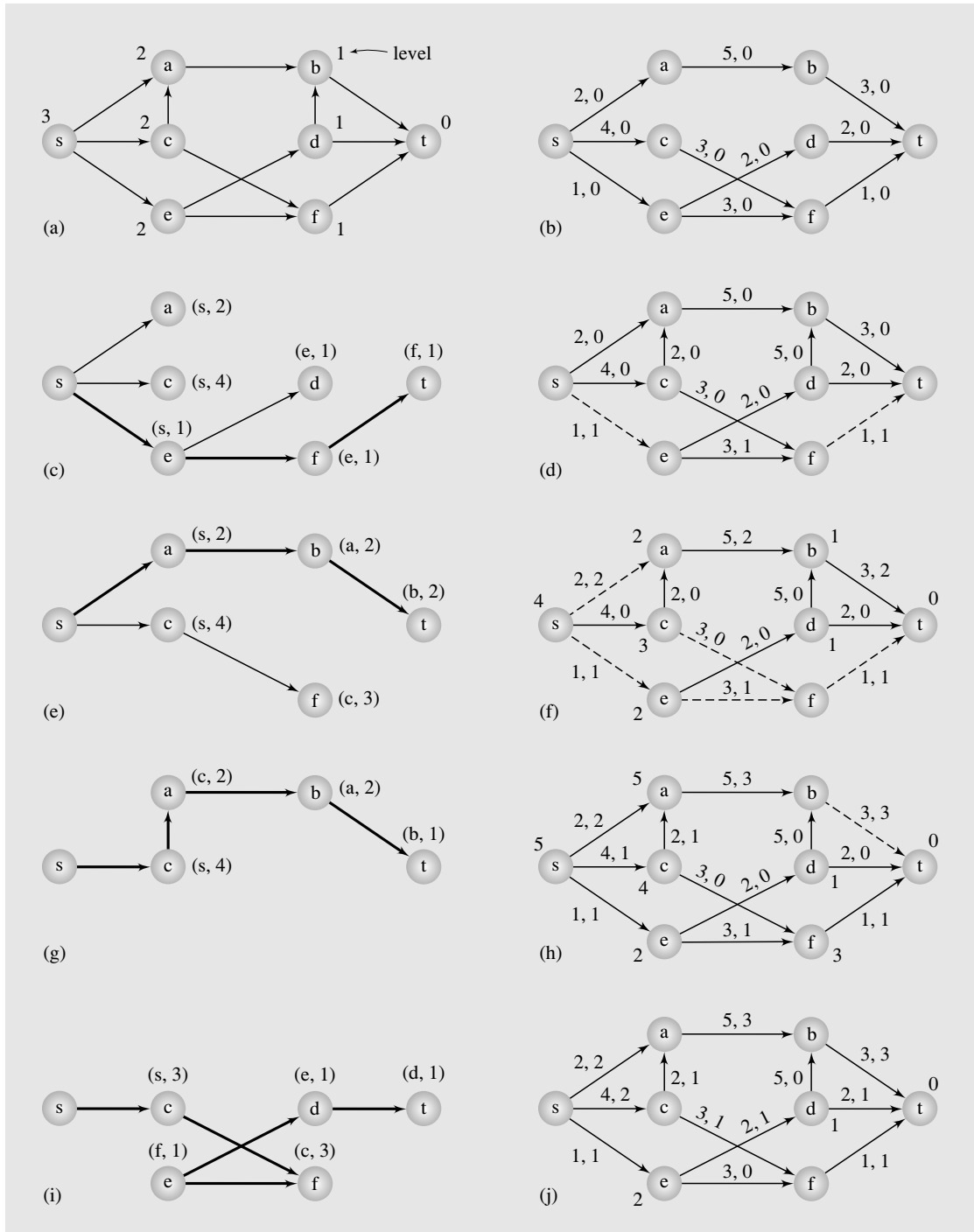
All augmenting paths form a *layered network* (also called a *level network*). Extracting layered networks from the underlying network starts from the lowest values. First, a layered network of a path of length one is found, if such a network exists. After the network is processed, a layered network of paths of length two is determined, if it exists, and so on. For example, the layered network with the shortest paths corresponding with the network in Figure 8.23a is shown in Figure 8.23b. In this network, all augmenting paths are of length three. A layered network with a single path of length one and layered networks with paths of length two do not exist. The layered network is created using breadth-first processing, and only forward edges that can carry more flow and backward edges that already carry some flow are included. Otherwise, even if an edge may lay on a short path from the source to the sink, it is not included. Note that the layered network is determined by breadth-first search that begins in the sink and ends in the source.

Now, because all the paths in a layered network are of the same length, it is possible to avoid redundant tests of edges that are part of augmenting paths. If in a current layered network there is no way to go from a vertex  $v$  to any of its neighbors, then in later tests in the same layered network there will be the same situation; hence, checking again all neighbors of  $v$  is not needed. Therefore, if such a dead-end vertex  $v$  is detected, all edges incident with  $v$  are marked as blocked so that there is no possibility to get to  $v$  from any direction. Also, all saturated edges are considered blocked. All blocked edges are shown in dashed lines in Figure 8.23.

After a layered network is determined, the depth-first process finds as many augmenting paths as possible. Because all paths are of the same length, depth-first search does not go to the sink through some longer sequence of edges. After one such path is found, it is augmented and another augmenting path of the same length is looked for. For each such path, at least one edge becomes saturated so that eventually no augmenting path can be found. For example, in the layered network in Figure 8.23b that includes only augmenting paths three edges long, path  $s, e, t$  is found (Figure 8.23c), and all its edges are augmented (Figure 8.23d). Then only one more three-edge path is found, the path  $s, a, t$  (8.23e), because, for example, previous augmentation saturated  $edge(ft)$  so that the partial path  $s, c, f$  ends with a dead end. In addition, because



**FIGURE 8.23** An execution of DinicAlgorithm().



no other vertex can be reached from  $f$ , all edges incident with  $f$  are blocked (Figure 8.23f) so that an attempt to find the third three-edge augmenting path only tests vertex  $c$ , but not vertex  $f$ , because  $edge(cf)$  is blocked.

If no more augmenting paths can be found, a higher level layered network is found, and augmenting paths for this network are searched for. The process stops when no layered network can be formed. For example, out of the network in Figure 8.23f, the layered network in Figure 8.23g is formed, which has only one four-edge path. To be sure, this is the only augmenting path for this network. After augmenting this path, the situation in the network is as in Figure 8.23h, and the last layered network is formed, which also has only one path, this time a path of five edges. The path is augmented (Figure 8.23j) and then no other layered network can be found. This algorithm can be summarized in the following pseudocode:

```

layerNetwork(network with source s and sink t)
  for all vertices u
    level(u) = -1;
  level(t) = 0;
  enqueue(t);
  while queue is not empty
    v = dequeue();
    for all vertices u adjacent to v such that level(u) == -1
      if forward(edge(uv)) and slack(edge(uv)) > 0 or
         backward(edge(uv)) and f(edge(vu)) > 0
        level(u) = level(v)+1;
        enqueue(u);
    if u == s
      return success;
  return failure;

processAugmentingPaths(network with source s and sink t)
  unblock all edges;
  labeled = {s};
  while labeled is not empty // while not stuck;
    pop v from labeled;
    for all unlabeled vertices u adjacent to v such that
      edge(vu) is not blocked and level(v) == level(u) +1
      if forward(edge(vu)) and slack(edge(vu)) > 0
        label(u) = (v+, min(slack(v), slack(edge(vu))))
      else if backward(edge(vu)) and f(edge(uv)) > 0
        label(u) = (v-, min(slack(v), f(edge(uv))));
      if u got labeled
        if u == t
          augmentPath(network);
          block saturated edges;
          labeled = {s}; // look for another path;
        else push u onto labeled;
    if no neighbor of v has been labeled
      block all edges incident with v;

```

```

DinicAlgorithm(network with source s sink t)
  set flows of all edges and vertices to 0;
  label(s) = (null, ∞);
  while layerNetwork(network) is successful
    processAugmentingPaths(network);

```

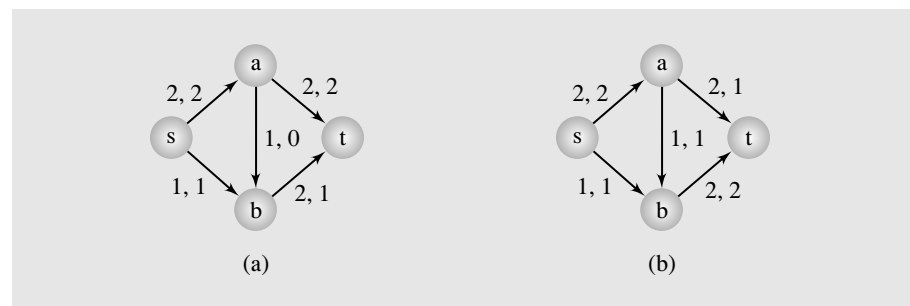
What is the complexity of this algorithm? There are maximum  $|V| - 1$  layerings (phases) and up to  $O(|E|)$  steps to layer the network. Hence, finding all the layered networks requires  $O(|V||E|)$  steps. Moreover, there are  $O(|E|)$  paths per phase (per one layered network) and, due to blocking,  $O(|V|)$  steps to find one path, and because there are  $O(|V|)$  layered networks, in the worst case,  $O(|V|^2|E|)$  steps are required to find the augmenting paths. This estimation determines the efficiency of the algorithm, which is better than  $O(|V||E|^2)$  for breadth-first `FordFulkersonAlgorithm()`. The improvement is in the number of steps to find one augmenting path, which is now  $O(|V|)$ , not  $O(|E|)$ , as before. The price for this improvement is the need to prepare the network by creating layered networks, which, as established, require additional  $O(|V||E|)$  steps.

The difference in pseudocode for `FordFulkersonAlgorithm()` and `processAugmentingPaths()` is not large. The most important difference is in the amplified condition for expanding a path from a certain vertex  $v$ : Only the edges to adjacent vertices  $u$  that do not extend augmenting paths beyond the length of paths in the layered network are considered.

### 8.8.2 Maximum Flows of Minimum Cost

In the previous discussion, edges had two parameters, capacity and flow: how much flow they can carry and how much flow they are actually carrying. But although many different maximum flows through the network are possible, we choose the one dictated by the algorithm currently in use. For example, Figure 8.24 illustrates two possible maximum flows for the same network. Note that in the first case, the *edge*( $ab$ ) is not used at all; only in the second case are all the edges transferring some flow. The breadth-first algorithm leads to the first maximum flow and finishes our quest for maximum flow after identifying it. However, in many situations, this is not a good decision. If there are many possible maximum flows, it does not mean that any one of them is equally good.

**FIGURE 8.24** Two possible maximum flows for the same network.



Consider the following example. If edges are roads between some locations, then it is not enough to know that a road has one or two lanes to choose a proper route. If the  $distance(a,t)$  is very long and  $distance(a,b)$  and  $distance(b,t)$  are relatively short, then it is better to consider the second maximum flow (Figure 8.24b) as a viable option rather than the first (Figure 8.24a). However, this may not be enough. The shorter way can have no pavement: It can be muddy, hilly, close to the avalanche areas, or sometimes blocked by boulders, among other disadvantages. Hence, using the distance as the sole criterion for choosing a road is insufficient. Taking the roundabout way may bring us to the destination faster and cheaper (to mention only time and gasoline burned).

We clearly need a third parameter for an edge: the *cost* of transferring one unit of flow through this edge. The problem now is how to find a maximum flow at minimum cost. More formally, if for each edge  $e$ , the  $cost(e)$  of sending one unit of flow is determined so that it costs  $n \cdot cost(e)$  to transmit  $n$  units of flow over edge  $e$ , then we need to find a maximum flow  $f$  of minimum cost, or a flow such that

$$cost(f) = \min\{\sum_{e \in E} f(e) \cdot cost(e) : f \text{ is a maximum flow}\}$$

Finding all possible maximum flows and comparing their costs is not a feasible solution because the amount of work to find all such flows can be prohibitive. Algorithms are needed that find not only a maximum flow, but also the maximum flow at minimum cost.

One strategy is based on the following theorem, proven first by W. S. Jewell, R. G. Busacker, and P. J. Gowen, and implicitly used by M. Iri (Ford and Fulkerson, 1962):

**Theorem.** If  $f$  is a minimal-cost flow with the flow value  $v$  and  $p$  is the minimum cost augmenting path sending a flow of value 1 from the source to the sink, then the flow  $f + p$  is minimal and its flow value is  $v + 1$ .

The theorem should be intuitively clear. If we determined the cheapest way to send  $v$  units of flow through the network and afterward found a path that is the cheapest way for sending 1 unit of flow from the source to the sink, then we found the cheapest way to send  $v + 1$  units using the route, which is a combination of the route already determined and the path just found. If this augmenting path allows for sending 1 unit for minimum cost, then it also allows for sending 2 units at minimum cost, and also 3 units, up to  $n$  units, where  $n$  is the maximum amount of units that can be sent through this path; that is,

$$n = \min\{capacity(e) - f(e) : e \text{ is an edge in minimum cost augmenting path}\}$$

This also suggests how we can proceed systematically to find the cheapest maximum route. We start with all flows set to zero. In the first pass, we find the cheapest way to send 1 unit and then send as many units through this path as possible. After the second iteration, we find a path to send 1 unit at least cost, and we send through this path as many units as this path can hold, and so on until no further dispatch from the source can be made or the sink cannot accept any more flow.

Note that the problem of finding maximum flow of minimum cost bears some resemblance to the problem of finding the shortest path, because the shortest path can be understood as the path with minimum cost. Hence, a procedure is needed to find the shortest path in the network so that as much flow as possible can be sent through this path. Therefore, a reference to an algorithm that solves the shortest path problem should

not be surprising. We modify Dijkstra's algorithm used for solving the one-to-one shortest path problem (see Exercise 7 at the end of this chapter). Here is the algorithm:

```

modifiedDijkstraAlgorithm(network, s, t)
  for all vertices u
    f(u) = 0;
    cost(u) = ∞;
  set flows of all edges to 0;
  label(s) = (null, ∞, 0);
  labeled = null;
  while (true)
    v = a vertex not in labeled with minimal cost(v);
    if v == t
      if cost(t) == ∞ // no path from s to t can be found;
        return failure;
      else return success;
    add v to labeled;
    for all vertices u not in labeled and adjacent to v
      if forward(edge(vu)) and slack(edge(vu)) > 0 and cost(v) + cost(vu) < cost(u)
        label(u) = (v+, min(slack(v), slack(edge(vu))), cost(v) + cost(vu))
      else if backward(edge(vu)) and f(edge(uv)) > 0 and cost(v) - cost(uv) < cost(u)
        label(u) = (v-, min(slack(v), f(edge(uv))), cost(v) - cost(uv));
maxFlowMinCostAlgorithm(network with source s and sink t)
  while modifiedDijkstraAlgorithm(network, s, t) is successful
    augmentPath(network, s, t);

```

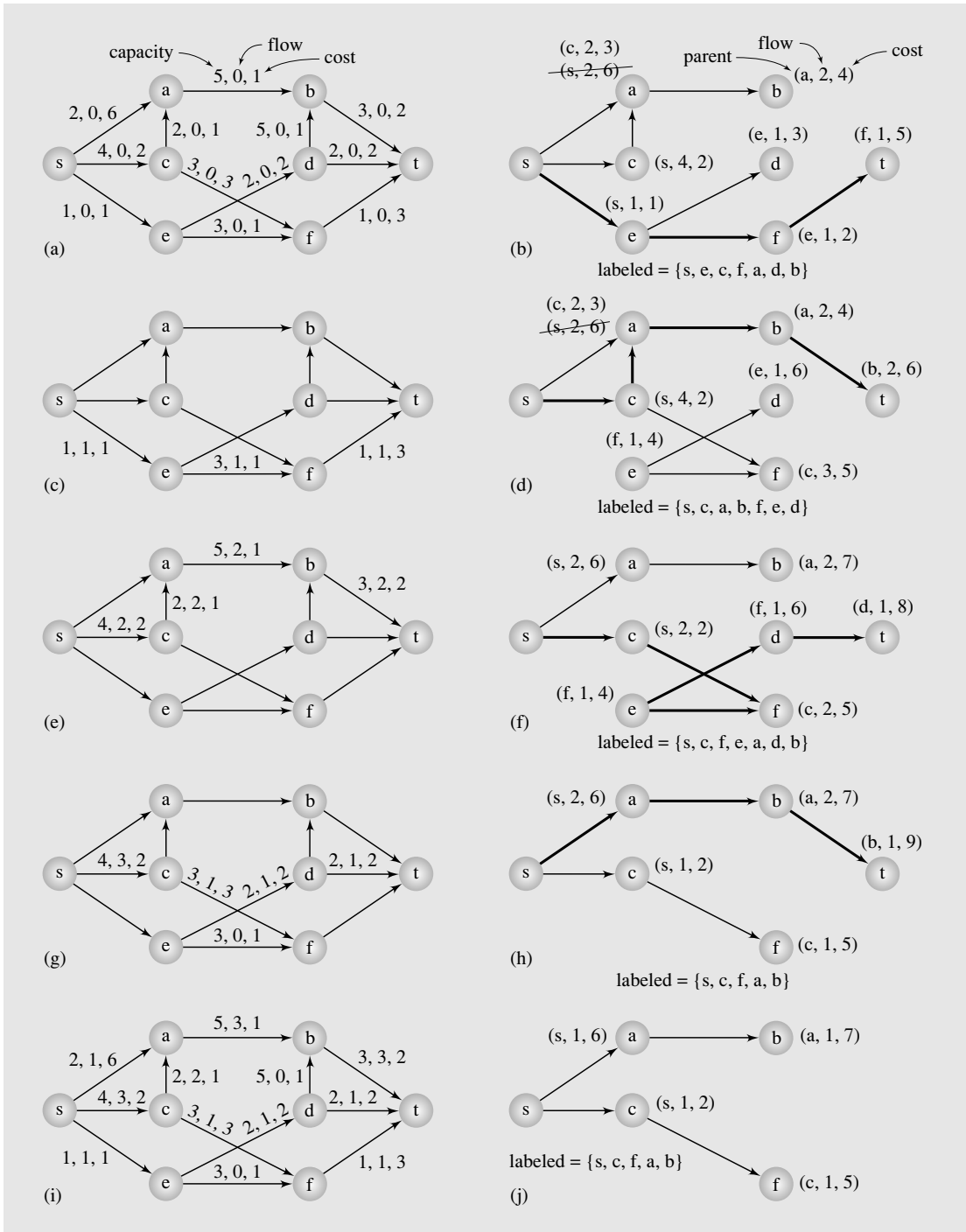
`modifiedDijkstraAlgorithm()` keeps track of three things at a time so that the label for each vertex is the triple

$$\text{label}(u) = (\text{parent}(u), \text{flow}(u), \text{cost}(u))$$

First, for each vertex  $u$ , it records the predecessor  $v$ , the vertex through which  $u$  is accessible from the source  $s$ . Second, it records the maximum amount of flow that can be pushed through the path from  $s$  to  $u$  and eventually to  $t$ . Third, it stores the cost of passing all the edges from the source to  $u$ . For forward  $\text{edge}(vu)$ ,  $\text{cost}(u)$  is the sum of the costs already accumulated in  $v$  plus the cost of pushing one unit of flow through  $\text{edge}(vu)$ . For backward  $\text{edge}(vu)$ , the unit cost of passing through this edge is subtracted from the  $\text{cost}(v)$  and stored in  $\text{cost}(u)$ . Also, flows of edges included in augmented paths are updated; this task is performed by `augmentPath()` (see p. 409).

Figure 8.25 illustrates an example. In the first iteration of the `while` loop, `labeled` becomes  $\{s\}$  and the three vertices adjacent to  $s$  are labeled,  $\text{label}(a) = (s, 2, 6)$ ,  $\text{label}(c) = (s, 4, 2)$ , and  $\text{label}(e) = (s, 1, 1)$ . Then the vertex with the smallest cost is chosen, namely, vertex  $e$ . Now, `labeled` =  $\{s, e\}$  and two vertices acquire new labels,  $\text{label}(d) = (e, 1, 3)$  and  $\text{label}(f) = (e, 1, 2)$ . In the third iteration, vertex  $c$  is chosen, because its cost, 2, is minimal. Vertex  $a$  receives a new label,  $(c, 2, 3)$ , because the cost of accessing it from  $s$  through  $c$  is smaller than accessing it directly from  $s$ . Vertex  $f$ , which is adjacent to  $c$ , does not get a new label, because the cost of sending one unit of flow from  $s$  to  $f$  through  $c$ , 5, exceeds the cost of sending this unit through  $e$ , which is 2. In the fourth iteration,  $f$  is

**FIGURE 8.25** Finding a maximum flow of minimum cost.



chosen, `labeled` becomes  $\{s, e, c, f\}$ , and  $label(t) = (f, 1, 5)$ . After the seventh iteration, the situation in the graph is as pictured in Figure 8.25b. The eighth iteration is exited right after the sink  $t$  is chosen, after which the path  $s, e, f, t$  is augmented (Figure 8.25c). The execution continues, `modifiedDijkstraAlgorithm()` is invoked four more times and in the last invocation no other path can be found from  $s$  to  $t$ . Note that the same paths were found here as in Figure 8.20, although in a different order, which was due to the cost of these paths: 5 is the cost of the first detected path (Figure 8.25b), 6 is the cost of the second path (Figure 8.25d), 8 is the cost of the third (Figure 8.25f), and 9 is the cost of the fourth (Figure 8.25h). But the distribution of flows for particular edges allowing for the maximum flow is slightly different. In Figure 8.20k,  $edge(sa)$  transmits 2 units of flow,  $edge(sc)$  transmits 2 units, and  $edge(ca)$  transmits 1 unit. In Figure 8.25i, the same three edges transmit 1, 3, and 2 units, respectively.

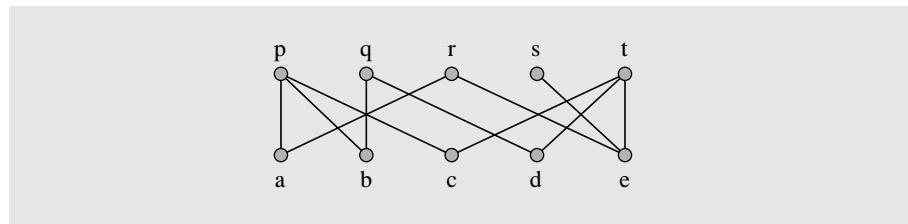
## 8.9 MATCHING

Suppose that there are five job openings  $a, b, c, d,$  and  $e$  and five applicants  $p, q, r, s,$  and  $t$  with qualifications shown in this table:

Applicants:	$p$	$q$	$r$	$s$	$t$
Jobs:	$a b c$	$b d$	$a e$	$e$	$c d e$

The problem is how to find a worker for each job; that is, how to match jobs with workers. There are many problems of this type. The job matching problem can be modeled with a bipartite graph. A *bipartite graph* is one in which the set of vertices  $V$  can be divided into two subsets  $V_1$  and  $V_2$  such that, for each  $edge(vw)$ , if vertex  $v$  is in one of the two sets  $V_1$  or  $V_2$ , then  $w$  is in the other set. In this example, one set of vertices,  $V_1$ , represents applicants, the other set,  $V_2$ , represents jobs, and edges represent jobs for which applicants are qualified (Figure 8.26). The task is to find a match between job and applicants so that one applicant is matched with one job. In a general case, there may not be enough applicants, or there may be no way to assign an applicant for each opening, even if the number of applicants exceeds the number of openings. Hence, the task now is to assign applicants to as many jobs as possible.

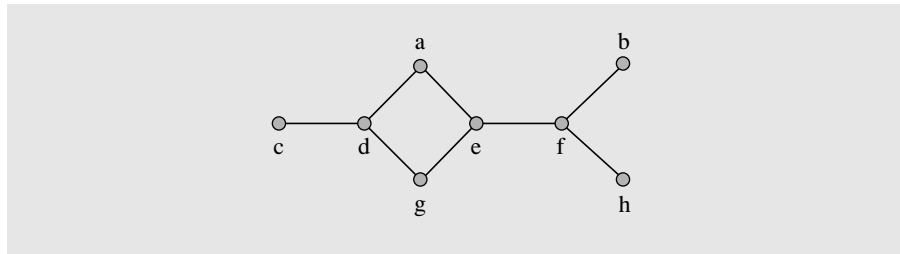
**FIGURE 8.26** Matching five applicants with five jobs.



A *matching*  $M$  in a graph  $G = (V, E)$  is a subset of edges,  $M \subseteq E$ , such that no two edges share the same vertex; that is, no two edges are adjacent. A *maximum matching*

is a matching that contains a maximum number of edges so that the number of unmatched vertices (that is, vertices not incident with edges in  $M$ ) is minimal. For example, in the graph in Figure 8.27, the sets  $M_1 = \{\text{edge}(cd), \text{edge}(ef)\}$  and  $M_2 = \{\text{edge}(cd), \text{edge}(ge), \text{edge}(fh)\}$  are matchings, but  $M_2$  is a maximum matching, whereas  $M_1$  is not. A *perfect matching* is a matching that pairs all the vertices of graph  $G$ . A matching  $M = \{\text{edge}(pc), \text{edge}(qb), \text{edge}(ra), \text{edge}(se), \text{edge}(td)\}$  in Figure 8.26 is a perfect matching, but there is no perfect matching for the graph in Figure 8.27. A *matching problem* consists in finding a maximum matching for a certain graph  $G$ . The problem of finding a perfect matching is also called the *marriage problem*.

**FIGURE 8.27** A graph with matchings  $M_1 = \{\text{edge}(ab), \text{edge}(ef)\}$  and  $M_2 = \{\text{edge}(ab), \text{edge}(de), \text{edge}(fh)\}$ .



An *alternating path* for  $M$  is a sequence of edges  $\text{edge}(v_1v_2), \text{edge}(v_2v_3), \dots, \text{edge}(v_{k-1}v_k)$  that alternately belongs to  $M$  and to  $E - M =$  set of edges that are not in  $M$ . An *augmenting path* for  $M$  is an alternating path where both end vertices are not incident with any edge in matching  $M$ . Thus, an augmenting path has an odd number of edges,  $2k + 1$ ,  $k$  of them belonging to  $M$  and  $k + 1$  not in  $M$ . If edges in  $M$  are replaced by edges not in  $M$ , then there is one more edge in  $M$  than before the interchange. Thus, the cardinality of the matching  $M$  is augmented by one.

A *symmetric difference* between two sets,  $X \oplus Y$ , is the set

$$X \oplus Y = (X - Y) \cup (Y - X) = (X \cup Y) - (X \cap Y)$$

In other words, a symmetric difference  $X \oplus Y$  includes all elements from  $X$  and  $Y$  combined except for the elements that belong at the same time to  $X$  and  $Y$ .

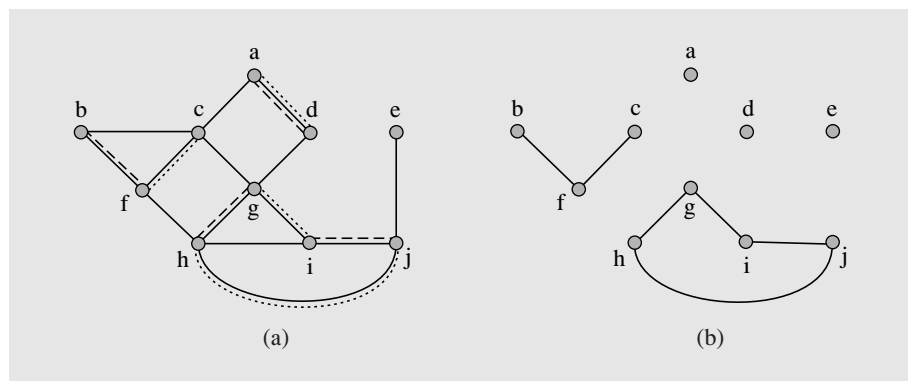
**Lemma 1.** If for two matchings  $M$  and  $N$  in a graph  $G = (V, E)$  we define a set of edges  $M \oplus N \subseteq E$ , then each connected component of the subgraph  $G' = (V, M \oplus N)$  is either (a) a single vertex, (b) a cycle with an even number of edges alternately in  $M$  and  $N$ , or (c) a path whose edges are alternately in  $M$  and  $N$  and such that each end vertex of the path is matched only by one of the two matchings  $M$  and  $N$  (i.e., the whole path should be considered, not just part, to cover the entire connected component).

**Proof.** For each vertex  $v$  of  $G'$ ,  $\text{deg}(v) \leq 2$ , at most one edge of each matching can be incident with  $v$ ; hence, each component of  $G'$  is either a single vertex, a path, or a cycle. If it is a cycle or a path, the edges must alternate between both matchings; otherwise, the definition of matching is violated. Thus, if it is a cycle, the number of edges must be even. If it is a path, then the degree of both end vertices is one so that they can be matched with only one of the matchings, not both.  $\square$



Figure 8.28 contains an example. A symmetric difference between matching  $M = \{edge(ad), edge(bf), edge(gh), edge(ij)\}$  marked with dashed lines and matching  $N = \{edge(ad), edge(cf), edge(gi), edge(hj)\}$  shown in dotted lines is the set  $M \oplus N = \{edge(bf), edge(cf), edge(gh), edge(gi), edge(hj), edge(ij)\}$ , which contains one path and a cycle (Figure 8.28b). The vertices of graph  $G$  that are not incident with any of the edges in  $M \oplus N$  are isolated in the graph  $G' = (V, M \oplus N)$ .

**FIGURE 8.28** (a) Two matchings  $M$  and  $N$  in a graph  $G = (V, E)$  and (b) the graph  $G' = (V, M \oplus N)$ .



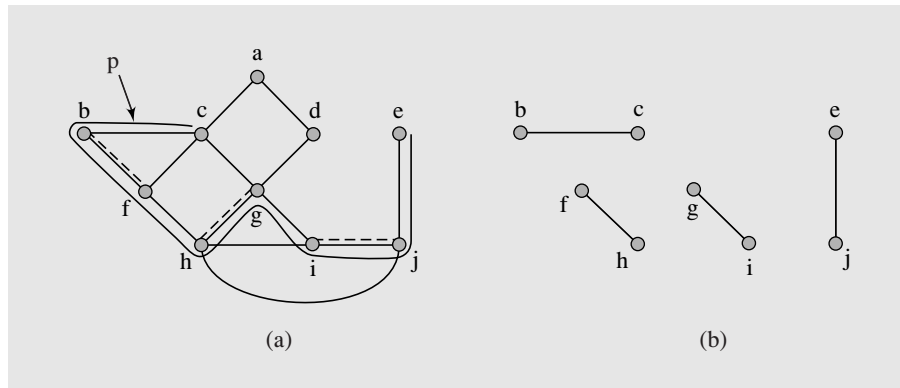
**Lemma 2.** If  $M$  is a matching and  $P$  is an augmenting path for  $M$ , then  $M \oplus P$  is a matching of cardinality  $|M| + 1$ .

**Proof.** By definition of symmetric difference,  $M \oplus P = (M - P) \cup (P - M)$ . Except for the end vertices, all other vertices incident with edges in  $P$  are matched by edges in  $P$ . Hence, no edge in  $M - P$  contains any vertex in  $P$ . Thus, edges in  $M - P$  share no vertices with edges in  $P - M$ . Moreover, because  $P$  is a path with every other edge in  $P - M$ , then  $P - M$  has no edges that share vertices. Hence,  $(M - P) \cup (P - M)$  is a union of two nonoverlapping matchings and thus a matching. If  $|P| = 2k + 1$ , then  $|M - P| = |M| - k$  because all edges in  $M \cup P$  are excluded, and the number of edges in  $P$  but not in  $M$ ,  $|P - M| = k + 1$ . Because  $(M - P)$  and  $(P - M)$  are not overlapping,  $|(M - P) \cup (P - M)| = |M - P| + |P - M| = (|M| - k) + k + 1 = |M| + 1$ . □

Figure 8.29 illustrates this lemma. For matching  $M = \{edge(bf), edge(gh), edge(ij)\}$  shown with dashed lines, and augmenting path  $P$  for  $M$ , the path  $c, b, f, h, g, i, j, e$ , the resulting matching is  $\{edge(bc), edge(ej), edge(fh), edge(gi)\}$ , which includes all the edges from the path  $P$  that were originally excluded from  $M$ . So in effect the lemma finds a larger matching if in an augmenting path the roles of matched and unmatched edges are reversed.

**Theorem** (Berge 1957). A matching  $M$  in a graph  $G$  is maximum if there is no augmenting path connecting two unmatched vertices in  $G$ .

**Proof.**  $\Rightarrow$  By lemma 2, if there were an augmenting path, then a larger matching could be generated; hence,  $M$  would not be a maximum matching.

**FIGURE 8.29** (a) Augmenting path  $P$  and a matching  $M$  and (b) the matching  $M \oplus P$ .

$\Leftarrow$  Suppose  $M$  is not maximum and a matching  $N$  is maximum. Let  $G' = (V, M \oplus N)$ . By lemma 1, connected components of  $G'$  are either cycles of even length or paths (isolated vertices are not included here). If it is a cycle, then half of its edges are in  $N$  and half are in  $M$  because the edges are alternating between  $M$  and  $N$ . If it is an even path, then it also has the same number of edges from  $M$  and  $N$ . However, if it is an odd path, it has more edges from  $N$  than from  $M$ , because  $|N| > |M|$ , and both end vertices are incident with edges from  $N$ . Hence, it is an augmenting path, which leads to contradiction with the assumption that there is no augmenting path.  $\square$

This theorem suggests that a maximum matching can be found by beginning with an initial matching, possibly empty, and then by repeatedly finding new augmenting paths and increasing the cardinality of matching until no such path can be found. This requires an algorithm to determine alternate paths. It is much easier to develop such an algorithm for bipartite graphs than for any other graphs; therefore, we start with a discussion of this simpler case.

To find an augmenting path, breadth-first search is modified to allow for always finding the shortest path. The procedure builds a tree, called a *Hungarian tree*, with an unmatched vertex in the root consisting of alternating paths, and a success is pronounced as soon as it finds another unmatched vertex than the one in the root (that is, as soon as it finds an augmenting path). The augmenting path allows for increasing the size of matching. After no such path can be found, the procedure is finished. The algorithm is as follows:

```

findMaximumMatching(bipartite graph)
  for all unmatched vertices  $v$ 
    set level of all vertices to 0;
    set parent of all vertices to null;
    level( $v$ ) = 1;
    last = null;
    clear queue;
    enqueue( $v$ );

```

```

while queue is not empty and last is null
    v = dequeue();
    if level(v) is an odd number
        for all vertices u adjacent to v such that level(u) is 0
            if u is unmatched           // the end of an augmenting
                parent(u) = v;         // path is found;
                last = u;               // this also allows to exit the while loop;
                break;                 // exit the for loop;
            else if u is matched but not with v
                parent(u) = v;
                level(u) = level(v) + 1;
                enqueue(u);
    else // if level(v) is an even number
        enqueue(vertex u matched with v);
        parent(u) = v;
        level(u) = level(v) + 1;
if last is not null // augment matching by updating the augmenting path;
for (u = last; u is not null; u = parent(parent(u)))
    matchedWith(u) = parent(u);
    matchedWith(parent(u)) = u;

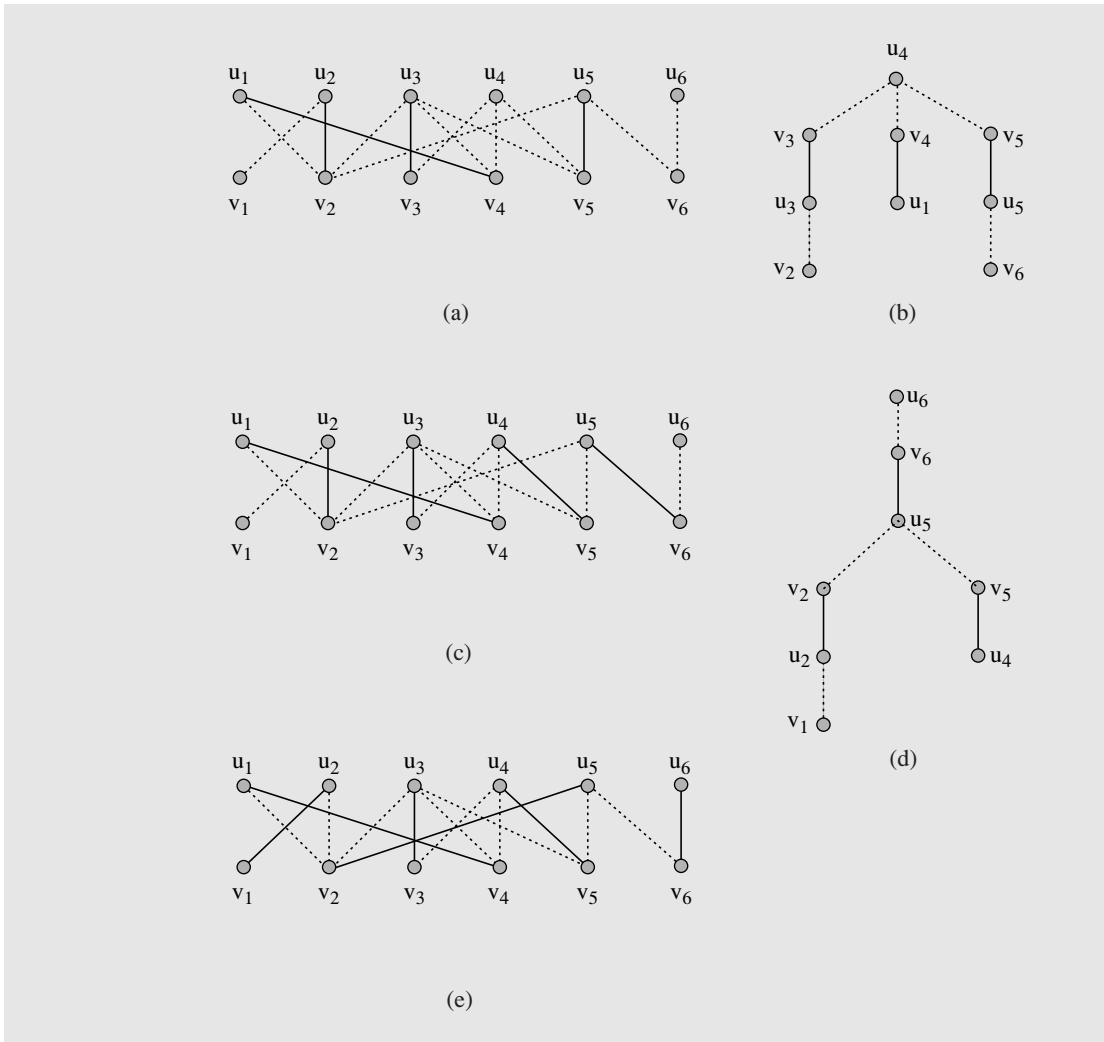
```

An example is shown in Figure 8.30. For the current matching  $M = \{(u_1, v_4), (u_2, v_2), (u_3, v_3), (u_5, v_5)\}$  (Figure 8.30a), we start from vertex  $u_4$ . First, three vertices adjacent to  $u_4$  (namely,  $v_3, v_4$ , and  $v_5$ ) are enqueued, all of them connected to  $u_4$  with edges not in  $M$ . Then  $v_3$  is dequeued, and because it is on an even level of the tree (Figure 8.30b), there is at most one successor to be considered, which is the vertex  $u_3$  because  $edge(u_3v_3)$  is in  $M$  and  $u_3$  is enqueued. Then successors of  $v_4$  and  $v_5$  are found—that is,  $u_1$  and  $u_5$ , respectively—after which the vertex  $u_3$  is considered. This vertex is on an odd level; hence, all vertices directly accessible from it through edges not in  $M$  are checked. There are three such vertices,  $v_2, v_4$ , and  $v_5$ , but only the first is not yet in the tree, so it is included now. Next, successors of  $u_1$  are tested, but the only candidate,  $v_2$ , does not qualify because it is already in the tree. Finally,  $u_5$  is checked, from which we arrive at an unmatched vertex  $v_6$ . This marks the end of an augmenting path; hence, the `while` loop is exited and then matching  $M$  is modified by including in  $M$  the edges in the newly found path that are not in  $M$  and excluding from  $M$  the edges of the path that are there. The path has one more edge in  $M$  than not in  $M$ , so after such modification the number of edges in  $M$  is increased by one. The new matching is shown in Figure 8.30c.

After finding and modifying an augmenting path, a search for another augmenting path begins. Because there are still two unmatched vertices, there still exists a possibility that a larger matching can be found. In the second iteration of the outer `for` loop, we begin with the vertex  $u_6$ , which eventually leads to the tree as in Figure 8.30d that includes an augmenting path, which in turn gives a matching as in Figure 8.30e. There are no unmatched vertices left; thus, the maximum matching just found is also a perfect matching.

Complexity of the algorithm is found as follows. Each alternating path increases the cardinality of matching by one, and because the maximum number of edges in matching  $M$  is  $|V|/2$ , the number of iterations of the outer `for` loop is at most  $|V|/2$ . Moreover, finding one augmenting path requires  $O(|E|)$  steps so that the total cost of finding a maximum matching is  $O(|V||E|)$ .

**FIGURE 8.30** Application of the `findMaximumMatching()` algorithm. Matched vertices are connected with solid lines.



### 8.9.1 Stable Matching Problem

In the example of matching applicants with jobs, any successful maximum matching was acceptable because it did not matter to applicants what job they got and it did not matter to the employers whom they hired. But usually this is not the case. Applicants have their preferences, and so do employers. In the *stable matching problem*, also called the *stable marriage problem*, there are two nonoverlapping sets  $U$  and  $W$  of the

same cardinality. Each element of  $U$  has a ranking list of elements of  $W$ , and each element of  $W$  has a preference list consisting of elements of  $U$ . Ideally, the elements should be matched with their highest preferences, but because of possible conflicts between different lists (for example, the same  $w$  can be first on two ranking lists), a matching should be created that is stable. A matching is *unstable* if two such elements,  $u$  and  $w$ , rank each other higher than the elements with which they are currently matched; otherwise, the matching is *stable*. Consider sets  $U = \{u_1, u_2, u_3, u_4\}$  and  $W = \{w_1, w_2, w_3, w_4\}$  and ranking lists

$u_1: w_2 > w_1 > w_3 > w_4$	$w_1: u_3 > u_2 > u_1 > u_4$
$u_2: w_3 > w_2 > w_1 > w_4$	$w_2: u_1 > u_3 > u_4 > u_2$
$u_3: w_3 > w_4 > w_1 > w_2$	$w_3: u_4 > u_2 > u_3 > u_1$
$u_4: w_2 > w_3 > w_4 > w_1$	$w_4: u_2 > u_1 > u_3 > u_4$

The matching  $(u_1, w_1), (u_2, w_2), (u_3, w_4), (u_4, w_3)$  is unstable because there are two elements,  $u_1$  and  $w_2$ , that prefer each other over the elements with which they are currently matched:  $u_1$  prefers  $w_2$  over  $w_1$  and  $w_2$  prefers  $u_1$  over  $u_2$ .

A classical algorithm to find a stable matching was designed by Gale and Shapley (1962), who also show that a stable matching always exists.

```

stableMatching(graph = (U∪W,M))           // U∩W = null, |U| = |W|, M = null;
while there is an unmatched element u∈U
    w = the highest remaining choice from W on u's list;
    if w is unmatched
        matchedWith(u) = w;                // include edge (uw) in matching M;
        matchedWith(w) = u;
    else if w is matched and w ranks u higher than its current match
        matchedWith(matchedWith(w)) = null; // remove edge (matchedWith(w), w) from M;
        matchedWith(u) = w;                // include edge (uw) in M;
        matchedWith(w) = u;
    
```

Because the list of choices for each  $u \in U$  decreases in each iteration, each list is of length  $|W| = |U|$  and there are  $|U|$  such lists, one for each  $u$ , the algorithm executes  $O(|U|^2)$  iterations:  $|U|$  times in the best case and  $|U|^2$  in the worst case.

Consider an application of this algorithm to the set  $U$  and  $W$  defined before with the specified rankings. In the first iteration,  $u_1$  is chosen and matched immediately with the unmatched  $w_2$  that is highest on  $u_1$ 's ranking list. In the second iteration,  $u_2$  is successfully matched with its highest choice,  $w_3$ . In the third iteration, an attempt is made to match  $u_3$  with its preference,  $w_3$ , but  $w_3$  is already matched and  $w_3$  prefers its current match,  $u_2$ , more than  $u_3$ , so nothing happens. In the fourth iteration,  $u_3$  is matched with its second preference,  $w_4$ , which is currently unmatched. In the fifth iteration, a match is tried for  $u_4$  and  $w_2$ , but unsuccessfully, because  $w_2$  is matched already with  $u_1$ , and  $u_1$  is ranked by  $w_2$  higher than  $u_4$ . In the sixth iteration, a successful attempt is made to match  $u_4$  with its second choice,  $w_3$ ;  $w_3$  is matched with  $u_2$ , but it prefers  $u_4$  over  $u_2$ , so  $u_2$  becomes unmatched and  $u_4$  is matched with  $w_3$ . Now,  $u_2$  has to be matched. The summary of all steps is given in the following table:

Iteration	$u$	$w$	Matched Pairs
1	$u_1$	$w_2$	$(u_1, w_2)$
2	$u_2$	$w_3$	$(u_1, w_2), (u_2, w_3)$
3	$u_3$	$w_3$	$(u_1, w_2), (u_2, w_3)$
4	$u_3$	$w_4$	$(u_1, w_2), (u_2, w_3), (u_3, w_4)$
5	$u_4$	$w_2$	$(u_1, w_2), (u_2, w_3), (u_3, w_4)$
6	$u_4$	$w_3$	$(u_1, w_2), (u_3, w_4), (u_4, w_3)$
7	$u_2$	$w_2$	$(u_1, w_2), (u_3, w_4), (u_4, w_3)$
8	$u_2$	$w_1$	$(u_1, w_2), (u_2, w_1), (u_3, w_4), (u_4, w_3)$

Note that an asymmetry is implied in this algorithm concerning whose rankings are more important. The algorithm is working in favor of elements of set  $U$ . When the roles of sets  $U$  and  $W$  are reversed, then  $w$ 's immediately have their preferred choices and the resulting stable matching is

$$(u_1, w_2), (u_2, w_4), (u_3, w_1), (u_4, w_3)$$

and  $u_2$  and  $u_3$  are matched with  $w$ 's— $w_4$  and  $w_1$ , respectively—that are lower on their ranking lists than the  $w$ 's chosen before— $w_1$  and  $w_4$ , respectively.

### 8.9.2 Assignment Problem

The problem of finding a suitable matching becomes more complicated in a weighted graph. In such a graph, we are interested in finding a matching with the maximum total weight. The problem is called an *assignment problem*. The assignment problem for complete bipartite graphs with two sets of vertices of the same size is called an *optimal assignment problem*.

An  $O(|V|^3)$  algorithm is due to Kuhn (1955) and Munkres (1957) (Bondy and Murty 1976; Thulasiraman and Swamy 1992). For a bipartite graph  $G = (V, E)$ ,  $V = U \cup W$ , we define a labeling function  $f: U \cup W \rightarrow R$  such that a label  $f(v)$  is a number assigned to each vertex  $v$  such that for all vertices  $v, u$ ,  $f(u) + f(v) \geq \text{weight}(\text{edge}(uv))$ . Create a set  $H = \{\text{edge}(uv) \in E: f(u) + f(v) = \text{weight}(\text{edge}(uv))\}$  and then an *equality subgraph*  $G_f = (V, H)$ . The Kuhn-Munkres algorithm is based on the theorem stating that if for a labeling function  $f$  and an equality subgraph  $G_f$  graph  $G$  contains a perfect matching, then this matching is optimal: for any matching  $M$  in  $G$ ,  $\sum f(u) + \sum f(v) \geq \text{weight}(M)$ , for any perfect matching  $M_p$ ,  $\sum f(u) + \sum f(v) = \text{weight}(M_p)$ ; that is,  $\text{weight}(M) \leq \sum f(u) + \sum f(v) = \text{weight}(M_p)$ .

The algorithm expands the equality subgraph  $G_f$  until a perfect matching can be found in it, which will also be an optimal matching for graph  $G$ .

```

optimalAssignment()
   $G_f$  = equality subgraph for some vertex labeling  $f$ ;
   $M$  = matching in  $G_f$ ;
   $S$  = {some unmatched vertex  $u$ }; // beginning of an augmenting path  $P$ ;
   $T$  = null;
  while  $M$  is not a perfect matching

```

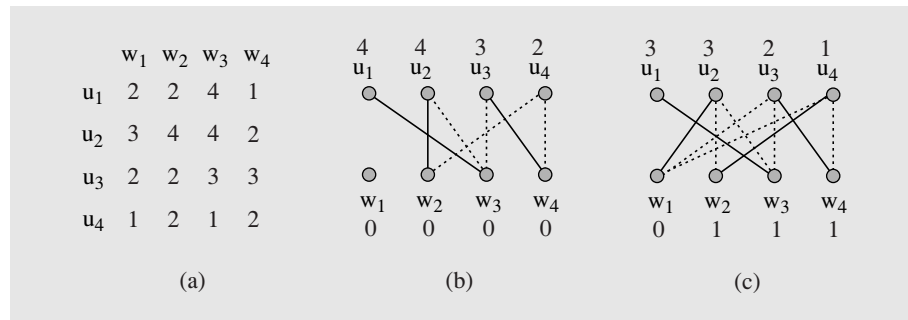
```

 $\Gamma(S) = \{w: \exists u \in S: \text{edge}(uw) \in G_f\}; // \text{ vertices adjacent in } G_f \text{ to the vertices in } S;$ 
if  $\Gamma(S) == T$ 
     $d = \min\{f(u) + f(w) - \text{weight}(\text{edge}(uw)): u \in S, w \notin T\};$ 
    for each vertex  $v$ 
        if  $v \in S$ 
             $f(v) = f(v) - d;$ 
        else if  $v \in T$ 
             $f(v) = f(v) + d;$ 
    construct new equality subgraph  $G_f$  and new matching  $M;$ 
else // if  $T \subset \Gamma(S)$ 
     $w = \text{a vertex from } \Gamma(S) - T;$ 
    if  $w$  is unmatched // the end of the augmenting path  $P;$ 
         $P = \text{augmenting path just found};$ 
         $M = M \oplus P;$ 
         $S = \{\text{some unmatched vertex } u\};$ 
         $T = \text{null};$ 
    else  $S = S \cup \{\text{neighbor of } w \text{ in } M\};$ 
         $T = T \cup \{w\};$ 

```

For an example, see Figure 8.31. A complete bipartite graph  $G = (\{u_1, \dots, u_4\} \cup \{w_1, \dots, w_4\}, E)$  has weights defined by the matrix in Figure 8.31a.

**FIGURE 8.31** An example of application of the `optimalAssignment()` algorithm.



0. For an initial labeling, we choose the function  $f$  such that  $f(u) = \max\{\text{weight}(\text{edge}(uw)): w \in W\}$ ; that is, the maximum weight in the weight matrix in the row for vertex  $u$ , and  $f(w) = 0$ , so that for the graph  $G$ , the initial labeling is as in Figure 8.31b. We choose a matching as in Figure 8.31b and set  $S$  to  $\{u_4\}$  and  $T$  to null.
1. In the first iteration of the `while` loop,  $\Gamma(S) = \{w_2, w_4\}$ , because both  $w_2$  and  $w_4$  are neighbors of  $u_4$ , which is the only element of  $S$ . Because  $T \subset \Gamma(S)$ —that is,  $\emptyset \subset \{w_2, w_4\}$ —the outer `else` clause is executed, whereby  $w = w_2$  (we simply choose the first element if  $\Gamma(S)$  not in  $T$ ), and because  $w_2$  is matched, the inner `else` clause is executed, in which we extend  $S$  to  $\{u_2, u_4\}$ , because  $u_2$  is both matched and adjacent to  $w_2$ , and extend  $T$  to  $\{w_2\}$ .

All the iterations are summarized in the following table.

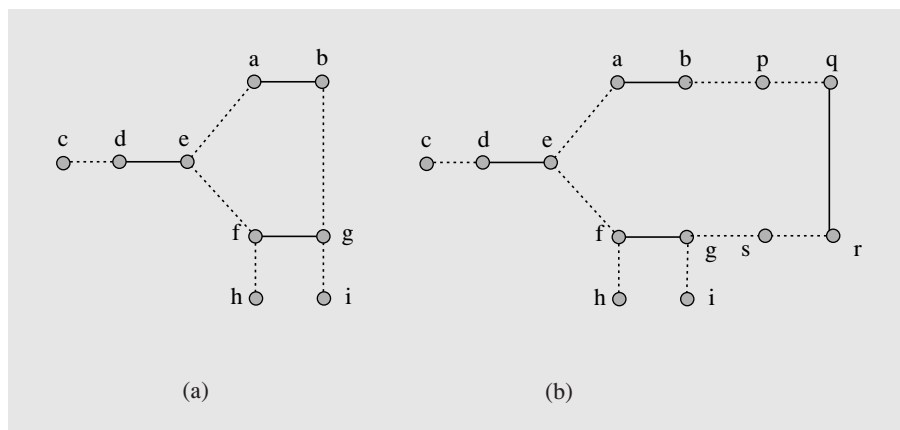
Iteration	$\Gamma(S)$	$w$	$S$	$T$
0	$\emptyset$		$\{u_4\}$	$\emptyset$
1	$\{w_2, w_4\}$	$w_2$	$\{u_2, u_4\}$	$\{w_2\}$
2	$\{w_2, w_3, w_4\}$	$w_3$	$\{u_1, u_2, u_4\}$	$\{w_2, w_3\}$
3	$\{w_2, w_3, w_4\}$	$w_4$	$\{u_1, u_2, u_3, u_4\}$	$\{w_2, w_3, w_4\}$
4	$\{w_2, w_3, w_4\}$			

In the fourth iteration, the condition of the outer `if` statement becomes true because sets  $T$  and  $\Gamma(S)$  are now equal, so the distance  $d = \min\{f(u) + f(w) - \text{weight}(\text{edge}(uw)) : u \in S, w \notin T\}$  is computed. Because  $w_1$  is the only vertex not in  $T = \{w_2, w_3, w_4\}$ ,  $d = \min\{f(u) + f(w_1) - \text{weight}(\text{edge}(uw_1)) : u \in S = \{u_1, u_2, u_3, u_4\}\} = \min\{(4 + 0 - 2), (4 + 0 - 3), (3 + 0 - 2), (2 + 0 - 1)\} = 1$ . With this distance, the labels of vertices in graph  $G$  are updated to become labels in Figure 8.31c. The labels of all four vertices in  $S$  are decremented by  $d = 1$ , and all three vertices in  $T$  are incremented by the same value. Next, an equality subgraph is created that includes all the edges, as in Figure 8.31c, and then the matching is found that includes edges drawn with solid lines. This is a perfect matching, and hence, an optimal assignment, which concludes the execution of the algorithm.

### 8.9.3 Matching in Nonbipartite Graphs

The algorithm `findMaximumMatching()` is not general enough to properly process nonbipartite graphs. Consider the graph in Figure 8.32a. If we start building a tree using breadth-first search to determine an augmenting path from vertex  $c$ , then vertex  $d$  is on an even level, vertex  $e$  is on an odd level, and vertices  $a$  and  $f$  are on an even level. Next,  $a$  is expanded by adding  $b$  to the tree and then  $f$  by including  $i$  in the tree so that an augmenting path  $c, d, e, f, g, i$  is found. However, if vertex  $i$  were not in the graph, then the only augmenting path  $c, d, e, a, b, g, f, h$  could not be detected because

**FIGURE 8.32** Application of the `findMaximumMatching()` algorithm to a nonbipartite graph.





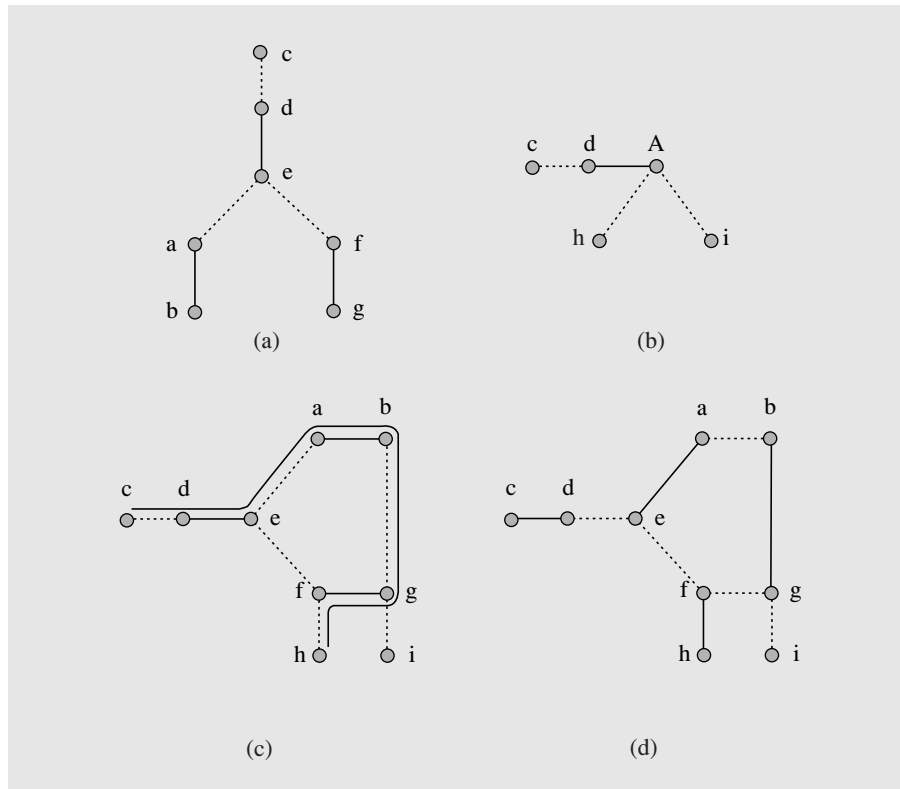
vertex  $g$  has been labeled, and as such it blocks access to  $f$  and consequently to vertex  $h$ . The path  $c, d, e, a, b, g, f, h$  could be found if we used a depth-first search and expanded the path leading through  $a$  before expanding a path leading through  $f$ , because the search would first determine the path  $c, d, e, a, b, g, f$ , and then it would access  $h$  from  $f$ . However, if  $h$  was not in the graph, then the very same depth-first search would miss the path  $c, d, e, f, g, i$  because first the path  $c, d, e, a, b, g, f$  with vertices  $g$  and  $f$  would be expanded so that the detection of path  $c, d, e, f, g, i$  is ruled out.

A source of the problem is the presence of cycles with an odd number of edges. But it is not just the odd number of edges in a cycle that causes the problem. Consider the graph in Figure 8.32b. The cycle  $e, a, b, p, q, r, s, g, f, e$  has nine edges, but `findMaximumMatching()` is successful here, as the reader can easily determine (both depth-first search and breadth-first search first find path  $c, d, e, a, b, p$  and then path  $h, f, g, i$ ). The problem arises in a special type of cycle with an odd number of edges, which are called blossoms. The technique of determining augmenting paths for graphs with blossoms is due to Jack Edmonds. But first some definitions.

A *blossom* is an alternating cycle  $v_1, v_2, \dots, v_{2k-1}, v_1$  such that  $edge(v_1, v_2)$  and  $edge(v_{2k-1}, v_1)$  are not in matching. In such a cycle, the vertex  $v_1$  is called the *base* of the blossom. An even length alternating path is called a *stem*; a path of length zero that has only one vertex is also a stem. A blossom with a stem whose edge in matching is incident with the base of the blossom is called a *flower*. For example, in Figure 8.32a, path  $c, d, e$  and path  $e$  are stems, and cycle  $e, a, b, g, f, e$  is a blossom with the base  $e$ .

The problems with blossoms arise if a prospective augmenting path leads to a blossom through the base. Depending on which edge is chosen to continue the path, we may or may not obtain an augmenting path. However, if the blossom is entered through any other vertex  $v$  than the base, the problem does not arise because we can choose only one of the two edges of  $v$ . Hence, an idea is to prevent a blossom from possibly harmful effects by detecting the fact that a blossom is being entered through its base. The next step is to temporarily remove the blossom from the graph by putting in place of its base a vertex that represents such a blossom and to attach to this vertex all edges connected to the blossom. The search for an augmenting path continues, and if an augmenting path that includes a vertex representing a blossom is found, the blossom is expanded and the path through it is determined by going backward from the edge that leads to the blossom to one of the edges incident with the base.

The first problem is how to recognize that a blossom has been entered through the base. Consider the Hungarian tree in Figure 8.33a, which is generated using breadth-first search in the graph in Figure 8.32a. Now, if we try to find neighbors of  $b$ , then only  $g$  qualifies because  $edge(ab)$  is in matching, and thus only edges not in matching can be included starting from  $b$ . Such edges would lead to vertices on an even level of the tree. But  $g$  has already been labeled and it is located on an odd level. This marks a blossom detection. If a labeled vertex is reached through different paths, one of them requiring this vertex to be on an even level and another on a odd level, then we know that we are in the middle of a blossom entered through its base. Now we trace the paths from  $g$  and  $b$  back in the tree until a common root is found. This common root, vertex  $e$  in our example, is the base of the detected blossom. The blossom is now replaced by a vertex  $A$ , which leads to a transformed graph, as in Figure 8.33b. The search for an augmenting path restarts from vertex  $A$  and continues until such a path is found, namely, path  $c, d, A, h$ . Now we expand the blossom represented

**FIGURE 8.33** Processing a graph with a blossom.

by  $A$  and trace the augmenting path through the blossom. We do that by starting from  $edge(hA)$ , which is now  $edge(hf)$ . Because it is an edge not in matching, then from  $f$  only  $edge(fg)$  can be chosen so that the augmenting path can be alternating. Moving through vertices  $f, g, b, a, e$ , we determine the part of the augmenting path,  $c, d, A, h$ , which corresponds to  $A$  (Figure 8.33c) so that the full augmenting path is  $c, d, e, a, b, g, f, h$ . After the path is processed, we obtain a new matching, as in Figure 8.33d.

## 8.10 EULERIAN AND HAMILTONIAN GRAPHS

### 8.10.1 Eulerian Graphs

An *Eulerian trail* in a graph is a path that includes all edges of the graph only once. An *Eulerian cycle* is a cycle that is also an Eulerian trail. A graph that has an Eulerian cycle is called an *Eulerian graph*. A theorem proven by Euler (pronounced: oiler) says that a graph is Eulerian if every vertex of the graph is incident to an even number of edges. Also, a graph contains an Eulerian trail if it has exactly two vertices incident with an odd number of edges.

The oldest algorithm that allows us to find an Eulerian cycle if this is possible is due to Fleury (1883). The algorithm takes great care in not traversing a bridge—that is, an edge whose removal would disconnect the graphs  $G_1$  and  $G_2$ —because if traversal of  $G_1$  is not completed before traversing such an edge to pass to  $G_2$ , it would not be possible to return to  $G_1$ . As Fleury himself phrases it, the algorithm consists in “taking an isolating path (= a bridge) only when there is no other path to take.” Only after the entire subgraph  $G_1$  has been traversed can the path lead through such an edge. Fleury’s algorithm is as follows:

```

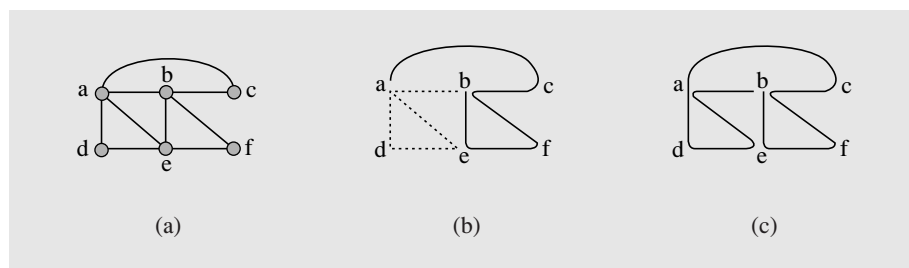
FleuryAlgorithm(undirected graph)
  v = a starting vertex; // any vertex;
  path = v;
  untraversed = graph;
  while v has untraversed edges
    if edge(vu) is the only one untraversed edge
      e = edge(vu);
      remove v from untraversed;
    else e = edge(vu) which is not a bridge in untraversed;
    path = path + u;
    remove e from untraversed;
    v = u;
  if untraversed has no edges
    success;
  else failure;

```

Note that for cases when a vertex has more than one untraversed edge, a connectivity checking algorithm should be applied.

An example of finding an Eulerian cycle is shown in Figure 8.34. It is critical that before an edge is chosen, a test is made to determine whether the edge is a bridge in the untraversed subgraph. For example, if in the graph in Figure 8.34a the traversal begins in vertex  $b$  to reach vertex  $a$  through vertices  $e, f$ , and  $d$ , and  $c$ , thereby using the path  $b, e, f, b, c, a$ , then we need to be careful which untraversed edge is chosen in  $a$ :  $edge(ab)$ ,  $edge(ad)$ , or  $edge(ae)$  (Figure 8.34b). If we choose  $edge(ab)$ , then the remaining three untraversed edges are unreachable, because in the yet untraversed subgraph  $untraversed = (\{a, b, d, e\}, \{edge(ab), edge(ad), edge(ae), edge(de)\})$ ,  $edge(ab)$  is a bridge because it disconnects two subgraphs of  $untraversed$ ,  $(\{a, d, e\}, \{edge(ad), edge(ae), edge(de)\})$  and  $(\{b\}, \emptyset)$ .

**FIGURE 8.34** Finding an Eulerian cycle.



### The Chinese Postman Problem

The *Chinese postman problem* is stated as follows: A postman picks up mail at the post office, delivers the mail to houses in a certain area, and returns to the post office (Kwan, 1962). The walk should have a shortest distance when traversing each street at least once. The problem can be modeled with a graph  $G$  whose edges represent streets and their lengths and vertices represent street corners in which we want to find a minimum closed walk. Let us observe first that if the graph  $G$  is Eulerian, then each Eulerian cycle gives a solution; however, if the graph  $G$  is not Eulerian, then it can be so amplified that it becomes an Eulerian graph  $G^*$  in which every edge  $e$  appears as many times as the number of times it is used in the postman's walk. If so, we want to construct such a graph  $G^*$  in which the sum of distances of the added edges is minimal. First, odd-degree vertices are grouped into pairs  $(u, w)$  and a path of new edges is added to an already existing path between both vertices of each pair, thereby forming the graph  $G^*$ . The problem consists now in so grouping the odd-degree vertices that the total distance of the added paths is minimum. The following algorithm for solving this problem is due to Edmonds and Johnson (Edmonds, 1965; Edmonds and Johnson, 1973; see Gibbons, 1985).

```

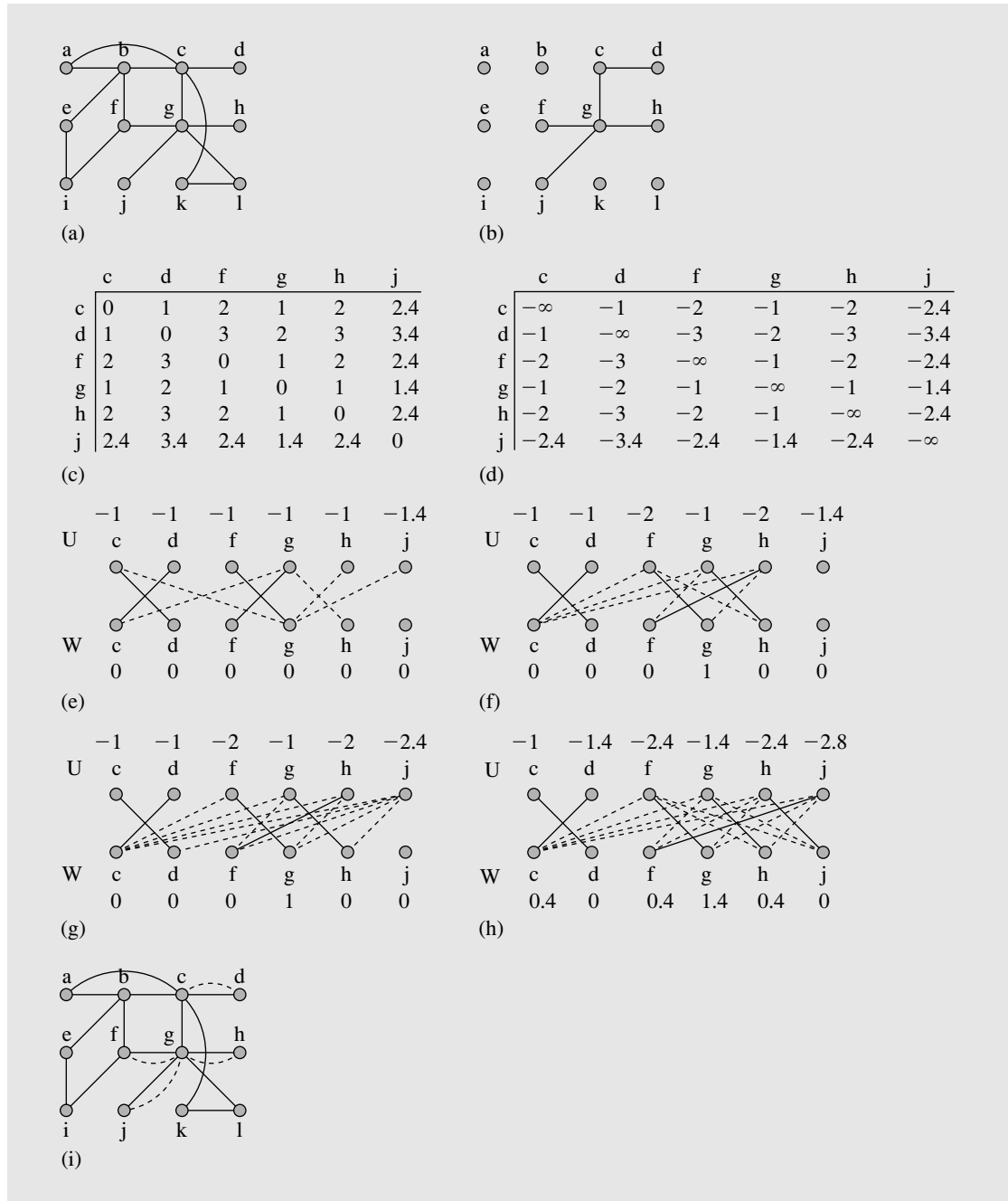
ChinesePostmanTour( $G = (V, E)$ )
  ODD = set of all odd-degree vertices of  $G$ ;
  if ODD is not empty
     $E^* = E$ ;
     $G^* = (V, E^*)$ ;
    find the shortest paths between all pairs of odd-degree vertices;
    construct a complete bipartite graph  $H = (U \cup W, E')$ ,  $ODD = (v_1, \dots, v_{2k})$ , such that
       $U = (u_1, \dots, u_{2k})$  and  $u_i$  is a copy of  $v_i$ ;
       $W = (w_1, \dots, w_{2k})$  and  $w_i$  is a copy of  $v_i$ ;
       $dist(edge(u_i w_i)) = -\infty$ ;
       $dist(edge(u_i w_j)) = -dist(edge(v_i v_j))$  for  $i \neq j$ ;
    find optimal assignment  $M$  in  $H$ ;
    for each edge  $(u_i w_j) \in M$  such that  $v_i$  is still an odd-degree vertex
       $E^* = E^* \cup \{edge(uw) \in path(u_i w_j) : path(u_i w_j) \text{ is minimum}\}$ ;
  find Eulerian path in  $G^*$ ;

```

Note that the number of odd-degree vertices is even (Exercise 44).

A process of finding a postman tour is illustrated in Figure 8.35. The graph in Figure 8.35a has six odd-degree vertices,  $ODD = \{c, d, f, g, h, j\}$ . The shortest paths between all pairs of these vertices are determined (Figure 8.35b–c) and then a complete bipartite graph  $H$  is found (Figure 8.35d). Next, an optimal assignment  $M$  is found. By using the `optimalAssignment()` algorithm (Section 8.9.1), a matching in an initial equality subgraph is found (Figure 8.35e). The algorithm finds two matchings, as in Figure 8.35f–g, and then a perfect matching, as in Figure 8.35h. Using this matching, the original graph is amplified by adding new edges, shown as dashed lines in Figure 8.35i, so that the amplified graph has no odd-degree vertices, and thus finding an Eulerian trail is possible.

**FIGURE 8.35** Solving the Chinese postman problem.



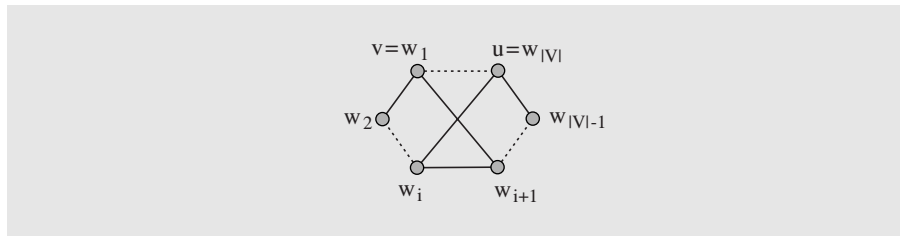
### 8.10.2 Hamiltonian Graphs

A *Hamiltonian cycle* in a graph is a cycle that passes through all the vertices of the graph. A graph is called a *Hamiltonian graph* if it includes at least one Hamiltonian cycle. There is no formula characterizing a Hamiltonian graph. However, it is clear that all complete graphs are Hamiltonian.

**Theorem** (Bondy and Chvátal, 1976; Ore, 1960). If  $edge(vu) \notin E$ , graph  $G^* = (V, E \cup \{edge(vu)\})$  is Hamiltonian, and  $deg(v) + deg(u) \geq |V|$ , then graph  $G = (V, E)$  is also Hamiltonian.

**Proof.** Consider a Hamiltonian cycle in  $G^*$  that includes  $edge(vu) \notin E$ . This implies that  $G$  has a Hamiltonian path  $v = w_1, w_2, \dots, w_{|V|-1}, w_{|V|} = u$ . Now we want to find two crossover edges,  $edge(vw_{i+1})$  and  $edge(w_i u)$ , such that  $w_1, w_{i+1}, w_{i+2}, \dots, w_{|V|}, w_i, w_2, w_1$  is a Hamiltonian cycle in  $G$  (see Figure 8.36). To see that this is possible, consider a set  $S$  of subscripts of neighbors of  $v$ ,  $S = \{j: edge(vw_{j+1})\}$ , and a set  $T$  of subscripts of neighbors of  $u$ ,  $T = \{j: edge(w_j u)\}$ . Because  $S \cup T \subseteq \{1, 2, \dots, |V| - 1\}$ ,  $|S| = deg(v)$ ,  $|T| = deg(u)$ , and  $deg(v) + deg(u) \geq |V|$ , then  $S$  and  $T$  must have a common subscript so that the two crossover edges,  $edge(vw_{i+1})$  and  $edge(w_i u)$ , exist.  $\square$

**FIGURE 8.36** Crossover edges.



The theorem, in essence, says that some Hamiltonian graphs allow us to create Hamiltonian graphs by eliminating some of their edges. This leads to an algorithm that first expands a graph to a graph with more edges in which finding a Hamiltonian cycle is easy, and then manipulates this cycle by adding some edges and removing other edges so that eventually a Hamiltonian cycle is formed that includes the edges that belong to the original graph. An algorithm for finding Hamiltonian cycles based on the preceding theorem is as follows (Chvátal, 1985):

```

HamiltonianCycle(graph G = (V, E))
  set label of all edges to 0;
  k = 1;
  H = E;
  GH = G;
  while GH contains nonadjacent vertices v, u such that degGH(v) + degGH(u) ≥ |V|
    H = H ∪ {edge(vu)};

```

```

GH = (V, H);
label(edge(vu)) = k++;
if there exists a Hamiltonian cycle C
while (k = max{label(edge(pq)) : edge(pq) ∈ C} > 0
    C = a cycle due to a crossover with each edge labeled by a number < k;

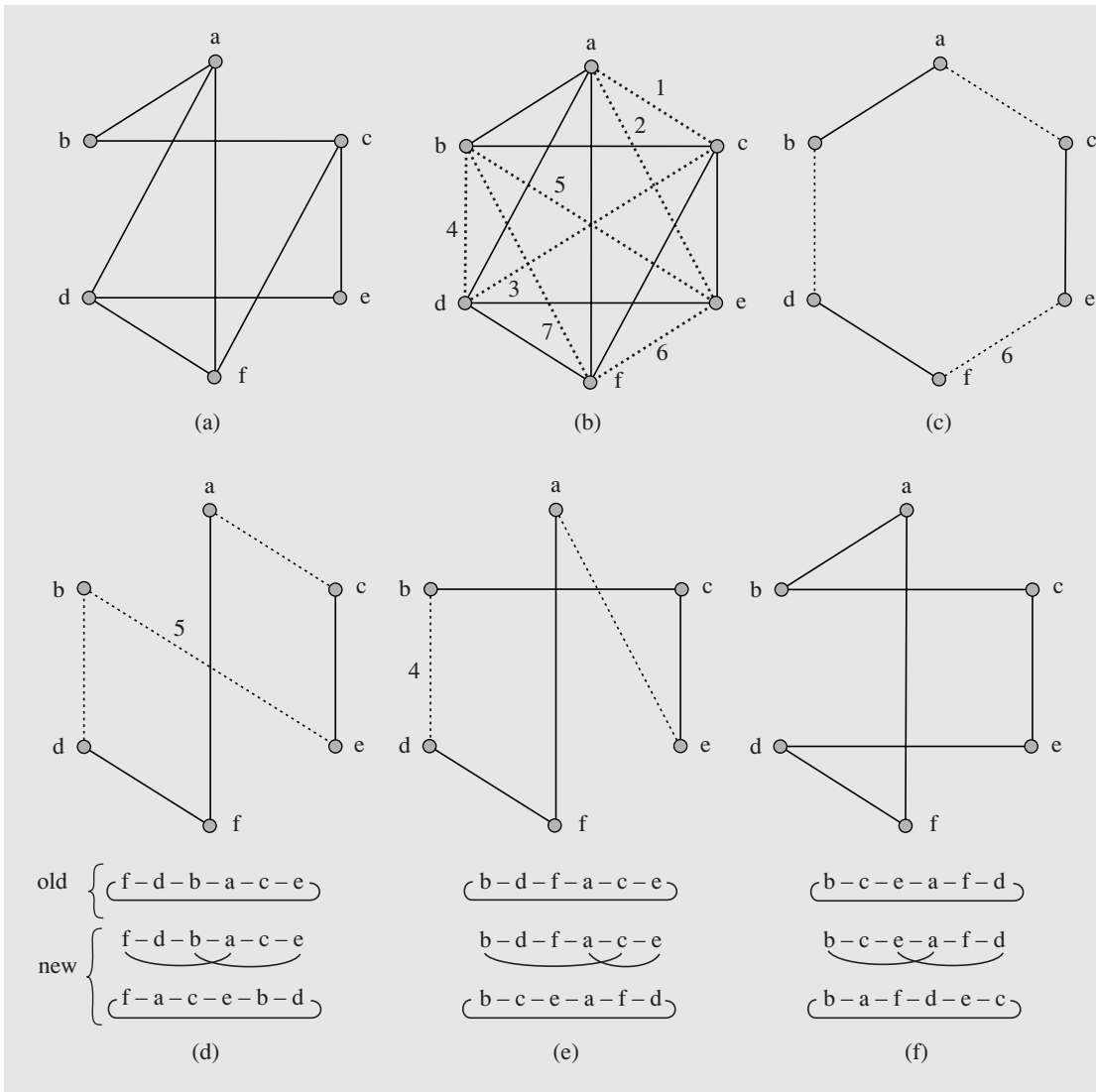
```

Figure 8.37 contains an example. In the first phase, the `while` loop is executed to create graph  $G_H$  based on graph  $G$  in Figure 8.37a. In each iteration, two nonadjacent vertices are connected with an edge if the total number of their neighbors is not less than the number of all vertices in the graph. We first look at all the vertices not adjacent to  $a$ . For vertex  $c$ ,  $\deg_{G_H}(a) + \deg_{G_H}(c) = 6 \geq |V| = 6$ , the  $\text{edge}(ac)$  labeled with number 1 is included in  $H$ . Next, vertex  $e$  is considered, and because the degree of  $a$  just increased by acquiring a new neighbor,  $b$ ,  $\deg_{G_H}(a) + \deg_{G_H}(e) = 6$ , so the  $\text{edge}(ae)$  labeled with 2 is included in  $H$ . The next vertex, for which we try to establish new neighbors, is  $b$  of degree 2, for which there are three nonadjacent vertices,  $d$ ,  $e$ , and  $f$  with degrees 3, 3, and 3, respectively; therefore, the sum of  $b$ 's degree and a degree of any of the three vertices does not reach 6, and no edge is now included in  $H$ . In the next iterations of the `while` loop, all possible neighbors of vertices  $c$ ,  $d$ ,  $e$ , and  $f$  are tested, which results in graph  $H$  as in Figure 8.37b with new edges shown as dashed lines with their labels.

In the second phase of `HamiltonianCycle()`, a Hamiltonian cycle in  $H$  is found,  $a, c, e, f, d, b, a$ . In this cycle, an edge with the highest label is found,  $\text{edge}(ef)$  (Figure 8.37c). The vertices in the cycle are so ordered that the vertices in this edge are on the extreme ends. Then by moving left to right in this sequence of vertices, we try to find crossover edges by checking edges from two neighbor vertices to the vertices at the ends of the sequence so that the edges cross each other. The first possibility is vertices  $d$  and  $b$  with  $\text{edge}(bf)$  and  $\text{edge}(de)$ , but this pair is rejected because the label of  $\text{edge}(bf)$  is greater than the largest label of the current cycle, 6. After this, the vertices  $b$  and  $a$  and the edges connecting them to the ends of the sequence  $\text{edge}(af)$  and  $\text{edge}(be)$  are checked; the edges are acceptable (their labels are 0 and 5), so the old cycle  $f, d, b, a, c, e, f$  is transformed into a new cycle  $f, a, c, e, b, d, f$ . This is shown beneath the diagram in Figure 8.37d with two new edges crossing each other and also in a sequence and in the diagram in Figure 8.37d.

In the new cycle,  $\text{edge}(be)$  has the highest label, 5, so the cycle is presented with the vertices of this edge,  $b$  and  $e$ , shown as the extremes of the sequence  $b, d, f, a, c, e$  (Figure 8.37e). To find crossover edges, we first investigate the pair of crossover edges,  $\text{edge}(bf)$  and  $\text{edge}(de)$ , but the label of  $\text{edge}(bf)$ , 7, is greater than the largest label of the current Hamiltonian cycle, 5, so the pair is discarded. Next, we try the pair  $\text{edge}(ab)$  and  $\text{edge}(ef)$ , but because of the magnitude of label of  $\text{edge}(ef)$ , 6, the pair is not acceptable. The next possibility is the pair  $\text{edge}(bc)$  and  $\text{edge}(ae)$ , which is acceptable, so a new cycle is formed,  $b, c, e, a, f, d, b$  (Figure 8.37e). In this cycle, a pair of crossover edges is found,  $\text{edge}(ab)$  and  $\text{edge}(de)$ , and a new cycle is formed,  $b, a, f, d, e, c$  (Figure 8.37f), which includes edges only with labels equal to 0 (that is, only edges from graph  $G$ ), which marks the end of execution of the algorithm with the last cycle being Hamiltonian and built only from edges in  $G$ .

**FIGURE 8.37** Finding a Hamiltonian cycle.



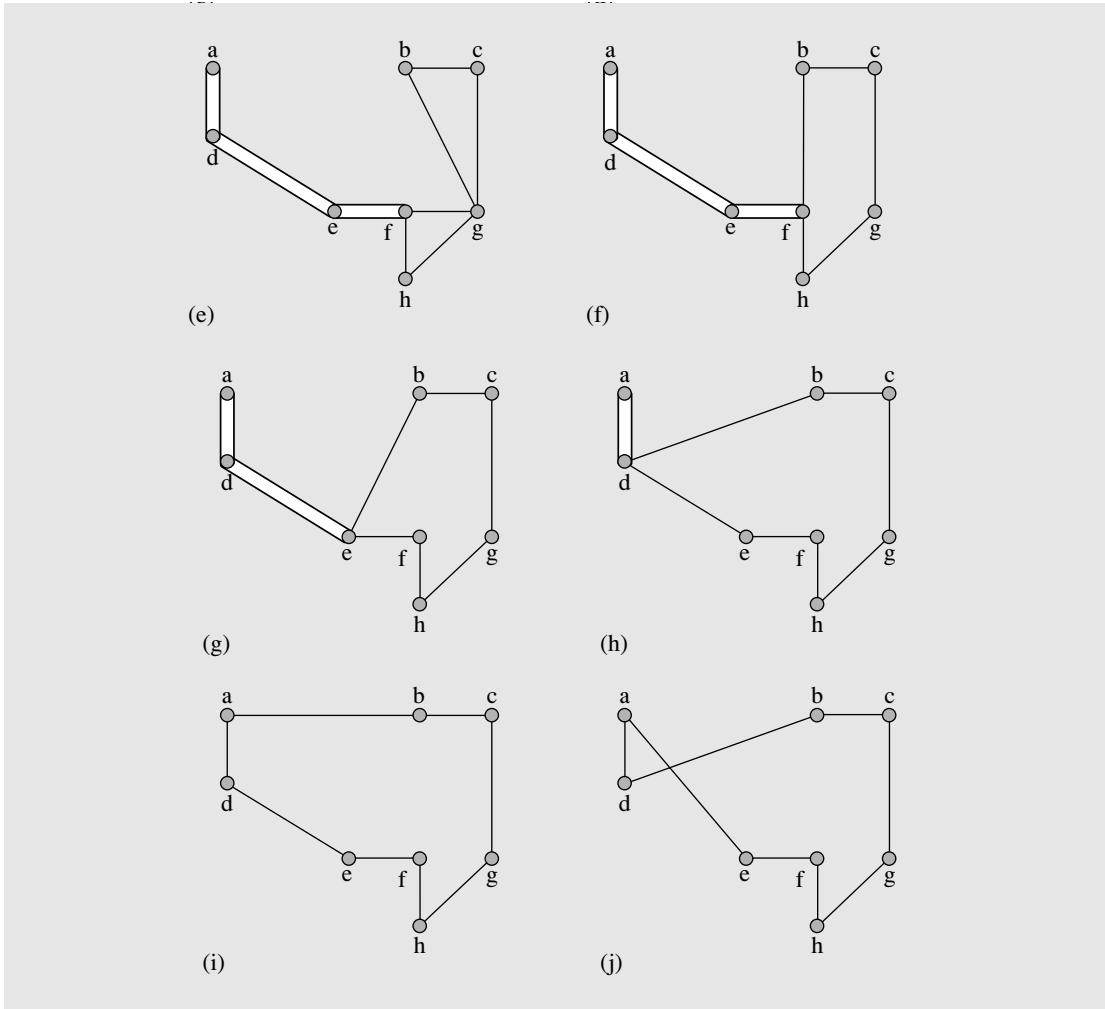
**The Traveling Salesman Problem**

The *traveling salesman problem* (TSP) consists in finding a minimum tour; that is, in visiting once each city from a set of cities and then returning home so that the total distance traveled by the salesman is minimal. If distances between each pair of  $n$  cities are known, then there are  $(n - 1)!$  possible routes (the number of permutations of the vertices starting with a vertex  $v_1$ ) or tours (or  $\frac{(n - 1)!}{2}$  if two tours traveled in opposite directions are equated). The problem is then in finding a minimum Hamiltonian cycle.





**FIGURE 8.38** (continued)



(Figure 8.38c–i), the path is transformed into the path in Figure 8.38i in which each city is visited only once. This final path can be obtained directly from the minimum spanning tree in Figure 8.38b by using the preorder tree traversal of this tree, which generates a salesman tour by connecting vertices in the order determined by the traversal and the vertex visited last with the root of the tree. The tour in Figure 8.38i is obtained by considering vertex *a* as the root of the tree, whereby the cities are in the order *a, d, e, f, h, g, c, b*, after which we return to *a* (Figure 8.38i). Note that the salesman tour in Figure 8.38i is minimum, which is not always the case. When vertex *d* is considered the root of the minimum spanning tree, then preorder traversal renders the path in Figure 8.38j, which clearly is not minimum.

In a version of this algorithm, we extend one tour by adding to it the closest city. Because the tour is kept in one piece, it bears resemblance to the Jarník-Prim method.

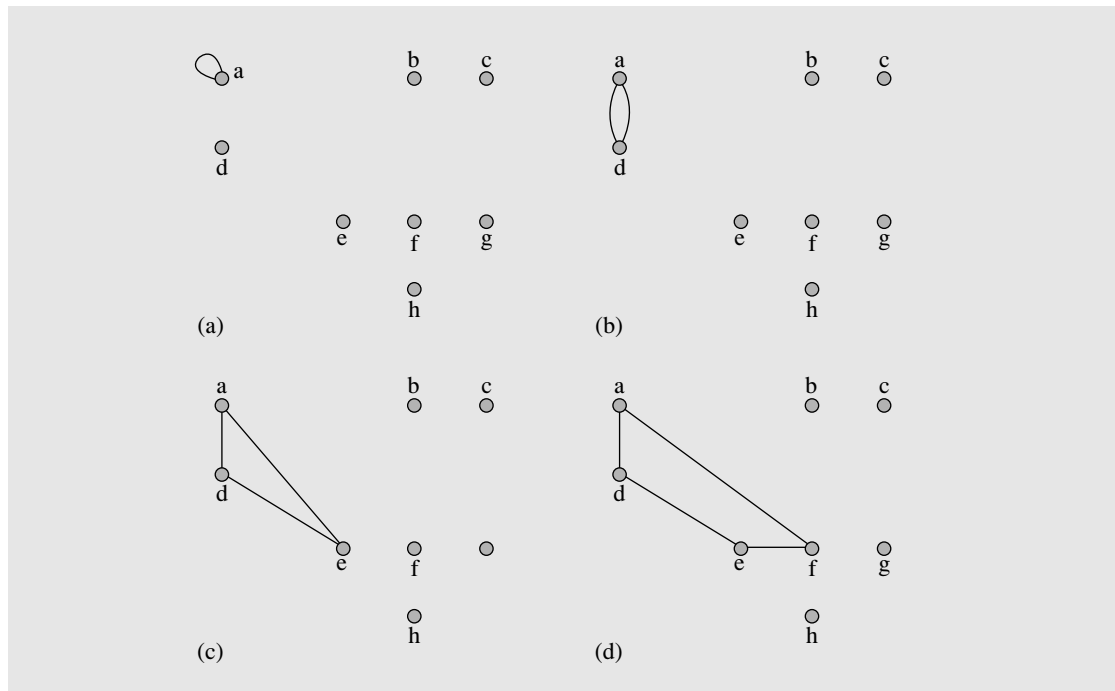
```

nearestAdditionAlgorithm(cities V)
tour = {edge(vv)} for some v;
while tour has less than |V| edges
    vi = a vertex not on the tour closest to it;
    vp = a vertex on the tour closest to vi (edge(vpvi) ∉ tour);
    vq = a vertex on the tour such that edge(vpvq) ∈ tour;
    tour = tour ∪ {edge(vpvi), edge(vivq)} - {edge(vpvq)};
    
```

In this algorithm,  $edge(v_p v_q)$  is one of two edges that connects the city  $v_p$  on the tour to one of its two neighbors  $v_q$  on the tour. An example application of the algorithm is presented in Figure 8.39.

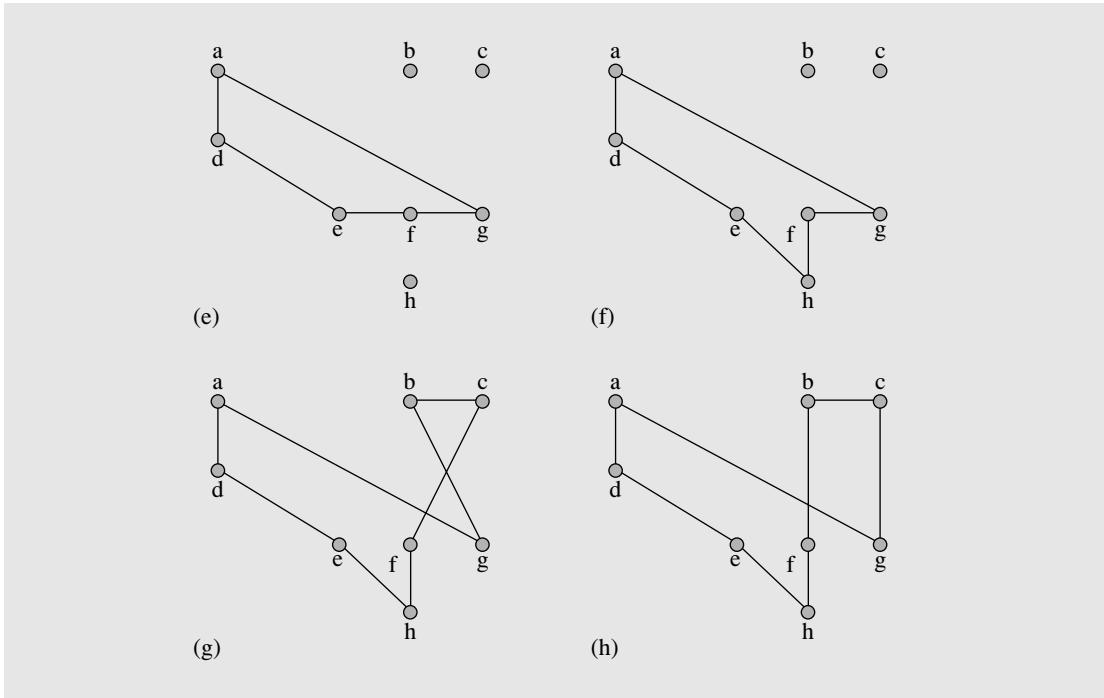
It may appear that the cost of execution of this algorithm is rather high. To find  $v_i$  and  $v_p$  in one iteration, all combinations should be tried, which is  $(\sum_{i=1}^{|V|-1} i(|V| - i)) = \frac{(|V| - 1)|V|(|V| + 1)}{6} = O(|V|^3)$ . However, a speedup is possible by carefully structuring the data. After the first vertex  $v$  is determined and used to initialize the tour, distances from each other vertex  $u$  to  $v$  are found, and two fields are

**FIGURE 8.39** Applying the nearest insertion algorithm to the cities in Figure 8.38a.



Continues

FIGURE 8.39 (continued)



properly set up for  $u$ : the field  $distance = distance(uv)$  and  $distanceTo = v$ ; at the same time, a vertex  $v_{min}$  with the minimum distance is determined. Then, in each iteration,  $v_p = v_{min}$  from the previous iteration. Next, each vertex  $u$  not on the tour is checked to learn whether  $distance(uv_p)$  is smaller than  $distance(uv_r)$  for a vertex  $v_r$  already on the tour. If so, the distance field in  $u$  is updated, as is the field  $distanceTo = v_p$ . At the same time, a vertex  $v_{min}$  with the minimum distance is determined. In this way, the overall cost is  $\sum_{i=1}^{|V|-1} t_i$ , which is  $O(|V|^2)$ .

## 8.11 GRAPH COLORING

Sometimes we want to find a minimum number of nonoverlapping sets of vertices, where each set includes vertices that are *independent*—that is, they are not connected by any edge. For example, there are a number of tasks and a number of people performing these tasks. If one task can be performed by one person at one time, the tasks have to be scheduled so that performing them is possible. We form a graph in which the tasks are represented by vertices; two tasks are joined by an edge if the same person is needed to perform them. Now we try to construct a minimum number of sets of independent tasks. Because tasks in one set can be performed concurrently, the number of sets indicates the number of time slots needed to perform all the tasks.

In another version of this example, two tasks are joined by an edge if they cannot be performed at the same time. Each set of independent tasks represents the sets that can be performed concurrently, but this time the minimum number of sets indicates the minimum number of people needed to perform the tasks. Generally, we join by an edge two vertices when they are not allowed to be members of the same class. The problem can be rephrased by saying that we assign colors to vertices of the graph so that two vertices joined by an edge have different color, and the problem amounts to *coloring* the graph with the minimum number of colors. More formally, if we have a set of colors  $C$  then we wish to find a function  $f:V \rightarrow C$  such that if there is an edge  $(vw)$ , then  $f(v) \neq f(w)$ , and also  $C$  is of minimum cardinality. The minimum number of colors used to color the graph  $G$  is called the *chromatic number* of  $G$  and is denoted  $\chi(G)$ . A graph for which  $k = \chi(G)$  is called *k-colorable*.

There may be more than one minimum set of colors  $C$ . No general formula exists for the chromatic number of any arbitrary graph. For some special cases, however, the formula is rather easy to determine: for a complete graph  $K_n$ ,  $\chi(K_n) = n$ ; for a cycle  $C_{2n}$  with an even number of edges,  $\chi(C_{2n}) = 2$ ; for a cycle  $C_{2n+1}$  with an odd number of edges,  $\chi(C_{2n+1}) = 3$ ; and for a bipartite graph  $G$ ,  $\chi(G) \leq 2$ .

Determining a chromatic number of a graph is an NP-complete problem. Therefore, methods should be used that can approximate the exact graph coloring reasonably well—that is, methods that allow for coloring a graph with the number of colors that is not much larger than the chromatic number.

One general approach, called *sequential coloring*, is to establish the sequence of vertices and a sequence of colors before coloring them, and then color the next vertex with the lowest number possible.

```
sequentialColoringAlgorithm(graph = (V, E))
  put vertices in a certain order  $v_{p_1}, v_{p_2}, \dots, v_{p_v}$ ;
  put colors in a certain order  $c_{p_1}, c_2, \dots, c_k$ ;
  for i = 1 to |V|
    j = the smallest index of color that does not appear in any neighbor of  $v_{p_i}$ ;
    color( $v_{p_i}$ ) =  $c_j$ ;
```

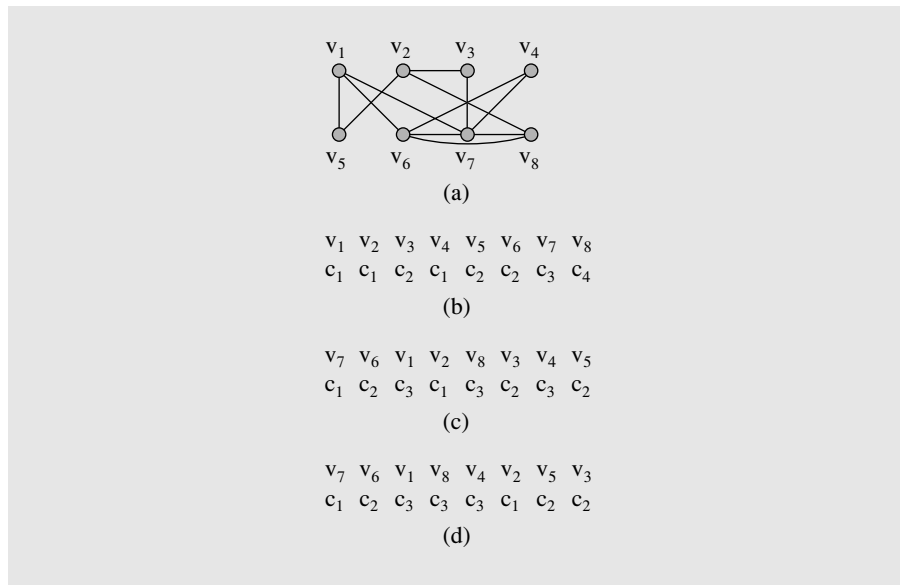
The algorithm is not specific about the criteria by which vertices are ordered (the order of colors is immaterial). One possibility is to use an ordering according to indices already assigned to the vertices before the algorithm is invoked, as in Figure 8.40b, which gives a  $O(|V|^2)$  algorithm. The algorithm, however, may result in a number of colors that is vastly different from the chromatic number for a particular graph.

**Theorem** (Welsh and Powell 1967). For the sequential coloring algorithm, the number of colors needed to color the graph,  $\chi(G) \leq \max_i \min(i, \deg(v_{p_i}) + 1)$ .

**Proof.** When coloring the  $i$ th vertex, at most  $\min(i - 1, \deg(v_{p_i}))$  of its neighbors already have colors; therefore, its color is at most  $\min(i, \deg(v_{p_i}) + 1)$ . Taking the maximum value over all vertices renders the upper bound. □

For the graph in Figure 8.40a,  $\chi(G) \leq \max_i \min(i, \deg(v_{p_i}) + 1) = \max(\min(1, 4), \min(2, 4), \min(3, 3), \min(4, 3), \min(5, 3), \min(6, 5), \min(7, 6), \min(8, 4)) = \max(1, 2, 3, 3, 3, 5, 6, 4) = 6$ .

**FIGURE 8.40** (a) A graph used for coloring; (b) colors assigned to vertices with the sequential coloring algorithm that orders vertices by index number; (c) vertices are put in the largest first sequence; (d) graph coloring obtained with the Brélaz algorithm.



The theorem suggests that the sequence of vertices should be organized so that vertices with high degrees should be placed at the beginning of the sequence so that  $\min(\text{position in sequence}, \deg(v)) = \text{position in sequence}$ , and the vertices with low degree should be placed at the end of the sequence so that  $\min(\text{position in sequence}, \deg(v)) = \deg(v)$ . This leads to the *largest first* version of the algorithm in which the vertices are ordered in descending order according to their degrees. In this way, the vertices from Figure 8.40a are ordered in the sequence  $v_7, v_6, v_1, v_2, v_8, v_3, v_4, v_5$ , where the vertex  $v_7$ , with the largest number of neighbors, is colored first, as shown in Figure 8.40c. This ordering also gives a better estimate of the chromatic number, because now  $\chi(G) \leq \max(\min(1, \deg(v_7) + 1), \min(2, \deg(v_6) + 1), \min(3, \deg(v_1) + 1), \min(4, \deg(v_2) + 1), \min(5, \deg(v_8) + 1), \min(6, \deg(v_3) + 1), \min(7, \deg(v_4) + 1), \min(8, \deg(v_5) + 1)) = \max(1, 2, 3, 4, 4, 3, 3, 3) = 4$ .

The largest first approach is guided by the first principle, and so they use only one criterion to generate a sequence of vertices to be colored. However, this restriction can be lifted so that two or more criteria can be used at the same time. This is particularly important in breaking ties. In our example, if two vertices have the same degree, a vertex with the smaller index is chosen. In an algorithm proposed by Brélaz (1979), the primary criterion relies on the *saturation degree* of a vertex  $v$ , which is the number of different colors used to color neighbors of  $v$ . Should a tie occur, it is broken by choosing a vertex with the largest *uncolored degree*, which is the number of uncolored vertices adjacent to  $v$ .

```

BrelazColoringAlgorithm(graph)
  for each vertex v
    saturationDeg(v) = 0;
    uncoloredDeg(v) = deg(v);
  put colors in a certain order c1, c2, . . . , ck;
  while not all vertices are processed
    v = a vertex with highest saturation degree or,
        in case of a tie, vertex with maximum uncolored degree;
    j = the smallest index of color that does not appear in any neighbor of v;
    for each uncolored vertex u adjacent to v
      if no vertex adjacent to u is assigned color cj
        saturationDeg(u)++;
        uncoloredDeg(u)--;
    color(v) = cj;

```

For an example, see Figure 8.40d. First,  $v_7$  is chosen and assigned color  $c_1$  because  $v_7$  has the highest degree. Next, saturation degrees of vertices  $v_1, v_3, v_4, v_6$ , and  $v_8$  are set to one because they are vertices adjacent to  $v_7$ . From among these five vertices,  $v_6$  is selected because it has the largest number of uncolored neighbors. Then, saturation degrees of  $v_1$  and  $v_8$  are increased to two, and because both saturation and uncolored degrees of the two vertices are equal, we choose  $v_1$  as having a lower index. The remaining color assignments are shown in Figure 8.40d.

The `while` loop is executed  $|V|$  times;  $v$  is found in  $O(|V|)$  steps and the `for` loop takes  $deg(v)$  steps, which is also  $O(|V|)$ ; therefore, the algorithm runs in  $O(|V|^2)$  time.

## 8.12 NP-COMPLETE PROBLEMS IN GRAPH THEORY

In this section, NP-completeness of some problems in graph theory is presented.

### 8.12.1 The Clique Problem

A *clique* in a graph  $G$  is a complete subgraph of  $G$ . The clique problem is to determine whether  $G$  contains a clique  $K_m$  for some integer  $m$ . The problem is NP, because we can guess a set of  $m$  vertices and check in polynomial time whether a subgraph with these vertices is a clique. To show that the problem is NP-complete, we reduce the 3-satisfiability problem (see Section 2.10) to the clique problem. We perform reduction by showing that for a Boolean expression  $BE$  in CNF with three variables we can construct such a graph that the expression is satisfiable if there is a clique of size  $m$  in the graph. Let  $m$  be the number of alternatives in  $BE$ , that is,

$$BE = A_1 \wedge A_2 \wedge \dots \wedge A_m$$

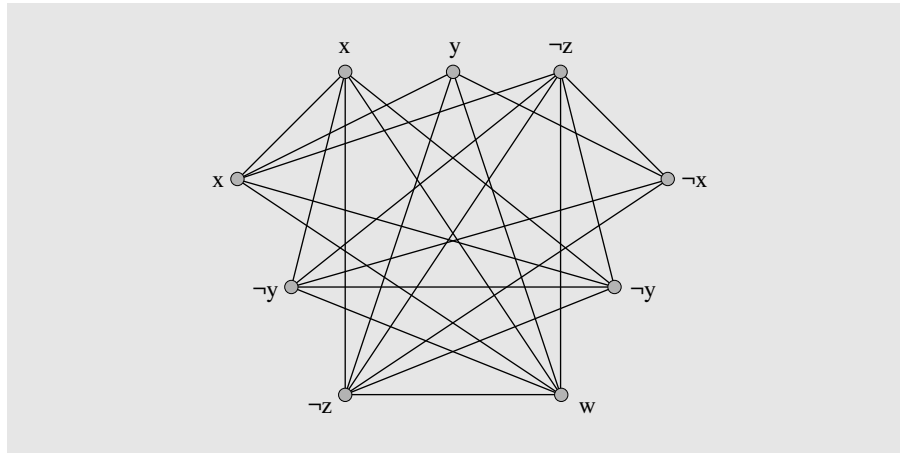
and each  $A_i = (p \vee q \vee r)$  for  $p \in \{x, \neg x\}$ ,  $q \in \{y, \neg y\}$ , and  $r \in \{z, \neg z\}$ , where  $x, y$ , and  $z$  are Boolean variables.

We construct a graph whose vertices represent all the variables and their negations found in  $BE$ . Two vertices are joined by an edge if variables they represent are in different alternatives and the variables are not complementary—that is, one is not a negation of the other. For example, for the expression

$$BE = (x \vee y \vee \neg z) \wedge (x \vee \neg y \vee \neg z) \wedge (w \vee \neg x \vee \neg y)$$

a corresponding graph is in Figure 8.41. With this construction, an edge between two vertices represents a possibility of both variables represented by the vertices to be true at the same time. An  $m$ -clique represents a possibility of one variable from each alternative to be true, which renders the entire  $BE$  true. In Figure 8.41, each triangle represents a 3-clique. In this way, if  $BE$  is satisfiable, then an  $m$ -clique can be found. It is also clear that if an  $m$ -clique exists, then  $BE$  is satisfiable. This shows that the satisfiability problem is reduced to the clique problem, and the latter is NP-complete because the former has already been shown to be NP-complete.

**FIGURE 8.41** A graph corresponding to the Boolean expression  $(x \vee y \vee \neg z) \wedge (x \vee \neg y \vee \neg z) \wedge (w \vee \neg x \vee \neg y)$ .



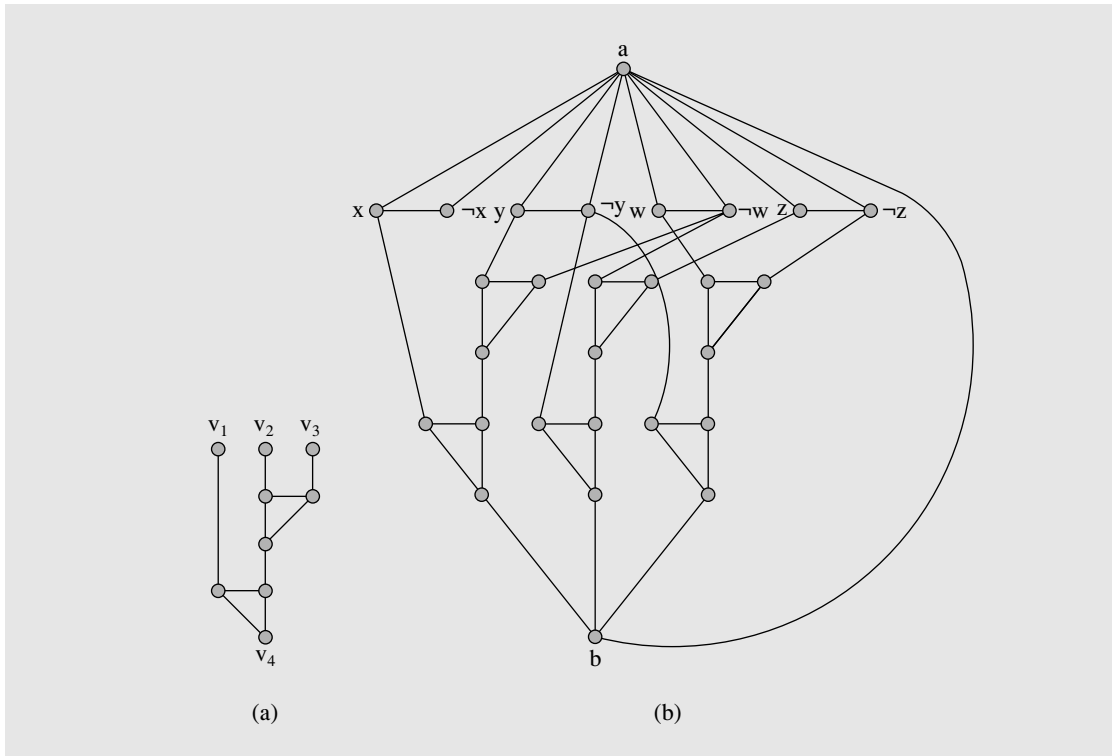
### 8.12.2 The 3-Colorability Problem

The 3-colorability problem is a question of whether a graph can be properly colored with three colors. We prove that the problem is NP-complete by reducing to it the 3-satisfiability problem. The 3-colorability problem is NP because we can guess a coloring of vertices with three colors and check in quadratic time that the coloring is correct (for each of the  $|V|$  vertices check the color of up to  $|V| - 1$  of its neighbors). To reduce the 3-satisfiability problem to the 3-colorability problem, we utilize an auxiliary 9-subgraph. A 9-subgraph takes 3 vertices,  $v_1$ ,  $v_2$ , and  $v_3$ , from an existing graph and adds 6 new vertices and 10 edges, as in Figure 8.42a. Consider the set  $\{f, t, n\}$  (fuchsia/false, turquoise/true, nasturtium/neutral) of three colors used to color a graph. The reader can easily check the validity of the following lemma.

**Lemma.** 1) If all three vertices,  $v_1$ ,  $v_2$ , and  $v_3$ , of a 9-subgraph are colored with  $f$ , then vertex  $v_4$  must also be colored with  $f$  to have the 9-subgraph colored correctly. 2) If only colors  $t$  and  $f$  can be used to color vertices  $v_1$ ,  $v_2$ , and  $v_3$  of a 9-subgraph and at least one is colored with  $t$ , then vertex  $v_4$  can be colored with  $t$ .  $\square$



**FIGURE 8.42** (a) A 9-subgraph; (b) a graph corresponding to the Boolean expression  $(\neg w \vee x \vee y) \wedge (\neg w \vee \neg y \vee z) \wedge (w \vee \neg y \vee \neg z)$ .



Now, for a given Boolean expression  $BE$  consisting of  $k$  alternatives we construct a graph in the following fashion. The graph has two special vertices,  $a$  and  $b$ , and  $edge(ab)$ . Moreover, the graph includes one vertex for each variable used in  $BE$  and the negation of this variable. For each pair of vertices  $x$  and  $\neg x$ , the graph includes  $edge(ax)$ ,  $edge(a(\neg x))$ , and  $edge(x(\neg x))$ . Next, for each alternative  $p, q,$  or  $r$  included in  $BE$ , the graph has a 9-subgraph whose vertices  $v_1, v_2,$  and  $v_3$  correspond to the three Boolean variables or their negations  $p, q,$  and  $r$  in this alternative. Finally, for each 9-subgraph, the graph includes  $edge(v_4 b)$ . A graph corresponding to the Boolean expression

$$(\neg w \vee x \vee y) \wedge (\neg w \vee \neg y \vee z) \wedge (w \vee \neg y \vee \neg z)$$

is presented in Figure 8.42b.

We now claim that if a Boolean expression  $BE$  is satisfiable, then the graph corresponding to it is 3-colorable. For each variable  $x$  in  $BE$ , we set  $color(x) = t$  and  $color(\neg x) = f$  when  $x$  is true, and  $color(x) = f$  and  $color(\neg x) = t$  otherwise. A Boolean expression is satisfiable if each alternative  $A_i$  in  $BE$  is satisfiable, which takes place when at least one variable  $x$  or its negation  $\neg x$  in  $A_i$  is true. Because, except for  $b$  (whose color is about to be determined), each neighbor of  $a$  has color  $t$  or  $f$ , and

because at least one of the three vertices  $v_1$ ,  $v_2$ , and  $v_3$  of each 9-subgraph has color  $t$ , each 9-subgraph is 3-colorable, and  $color(v_4) = t$ ; by setting  $color(a) = n$  and  $color(b) = f$ , the entire graph is 3-colorable.

Suppose that a graph as in Figure 8.42b is 3-colorable and that  $color(a) = n$  and  $color(b) = f$ . Because  $color(a) = n$ , each neighbor of  $a$  has color  $f$  or  $t$ , which can be interpreted so that the Boolean variable or its negation corresponding to this neighboring vertex is either true or false. Only if all three vertices,  $v_1$ ,  $v_2$ , and  $v_3$ , of any 9-subgraph have color  $f$  can vertex  $v_4$  have color  $f$ , but this would conflict with color  $f$  of vertex  $b$ . Therefore, no 9-subgraph's vertices  $v_1$ ,  $v_2$ , and  $v_3$  can all have color  $f$ ; that is, at least one of these vertices must have color  $t$  (the remaining one(s) having color  $f$ , not  $n$ , because  $color(a) = n$ ). This means that no alternative corresponding to a 9-subgraph can be false, which means each alternative is true, and so the entire Boolean expression is satisfiable.

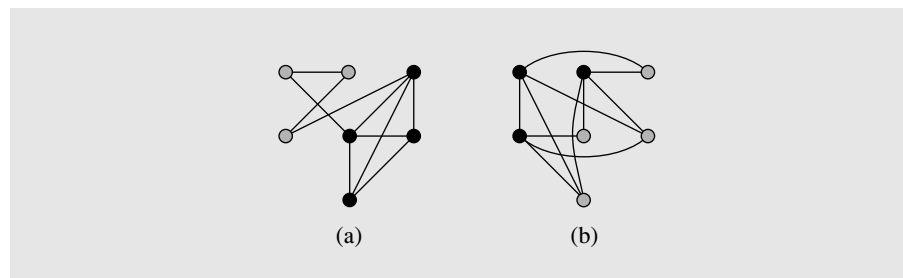
### 8.12.3 The Vertex Cover Problem

A *vertex cover* of an undirected graph  $G = (V, E)$  is a set of vertices  $W \subseteq V$  such that each edge in the graph is incident to at least one vertex from  $W$ . In this way, the vertices in  $W$  cover all the edges in  $E$ . The problem to determine whether  $G$  has a vertex cover containing at most  $k$  vertices for some integer  $k$  is NP-complete.

The problem is NP because a solution can be guessed and then checked in polynomial time. That the problem is NP-complete is shown by reducing the clique problem to the vertex cover problem.

First, define a *complement graph*  $\bar{G}$  of graph  $G = (V, E)$  to be a graph that has the same vertices  $V$ , but has connections between vertices that are not in  $G$ ; that is,  $\bar{G} = (V, \bar{E} = \{edge(uv): u, v \in V \text{ and } edge(uv) \notin E\})$ . The reduction algorithm converts in polynomial time a graph  $G$  with a  $(|V| - k)$ -clique into a complement graph  $\bar{G}$  with a vertex cover of size  $k$ . If  $C = (V_C, E_C)$  is a clique in  $G$ , then vertices from the set  $V - V_C$  cover all the edges in  $\bar{G}$ , because  $\bar{G}$  has no edges with both endpoints in  $V_C$ . Consequently,  $V - V_C$  is a vertex cover in  $\bar{G}$  (see Figure 8.43a for a graph with a clique and 8.43b for a complement graph with a vertex cover). Suppose now that  $\bar{G}$  has a vertex cover  $W$ ; that is, an edge is in  $\bar{E}$  if at least one endpoint of the edge is in  $W$ . Now, if none of the endpoints of an edge is in  $W$ , the edge is in graph  $G$ —the latter endpoints are in

**FIGURE 8.43** (a) A graph with a clique; (b) a complement graph.



$V - W$ , and thus  $V_C = V - W$  generates a clique. This proves that the positive answer to the clique problem is, through conversion, a positive answer to a vertex cover problem, and thus the latter is an NP-complete problem because the former is.

### 8.12.4 The Hamiltonian Cycle Problem

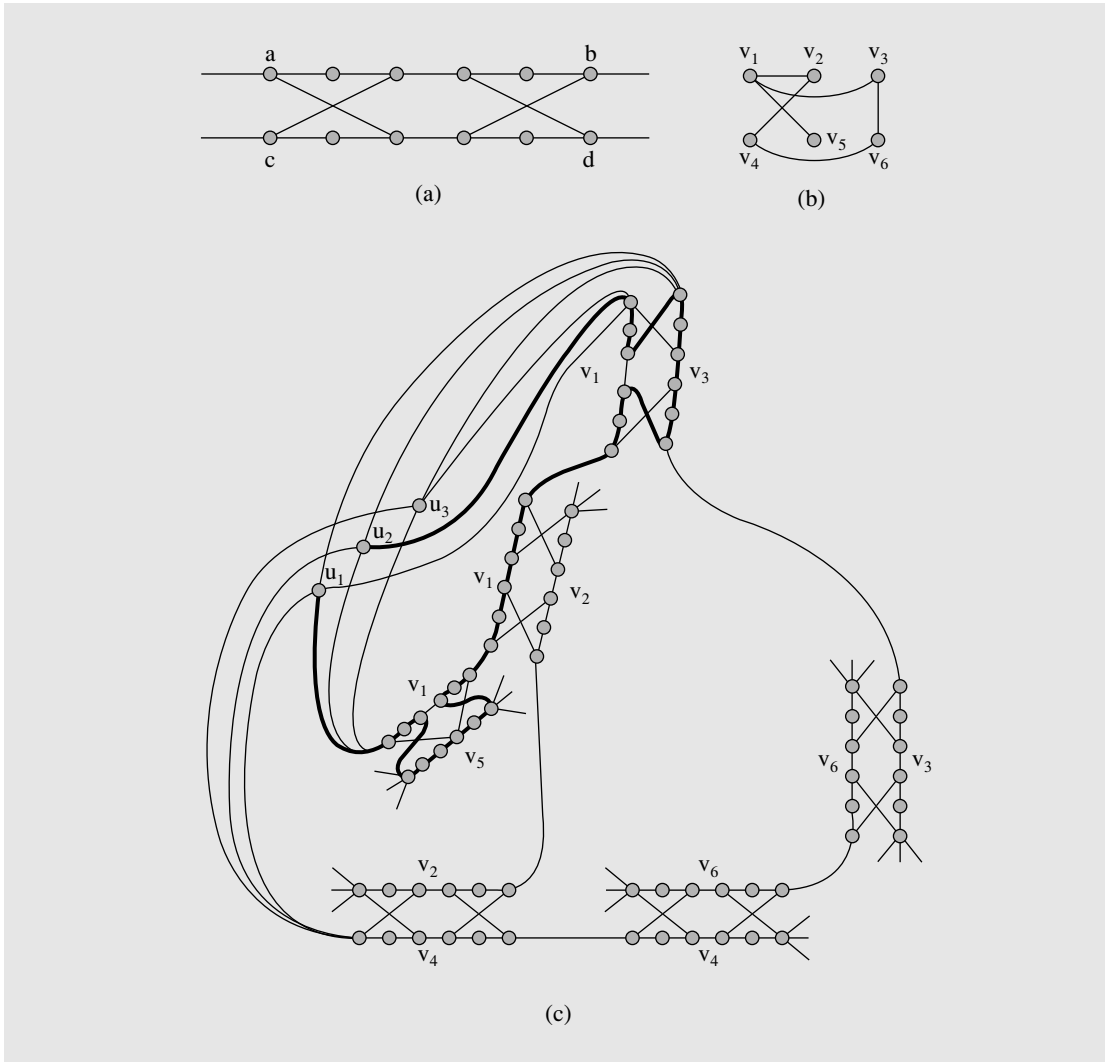
The contention that finding a Hamiltonian cycle in a simple graph  $G$  is an NP-complete problem is shown by reducing the vertex cover problem to the Hamiltonian cycle problem. First, we introduce an auxiliary concept of a 12-subgraph that is depicted in Figure 8.44a. The reduction algorithm converts each  $edge(vu)$  of graph  $G$  into a 12-subgraph so that one side of the subgraph, with vertices  $a$  and  $b$ , corresponds to a vertex  $v$  of  $G$ , and the other side, with vertices  $c$  and  $d$ , corresponds to vertex  $u$ . After entering one side of a 12-subgraph, for instance, at  $a$ , we can go through all the 12 vertices in order  $a, c, d, b$  and exit the 12-subgraph on the same side, at  $b$ . Also, we can go directly from  $a$  to  $b$  and if there is a Hamiltonian cycle in the entire graph, the vertices  $c$  and  $d$  are traversed during another visit of the 12-subgraph. Note that any other path through the 12-subgraph renders building a Hamiltonian cycle of the entire graph impossible.

Provided that we have a graph  $G$ , we build a graph  $G_H$  as follows. Create vertices  $u_1, \dots, u_k$  where  $k$  is the parameter corresponding to the vertex cover problem for graph  $G$ . Then, for each edge of  $G$ , a 12-subgraph is created; the 12-subgraphs associated with vertex  $v$  are connected together on the sides corresponding to  $v$ . Each endpoint of such a string of 12-subgraphs is connected to vertices  $u_1, \dots, u_k$ . The result of transforming graph  $G$  for  $k = 3$  in Figure 8.44b is the graph  $G_H$  in Figure 8.44c. To avoid clutter, the figure shows only some complete connections between endpoints of strings of 12-subgraphs and vertices  $u_1, u_2$ , and  $u_3$ , indicating only the existence of remaining connections. The claim is that there is a vertex cover of size  $k$  in graph  $G$  if there is a Hamiltonian cycle in graph  $G_H$ . Assume that  $W = \{v_1, \dots, v_k\}$  is a vertex cover in  $G$ . Then there is a Hamiltonian cycle in  $G_H$  formed in the following way. Beginning with  $u_1$ , go through the sides of 12-subgraphs that correspond to  $v_1$ . For a particular 12-subgraph, go through all of its 12 vertices if the other side of the 12-subgraph corresponds to a vertex in the cover  $W$ ; otherwise, go straight through the 12-subgraph. In the latter case, six vertices corresponding to a vertex  $w$  are not currently traversed, but they are traversed when processing the part of the Hamiltonian cycle corresponding to  $w$ . After the end of the string of 12-subgraphs is reached, go to  $u_2$ , and from here process the string of 12-subgraphs corresponding to  $v_2$ , and so on. For the last vertex  $u_k$ , process  $v_k$  and end the path at  $u_1$ , thereby creating a Hamiltonian cycle. Figure 8.44c presents with a thick line the part of the Hamiltonian cycle corresponding to  $v_1$  that begins at  $u_1$  and ends at  $u_2$ . Because the cover  $W = \{v_1, v_2, v_6\}$ , the processing continues for  $v_2$  at  $u_2$  and ends at  $u_3$ , and then for  $v_6$  at  $u_3$  and ends at  $u_1$ .

Conversely, if  $G_H$  has a Hamiltonian cycle, it includes subpaths through  $k$  12-subgraph strings that correspond to  $k$  vertices in  $G_C$  that form a cover.

Consider now this version of the traveling salesman problem. In a graph with distances assigned to each edge we try to determine whether there is a cycle with total distance with the combined distance not greater than an integer  $k$ . That the problem is NP-complete can be straightforwardly shown by reducing it to the Hamiltonian path problem.

**FIGURE 8.44** (a) A 12-subgraph; (b) a graph  $G$  and (c) its transformation, graph  $G_H$ .



### 8.13 CASE STUDY: DISTINCT REPRESENTATIVES

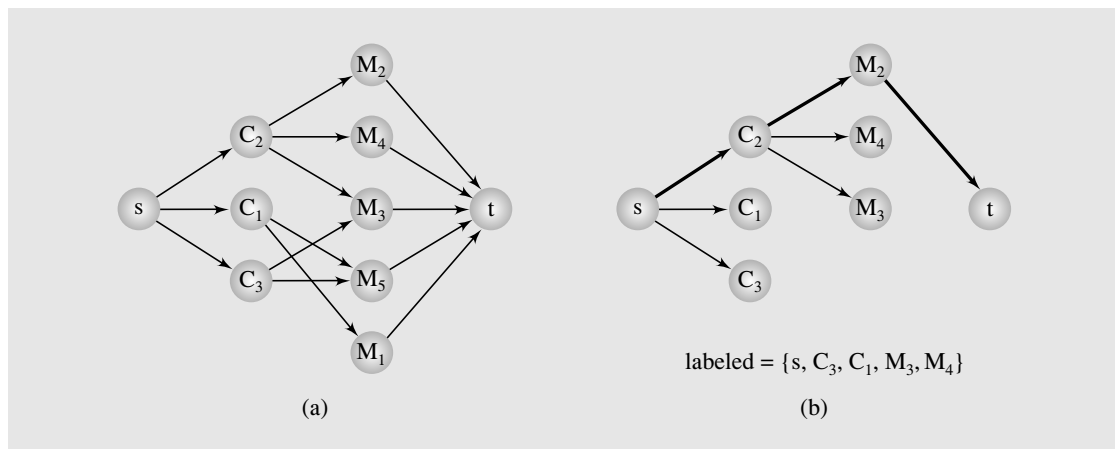
Let there be a set of committees,  $C = \{C_1, \dots, C_n\}$ , each committee having at least one person. The problem is to determine, if possible, representatives from each committee so that the committee is represented by one person and each person can represent only one committee. For example, if there are three committees,  $C_1 = \{M_5, M_1\}$ ,  $C_2 = \{M_2, M_4, M_3\}$ , and  $C_3 = \{M_3, M_5\}$ , then one possible representation is: member  $M_1$  represents committee  $C_1$ ,  $M_2$  represents  $C_2$ , and  $M_5$  represents  $C_3$ . However, if we have these three committees,  $C_4 = C_5 = \{M_6, M_7\}$ , and  $C_6 = \{M_7\}$ , then no distinct represen-

tation can be created, because there are only two members in all three committees combined. The latter observation has been proven by P. Hall in the *system of distinct representatives* theorem, which can be phrased in the following way:

**Theorem.** A nonempty collection of finite nonempty sets  $C_1, \dots, C_n$  has a system of distinct representatives if for any  $i \leq n$ , the union  $C_{k_1} \cup \dots \cup C_{k_i}$  has at least  $i$  elements.

The problem can be solved by creating a network and trying to find a maximum flow in this network. For example, the network in Figure 8.45a can represent the membership of the three committees,  $C_1$ ,  $C_2$ , and  $C_3$ . There is a dummy source vertex connected to nodes representing committees, the committee vertices are connected to vertices representing their members, and the member vertices are all connected to a dummy sink vertex. We assume that each edge  $e$ 's capacity  $cap(e) = 1$ . A system of distinct representatives is found if the maximum flow in the network equals the number of committees. The paths determined by a particular maximum flow algorithm determine the representatives. For example, member  $M_1$  would represent the committee  $C_1$  if a path  $s, C_1, M_1, t$  is determined.

**FIGURE 8.45** (a) A network representing membership of three committees,  $C_1$ ,  $C_2$ , and  $C_3$ , and (b) the first augmenting path found in this network.



The implementation has two main stages. First, a network is created using a set of committees and members stored in a file. Then, the network is processed to find augmenting paths corresponding to members representing committees. The first stage is specific to the system of distinct representatives. The second stage can be used for finding the maximum flow of any network because it assumes that the network has been created before it begins.

When reading committees and members from a file, we assume that the name of a committee is always followed by a colon and then by a list of members separated by commas and ended with a semicolon. An example is the following file `committees`, which includes information corresponding to the network in Figure 8.45a:

```

C2: M2, M4, M3;
C1: M5, M1;
C3: M3, M5;

```

The network is represented by the array list `vertices` storing objects of type `Vertex`. Each vertex `i` includes information necessary for proper processing of the vertex `i`: the name of the vertex, vertex slack, labeled/nonlabeled flag, adjacency list, parent in the current augmenting path, and a reference to a node `i` in the parent's adjacency list.

An adjacency list of a vertex in position `i` represents edges incident with this vertex. Each node on the list is identified by its `idNum`, which is the position in `vertices` of the same vertex. Information in each node of such a list also includes capacity of the edge, its flow, forward/backward flag, and a reference to the twin. If there is an edge from vertex `i` to `j`, then `i`'s adjacency list includes a node representing a forward edge from `i` to `j`, and `j`'s adjacency list has a node corresponding to a backward edge from `j` to `i`. Hence, each edge is represented twice in the network. If a path is augmented, then augmenting an edge means updating two nodes on two adjacency lists. To make it possible, each node on such a list points to its twin, or rather a node representing the same edge taken in the opposite direction.

In the first phase of the process, the method `readCommittees()` builds both the array list `vertices` and the adjacency list for each vertex in the array list when reading the data from the file `committees`. Both the array list and the lists include unique elements. The method also builds a separate adjacency list for the source vertex.

In the second phase, the program looks for augmenting paths. In the algorithm used here, the source node is always processed first because it is always pushed first onto stack `labeledS`. Because the algorithm requires processing only unlabeled vertices, there is no need to include the source vertex in any adjacency list, because the edge from any vertex to the source has no chance to be included in any augmenting path. In addition, after the sink is reached, the process of finding an augmenting path is discontinued, whereby no edge incident with the sink is processed, so there is no need to keep an adjacency list for the sink.

The structure created by `readCommittees()` using the file `committees` is shown in Figure 8.46; this structure represents the network shown in Figure 8.45a. The numbers in the nodes and array list elements are put by `FordFulkersonMaxFlow()` right after finding the first augmenting path, 0, 2, 3, 1; that is, the path *source*,  $C_2$ ,  $M_2$ , *sink* (Figure 8.45b). Nodes in the adjacency list of a vertex `i` do not include the names of vertices accessible from `i`, only their `idNum`; therefore, these names are shown above each node. The dashed lines show twin edges. In order not to clutter Figure 8.46 with too many links, only the links for two pairs of twin nodes are shown.

The output generated by the program

```

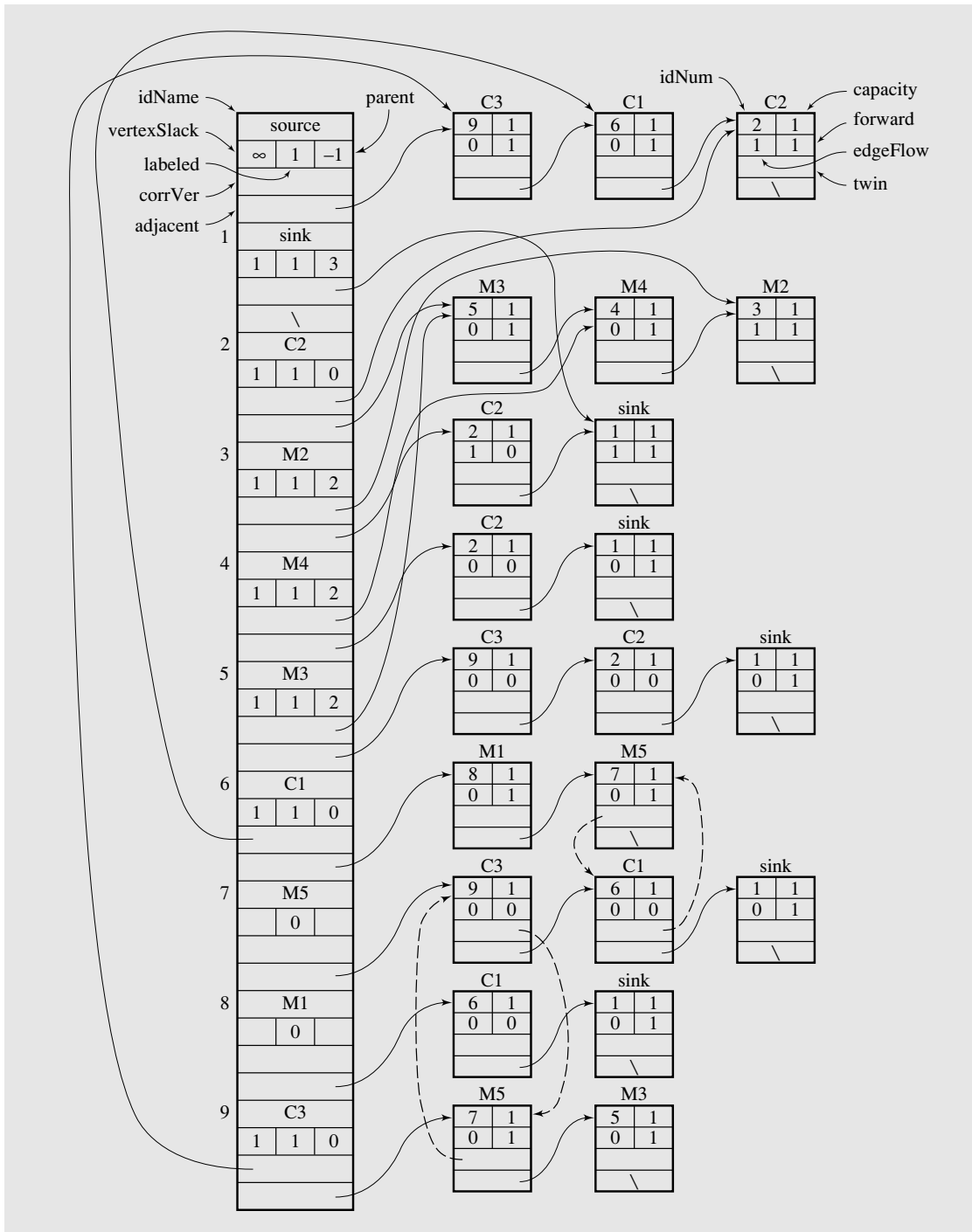
Augmenting paths:
source => C2 => M2 => sink (augmented by 1);
source => C1 => M5 => sink (augmented by 1);
source => C3 => M3 => sink (augmented by 1);

```

determines the following representation: Member  $M_2$  represents committee  $C_2$ ,  $M_5$  represents  $C_1$ , and  $M_3$  represents  $C_3$ .

Figure 8.47 contains the code for this program.

**FIGURE 8.46** The network representation created by `FordFulkersonMaxFlow()`.



**FIGURE 8.47** An implementation of the distinct representatives problem.

```

import java.io.*;
import java.util.*;

class Vertex {
    public int idNum, capacity, edgeFlow;
    public boolean forward; // direction;
    public Vertex twin; // edge in opposite direction;
    public Vertex() {
    }
    public Vertex(int id, int c, int ef, boolean f) {
        idNum = id; capacity = c; edgeFlow = ef; forward = f; twin = null;
    }
    public boolean equals(Object v) {
        return idNum == ((Vertex)v).idNum;
    }
    public String toString() {
        return (idNum + " " + capacity + " " + edgeFlow + " " + forward);
    }
}

class VertexInArray {
    public String idName;
    public int vertexSlack;
    public boolean labeled = false;
    public int parent;
    public LinkedList adjacent = new LinkedList();
    public Vertex corrVer; // corresponding vertex: vertex on parent's
    public VertexInArray() { // list of adjacent vertices with the same
    } // idNum as the cell's index;
    public VertexInArray(String s) {
        idName = s;
    }
    public boolean equals(Object v) {
        return idName.equals(((VertexInArray)v).idName);
    }
    public void display() {
        System.out.print(idName + ' ' + vertexSlack + ' '
            + labeled + ' ' + parent + ' ' + corrVer + "-> ");
        System.out.print(adjacent);
        System.out.println();
    }
}

```



**FIGURE 8.47** (continued)

```

class Network {
    public Network() {
        vertices.add(source,new VertexInArray());
        vertices.add(sink,new VertexInArray());
        ((VertexInArray)vertices.get(source)).idName = "source";
        ((VertexInArray)vertices.get(sink)).idName = "sink";
        ((VertexInArray)vertices.get(source)).parent = none;
    }
    private final int sink = 1, source = 0, none = -1;
    private ArrayList vertices = new ArrayList();
    private int edgeSlack(Vertex u) {
        return u.capacity - u.edgeFlow;
    }
    private boolean labeled(Vertex p) {
        return ((VertexInArray)vertices.get(p.idNum)).labeled;
    }
    public void display() {
        for (int i = 0; i < vertices.size(); i++) {
            System.out.print(i + ": ");
            ((VertexInArray)vertices.get(i)).display();
        }
    }

    public void readCommittees(String fileName, InputStream fIn) {
        int ch = 1, pos;
        try {
            while (ch > -1) {
                while (true)
                    if (ch > -1 && !Character.isLetter((char)ch)) // skip
                        ch = fIn.read(); // nonletters;
                    else break;
                if (ch == -1)
                    break;
                String s = "";
                while (ch > -1 && ch != ':') {
                    s += (char)ch;
                    ch = fIn.read();
                }
                VertexInArray committee = new VertexInArray(s.trim());
                int commPos = vertices.size();
                Vertex commVer = new Vertex(commPos,1,0,false);
            }
        }
    }
}

```

*Continues*

**FIGURE 8.47** (continued)

```

vertices.add(committee);
for (boolean lastMember = false; !lastMember; ) {
    while (true)
        if (ch > -1 && !Character.isLetter((char)ch))
            ch = fIn.read();          // skip nonletters;
        else break;
    if (ch == -1)
        break;
    s = "";
    while (ch > -1 && ch != ',' && ch != ';') {
        s += (char)ch;
        ch = fIn.read();
    }
    if (ch == ';')
        lastMember = true;
    VertexInArray member = new VertexInArray(s.trim());
    Vertex memberVer = new Vertex(0,1,0,true);
    if ((pos = vertices.indexOf(member)) == -1) {
        memberVer.idNum = vertices.size();
        member.adjacent.addFirst(new
            Vertex(sink,1,0,true));
        member.adjacent.addFirst(commVer);
        vertices.add(member);
    }
    else {
        memberVer.idNum = pos;
        ((VertexInArray)vertices.get(pos)).
            adjacent.addFirst(commVer);
    }
    committee.adjacent.addFirst(memberVer);
    memberVer.twin = commVer;
    commVer.twin = memberVer;
}
commVer = new Vertex(commPos,1,0,true);
((VertexInArray)vertices.get(source)).adjacent.
    addFirst(commVer);
}
} catch (IOException io) {
}
display();
}
private void label(Vertex u, int v) {

```

**FIGURE 8.47** (continued)

```

VertexInArray uu = (VertexInArray) vertices.get(u.idNum);
VertexInArray vv = (VertexInArray) vertices.get(v);
uu.labeled = true;
if (u.forward)
    uu.vertexSlack = Math.min(vv.vertexSlack, edgeSlack(u));
else uu.vertexSlack = Math.min(vv.vertexSlack, u.edgeFlow);
uu.parent = v;
uu.corrVer = u;
}
private void augmentPath() {
    int sinkSlack = ((VertexInArray)vertices.get(sink)).vertexSlack;
    Stack path = new Stack();
    for (int i = sink; i != source;
        i = ((VertexInArray)vertices.get(i)).parent) {
        VertexInArray vv = (VertexInArray) vertices.get(i);
        path.push(vv.idName);
        if (vv.corrVer.forward)
            vv.corrVer.edgeFlow += sinkSlack;
        else vv.corrVer.edgeFlow -= sinkSlack;
        if (vv.parent != source && i != sink)
            vv.corrVer.twin.edgeFlow = vv.corrVer.edgeFlow;
    }
    for (int i = 0; i < vertices.size(); i++)
        ((VertexInArray)vertices.get(i)).labeled = false;
    System.out.print(" source");
    while (!path.isEmpty())
        System.out.print(" => " + path.pop());
    System.out.print(" (augmented by " + sinkSlack + ");\n");
}
public void FordFulkersonMaxFlow() {
    Stack labeledS = new Stack();
    for (int i = 0; i < vertices.size(); i++)
        ((VertexInArray) vertices.get(i)).labeled = false;
    ((VertexInArray)vertices.get(source)).vertexSlack =
        Integer.MAX_VALUE;
    labeledS.push(new Integer(source));
    System.out.println("Augmenting paths:");
    while (!labeledS.isEmpty()) { // while not stuck;
        int v = ((Integer) labeledS.pop()).intValue();
        for (Iterator it = ((VertexInArray)vertices.get(v)).
            adjacent.iterator();

```

*Continues*

**FIGURE 8.47** (continued)

```

        it.hasNext(); ) {
Vertex u = (Vertex) it.next();
if (!labeled(u)) {
    if (u.forward && edgeSlack(u) > 0 ||
        !u.forward && u.edgeFlow > 0)
        label(u,v);
    if (labeled(u))
        if (u.idNum == sink) {
            augmentPath();
            labeledS.clear(); // look for another path;
            labeledS.push(new Integer(source));
            break;
        }
        else {
            labeledS.push(new Integer(u.idNum));
            ((VertexInArray)vertices.get(u.idNum)).
                labeled = true;
        }
    }
}
}
}

public class DistinctRepresentatives {
    static public void main(String args[]) {
        String fileName = "";
        Network net = new Network();
        InputStream fIn;
        InputStreamReader isr = new InputStreamReader(System.in);
        BufferedReader buffer = new BufferedReader(isr);
        try {
            if (args.length == 0) {
                System.out.print("Enter a file name: ");
                fileName = buffer.readLine();
                fIn = new FileInputStream(fileName);
            }
            else {
                fIn = new FileInputStream(args[0]);
                fileName = args[0];
            }
            net.readCommittees(fileName, fIn);
        }
    }
}

```

**FIGURE 8.47** *(continued)*

```
        fIn.close();
    } catch(IOException io) {
        System.err.println("Cannot open " + fileName);
    }
    net.FordFulkersonMaxFlow();
    net.display();
}
}
```

## 8.14

## EXERCISES

1. Look carefully at the definition of a graph. In one respect, graphs are more specific than trees. What is it?
2. What is the relationship between the sum of the degrees of all vertices and the number of edges of graph  $G = (V, E)$ ?
3. What is the complexity of `breadthFirstSearch()`?
4. Show that a simple graph is connected if it has a spanning tree.
5. Show that a tree with  $n$  vertices has  $n - 1$  edges.
6. How can `DijkstraAlgorithm()` be applied to undirected graphs?
7. How can `DijkstraAlgorithm()` be modified to become an algorithm for finding the shortest path from vertex  $a$  to  $b$ ?
8. The last clause from `genericShortestPathAlgorithm()`  
*add u to toBeChecked if it is not there;*  
 is not included in `DijkstraAlgorithm()`. Can this omission cause any trouble?
9. Modify `FordAlgorithm()` so that it does not fall into an infinite loop if applied to a graph with negative cycles.
10. For what digraph does the `while` loop of `FordAlgorithm()` iterate only one time? Two times?
11. Can `FordAlgorithm()` be applied to undirected graphs?
12. Make necessary changes in `FordAlgorithm()` to adapt it to solving the all-to-one shortest path problem and apply the new algorithm to vertex  $f$  in the graph in Figure 8.8. Using the same order of edges, produce a table similar to the table shown in this figure.
13. The D'Esopo-Pape algorithm is exponential in the worst case. Consider the following method to construct pathological graphs of  $n$  vertices (Kershenbaum 1981), each vertex identified by a number  $1, \dots, n$ :

```

KershenbaumAlgorithm()
  construct a two-vertex graph with vertices 1 and 2, and edge(1,2) = 1;
  for k = 3 to n
    add vertex k;
    for i = 2 to k - 1
      add edge(k,i) with weight(edge(k,i)) = weight(edge(1,i));
      weight(edge(1,i)) = weight(1,i) + 2k-3 + 1;
    add edge(1,k) with weight(edge(1,k)) = 1;

```

The vertices adjacent to vertex 1 are put in ascending order and the remaining adjacency lists are in descending order. Using this algorithm, construct a five-vertex graph and execute the D'Esopo-Pape algorithm showing all changes in the deque and all edge updates. What generalization can you make about applying Pape's method to such graphs?

14. What do you need to change in `genericShortestPathAlgorithm()` in order to convert it to Dijkstra's one-to-all algorithm?
15. Enhance `WFIAlgorithm()` to indicate the shortest paths, in addition to their lengths.
16. `WFIAlgorithm()` finishes execution gracefully even in the presence of a negative cycle. How do we know that the graph contains such a cycle?
17. The original implementation of `WFIAlgorithm()` given by Floyd is as follows:

```

WFIAlgorithm2(matrix weight)
  for i = 1 to |V|
    for j = 1 to |V|
      if weight[j,i] < ∞
        for k = 1 to |V|
          if weight[i,k] < ∞
            if (weight[j][k] > weight[j][i] + weight[i][k])
              weight[j][k] = weight[j][i] + weight[i][k];

```

Is there any advantage to this longer implementation?

18. One method of finding shortest paths from all vertices to all other vertices requires us to transform the graph so that it does not include negative weights. We may be tempted to do it by simply finding the smallest negative weight  $k$  and adding  $-k$  to the weights of all edges. Why is this method inapplicable?
19. For which edges does  $\leq$  in the inequality
 
$$dist(v) \leq dist(w) + weight(edge(wv))$$
 for any vertex  $w$  become  $<$ ?
20. Modify `cycleDetectionDFS()` so that it could determine whether a particular edge is part of a cycle in an undirected graph.
21. Our implementation of `union()` requires three arrays. Is it possible to use only two of them and still have the same information concerning roots, next vertices, and lengths? Consider using negative numbers.
22. When would `KruskalAlgorithm()` require  $|E|$  iterations?
23. How can the second minimum spanning tree be found?
24. Is the minimum spanning tree unique?
25. How can the algorithms for finding the minimum spanning tree be used to find the maximum spanning tree?
26. Apply the following two algorithms to find the minimum spanning tree to the graph in Figure 8.15a.
  - a. Probably the first algorithm for finding the minimum spanning tree was devised in 1926 by Otakar Borůvka (pronounced: boh-roof-ka). In this method, we start with  $|V|$  one-vertex trees, and for each vertex  $v$ , we look for an  $edge(vw)$  of minimum weight among all edges outgoing from  $v$  and create small trees by including

these edges. Then, we look for edges of minimal weight that can connect the resulting trees to larger trees. The process is finished when one tree is created. Here is a pseudocode for this algorithm:

```
BorůvkaAlgorithm(weighted connected undirected graph)
  make each vertex the root of a one-node tree;
  while there is more than one tree
    for each tree  $t$ 
       $e = \text{minimum weight edge}(v,u)$  where  $v$  is included in  $t$  and  $u$  is not;
      create a tree by combining  $t$  and the tree that includes  $u$ 
      if such a tree does not exist yet;
```

- b. Another algorithm was discovered by Vojtech Jarník (pronounced: yar-neek) in 1936 and later rediscovered by Robert Prim. In this method, all of the edges are also initially ordered, but a candidate for inclusion in the spanning tree is an edge that not only does not lead to cycles in the tree, but also is incident to a vertex already in the tree:

```
JarnikPrimAlgorithm(weighted connected undirected graph)
  tree = null;
  edges = sequence of all edges of graph sorted by weight;
  for i = 1 to  $|V| - 1$ 
    for j = 1 to |edges|
      if  $e_j$  from edges does not form a cycle with edges in tree and
      is incident to a vertex in tree
        add  $e_j$  to tree;
        break;
```

27. The algorithm `blockSearch()`, when used for undirected graphs, relies on the following observation: In a depth-first search tree created for an undirected graph, each back edge connects a successor to a predecessor (and not, for instance, a sibling to a sibling). Show the validity of this observation.
28. What is the complexity of `blockSearch()`?
29. Blocks in undirected graphs are defined in terms of edges, and the algorithm `blockDFS()` stores edges on the stack to output blocks. On the other hand, SCCs in digraphs are defined in terms of vertices, and the algorithm `strongDFS()` stores vertices on the stack to output SCC. Why?
30. Consider a possible implementation of `topologicalSort()` by using in it the following routine:

```
minimalVertex(digraph)
  v = a vertex of digraph;
  while v has a successor
    v = successor(v);
  return v;
```

What is the disadvantage of using this implementation?



31. A *tournament* is a digraph in which there is exactly one edge between every two vertices.
- How many edges does a tournament have?
  - How many different tournaments of  $n$  edges can be created?
  - Can each tournament be topologically sorted?
  - How many minimal vertices can a tournament have?
  - A *transitive tournament* is a tournament that has  $edge(vw)$  if it has  $edge(vu)$  and  $edge(uw)$ . Can such a tournament have a cycle?
32. Does considering loops and parallel edges complicate the analysis of networks? How about multiple sources and sinks?
33. `FordFulkersonAlgorithm()` assumes that it terminates. Do you think such an assumption is safe?
34. `FordFulkersonAlgorithm()` executed in a depth-first fashion has some redundancy. First, all outgoing edges are pushed onto the stack and then the last is popped off to be followed by the algorithm. For example, in the network in Figure 8.20a, first, all three edges coming out of vertex  $s$  are pushed, and only afterward is the last of them,  $edge(se)$ , followed. Modify `FordFulkersonAlgorithm()` so that the first edge coming out of a certain vertex is immediately followed, and the second is followed only if the first does not lead to the sink. Consider using recursion.
35. Find the capacity of the cut determined by the set  $X = \{s, d\}$  in the graph in Figure 8.19.
36. What is the complexity of `DinicAlgorithm()` in a network where all edges have a capacity of one?
37. Why does `DinicAlgorithm()` start from the sink to determine a layered network?
38. Apply to Figure 8.38a the following approximation algorithms (Johnson and Papadimitriou, 1985; Rosenkrantz et al., 1977) to solve the traveling salesman problem.
- The *nearest neighbor algorithm* (*next best method*) begins with an arbitrary vertex  $v$  and then finds a vertex  $w$  not on the tour that is closest to the vertex  $u$  last added and includes in the tour  $edge(uw)$  and  $edge(wv)$  after deleting  $edge(vw)$ .
  - The *nearest insertion algorithm* is obtained from `nearestAdditionAlgorithm()` by minimizing
 
$$edge(v_p v_i) + edge(v_i v_q) - edge(v_p v_q)$$
 In this way, a new vertex  $v_i$  is inserted in the best place in the existing tour, which may not be next to  $v_p$ .
  - The *cheapest insertion algorithm* is obtained from `nearestAdditionAlgorithm()` by including in `tour` a new vertex  $v_i$  that minimizes the length of the new tour.
  - The *farthest insertion algorithm* is just like the nearest insertion algorithms except that it requires that  $v_i$  is farthest from `tour`, not closest.

e. The *nearest merger algorithm*, which corresponds to the Borůvka algorithm:

```
nearestMergerAlgorithm(cities V)
  create |V| tours such that  $\text{tour}_i = \{\text{edge}(v_i v_i)\}$ ;
  while there are at least two tours
    find two closest tours  $\text{tour}_i$  and  $\text{tour}_j$ 
      (the minimum distance between city  $v_s \in \text{tour}_i$  and  $v_t \in \text{tour}_j$  is the smallest for all tours);
    find  $\text{edge}(v_k v_l) \in \text{tour}_i$  and  $\text{edge}(v_p v_q) \in \text{tour}_j$  such that they minimize
       $\text{dist}(\text{edge}(v_k v_l)) + \text{dist}(\text{edge}(v_p v_q)) - \text{dist}(\text{edge}(v_k v_l)) - \text{dist}(\text{edge}(v_p v_q))$ ;
     $\text{tour}_i = \text{tour}_i \cup \text{tour}_j \cup \{\text{edge}(v_k v_l), \text{edge}(v_p v_q)\} - \{\text{edge}(v_k v_l), \text{edge}(v_p v_q)\}$ ;
    remove  $\text{tour}_j$ ;
```

39. Consider a bipartite graph  $G = (\{u_1, u_2, \dots, u_k\} \cup \{w_1, w_2, \dots, w_k\}, \{\text{edge}(u_i w_j) : i \neq j\})$ . How many colors are needed to color vertices of  $G$  with `sequentialColoringAlgorithm()` if vertices are colored in this order
- $u_1, \dots, u_k, w_1, \dots, w_k$ ?
  - $u_1, w_1, u_2, w_2, \dots, u_k, w_k$ ?
40. What is the vertex cover for a matching? For a bipartite graph?
41. Show a coloring of the 9-subgraph from Figure 8.42a in which one vertex  $x, y,$  or  $z$  is  $t$ , the color of the other two vertices is  $f$ , and  $\text{color}(p) = f$ .
42. Show that the 2-colorability problem can be solved in polynomial time.
43. Show that the number of odd-degree vertices in simple graphs is even.
44. What would be the output of the program in the case study if linked lists in Figure 8.46 were in the reverse order?

## 8.15 PROGRAMMING ASSIGNMENTS

- All algorithms discussed in this chapter for determining the minimum spanning tree have one thing in common: They start building the tree from the beginning and they add new edges to the structure, which eventually becomes such a tree. However, we can go in the opposite direction and build this tree by successively removing edges to break cycles in the graph until no circuit is left. In this way, the graph turns into the tree. The edges chosen for removal should be the edges of maximum weight among those that can break any cycle in the tree (for example, Dijkstra's method). This algorithm somewhat resembles the Kruskal method, but because it works in the opposite direction, it can be called a Kruskal method *à rebours*. Use this approach to find the minimum spanning tree for the graph of distances between at least a dozen cities.
- Write a graphics demonstration program to show the difference between Kruskal's method and Jarník-Prim's algorithm. Randomly generate 50 vertices and display them in the left half of the screen. Then, randomly generate 200 edges and display them. Make sure that the graph is connected. After the graph is ready, create the minimum spanning tree using Kruskal's method and display each edge included in the

tree. (Use a different color than the one used during graph generation.) Then, display the same graph in the right half of the screen, create the minimum spanning tree using Jarnik-Prim's algorithm, and display all edges being included in the tree.

3. An important problem in database management is preventing deadlocks between transactions. A transaction is a sequence of operations on records in the database. In large databases, many transactions can be executed at the same time. This can lead to inconsistencies if the order of executing operations is not monitored. However, this monitoring may cause transactions to block each other, thereby causing a deadlock. To detect a deadlock, a wait-for graph is constructed to show which transaction waits for which. Use a binary locking mechanism to implement a wait-for graph. In this mechanism, if a record  $R$  is accessed by a transaction  $T_i$ , then  $T_i$  puts a lock on  $R$  and this record cannot be processed by any other transaction before  $T_i$  is finished. Release all locks put on by a transaction  $T$  when  $T$  finishes. The input is composed of the following commands:  $read(T,A)$ ,  $write(T,A)$ ,  $end(T)$ . For example, if input is

$$read(T_1,A_1), read(T_2,A_2), read(T_1,A_2), write(T_1,A_2), end(T_1) \dots$$

then  $T_1$  is suspended when attempting to execute the step  $read(T_1,A_2)$ , and  $edge(T_1,T_2)$  is created, because  $T_1$  waits for  $T_2$  to finish. If  $T_1$  does not have to wait, resume its execution. After each graph update, check for a cycle in the graph. If a cycle is detected, interrupt execution of the youngest transaction  $T$  and put its steps at the end of the input.

Note that some records might have been modified by such a transaction, so they should be restored to their state before  $T$  started. But such a modification could have been used by another transaction, which should also be interrupted. In this program, do not address the problem of restoring the values of records (the problem of rolling back transactions and of cascading this rolling back). Concentrate on updating and monitoring the wait-for graph. Note that if a transaction is finished, its vertex should be removed from the graph, which may be what other transactions are waiting for.

4. Write a rudimentary spreadsheet program. Display a grid of cells with columns A through H and rows 1 through 20. Accept input in the first row of the screen. The commands are of the form *column row entry*, where *entry* is either a number, a cell address preceded by a plus (e.g., +A5), a string, or a function preceded by an at sign, @. The functions are: *max*, *min*, *avg*, and *sum*. During execution of your program, build and modify the graph reflecting the situation in the spreadsheet. Show the proper values in proper cells. If a value in a cell is updated, then the values in all cells depending on it should also be modified. For example, after the following sequence of entries:

```
A1 10
B1 20
A2 30
D1 +A1
C1 @sum(A1..B2)
D1 +C1
```

both cells C1 and D1 should display the number 60.

Consider using a modification of the interpreter from Chapter 5 as an enhancement of this spreadsheet so that arithmetic expressions could also be used to enter values, such as

C3  $2 * A1$

C4  $\text{max}(A1..B2) - (A2 + B2)$

## BIBLIOGRAPHY

Ahuja, Ravindra K., Magnanti, Thomas L., and Orlin, James B., *Network Flows; Theory, Algorithms, and Applications*, Englewood Cliffs, NJ: Prentice Hall, 1993.

Berge, Claude, "Two Theorems in Graph Theory," *Proceedings of the National Academy of Sciences of the USA* 43 (1957), 842–844.

Bertsekas, Dimitri P., "A Simple and Fast Label Correcting Algorithm for Shortest Paths," *Networks* 23 (1993), 703–709.

Bondy, J. A. and Chvátal, V., "A Method in Graph Theory," *Discrete Mathematics* 15 (1976), 111–135.

Bondy, John A., and Murty, U. S. R., *Graph Theory with Applications*, New York: Elsevier, 1976.

Brélaž, Daniel, "New Methods to Color the Vertices of a Graph," *Communications of the ACM* 22 (1979), 251–256.

Chvátal, V., "Hamiltonian Cycles," in Lawler, E. L., Lenstra, J. K., Rinnoy, Kan, A. H. G., and Shmoys, D. B. (eds.), *The Traveling Salesman Problem*, New York: Wiley (1985), 403–429.

Deo, Narsingh, and Pang, Chi-yin, "Shortest Path Algorithms: Taxonomy and Annotation," *Networks* 14 (1984), 275–323.

Dijkstra, E. W., "A Note on Two Problems in Connection with Graphs," *Numerische Mathematik* 1 (1959), 269–271.

Dijkstra, E. W., "Some Theorems on Spanning Subtrees of a Graph," *Indagationes Mathematicae* 28 (1960), 196–199.

Dinic, Efim A., "Algorithm for Solution of a Problem of Maximum Flow in a Network with Power Estimation" [Mistranslation of: with Polynomial Bound], *Soviet Mathematics Doklady* 11 (1970), 1277–1280.

Edmonds, Jack, "Paths, Trees, and Flowers," *Canadian Journal of Mathematics* 17 (1963), 449–467.

Edmonds, Jack, "The Chinese Postman Problem," *Operations Research* 13 (1965), Suppl. 1, B–73.

Edmonds, Jack, and Johnson, Elias L., "Matching, Euler Tours and the Chinese Postman," *Mathematical Programming* 5 (1973), 88–124.

Edmonds, Jack, and Karp, Richard M., "Theoretical Improvement in Algorithmic Efficiency for Network Flow Problems," *Journal of the ACM* 19 (1972), 248–264.

Fleury, "Deux Problèmes de Géométrie de Situation," *Journal de Mathématiques Élémentaires* 1883, 257–261.

- Floyd, Robert W., "Algorithm 97: Shortest Path," *Communications of the ACM* 5 (1962), 345.
- Ford, Lester R., and Fulkerson, D. R., "Maximal Flow Through a Network," *Canadian Journal of Mathematics* 8 (1956), 399–404.
- Ford, Lester R., and Fulkerson, D. R., "A Simple Algorithm for Finding Maximal Network Flows and an Application to the Hitchcock Problem," *Canadian Journal of Mathematics* 9 (1957), 210–218.
- Ford, Lester R., and Fulkerson, D. R., *Flows in Networks*, Princeton, NJ: Princeton University Press, 1962.
- Gale, D., and Shapley, L. S., "College Admissions and the Stability of Marriage," *American Mathematical Monthly* 69 (1962), 9–15.
- Gallo, Giorgio, and Pallottino, Stefano, "Shortest Path Methods: A Unified Approach," *Mathematical Programming Study* 26 (1986), 38–64.
- Gallo, Giorgio, and Pallottino, Stefano, "Shortest Path Methods," *Annals of Operations Research* 7 (1988), 3–79.
- Gibbons, Alan, *Algorithmic Graph Theory*, New York: Cambridge University Press, 1985.
- Glover, Fred, Glover, Randy, and Klingman, Darwin, "Computational Study of an Improved Shortest Path Algorithm," *Networks* 14 (1984), 25–36.
- Gould, Ronald, *Graph Theory*, Menlo Park, CA: Benjamin Cummings, 1988.
- Graham, R. L., and Hell, Pavol, "On the History of the Minimum Spanning Tree Problem," *Annals of the History of Computing* 7 (1985), 43–57.
- Hall, Philip, "On Representatives of Subsets," *Journal of the London Mathematical Society* 10 (1935), 26–30.
- Ingerman, P. Z., "Algorithm 141: Path Matrix," *Communications of the ACM* 5 (1962), 556.
- Johnson, Donald B., "Efficient Algorithms for Shortest Paths in Sparse Networks," *Journal of the ACM* 24 (1977), 1–13.
- Johnson, D. S. and Papadimitriou, C. H., "Performance Guarantees for Heuristics," in Lawler, E. L., Lenstra, J. K., Rinnoy, Kan A. H. G., and Shmoys, D. B. (eds.), *The Traveling Salesman Problem*, New York: Wiley (1985), 145–180.
- Kalaba, Robert, "On Some Communication Network Problems," *Combinatorial Analysis*, Providence, RI: American Mathematical Society (1960), 261–280.
- Kershenbaum, Aaron, "A Note on Finding Shortest Path Trees," *Networks* 11 (1981), 399–400.
- Kruskal, Joseph B., "On the Shortest Spanning Tree of a Graph and the Traveling Salesman Problem," *Proceedings of the American Mathematical Society* 7 (1956), 48–50.
- Kuhn, Harold W., "The Hungarian Method for the Assignment Problem," *Naval Research Logistics Quarterly* 2 (1955), 83–97.
- Kwan, Mei-ko, "Graphic Programming Using Odd or Even Points," *Chinese Mathematics* 1 (1962), 273–277, translation of a paper published in *Acta Mathematica Sinica* 10 (1960), 263–266.
- Munkres, James, "Algorithms for the Assignment Problem and Transportation Problems," *Journal of the Society of Industrial and Applied Mathematics* 5 (1957), 32–38.

- Ore, Oystein, "Note on Hamilton Circuits," *American Mathematical Monthly* 67 (1960), 55.
- Papadimitriou, Christos H., and Steiglitz, Kenneth, *Combinatorial Optimization: Algorithms and Complexity*, Englewood Cliffs, NJ: Prentice Hall, 1982.
- Pape, U., "Implementation and Efficiency of Moore-Algorithms for the Shortest Route Problem," *Mathematical Programming* 7 (1974), 212–222.
- Pollack, Maurice, and Wiebenson, Walter, "Solutions of the Shortest-Route Problem—A Review," *Operations Research* 8 (1960), 224–230.
- Prim, Robert C., "Shortest Connection Networks and Some Generalizations," *Bell System Technical Journal* 36 (1957), 1389–1401.
- Rosenkrantz, Daniel J., Stearns, Richard E., and Lewis, Philip M., "An Analysis of Several Heuristics for the Traveling Salesman Problem," *SIAM Journal on Computing* 6 (1977), 563–581.
- Tarjan, Robert E., *Data Structures and Network Algorithms*, Philadelphia: Society for Industrial and Applied Mathematics, 1983.
- Thulasiraman, K., and Swamy, M. N. S., *Graphs: Theory and Algorithms*, New York: Wiley, 1992.
- Warshall, Stephen, "A Theorem on Boolean Matrices," *Journal of the ACM* 9 (1962), 11–12.
- Welsh, D. J. A., and Powell, M. B., "An Upper Bound for the Chromatic Number of a Graph and Its Application to Timetabling Problems," *Computer Journal* 10 (1967), 85–86.

# Sorting



The efficiency of data handling can often be substantially increased if the data are sorted according to some criteria of order. For example, it would be practically impossible to find a name in the telephone directory if the names were not alphabetically ordered. The same can be said about dictionaries, book indexes, payrolls, bank accounts, student lists, and other alphabetically organized materials. The convenience of using sorted data is unquestionable and must be addressed in computer science as well. Although a computer can grapple with an unordered telephone book more easily and quickly than a human can, it is extremely inefficient to have the computer process such an unordered data set. It is often necessary to sort data before processing.

The first step is to choose the criteria that will be used to order data. This choice will vary from application to application and must be defined by the user. Very often, the sorting criteria are natural, as in the case of numbers. A set of numbers can be sorted in ascending or descending order. The set of five positive integers (5, 8, 1, 2, 20) can be sorted in ascending order resulting in the set (1, 2, 5, 8, 20) or in descending order resulting in the set (20, 8, 5, 2, 1). Names in the phone book are ordered alphabetically by last name, which is the natural order. For alphabetic and nonalphabetic characters, the American Standard Code for Information Interchange (ASCII) code is commonly used, although other choices such as Extended Binary Coded Decimal Interchange Code (EBCDIC) are possible. Once a criterion is selected, the second step is how to put a set of data in order using that criterion.

The final ordering of data can be obtained in a variety of ways, and only some of them can be considered meaningful and efficient. To decide which method is best, certain criteria of efficiency have to be established and a method for quantitatively comparing different algorithms must be chosen.

To make the comparison machine-independent, certain critical properties of sorting algorithms should be defined when comparing alternative methods. Two such properties are the number of comparisons and the number of data movements. The choice of these two properties should not be surprising. To sort a set of data, the data have to be compared and moved as necessary; the efficiency of these two operations depends on the size of the data set.

Because determining the precise number of comparisons is not always necessary or possible, an approximate value can be computed. For this reason, the number of comparisons and movements is approximated with big-O notation by giving the order of magnitude of these numbers. But the order of magnitude can vary depending on the initial ordering of data. How much time, for example, does the machine spend on data ordering if the data are already ordered? Does it recognize this initial ordering immediately or is it completely unaware of that fact? Hence, the efficiency measure also indicates the “intelligence” of the algorithm. For this reason, the number of comparisons and movements is computed (if possible) for the following three cases: best case (often, data already in order), worst case (usually, data in reverse order), and average case (data in random order). Some sorting methods perform the same operations regardless of the initial ordering of data. It is easy to measure the performance of such algorithms, but the performance itself is usually not very good. Many other methods are more flexible, and their performance measures for all three cases differ.

The number of comparisons and the number of movements do not have to coincide. An algorithm can be very efficient on the former and perform poorly on the latter, or vice versa. Therefore, practical reasons must aid in the choice of which algorithm to use. For example, if only simple keys are compared, such as integers or characters, then the comparisons are relatively fast and inexpensive. If strings or arrays of numbers are compared, then the cost of comparisons goes up substantially, and the weight of the comparison measure becomes more important. If, on the other hand, the data items moved are large, such as structures, then the movement measure may stand out as the determining factor in efficiency considerations. All theoretically established measures have to be used with discretion, and theoretical considerations should be balanced with practical applications. After all, the practical applications serve as a rubber stamp for theory decisions.

Sorting algorithms, whose number can be counted in the dozens, are of different levels of complexity. A simple method can be only 20 percent less efficient than a more elaborate one. If sorting is used in the program once in a while and only for small sets of data, then using a sophisticated and slightly more efficient algorithm may not be desirable; the same operation can be performed using a simpler method and simpler code. But if thousands of items are to be sorted, then a gain of 20 percent must not be neglected. Simple algorithms often perform better with a small amount of data than their more complex counterparts whose effectiveness may become obvious only when data samples become very large.

## 9.1

## ELEMENTARY SORTING ALGORITHMS

### 9.1.1 Insertion Sort

An *insertion sort* starts by considering the two first elements of the array `data`, which are `data[0]` and `data[1]`. If they are out of order, an interchange takes place. Then, the third element, `data[2]`, is considered and inserted into its proper place. If `data[2]` is less than `data[0]` and `data[1]`, these two elements are shifted by one position; `data[0]` is placed at position 1, `data[1]` at position 2, and `data[2]` at position 0. If `data[2]` is less than `data[1]` and not less than `data[0]`, then only `data[1]` is moved to position 2 and its place is taken by `data[2]`. If, finally,



`data[2]` is not less than both its predecessors, it stays in its current position. Each element `data[i]` is inserted into its proper location `j` such that  $0 \leq j \leq i$ , and all elements greater than `data[i]` are moved by one position.

An outline of the insertion sort algorithm is as follows:

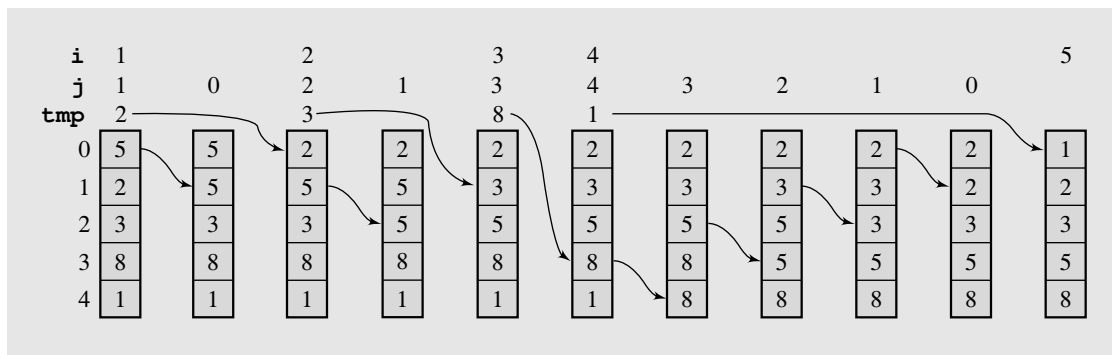
```
insertionsort(data[]) {
    for i = 1 to data.length-1
        tmp = data[i];
        move all elements data[j] greater than tmp by one position;
        place tmp in its proper position;
```

In this method, sorting is restricted only to a fraction of the array in each iteration, and only in the last pass is the whole array considered. Figure 9.1 shows what changes are made to the integer array [5 2 3 8 1] when `insertionsort()` executes. An array having only one element is already ordered, so the algorithm starts sorting from the second position, position 1. Then for each element `tmp = data[i]`, all elements greater than `tmp` are copied to the next position, and `tmp` is put in its proper place.

An implementation of insertion sort is

```
public void insertionsort(Object[] data) {
    for (int i = 1, j; i < data.length; i++) {
        Comparable tmp = (Comparable)data[i];
        for (j = i; j > 0 && tmp.compareTo(data[j-1]) < 0; j--)
            data[j] = data[j-1];
        data[j] = tmp;
    }
}
```

**FIGURE 9.1** The array [5 2 3 8 1] sorted by insertion sort.



This is a generic implementation, as are implementations of the sorting algorithms that follow. For arrays of the basic type, separate implementations are needed to avoid using wrapper classes. For example, for arrays of integers, the following implementation should be used:

```

public void insertionsort(int[] data) {
    for (int i = 1, j; i < data.length; i++) {
        int tmp = data[i];
        for (j = i, j; j > 0 && tmp < data[j-1]; j--)
            data[j] = data[j-1];
        data[j] = tmp;
    }
}

```

Another version is needed for characters, for float numbers, and so on. This chapter focuses on the mechanics of the algorithms; therefore, only one generic implementation is used. However, for each sorting algorithm (except for radix sort), the number of implementations should match the number of implementations provided by Java, as discussed in Section 9.4.

An advantage of using insertion sort is that it sorts the array only when it is really necessary. If the array is already in order, no substantial moves are performed; only the variable `tmp` is initialized, and the value stored in it is moved back to the same position. The algorithm recognizes that part of the array is already sorted and stops execution accordingly. But it recognizes only this, and the fact that elements may already be in their proper positions is overlooked. Therefore, they can be moved from these positions and then later moved back. This happens to numbers 2 and 3 in the example in Figure 9.1. Another disadvantage is that if an item is being inserted, all elements greater than the one being inserted have to be moved. Insertion is not localized and may require moving a significant number of elements. Considering that an element can be moved from its final position only to be placed there again later, the number of redundant moves can slow down execution substantially.

To find the number of movements and comparisons performed by `insertionsort()`, observe first that the outer `for` loop always performs  $n - 1$  iterations, where  $n = \text{data.length}$ . However, the number of elements greater than `data[i]` to be moved by one position is not always the same.

The best case is when the data are already in order. Only one comparison is made for each position  $i$ , so there are  $n - 1$  comparisons, which is  $O(n)$ , and  $2(n - 1)$  moves, all of them redundant.

The worst case is when the data are in reverse order. In this case, for each  $i$ , the item `data[i]` is less than every item `data[0], . . . , data[i-1]`, and each of them is moved by one position. For each iteration  $i$  of the outer `for` loop, there are  $i$  comparisons, and the total number of comparisons for all iterations of this loop is

$$\sum_{i=1}^{n-1} i = 1 + 2 + \cdots + (n - 1) = \frac{n(n - 1)}{2} = O(n^2)$$

The number of times the assignment in the inner `for` loop is executed can be computed using the same formula. The number of times `tmp` is loaded and unloaded in the outer `for` loop is added to that, resulting in the total number of moves:

$$\frac{n(n - 1)}{2} + 2(n - 1) = \frac{n^2 + 3n - 4}{2} = O(n^2)$$

Only extreme cases have been taken into consideration. What happens if the data are in random order? Is the sorting time closer to the time of the best case,  $O(n)$ , or to the worst case,  $O(n^2)$ ? Or is it somewhere in between? The answer is not immediately evident and requires certain introductory computations.

For every iteration  $i$  of the outer `for` loop, the number of comparisons depends on how far away the item `data[i]` is from its proper position in the currently sorted subarray `data[0 . . . i]`. If it is already in this position, only one test is performed that compares `data[i]` and `data[i-1]`. If it is one position away from its proper place, two comparisons are performed: `data[i]` is compared with `data[i-1]` and then with `data[i-2]`. Generally, if it is  $j$  positions away from its proper location, `data[i]` is compared with  $j + 1$  other elements. This means that, in iteration  $i$  of the outer `for` loop, there are either 1, 2, . . . , or  $i$  comparisons.

Under the assumption of equal probability of occupying array cells, the average number of comparisons of `data[i]` with other elements during the iteration  $i$  of the outer `for` loop can be computed by adding all the possible numbers of times such tests are performed and dividing the sum by the number of such possibilities. The result is

$$\frac{1+2+\dots+i-1}{i} = \frac{\frac{1}{2}i(i+1)}{i} = \frac{i+1}{2}$$

To obtain the average number of all comparisons, the computed figure has to be added for all  $i$ 's (for all iterations of the outer `for` loop) from 1 to  $n - 1$ . The result is

$$\sum_{i=1}^{n-1} \frac{i+1}{2} = \frac{1}{2} \sum_{i=1}^{n-1} i + \sum_{i=1}^{n-1} \frac{1}{2} = \frac{\frac{1}{2}n(n-1)}{2} + \frac{1}{2}(n-1) = \frac{n^2+n-2}{4}$$

which is  $O(n^2)$  and approximately one-half of the number of comparisons in the worst case.

By similar reasoning, we can establish that, in iteration  $i$  of the outer `for` loop, `data[i]` can be moved either 0, 1, . . . , or  $i - 1$  times; that is

$$\frac{0+1+\dots+(i-1)}{i} = \frac{\frac{1}{2}i(i-1)}{i} = \frac{i-1}{2}$$

times plus two unconditional movements (to `tmp` and from `tmp`). Hence, in all the iterations of the outer `for` loop we have, on the average,

$$\sum_{i=1}^{n-1} \left( \frac{i-1}{2} + 2 \right) = \frac{1}{2} \sum_{i=1}^{n-1} i + \sum_{i=1}^{n-1} \frac{3}{2} = \frac{\frac{1}{2}n(n-1)}{2} + \frac{3}{2}(n-1) = \frac{n^2+5n-6}{4}$$

movements, which is also  $O(n^2)$ .

This answers the question: Is the number of movements and comparisons for a randomly ordered array closer to the best or to the worst case? Unfortunately, it is closer to the latter, which means that, on the average, when the size of an array is doubled, the sorting effort quadruples.

### 9.1.2 Selection Sort

Selection sort is an attempt to localize the exchanges of array elements by finding a misplaced element first and putting it in its final place. The element with the lowest value is selected and exchanged with the element in the first position. Then, for  $n = \text{data.length}$ , the smallest value among the remaining elements  $\text{data}[1], \dots, \text{data}[n-1]$  is found and put in the second position. This selection and placement by finding, in each pass  $i$ , the lowest value among the elements  $\text{data}[i], \dots, \text{data}[n-1]$  and swapping it with  $\text{data}[i]$  are continued until all elements are in their proper positions. The following pseudocode reflects the simplicity of the algorithm:

```
selectionsort(data[])
  for i = 0 to data.length-2
    select the smallest element among data[i], ..., data[data.length-1];
    swap it with data[i];
```

It is rather obvious that  $n-2$  should be the last value for  $i$ , because if all elements but the last have been already considered and placed in their proper positions, then the  $n$ th element (occupying position  $n-1$ ) has to be the largest. Here is a Java implementation of selection sort:

```
public void selectionsort(Object[] data) {
    int i,j,least;
    for (i = 0; i < data.length-1; i++) {
        for (j = i+1, least = i; j < data.length; j++)
            if (((Comparable)data[j]).compareTo(data[least]) < 0)
                least = j;
        if i != least)
            swap(data,least,i);
    }
}
```

where the method `swap()` exchanges elements `data[least]` and `data[i]`:

```
void swap(Object[] a, int e1, int e2) {
    Object tmp = a[e1]; a[e1] = a[e2]; a[e2] = tmp;
}
```

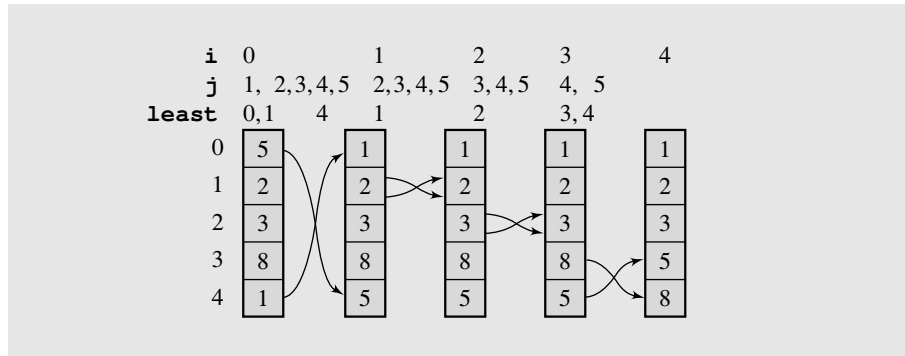
Note that `least` is not the smallest element but its position.

Figure 9.2 illustrates how the array `[5 2 3 8 1]` is sorted by selection sort.

The analysis of the performance of the method `selectionsort()` is simplified by the presence of two `for` loops with lower and upper bounds. The outer loop executes  $n - 1$  times, and for each  $i$  between 0 and  $n - 2$ , the inner loop iterates  $j = (n - 1) - i$  times. Because comparisons of keys are done in the inner loop, there are

$$\sum_{i=0}^{n-2} (n-1-i) = (n-1) + \dots + 1 = \frac{n(n-1)}{2} = O(n^2)$$

comparisons plus  $n - 1$  comparisons if indexes  $i$  and `least`. This number stays the same for all cases. There can be some savings only in the number of swaps.

**FIGURE 9.2** The array [5 2 3 8 1] sorted by selection sort.

In the best case, when an ordered array is sorted, no array elements are swapped. In the worst case, when the largest element is in the first position and the remaining elements are ordered, the swapping method is called as many times as the outer loop iterates, which is  $n - 1$ ; that is, in the worst case, the array elements are moved  $3(n - 1)$  times, which is  $O(n)$ , a very good result.

### 9.1.3 Bubble Sort

A bubble sort can be best understood if the array to be sorted is envisaged as a vertical column whose smallest elements are at the top and whose largest elements are at the bottom. The array is scanned from the bottom up, and two adjacent elements are interchanged if they are found to be out of order with respect to each other. First, items `data[n-1]` and `data[n-2]` are compared and swapped if they are out of order. Next, `data[n-2]` and `data[n-3]` are compared, and their order is changed if necessary, and so on up to `data[1]` and `data[0]`. In this way, the smallest element is bubbled up to the top of the array.

However, this is only the first pass through the array. The array is scanned again comparing consecutive items and interchanging them when needed, but this time, the last comparison is done for `data[2]` and `data[1]` because the smallest element is already in its proper position, namely, position 0. The second pass bubbles the second smallest element of the array up to the second position, position 1. The procedure continues until the last pass when only one comparison, `data[n-1]` with `data[n-2]`, and possibly one interchange are performed.

A pseudocode of the algorithm is as follows:

```

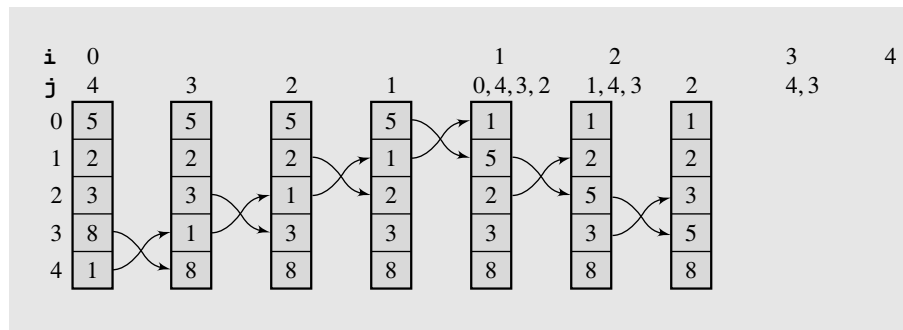
bubblesort(data[])
  for i = 0 to data.length-2
    for j = data.length-1 downto i+1
      swap elements in position j and j-1 if they are out of order;

```

Figure 9.3 illustrates the changes performed in the integer array [5 2 3 8 1] during the execution of `bubblesort()`. Here is an implementation of bubble sort:

```
public void bubblesort(Object[] data) {
    for (int i = 0; i < data.length-1; i++)
        for (int j = data.length-1; j > i; --j)
            if (((Comparable)data[j]).compareTo(data[j-1]) < 0)
                swap(data, j, j-1);
}
```

**FIGURE 9.3** The array [5 2 3 8 1] sorted by bubble sort.



The number of comparisons is the same in each case (best, average, and worst) and equals the total number of iterations of the inner `for` loop:

$$\sum_{i=0}^{n-2} (n-1-i) = \frac{n(n-1)}{2} = O(n^2)$$

This formula also computes the number of swaps in the worst case when the array is in reverse order. In this case,  $\frac{n(n-1)}{2}$  moves have to be made.

The best case, when all elements are already ordered, requires no swaps. To find the number of moves in the average case, note if an *i*-cell array is in random order. Then the number of swaps can be any number between zero and *i* - 1; that is, there can be either no swap at all (all items are in ascending order), one swap, two swaps, . . . , or *i* - 1 swaps. The array processed by the inner `for` loop is `data[i]`, . . . , `data[n-1]`, and the number of swaps in this subarray—if its elements are randomly ordered—is either zero, one, two, . . . , or *n* - 1 - *i*. After averaging the sum of all these possible numbers of swaps by the number of these possibilities, the average number of swaps is obtained, which is

$$\frac{0 + 1 + 2 + \cdots + (n-1-i)}{n-i} = \frac{n-i-1}{2}$$

If all these averages for all the subarrays processed by `bubblesort()` are added (that is, if such figures are summed over all iterations *i* of the outer `for` loop), the result is

$$\begin{aligned} \sum_{i=0}^{n-2} \frac{n-i-1}{2} &= \frac{1}{2} \sum_{i=0}^{n-2} (n-1) - \frac{1}{2} \sum_{i=0}^{n-2} i \\ &= \frac{(n-1)^2}{2} - \frac{(n-1)(n-2)}{4} = \frac{n(n-1)}{4} \end{aligned}$$

swaps, which is equal to  $\frac{3}{4}n(n-1)$  moves.

The main disadvantage of bubble sort is that it still painstakingly bubbles items step by step up toward the top of the array. It looks at two adjacent array elements at a time and swaps them if they are not in order. If an element has to be moved from the bottom to the top, it is exchanged with every element in the array. It does not skip them as selection sort did. In addition, the algorithm concentrates only on the item that is being bubbled up. Therefore, all elements that distort the order are moved, even those that are already in their final positions (see numbers 2 and 3 in Figure 9.3, the situation analogous to that in insertion sort).

What is bubble sort's performance in comparison to insertion and selection sort? In the average case, bubble sort makes approximately twice as many comparisons and the same number of moves as insertion sort, as many comparisons as selection sort, and  $n$  times more moves than selection sort.

It could be said that insertion sort is twice as fast as bubble sort. In fact it is, but this fact does not immediately follow from the performance estimates. The point is that when determining a formula for the number of comparisons, only comparisons of data items have been included. The actual implementation for each algorithm involves more than just that. In `bubblesort()`, for example, there are two loops, both of which compare indexes: `i` and `data.length-1` in the first loop, `j` and `i` in the second. All in all, there are  $\frac{n(n-1)}{2}$  such comparisons, and this number should not be treated too lightly, particularly if `data` consists of integers, because then comparing the data takes a similar amount of time as comparing indexes. A more thorough treatment of the problem of efficiency should focus on more than just data comparison and exchange. It should also include the overhead necessary for implementation of the algorithm.

## 9.2 DECISION TREES

The three sorting methods analyzed in previous sections were not very efficient. This leads to several questions: Can any better level of efficiency for a sorting algorithm be expected? Can algorithms, at least theoretically, be more efficient by executing faster? If so, when can we be satisfied with an algorithm and be sure that the sorting speed is unlikely to be increased? We need a quantitative measurement to estimate a *lower bound* of sorting speed.

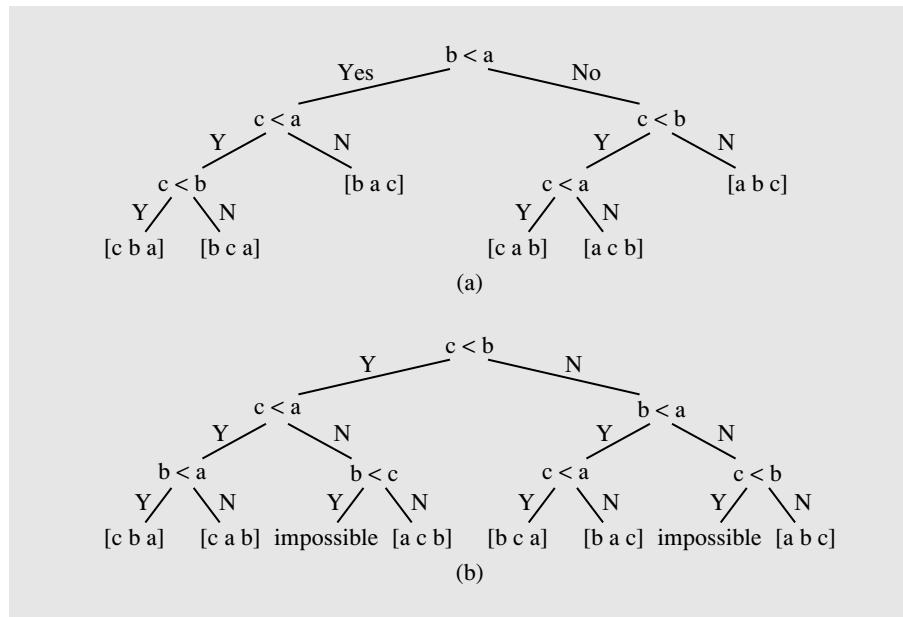
This section focuses on the comparisons of two elements and not the element interchange. The questions are: On the average, how many comparisons have to be made to sort  $n$  elements? Or what is the best estimate of the number of item comparisons if an array is assumed to be ordered randomly?

Every sorting algorithm can be expressed in terms of a binary tree in which the arcs carry the labels Y(es) or N(o). Nonterminal nodes of the tree contain conditions

or queries for labels, and the leaves have all possible orderings of the array to which the algorithm is applied. This type of tree is called a *decision tree*. Because the initial ordering cannot be predicted, all possibilities have to be listed in the tree in order for the sorting procedure to grapple with any array and any possible initial order of data. This initial order determines which path is taken by the algorithm and what sequence of comparisons is actually chosen. Note that different trees have to be drawn for arrays of different length.

Figure 9.4 illustrates decision trees for insertion sort and bubble sort for an array [a b c]. The tree for insertion sort has six leaves, and the tree for bubble sort has eight leaves. How many leaves does a tree for an  $n$ -element array have? Such an array can be ordered in  $n!$  different ways, as many ways as the possible permutations of the array elements, and all of these orderings have to be stored in the leaves of the decision tree. Thus, the tree for insertion sort has six leaves because  $n = 3$ , and  $3! = 6$ .

**FIGURE 9.4** Decision trees for (a) insertion sort and (b) bubble sort as applied to the array [a b c].



But as the example of the decision tree for bubble sort indicates, the number of leaves does not have to equal  $n!$ . In fact, it is never less than  $n!$ , which means that it can be greater than  $n!$ . This is a consequence of the fact that a decision tree can have leaves corresponding to failures, not only to possible orderings. The failure nodes are reached by an inconsistent sequence of operations. Also, the total number of leaves can be greater than  $n!$  because some orderings (permutations) can occur in more than one leaf, because the comparisons may be repeated.



One of the interesting properties of decision trees is the average number of arcs traversed from the root to reach a leaf. Because one arc represents one comparison, the average number of arcs reflects the average number of key comparisons when executing a sorting algorithm.

As already established in Chapter 6, an  $i$ -level complete decision tree has  $2^{i-1}$  leaves,  $2^{i-1} - 1$  nonterminal nodes (for  $i \geq 1$ ) and  $2^i - 1$  total nodes. Because all non-complete trees with the same number of  $i$  levels have fewer nodes than that,  $k + m \leq 2^i - 1$ , where  $m$  is the number of leaves and  $k$  is the number of nonleaves. Also,  $k \leq 2^{i-1} - 1$  and  $m \leq 2^{i-1}$  (Section 6.1 and Figure 6.5). The latter inequality is used as an approximation for  $m$ . Hence, in an  $i$ -level decision tree, there are at most  $2^{i-1}$  leaves.

Now, a question arises: What is a relationship between the number of leaves of a decision tree and the number of all possible orderings of an  $n$ -element array? There are  $n!$  possible orderings, and each one of them is represented by a leaf in a decision tree. But the tree may also have some extra nodes due to repetitions and failures. Therefore,  $n! \leq m \leq 2^{i-1}$ , or  $2^{i-1} \geq n!$ . This inequality answers the following question: How many comparisons are performed when using a certain sorting algorithm for an  $n$ -element array in the worst case? Or rather, what is the lowest or the best figure expected in the worst case? Note that this analysis pertains to the worst case. We assume that  $i$  is a level of a tree regardless of whether or not it is complete;  $i$  always refers to the longest path leading from the root of the tree to the lowest tree level, which is also the largest number of comparisons needed to reach an ordered configuration of array stored in the root. First, the inequality  $2^{i-1} \geq n!$  is transformed into  $i - 1 \geq \lg(n!)$ , which means that the path length in a decision tree with at least  $n!$  leaves must be at least  $\lg(n!)$ , or rather, it must be  $\lceil \lg(n!) \rceil$ , where  $\lceil x \rceil$  is an integer not less than  $x$ . See the example in Figure 9.5.

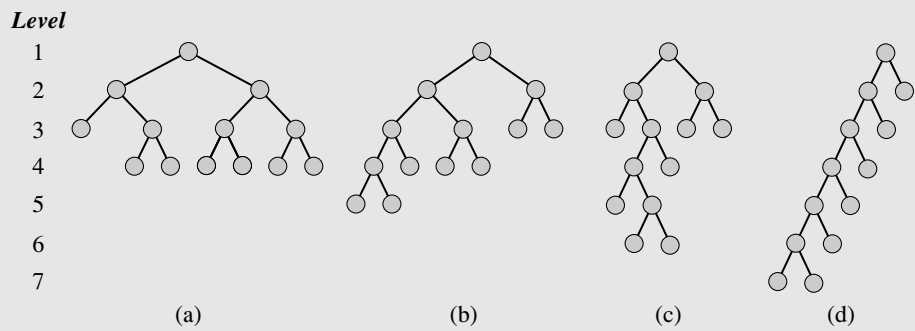
It can be proven that, for a randomly chosen leaf of an  $m$ -leaf decision tree, the length of the path from the root to the leaf is not less than  $\lg m$  and that, both in the average case and the worst case, the required number of comparisons,  $\lg(n!)$ , is  $O(n \lg n)$  (see Section A.2 in Appendix A). That is,  $O(n \lg n)$  is also the best that can be expected in average cases.

It is interesting to compare this approximation to some of the numbers computed for sorting methods, especially for the average and worst cases. For example, insertion sort requires only  $n - 1$  comparisons in the best case, but in the average and the worst cases, this sort turns into an  $n^2$  algorithm because the functions relating the number of comparisons to the number of elements are, for these cases, the big-Os of  $n^2$ . This is much greater than  $n \lg n$ , especially for large numbers. Consequently, insertion sort is not an ideal algorithm. The quest for better methods can be continued with at least the expectation that the number of comparisons should be approximated by  $n \lg n$  rather than by  $n^2$ .

The difference between these two functions is best seen in Figure 9.6 if the performance of the algorithms analyzed so far is compared with the expected performance  $n \lg n$  in the average case. The numbers in the table in Figure 9.6 show that if 100 items are sorted, the desired algorithm is four times faster than insertion sort and eight times faster than selection sort and bubble sort. For 1,000 items, it is 25 and 50 times faster, respectively. For 10,000, the difference in performance differs by factors of 188 and 376, respectively. This can only serve to encourage the search for an algorithm embodying the performance of the function  $n \lg n$ .

**FIGURE 9.5** Examples of decision trees for an array of three elements.

These are some possible decision trees for an array of three elements. These trees must have at least  $3! = 6$  leaves. For the sake of the example, it is assumed that each tree has one extra leaf (a repetition or a failure). In the worst and average cases, the number of comparisons is  $i - 1 \geq \lceil \lg(n!) \rceil$ . In this example,  $n = 3$ , so  $i - 1 \geq \lceil \lg 3! \rceil = \lceil \lg 6 \rceil \approx \lceil 2.59 \rceil = 3$ . And, in fact, only for the best balanced tree (a), the nonrounded length of the average path is less than three.



These are the sums of the lengths of the paths from the root to all leaves in trees (a) – (d) and the average path lengths:

- (a)  $2 + 3 + 3 + 3 + 3 + 3 + 3 = 20$ ; average  $= \frac{20}{7} \approx 2.86$
- (b)  $4 + 4 + 3 + 3 + 3 + 2 + 2 = 21$ ; average  $= \frac{21}{7} = 3$
- (c)  $2 + 4 + 5 + 5 + 3 + 2 + 2 = 23$ ; average  $= \frac{23}{7} \approx 3.29$
- (d)  $6 + 6 + 5 + 4 + 3 + 2 + 1 = 27$ ; average  $= \frac{27}{7} \approx 3.86$

**FIGURE 9.6** Number of comparisons performed by the simple sorting method and by an algorithm whose efficiency is estimated by the function  $n \lg n$ .

sort type	$n$	100	1,000	10,000
insertion	$\frac{n(n-1)}{4}$	2,475	249,750	24,997,500
selection, bubble	$\frac{n(n-1)}{2}$	4,950	499,500	49,995,000
expected	$n \lg n$	664	9,966	132,877

## 9.3 EFFICIENT SORTING ALGORITHMS

### 9.3.1 Shell Sort

The  $O(n^2)$  limit for a sorting method is much too large and must be broken to improve efficiency and decrease run time. How can this be done? The problem is that the time required for ordering an array by the three sorting algorithms usually grows faster than the size of the array. In fact, it is customarily a quadratic function of that size. It may turn out to be more efficient to sort parts of the original array first and then, if they are at least partially ordered, to sort the entire array. If the subarrays are already sorted, we are that much closer to the best case of an ordered array than initially. A general outline of such a procedure is as follows:

```

divide data into h subarrays;
for i = 1 to h
    sort subarray datai;
sort array data;

```

If  $h$  is too small, then the subarrays  $\text{data}_i$  of array  $\text{data}$  could be too large, and sorting algorithms might prove inefficient as well. On the other hand, if  $h$  is too large, then too many small subarrays are created, and although they are sorted, it does not substantially change the overall order of  $\text{data}$ . Lastly, if only one such partition of  $\text{data}$  is done, the gain on the execution time may be rather modest. To solve that problem, several different subdivisions are used, and for every subdivision, the same procedure is applied separately, as in:

```

determine numbers ht . . . h1 of ways of dividing array data into subarrays;
for (h=ht; t > 1; t--, h=ht)
    divide data into h subarrays;
    for i = 1 to h
        sort subarray datai;
sort array data;

```

This idea is the basis of the *diminishing increment sort*, also known as *Shell sort* and named after Donald L. Shell who designed this technique. Note that this pseudocode does not identify a specific sorting method for ordering the subarrays; it can be any simple method. Usually, however, Shell sort uses insertion sort.

The heart of Shell sort is an ingenious division of the array  $\text{data}$  into several subarrays. The trick is that elements spaced further apart are compared first, then the elements closer to each other are compared, and so on, until adjacent elements are compared on the last pass. The original array is logically subdivided into subarrays by picking every  $h_t$ th element as part of one subarray. Therefore, there are  $h_t$  subarrays, and for every  $h = 1, \dots, h_t$ ,

$$\text{data}_{h_t h}[i] = \text{data}[h_t \cdot i + (h - 1)]$$

For example, if  $h_t = 3$ , the array  $\text{data}$  is subdivided into three subarrays  $\text{data}_1$ ,  $\text{data}_2$ , and  $\text{data}_3$ , so that

```

data31[0] = data[0], data31[1] = data[3], ..., data31[i] = data[3*i], ...
data32[0] = data[1], data32[1] = data[4], ..., data32[i] = data[3*i+1], ...
data33[0] = data[2], data33[1] = data[5], ..., data33[i] = data[3*i+2], ...
    
```

and these subarrays are sorted separately. After that, new subarrays are created with an  $h_{t-1} < h_t$ , and insertion sort is applied to them. The process is repeated until no subdivisions can be made. If  $h_t = 5$ , the process of extracting subarrays and sorting them is called a 5-sort.

Figure 9.7 shows the elements of the array `data` that are five positions apart and are logically inserted into a separate array—“logically” because physically they still occupy the same positions in `data`. For each value of increment  $h_t$ , there are  $h_t$  subarrays, and each of them is sorted separately. As the value of the increment decreases, the number of subarrays decreases accordingly, and their sizes grow. Much of `data`’s disorder has been removed in the earlier iterations, so on the last pass, the array is much closer to its final form than before all the intermediate  $h$ -sorts.

**FIGURE 9.7** The array [10 8 6 20 4 3 22 1 0 15 16] sorted by Shell sort.

<code>data</code> before 5-sort	10	8	6	20	4	3	22	1	0	15	16
Five subarrays before sorting	10	—	—	—	—	3	—	—	—	—	16
		8	—	—	—	—	22				
			6	—	—	—	—	1			
				20	—	—	—	—	0		
					4	—	—	—	—	15	
Five subarrays after sorting	3	—	—	—	—	10	—	—	—	—	16
		8	—	—	—	—	22				
			1	—	—	—	—	6			
				0	—	—	—	—	20		
					4	—	—	—	—	15	
<code>data</code> after 5-sort and before 3-sort	3	8	1	0	4	10	22	6	20	15	16
Three subarrays before sorting	3	—	—	0	—	—	22	—	—	15	
		8	—	—	4	—	—	6	—	—	16
			1	—	—	10	—	—	20		
Three subarrays after sorting	0	—	—	3	—	—	15	—	—	22	
		4	—	—	6	—	—	8	—	—	16
			1	—	—	10	—	—	20		
<code>data</code> after 3-sort and before 1-sort	0	4	1	3	6	10	15	8	20	22	16
<code>data</code> after 1-sort	0	1	3	4	6	8	10	15	16	20	22

One problem still has to be addressed, namely, choosing the optimal value of the increment. In the example in Figure 9.7, the value of 5 is chosen to begin with, then 3, and 1 is used for the final sort. But why these values? Unfortunately, no convincing answer can be given. In fact, any decreasing sequence of increments can be used as long as the last one,  $h_1$ , is equal to 1. Donald Knuth has shown that even if there are only two increments,  $(\frac{16n}{\pi})^{\frac{1}{3}}$  and 1, Shell sort is more efficient than insertion sort because it takes  $O(n^{\frac{5}{3}})$  time instead of  $O(n^2)$ . But the efficiency of Shell sort can be improved by using a larger number of increments. It is imprudent, however, to use sequences of increments such as 1, 2, 4, 8, . . . or 1, 3, 6, 9, . . . because the mixing effect of data is lost.

For example, when using 4-sort and 2-sort, a subarray,  $\text{data}_{2,p}$  for  $i = 1, 2$ , consists of elements of two arrays,  $\text{data}_{4,i}$  and  $\text{data}_{4,j}$  where  $j = i + 2$ , and only those. It is much better if elements of  $\text{data}_{4,i}$  do not meet together again in the same array because a faster reduction in the number of exchange inversions is achieved if they are sent to different arrays when performing the 2-sort. Using only powers of 2 for the increments, as in Shell's original algorithm, the items in the even and odd positions of the array do not interact until the last pass, when the increment equals 1. This is where the mixing effect (or lack thereof) comes into play. But there is no formal proof indicating which sequence of increments is optimal. Extensive empirical studies along with some theoretical considerations suggest that it is a good idea to choose increments satisfying the conditions

$$h_1 = 1$$

$$h_{i+1} = 3h_i + 1$$

and stop with  $h_i$  for which  $h_{i+2} \geq n$ . For  $n = 10,000$ , this gives the sequence

$$1, 4, 13, 40, 121, 364, 1093, 3280$$

Experimental data have been approximated by the exponential function, the estimate,  $1.21n^{\frac{5}{3}}$ , and the logarithmic function  $.39n \ln^2 n - 2.33n \ln n = O(n \ln^2 n)$ . The first form fits the results of the tests better.  $1.21n^{1.25} = O(n^{1.25})$  is much better than  $O(n^2)$  for insertion sort, but it is still much greater than the expected  $O(n \lg n)$  performance.

Figure 9.8 contains a function to sort the array `data` using Shell sort. Note that before sorting starts, increments are computed and stored in the array `increments`.

The core of Shell sort is to divide an array into subarrays by taking elements  $h$  positions apart. Three features of this algorithm vary from one implementation to another:

1. The sequence of increments
2. A simple sorting algorithm applied in all passes except the last
3. A simple sorting algorithm applied only in the last pass, for 1-sort

In our implementation, as in Shell's, insertion sort is applied in all  $h$ -sorts, but other sorting algorithms can be used. For example, Dobosiewicz uses bubble sort for the last pass and insertion sort for other passes. Incerpi and Sedgewick use two iterations of cocktail shaker sort, a version of bubble sort in each  $h$ -sort, and finish with insertion sort, obtaining what they call a *shakersort*. All these versions perform better than simple sorting methods, although there are some differences in performance among versions. Analytical results concerning the complexity of these sorts are not available. All results regarding complexity are of an empirical nature.

**FIGURE 9.8** Implementation of Shell sort.

```

void Shellsort (Object[] data) {
    int i, j, k, h, hCnt, increments[] = new int[20];
    // create an appropriate number of increments h
    for (h = 1, i = 0; h < data.length; i++) {
        increments[i] = h;
        h = 3*h + 1;
    }
    // loop on the number of different increments h
    for (i--; i >= 0; i--) {
        h = increments[i];
        // loop on the number of subarrays h-sorted in ith pass
        for (hCnt = h; hCnt < 2*h; hCnt++) {
            // insertion sort for subarray containing every hth element
            // of array data
            for (j = hCnt; j < data.length; ) {
                Comparable tmp = (Comparable)data[j];
                k = j;
                while (k-h >= 0 && tmp.compareTo(data[k-h]) < 0) {
                    data[k] = data[k-h];
                    k -= h;
                }
                data[k] = tmp;
                j += h;
            }
        }
    }
}

```

### 9.3.2 Heap Sort

Selection sort makes  $O(n^2)$  comparisons and is very inefficient, especially for large  $n$ . But it performs relatively few moves. If the comparison part of the algorithm is improved, the end results can be promising.

*Heap sort* was invented by John Williams and uses the approach inherent to selection sort. Selection sort finds among the  $n$  elements the one that precedes all other  $n - 1$  elements, then the least element among those  $n - 1$  items, and so forth, until the array is sorted. To have the array sorted in ascending order, heap sort puts the largest element at the end of the array, then the second largest in front of it, and so on. Heap sort starts from the end of the array by finding the largest elements, whereas selection sort starts from the beginning using the smallest elements. The final order in both cases is indeed the same.

Heap sort uses a heap as described in Section 6.9. A heap is a binary tree with the following two properties:

1. The value of each node is not less than the values stored in each of its children.
2. The tree is perfectly balanced and the leaves in the last level are all in the leftmost positions.

A tree has the heap property if it satisfies condition 1. Both conditions are useful for sorting, although this is not immediately apparent for the second condition. The goal is to use only the array being sorted without using additional storage for the array elements; by condition 2, all elements are located in consecutive positions in the array starting from position 0, with no unused position inside the array. In other words, condition 2 reflects the packing of an array with no gaps.

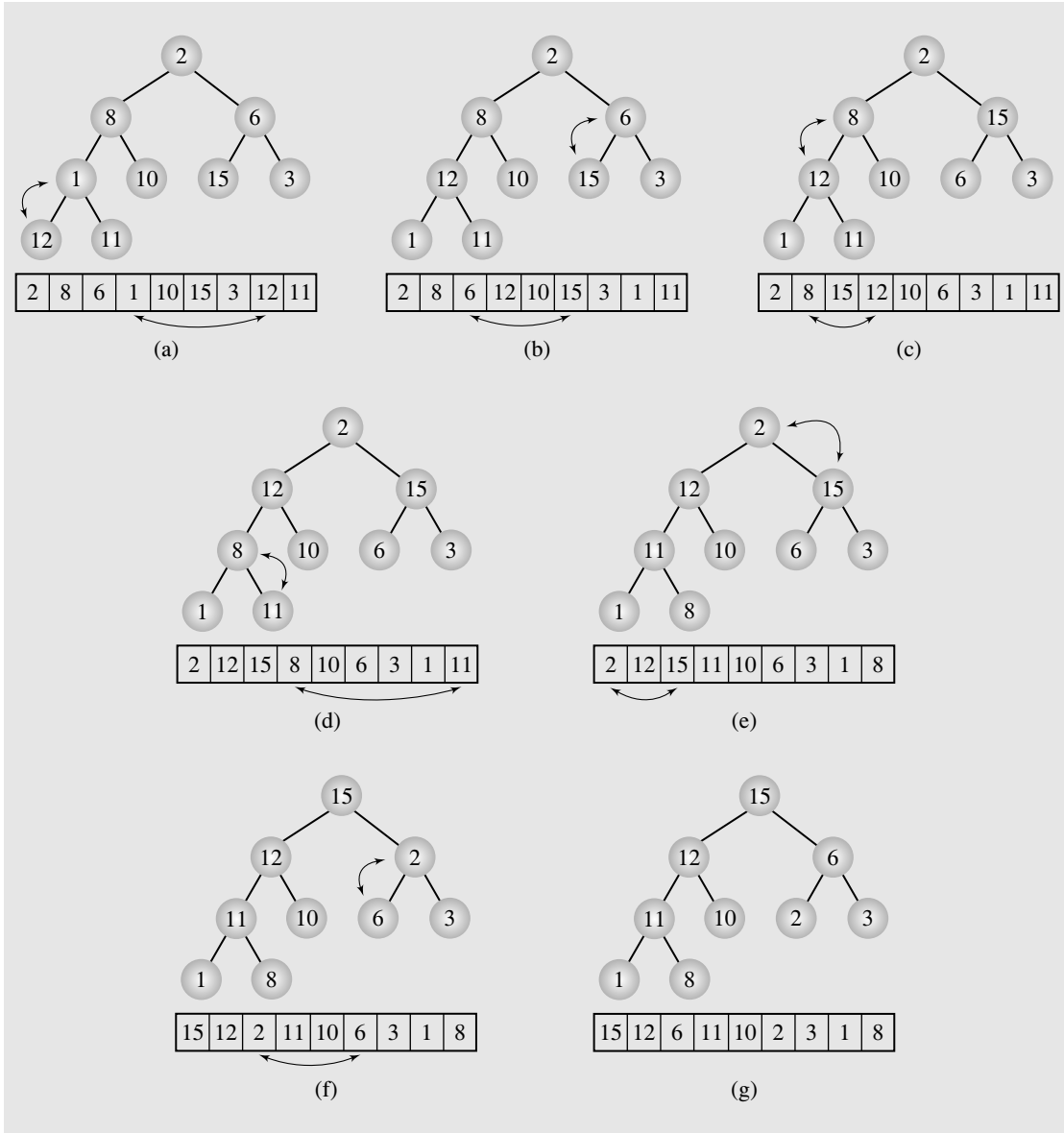
Elements in a heap are not perfectly ordered. It is known only that the largest element is in the root node and that, for each other node, all its descendants are not greater than the element in this node. Heap sort thus starts from the heap, puts the largest element at the end of the array, and restores the heap that now has one less element. From the new heap, the largest element is removed and put in its final position, and then the heap property is restored for the remaining elements. Thus, in each round, one element of the array ends up in its final position, and the heap becomes smaller by this one element. The process ends with exhausting all elements from the heap and is summarized in the following pseudocode:

```
heapsort(data[])
    transform data into a heap;
    for i = data.length-1 downto 2
        swap the root with the element in position i;
        restore the heap property for the tree data[0], ..., data[i-1];
```

In the first phase of heap sort, an array is transformed into a heap. In this process, we use a bottom-up method devised by Floyd and described in Section 6.9.2. All steps leading to the transformation of the array [2 8 6 1 10 15 3 12 11] into a heap are illustrated in Figure 9.9 (cf. Figure 6.58).

The second phase begins after the heap has been built (Figures 9.9g and 9.10a). At that point, the largest element, number 15, is moved to the end of the array. Its place is taken by 8, thus violating the heap property. The property has to be restored, but this time it is done for the tree without the largest element, 15. Because it is already in its proper position, it does not need to be considered anymore and is removed (pruned) from the tree (indicated by the dashed lines in Figure 9.10). Now, the largest element among `data[0], ..., data[n-2]` is looked for. To that end, the method `moveDown()` from Section 6.9 (Figure 6.56) is called to construct a heap out of all the elements of `data` except the last, `data[n-1]`, which results in the heap in Figure 9.10c. Number 12 is sifted up and then swapped with 1, giving the tree in Figure 9.10d. The method `moveDown()` is called again to select 11 (Figure 9.10e), and the element is swapped with the last element of the current subarray, which is 3 (Figure 9.10f). Now 10 is selected (Figure 9.10g) and exchanged with 2 (Figure 9.10h). The reader can easily construct trees and heaps for the next passes through the loop of `heapsort()`. After the last pass, the array is in

**FIGURE 9.9** Transforming the array [2 8 6 1 10 15 3 12 11] into a heap.

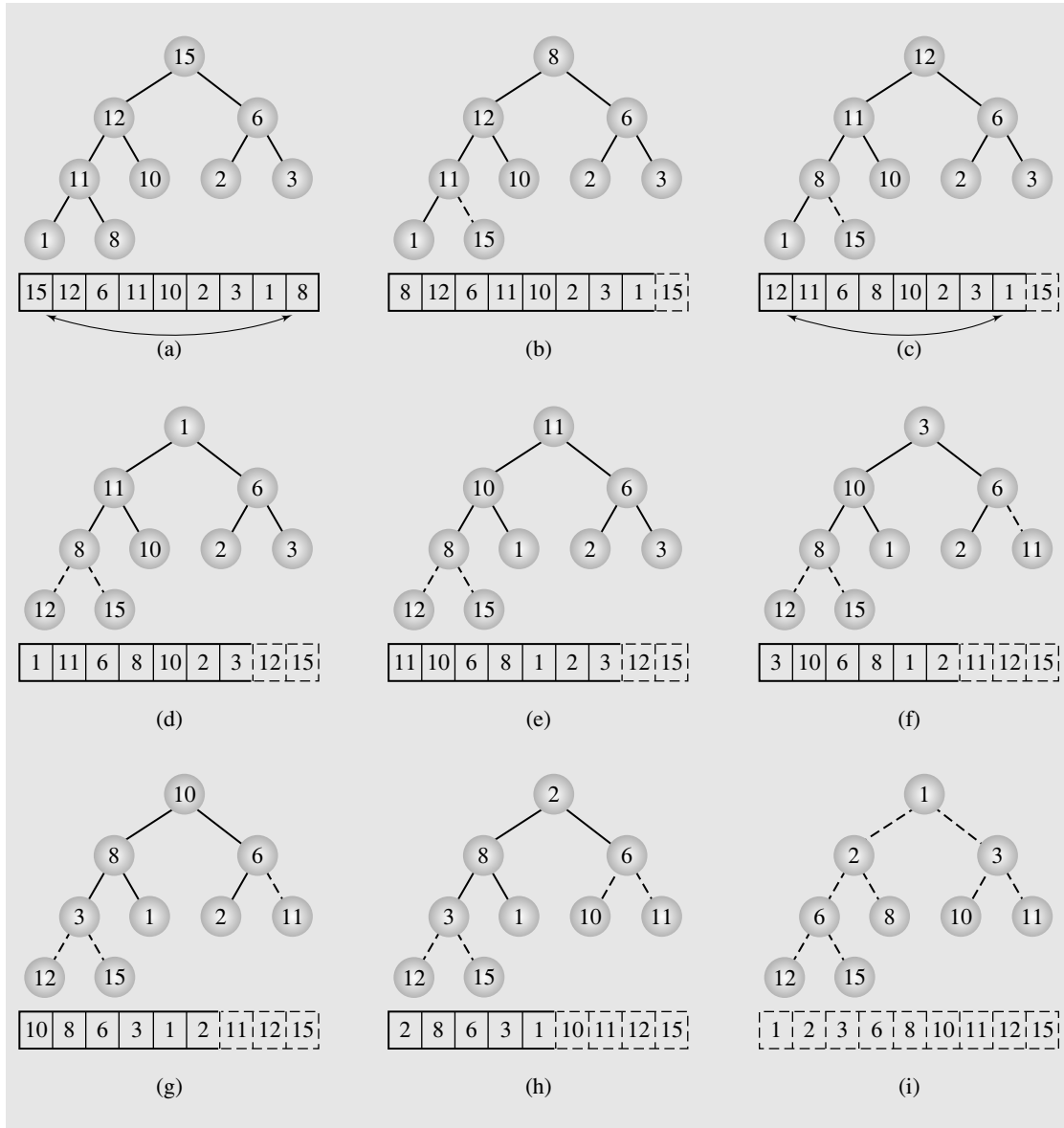


ascending order and the tree is ordered accordingly. An implementation of `heapsort()` is as follows:

```
void heapsort(Object[] data) {
    for (int i = data.length/2 - 1; i >= 0; --i)
        moveDown(data,i,data.length-1);
}
```



**FIGURE 9.10** Execution of heap sort on the array [15 12 6 11 10 2 3 1 8], which is the heap constructed in Figure 9.9.



```

for (int i = data.length-1; i >= 1; --i) {
    swap(data,0,i);
    moveDown(data,0,i-1);
}
}

```

Heap sort might be considered inefficient because the movement of data seems to be very extensive. First, all effort is applied to moving the largest element to the left-most side of the array in order to move it to the furthest right. But therein lies its efficiency. In the first phase, to create the heap, `heapsort()` uses `moveDown()`, which performs  $O(n)$  steps (see Section 6.9.2).

In the second phase, `heapsort()` exchanges  $n - 1$  times the root with the element in position  $i$  and also restores the heap  $n - 1$  times, which in the worst case causes `moveDown()` to iterate  $\lg i$  times to bring the root down to the level of the leaves. Thus, the total number of moves in all executions of `moveDown()` in the second phase of `heapsort()` is  $\sum_{i=1}^{n-1} \lg i$ , which is  $O(n \lg n)$ . In the worst case, `heapsort()` requires  $O(n)$  steps in the first phase, and in the second phase,  $n - 1$  swaps and  $O(n \lg n)$  operations to restore the heap property. This gives  $O(n) + O(n \lg n) + (n - 1) = O(n \lg n)$  exchanges for the whole process in the worst case.

For the best case, when the array contains identical elements, `moveDown()` is called  $\frac{n}{2}$  times in the first phase, but no moves are performed. In the second phase, `heapsort()` makes one swap to move the root element to the end of the array, resulting in only  $n - 1$  moves. Also, in the best case,  $n$  comparisons are made in the first phase and  $2(n - 1)$  in the second. Hence, the total number of comparisons in the best case is  $O(n)$ . However, if the array has distinct elements, then in the best case the number of comparisons equals  $n \lg n - O(n)$  (Ding and Weiss 1992).

### 9.3.3 Quicksort

Shell sort approached the problem of sorting by dividing the original array into subarrays, sorting them separately, and then dividing them again to sort the new subarrays until the whole array is sorted. The goal was to reduce the original problem to subproblems that can be solved more easily and quickly. The same reasoning was a guiding principle for C. A. R. Hoare, who invented an algorithm appropriately called *quicksort*.

The original array is divided into two subarrays, the first of which contains elements less than or equal to a chosen key called the *bound* or *pivot*. The second subarray includes elements equal to or greater than the bound. The two subarrays can be sorted separately, but before this is done, the partition process is repeated for both subarrays. As a result, two new bounds are chosen, one for each subarray. The four subarrays are created because each subarray obtained in the first phase is now divided into two segments. This process of partitioning is carried down until there are only one-cell arrays that do not need to be sorted at all. By dividing the task of sorting a large array into two simpler tasks and then dividing those tasks into even simpler tasks, it turns out that in the process of getting prepared to sort, the data have already been sorted. Because the sorting has been somewhat dissipated in the preparation process, this process is the core of quicksort.

Quicksort is recursive in nature because it is applied to both subarrays of an array at each level of partitioning. This technique is summarized in the following pseudocode:

```
quicksort(array[])
  if array.length > 1
    choose bound; // partition array into subarray1 and subarray2
    while there are elements left in array
```

```

    include element either in subarray1 = {el: el ≤ bound}
    or in subarray2 = {el: el ≥ bound};
quicksort(subarray1);
quicksort(subarray2);

```

To partition an array, two operations have to be performed: A bound has to be found and the array has to be scanned to place the elements in the proper subarrays. However, choosing a good bound is not a trivial task. The problem is that the subarrays should be approximately the same length. If an array contains the numbers 1 through 100 (in any order) and 2 is chosen as a bound, then an imbalance results: The first subarray contains only 1 number after partitioning, whereas the second has 99 numbers.

A number of different strategies for selecting a bound have been developed. One of the simplest consists of choosing the first element of an array. That approach can suffice for some applications; however, because many arrays to be sorted already have many elements in their proper positions, a more cautious approach is to choose the element located in the middle of the array. This approach is incorporated in the implementation in Figure 9.11.

---

**FIGURE 9.11** Implementation of quicksort.

```

void quicksort(Object[] data, int first, int last) {
    int lower = first + 1, upper = last;
    swap(data, first, (first+last)/2);
    Comparable bound = (Comparable)data[first];
    while (lower <= upper) {
        while bound.compareTo(data[upper])
            lower++;
        while (bound.compareTo(data[lower]) > 0)
            upper--;
        if (lower < upper)
            swap(data, lower++, upper--);
        else lower++;
    }
    swap(data, upper, first);
    if (first < upper-1)
        quicksort(data, first, upper-1);
    if (upper+1 < last)
        quicksort(data, upper+1, last);
}
void quicksort(Object[] data) {
    if (data.length < 2)

```

*Continues*

**FIGURE 9.11** (continued)

```

        return;
    int max = 0;
    // find the largest element and put it at the end of data;
    for (int i = 1; i < data.length; i++)
        if (((Comparable)data[max]).compareTo(data[i]) < 0)
            max = i;
    swap(data,data.length-1,max); // largest el is now in its
    quicksort(data,0,data.length-2); // final position;
}

```

Another task is scanning the array and dividing the elements between its two subarrays. The pseudocode is vague about how this can be accomplished. In particular, it does not decide where to place an element equal to the bound. It only says that elements are placed in the first subarray if they are less than or the same as the bound and in the second if they are greater than or the same as the bound. The reason is that the difference between the lengths of the two subarrays should be minimal. Therefore, elements equal to the bound should be so divided between the two subarrays as to make this difference in size minimal. The details of handling this depend on a particular implementation, and one such implementation is given in Figure 9.11. In this implementation, `quicksort(data[ ])` preprocesses the array to be sorted by locating the largest element in the array and exchanging it with the last element of the array. Having the largest element at the end of the array prevents the index `lower` from running off the end of the array. This could happen in the first inner `while` loop if the bound were the largest element in the array. The index `lower` would be constantly incremented, eventually causing an abnormal program termination by raising the `ArrayIndexOutOfBoundsException`. Without this preprocessing, the first inner `while` loop would have to be

```
while (lower < last && bound.compareTo(data[lower]) > 0)
```

The first test, however, would be necessary only in extreme cases, but it would be executed in each iteration of this `while` loop.

In this implementation, the main property of the bound is used, namely, that it is a boundary item. Hence, as befits the boundary item, it is placed on the borderline between the two subarrays obtained as a result of one call to `quicksort()`. In this way, the bound is located in its final position and can be excluded from further processing. To ensure that the bound is not moved around, it is stashed in the first position, and after partitioning is done, it is moved to its proper position, which is the rightmost position of the first subarray.

Figure 9.12 contains an example of partitioning the array [8 5 4 7 6 1 6 3 8 12 10]. In the first partitioning, the largest element in the array is located and exchanged with the last element, resulting in the array [8 5 4 7 6 1 6 3 8 10 12]. Because the last element



moves `lower` to position 3 with 7, which is greater than the bound. The second inner `while` loop moves `upper` to position 7 with 3, which is less than the bound (Figure 9.12c). Next the elements in these two cells are exchanged, giving the array [6 5 4 3 8 1 6 7 8 10 12] (Figure 9.12d). Then `lower` is incremented to 4 and `upper` is decremented to 6 (Figure 9.12e). This concludes the first iteration of the outer `while` loop.

In its second iteration, neither of the two inner `while` loops modifies any of the two indexes because `lower` indicates a position occupied by 8, which is greater than the bound, and `upper` indicates a position occupied by 6, which is equal to the bound. The two numbers are exchanged (Figure 9.12f), and then both indexes are updated to 5 (Figure 9.12g).

In the third iteration of the outer `while` loop, `lower` is moved to the next position containing 8, which is greater than the bound, and `upper` stays in the same position because 1 in this position is less than the bound (Figure 9.12h). But at that point, `lower` and `upper` cross each other, so no swapping takes place, and after a redundant increment of `lower` to 7, the outer `while` loop is exited. At that point, `upper` is the index of the rightmost element of the first subarray (with the element not exceeding the bound), so the element in this position is exchanged with the bound (Figure 9.12i). In this way, the bound is placed in its final position and can be excluded from subsequent processing. Therefore, the two subarrays that are processed next are the left subarray, with elements to the left of the bound, and the right subarray, with elements to its right (Figure 9.12j). Then partitioning is performed for these two subarrays separately, and then for subarrays of these subarrays, until subarrays have less than two elements. The entire process is summarized in Figure 9.13, in which all the changes in all current arrays are indicated.

The worst case occurs if in each invocation of `quicksort()`, the smallest (or largest) element of the array is chosen for the bound. This is the case if we try to sort the array [5 3 1 2 4 6 8]. The first bound is 1, and the array is broken into an empty array and the array [3 5 2 4 6] (the largest number, 8, does not participate in partitioning). The new bound is 2, and again only one nonempty array, [5 3 4 6], is obtained as the result of partitioning. The next bound and array returned by partition are 3 and [5 4 6], then 4 and [5 6], and finally 5 and [6]. The algorithm thus operates on arrays of size  $n - 1, n - 2, \dots, 2$ . The partitions require  $n - 2 + n - 3 + \dots + 1$  comparisons, and for each partition, only the bound is placed in the proper position. This results in a run time equal to  $O(n^2)$ , which is hardly a desirable result, especially for large arrays or files.

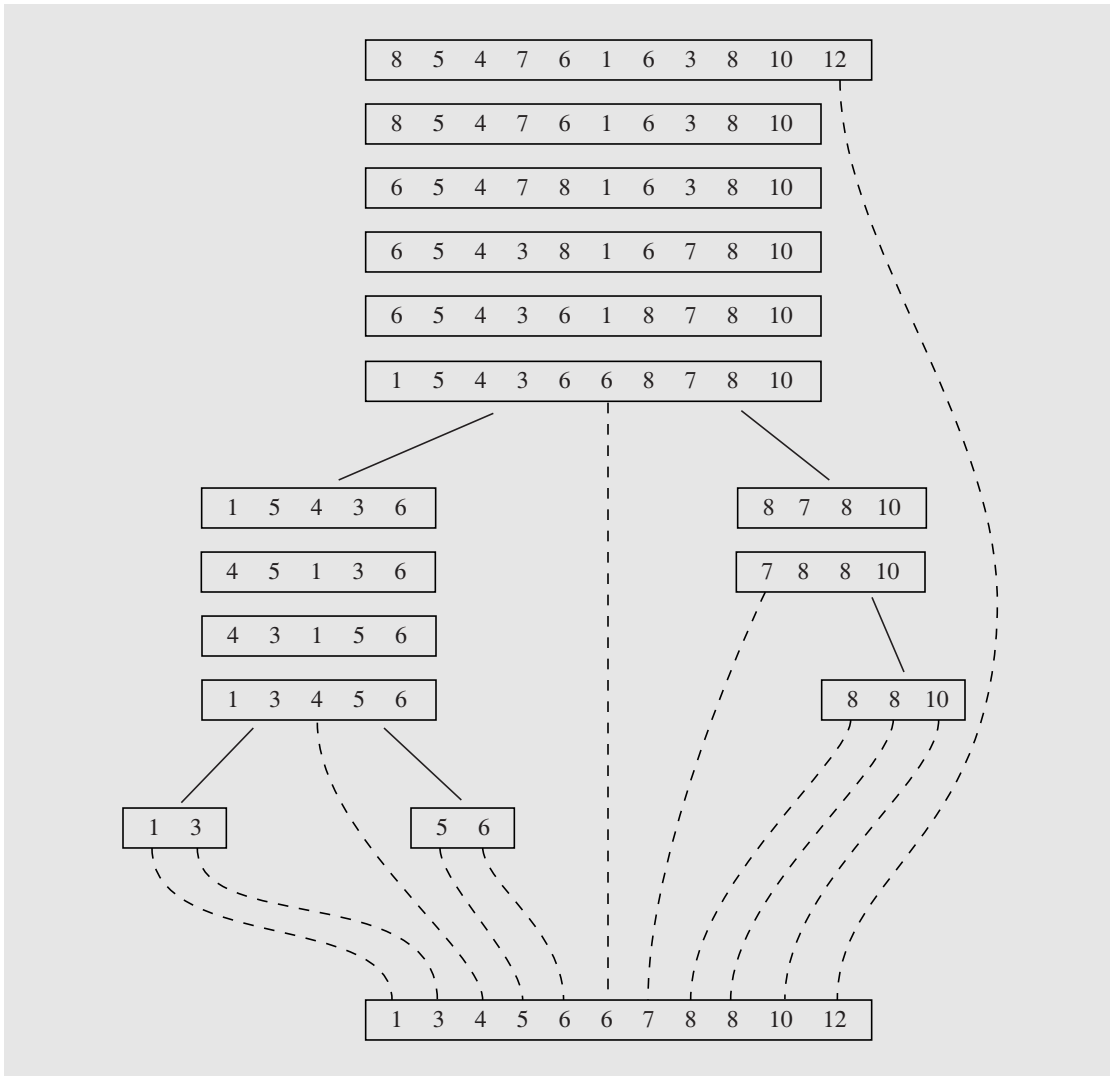
The best case is when the bound divides an array into two subarrays of approximately length  $\frac{n}{2}$ . If the bounds for both subarrays are well chosen, the partitions produce four new  $\frac{n}{2}$  subarrays, each of them with approximately  $\frac{n}{4}$  cells. If, again, the bounds for all four subarrays divide them evenly, the partitions give eight subarrays, each with approximately  $\frac{n}{8}$  elements. Therefore, the number of comparisons performed for all partitions is approximately equal to

$$n + 2\frac{n}{2} + 4\frac{n}{4} + 8\frac{n}{8} + \dots + n\frac{n}{n} = n(\lg n + 1)$$

which is  $O(n \lg n)$ . This is due to the fact that parameters in the terms of this sum (and also the denominators) form a geometric sequence so that  $n = 2^k$  for  $k = \lg n$  (assuming that  $n$  is a power of 2).

Now we can answer the question asked before: Is the average case, when the array is ordered randomly, closer to the best case,  $n \lg n$ , or to the worst,  $O(n^2)$ ? Some calcu-

**FIGURE 9.13** Sorting the array [8 5 4 7 6 1 6 3 8 10 12] with quicksort().



lations show that the average case requires only  $O(n \lg n)$  comparisons (see Appendix A.3), which is the desired result. The validity of this figure can be strengthened by referring to the tree obtained after disregarding the bottom rectangle in Figure 9.13. This tree indicates how important it is to keep the tree balanced, for the smaller the number of levels, the quicker the sorting process. In the extreme case, the tree can be turned into a linked list in which every nonleaf node has only one child. That rather rare phenomenon is possible and prevents us from calling quicksort the ideal sort. But quicksort seems to be closest to such an ideal because, as analytic studies indicate, it outperforms other efficient sorting methods by at least a factor of 2.

How can the worst case be avoided? The partition procedure should produce arrays of approximately the same size, which can be achieved if a good bound is chosen. This is the crux of the matter: How can the best bound be found? Only two methods will be mentioned. The first method randomly generates a number between `first` and `last`. This number is used as an index of the bound, which is then interchanged with the first element of the array. In this method, the partition process proceeds as before. Good random number generators may slow down the execution time as they themselves often use sophisticated and time-consuming techniques. Thus, this method is not highly recommended.

The second method chooses a median of three elements: the first, middle, and last. For the array [1 5 4 7 8 6 6 3 8 12 10], 6 is chosen from the set [1 6 10], and for the first generated subarray, the bound 4 is chosen from the set [1 4 6]. Obviously, there is the possibility that all three elements are always the smallest (or the largest) in the array, but it does not seem very likely.

Is quicksort the best sorting algorithm? It certainly is—usually. It is not bullet-proof, however, and some problems have already been addressed in this section. First, everything hinges on which element of the file or array is chosen for the bound. Ideally, it should be the median element of the array. An algorithm to choose a bound should be flexible enough to handle all possible orderings of the data to be sorted. Because some cases always slip by these algorithms, from time to time quicksort can be expected to be anything but quick.

Second, it is inappropriate to use quicksort for small arrays. For arrays with fewer than 30 items, insertion sort is more efficient than quicksort (Cook and Kim, 1980). In this case the initial pseudocode can be changed to

```
quicksort2 (array[ ])
  if array.length > 30
    partition array into subarray1 and subarray2;
    quicksort2(subarray1);
    quicksort2(subarray2);
  else insertionsort(array);
```

and the implementations changed accordingly. However, the table in Figure 9.18 later in this chapter indicates that `quicksort2()` does appreciably improve the efficiency of `quicksort()`, particularly for arrays that are nearly sorted.

### 9.3.4 Mergesort

The problem with quicksort is that its complexity in the worst case is  $O(n^2)$  because it is difficult to control the partitioning process. Different methods of choosing a bound attempt to make the behavior of this process fairly regular; however, there is no guarantee that partitioning results in arrays of approximately the same size. Another strategy is to make partitioning as simple as possible and concentrate on merging the two sorted arrays. This strategy is characteristic of *mergesort*. It was one of the first sorting algorithms used on a computer and was developed by John von Neumann.

The key process in mergesort is merging sorted halves of an array into one sorted array. However, these halves have to be sorted first, which is accomplished by merging the already sorted halves of these halves. This process of dividing arrays into two



halves stops when the array has fewer than two elements. The algorithm is recursive in nature and can be summarized in the following pseudocode:

```
mergesort(data)
  if data have at least two elements
    mergesort(left half of data);
    mergesort(right half of data);
    merge(both halves into a sorted list);
```

Merging two subarrays into one is a relatively simple task, as indicated in this pseudocode:

```
merge(array1, array2, array3)
  i1, i2, i3 are properly initialized;
  while both array2 and array3 contain elements
    if array2[i2] < array3[i3]
      array1[i1++] = array2[i2++];
    else array1[i1++] = array3[i3++];
  load into array1 the remaining elements of either array2 or array3;
```

For example, if  $\text{array2} = [1\ 4\ 6\ 8\ 10]$  and  $\text{array3} = [2\ 3\ 5\ 22]$ , then the resulting  $\text{array1} = [1\ 2\ 3\ 4\ 5\ 6\ 8\ 10\ 22]$ .

The pseudocode for `merge()` suggests that `array1`, `array2`, and `array3` are physically separate entities. However, for the proper execution of `mergesort()`, `array1` is a concatenation of `array2` and `array3` so that `array1` before the execution of `merge()` is  $[1\ 4\ 6\ 8\ 10\ 2\ 3\ 5\ 22]$ . In this situation, `merge()` leads to erroneous results, because after the second iteration of the `while` loop, `array2` is  $[1\ 2\ 6\ 8\ 10]$  and `array1` is  $[1\ 2\ 6\ 8\ 10\ 2\ 3\ 5\ 22]$ . Therefore, a temporary array has to be used during the merging process. At the end of the merging process, the contents of this temporary array are transferred to `array1`. Because `array2` and `array3` are subarrays of `array1`, they do not need to be passed as parameters to `merge()`. Instead, indexes for the beginning and the end of `array1` are passed, because `array1` can be a part of another array. The new pseudocode is

```
merge (array1, first, last)
  mid = (first + last) / 2;
  i1 = 0;
  i2 = first;
  i3 = mid + 1;
  while both left and right subarrays of array1 contain elements
    if array1[i2] < array1[i3]
      temp[i1++] = array1[i2++];
    else temp[i1++] = array1[i3++];
  load into temp the remaining elements of array1;
  load to array1 the content of temp;
```

The entire `array1` is copied to `temp` and then `temp` is copied back to `array1`, so the number of movements in each execution of `merge()` is always the same and is equal to  $2 \cdot (\text{last} - \text{first} + 1)$ . The number of comparisons depends on the ordering in `array1`. If `array1` is in order or if the elements in the right half

precede the elements in the left half, the number of comparisons is  $(\text{first} + \text{last})/2$ . The worst case is when the last element of one half precedes only the last element of the other half, as in [1 6 10 12] and [5 9 11 13]. In this case, the number of comparisons is  $\text{last} - \text{first}$ . For an  $n$ -element array, the number of comparisons is  $n - 1$ .

The pseudocode for `mergesort()` is now

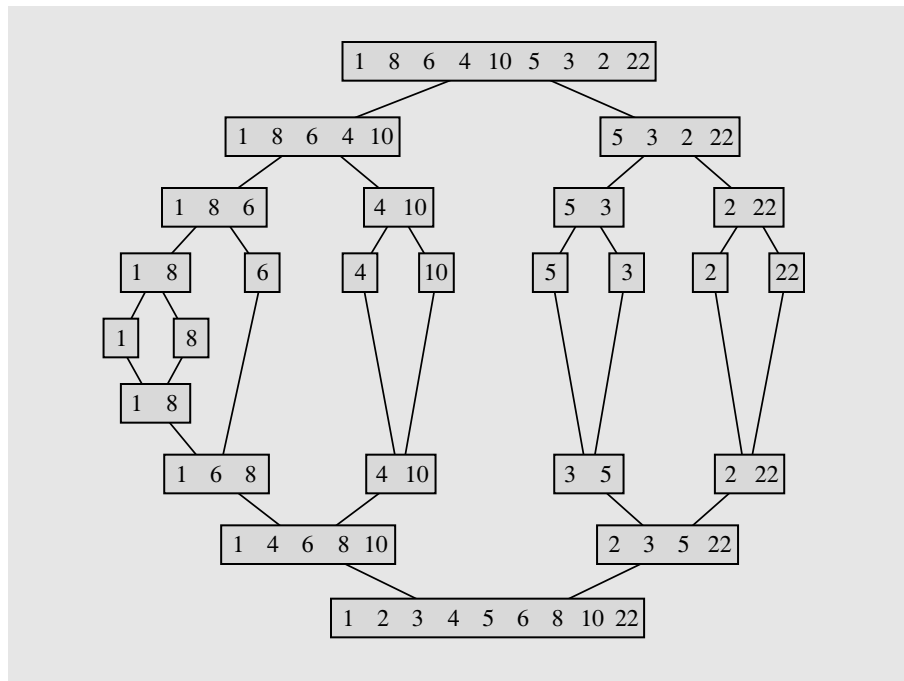
```
mergesort (data, first, last)
  if first < last
    mid = (first + last) / 2;
    mergesort(data, first, mid);
    mergesort(data, mid+1, last);
    merge(data, first, last);
```

Figure 9.14 illustrates an example using this sorting algorithm. This pseudocode can be used to analyze the computing time for mergesort. For an  $n$ -element array, the number of movements is computed by the following recurrence relation:

$$M(1) = 0$$

$$M(n) = 2M\left(\frac{n}{2}\right) + 2n$$

**FIGURE 9.14** The array [1 8 6 4 10 5 3 2 22] sorted by mergesort.



$M(n)$  can be computed in the following way:

$$\begin{aligned} M(n) &= 2\left(2M\left(\frac{n}{4}\right) + 2\left(\frac{n}{2}\right)\right) + 2n = 4M\left(\frac{n}{4}\right) + 4n \\ &= 4\left(2M\left(\frac{n}{8}\right) + 2\left(\frac{n}{4}\right)\right) + 4n = 8M\left(\frac{n}{8}\right) + 6n \\ &\vdots \\ &= 2^i M\left(\frac{n}{2^i}\right) + 2in \end{aligned}$$

Choosing  $i = \lg n$  so that  $n = 2^i$  allows us to infer

$$M(n) = 2^i M\left(\frac{n}{2^i}\right) + 2in = nM(1) + 2n \lg n = 2n \lg n = O(n \lg n)$$

The number of comparisons in the worst case is given by a similar relation:

$$\begin{aligned} C(1) &= 0 \\ C(n) &= 2C\left(\frac{n}{2}\right) + n - 1 \end{aligned}$$

which also results in  $C(n)$  being  $O(n \lg n)$ .

Mergesort can be made more efficient by replacing recursion with iteration (see the exercises at the end of this chapter) or by applying insertion sort to small portions of an array, a technique that was suggested for quicksort. However, mergesort has one serious drawback: the need for additional storage for merging arrays, which for large amounts of data could be an insurmountable obstacle.

### 9.3.5 Radix Sort

*Radix sort* is a popular way of sorting used in everyday life. To sort library cards, we may create as many piles of cards as letters in the alphabet, each pile containing authors whose names start with the same letter. Then, each pile is sorted separately using the same method; namely, piles are created according to the second letter of the authors' names. This process continues until the number of times the piles are divided into smaller piles equals the number of letters of the longest name. This method is actually used when sorting mail in the post office, and it was used to sort 80-column cards of coding information in the early days of computers.

When sorting library cards, we proceed from left to right. This method can also be used for sorting mail because all ZIP codes have the same length. However, it may be inconvenient for sorting lists of integers because they may have an unequal number of digits. If applied, this method would sort the list [23 123 234 567 3] into the list [123 23 234 3 567]. To get around this problem, zeros can be added in front of each number to make them of equal length so that the list [023 123 234 567 003] is sorted into the list [003 023 123 234 567]. Another technique looks at each number as a string of bits so that all integers are of equal length. This approach will be discussed shortly. Still another way to sort integers is by proceeding right to left, and this method is discussed now.

When sorting integers, 10 piles numbered 0 through 9 are created, and initially, integers are put in a given pile according to their rightmost digit so that 93 is put in pile 3. Then, piles are combined and the process is repeated, this time with the second rightmost digit; in this case, 93 ends up on pile 9. The process ends after the leftmost digit of the longest number is processed. The algorithm can be summarized in the following pseudocode:

```
radixsort()
  for d = 1 to the position of the leftmost digit of longest number
    distribute all numbers among piles 0 through 9 according to the dth digit;
    put all integers on one list;
```

The key to obtaining a proper outcome is the way the 10 piles are implemented and then combined. For example, if these piles are implemented as stacks, then the integers 93, 63, 64, 94 are put on piles 3 and 4 (other piles being empty):

```
pile 3: 63 93
pile 4: 94 64
```

These piles are then combined into the list 63, 93, 94, 64. When sorting them according to the second rightmost digit, the piles are as follows:

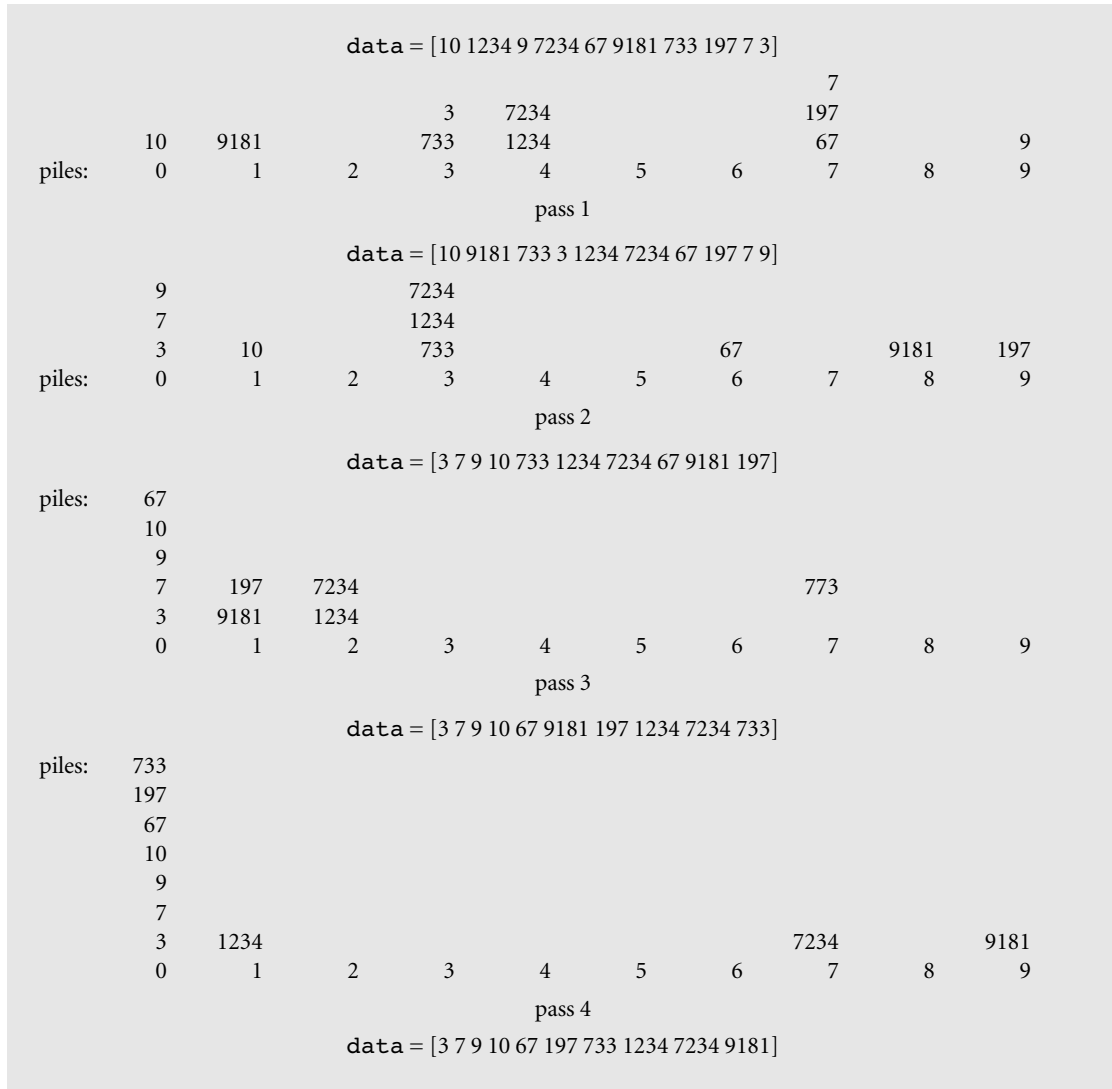
```
pile 6: 64 63
pile 9: 94 93
```

and the resulting list is 64, 63, 94, 93. The processing is finished, but the result is an improperly sorted list.

However, if piles are organized as queues, the relative order of elements on the list is retained. When integers are sorted according to the digit in position  $d$ , then within each pile, integers are sorted with regard to the part of the integer extending from digit 1 to  $d - 1$ . For example, if after the third pass, pile 5 contains the integers 12534, 554, 3590, then this pile is ordered with respect to the two rightmost digits of each number. Figure 9.15 illustrates another example of radix sort.

An implementation of radix sort follows. The implementation is a part of class `Sorts` in which integer `radix` is assigned number 10 and integer `digits` is also assigned 10 (the maximum number of digits for an integer).

```
void radixsort(int[] data) {
    int d, j, k, factor;
    Queue[] queues = new Queue[radix];
    for (d = 0; d < radix; d++)
        queues[d] = new Queue();
    for (d = 1, factor = 1; d <= digits; factor *= radix, d++) {
        for (j = 0; j < data.length; j++)
            queues[(data[j] / factor) % radix].enqueue(
                new Integer(data[j]));
        for (j = k = 0; j < radix; j++)
            while (!queues[j].isEmpty())
                data[k++] =
                    ((Integer) queues[j].dequeue()).intValue();
    }
}
```

**FIGURE 9.15** Sorting the list 10, 1234, 9, 7234, 67, 9181, 733, 197, 7, 3 with radix sort.

This algorithm does not rely on data comparison as did the previous sorting methods. For each integer from `data`, two operations are performed: division by a `factor` to disregard digits following digit  $i$  being processed in the current pass and division modulo `radix` (equal to 10) to disregard all digits preceding  $i$  for a total of  $2ndigits = O(n)$  operations. The operation `div` can be used, which combines both `/` and `%`. In each pass, all integers are moved to piles and then back to `data` for a total of  $2ndigits = O(n)$  moves. The algorithm requires additional space for piles, which

if implemented as linked lists, is equal to  $4n$  bytes for reference fields. Our implementation uses only `for` loops with counters; therefore, it requires the same amount of passes for each case: best, average, and worst. The body of the only `while` loop is always executed  $n$  times to dequeue integers from all queues.

The foregoing discussion treated integers as combinations of digits. But as already mentioned, they can be regarded as combinations of bits. This time, division and division modulo are not appropriate, because for each pass, one bit for each number has to be extracted. In this case, only two queues are required.

An implementation can be given as follows:

```
void bitRadixsort(int[] data) {
    int d, j, k, factor, mask = 1;
    Queue[] queues = new Queue[2];
    queues[0] = new Queue();
    queues[1] = new Queue();
    for (d = 1; d <= bits; d++) {
        for (j = 0; j < data.length; j++)
            queues[(data[j] & mask) == 0 ? 0 : 1].enqueue(
                new Integer(data[j]));

        mask <<= 1;
        k = 0;
        while (!queues[0].isEmpty())
            data[k++] = ((Integer)queues[0].dequeue()).intValue();
        while (!queues[1].isEmpty())
            data[k++] = ((Integer)queues[1].dequeue()).intValue();
        k = 0;
    }
}
```

Division is replaced here by the bitwise-and operation `&`. The variable `mask` has one bit set to 1 and the rest are set to 0. After each iteration, this 1 is shifted to the left. If `data[j] & mask` has a nonzero value, then `data[j]` is put in `queues[1]`; otherwise, it is put in `queues[0]`. Bitwise and is much faster than integer division, but this time 31 passes are needed; before it was only 10 (31 passes because only positive integers can be meaningfully processed with radix sort). This means  $31n$  data movements as opposed to  $10n$ , and quicker operations cannot outweigh a larger number of moves: `bitRadixsort()` is slower, much slower, than `radixsort()`.

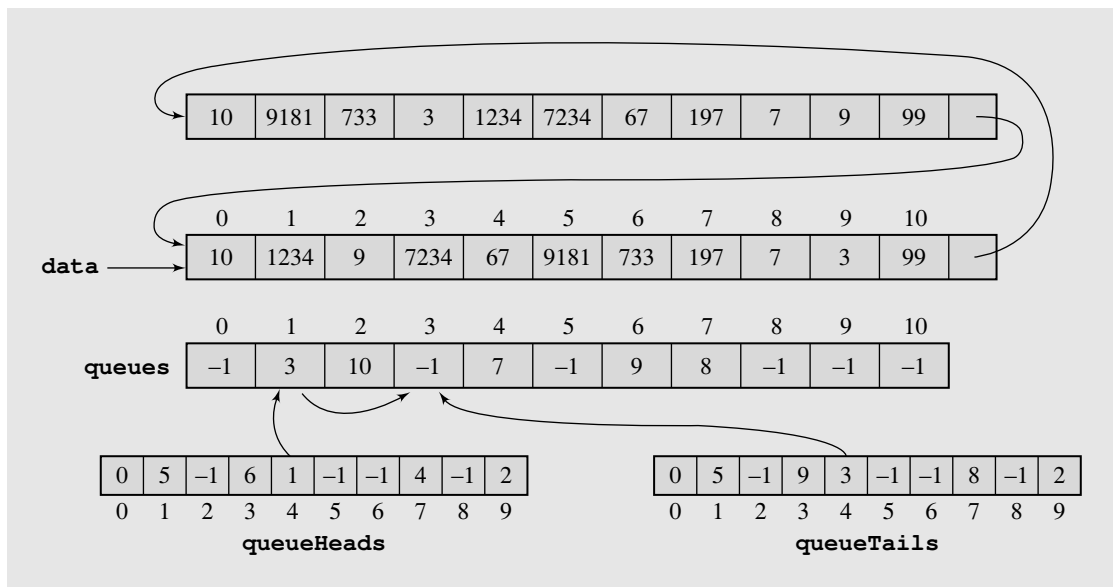
The problem is caused by the implementation of queues. They are implemented as linked lists, and for each item included in a particular queue, a new node has to be created and attached to the queue, and for each item copied back to the `data`, the node has to be detached from the queue. Although theoretically obtained performance  $O(n)$  is truly impressive, it does not include operations on queues, although overall efficiency hinges upon the efficiency of queue implementation.

A better implementation is an array of size  $n$  for each queue, which requires creating these queues only once. The efficiency of the algorithm depends only on the number of exchanges (copying to and from queues). However, if radix  $r$  is a large

number and a large amount of data has to be sorted, then this solution requires  $r$  queues of size  $n$ , and the number  $(r + 1) \cdot n$  (original array included) may be unrealistically large.

A better solution uses one integer array `queues` of size  $n$  representing linked lists of indexes of numbers belonging to particular queues. Cell  $i$  of the array `queueHeads` contains an index of the first number in `data` that belongs to this queue, whose  $d$ th digit is  $i$ . `queueTails[]` contains a position in `data` of the last number whose  $d$ th digit is  $i$ . Figure 9.16 illustrates the situation after the first pass, for  $d = 1$ . `queueHeads[4]` is 1, which means that the number in position 1 in `data`, 1234, is the first number found in `data` with 4 as the last digit. Cell `queues[1]` contains 3, which is an index of the next number in `data` with 4 as the last digit, 7234. Finally, `queues[3]` is  $-1$  to indicate the end of the numbers meeting this condition.

**FIGURE 9.16** An implementation of radix sort.



The next stage orders `data` according to information gathered in `queues`. It copies all the data from the original array to some temporary storage and then back to this array. To avoid the second copy, two arrays can be used, constituting a two-element circular linked list. After copying, the reference to the list is moved to the next node, and the array in this node is treated as storage of numbers to be sorted. The improvement is significant because the new implementation runs at least three times faster than the implementation that uses `queues` (see Figure 9.18 later in this chapter).

## 9.4 SORTING IN `java.util`

Java provides two sets of versions of sorting methods: one for arrays and one for lists.

The first set of sorting methods is given in the utility class `Arrays`. The class `Arrays` includes methods for processing arrays, in particular, methods for searching arrays for elements with binary search, methods for filling arrays with a particular value, a method for converting an array into a list, and sorting methods. All the sorting methods in `Arrays` implement a version of the quicksort algorithm. The sorting methods are provided for arrays with elements of all elementary types except `Boolean`. For each type, there are two versions, one for sorting an entire array and one for sorting a subarray. For example, for integer arrays there are two sorting methods:

```
public static void sort(int[] a);
public static void sort(int[] a, int first, int last);
```

An example of sorting an integer array, integer subarray, and a character array is given in Figure 9.17. The class `Arrays` also includes four generic sorting methods:

```
public static void sort(Object[] a);
public static void sort(Object[] a, int first, int last);
public static void sort(Object[] a, Comparator c);
public static void sort(Object[] a, int first, int last, Comparator c);
```

Quicksort implemented in `Arrays`' sorting methods is based on comparison of elements. For basic data types, the comparison is obvious, but for objects, a comparison criterion must be provided by the user (except for wrapper classes). For example, if an array consists of objects of type `Person` that includes two fields, a string field and an integer field, it is not obvious what it means that one `Person` object is less than another. For this reason, the class definition should implement the `compareTo()` method whose signature is included in the interface `java.lang.Comparable`. For example, class `Person` is defined as (Figure 9.17)

```
class Person implements Comparable { . . . }
```

There are two possible problems. First, there may be null objects present in an array, in which case the program crashes because `compareTo()` would be searched for in the null objects, as in

```
null.compareTo(someObject);
```

To prevent this from happening, a two-argument comparison method should be used, as in

```
compare(null, someObject);
```

Second, the user may want to apply another comparison criterion so that, for example, the `Person` objects can be ordered not by name but by age. One solution was proposed in Section 7.1.8 by defining two classes with their own versions of



**FIGURE 9.17** Demonstration of sorting functions.

```

import java.io.*;
import java.util.*;

class Person implements Comparable {
    private String name;
    public int age;
    public Person(String s, int i) {
        name = s; age = i;
    }
    public Person() {
        this("",0);
    }
    public String toString() {
        return "(" + name + ", " + age + ")";
    }
    public int compareTo(Object p) {
        return name.compareTo(((Person)p).name);
    }
}

class PersonComparator implements Comparator {
    public int compare(Object ob1, Object ob2) {
        if (ob1 == ob2)
            return 0;
        else if (ob1 == null)
            return -1;
        else if (ob2 == null)
            return 1;
        return ((Person)ob1).age - ((Person)ob2).age;
    }
}

class testSorts {
    public static void main(String[] ar) {
        int[] intArr1 = {4, 6, 7, 4, 2};
        int[] intArr2 = {4, 6, 7, 4, 2};
        char[] charArr = {'a', 'n', 'd', 'v', 'a'};
        Arrays.sort(intArr1); // intArr1 = [2, 4, 4, 6, 7]
        for (int i = 0; i < intArr1.length; i++)
            System.out.print(intArr1[i] + " ");
        System.out.println();
    }
}

```

*Continues*

**FIGURE 9.17** (continued)

```

Arrays.sort(intArr2,1,intArr2.length-2); // intArr2 = [4, 6, 7, 4, 2]
Arrays.sort(charArr); // charArr = ['a', 'a', 'd', 'n', 'v']
Person[] persons1 = {new Person("Tom",50), new Person("Lili",29),
                    new Person("Jeff",44)};
Person[] persons2 = {new Person("Tom",50), new Person("Lili",29),
                    new Person("Jeff",44), null};
Vector personVector = new Vector();
LinkedList personLList1 = new LinkedList();
LinkedList personLList2 = new LinkedList();
ArrayList personAList = new ArrayList();
for (int i = 0; i < persons1.length; i++) {
    personVector.add(persons1[i]);
    personLList1.add(persons1[i]);
    personLList2.add(persons1[i]);
    personAList.add(persons1[i]);
}
Collections.sort(personVector);
System.out.println("personVector = " + personVector);
// personVector = [(Jeff, 44), (Lili, 29), (Tom, 50)]
Collections.sort(personLList1);
// personLList1 = [(Jeff, 44), (Lili, 29), (Tom, 50)]
Collections.sort(personLList2,new PersonComparator());
// personLList2 = [(Lili, 29), (Jeff, 44), (Tom, 50)]
Collections.sort(personAList);
// personAList = [(Jeff, 44), (Lili, 29), (Tom, 50)]
Arrays.sort(persons1);
// persons1 = [(Jeff, 44), (Lili, 29), (Tom, 50)]
Arrays.sort(persons2,new PersonComparator());
// persons2 = [null, (Lili, 29), (Jeff, 44), (Tom, 50)]

Integer[] a = {new Integer(1), new Integer(4),
              new Integer(2), new Integer(5)};
(new Sorts()).insertionsort(a); // a = [1, 2, 4, 5]
Person[] persons3 = {new Person("Tom",50), new Person("Lili",29),
                    new Person("Jeff",44)};
(new Sorts()).insertionsort(persons3);
// persons3 = [(Lili, 29), (Jeff, 44), (Tom, 50)]
}
}

```

`compareTo()`. But this still does not solve the problem of null objects. The solution is in defining a comparator for a particular class by extending the interface `java.util.Comparator`, which includes a signature of the method `compare()`. An example of a `PersonComparator` is given in Figure 9.17. To apply a comparator, a sorting method has to be given an instance of the comparator to use the `compare()` method in sorting an array. If a comparator is not provided, the sorting method uses the `compareTo()` method.

Another set of sorting methods is included in the class `java.util.Collections` and consists of two methods:

```
public static void sort(List lst);
public static void sort(List lst, Comparator comp);
```

The two sorting methods implement mergesort and can be applied to vectors, array lists, and linked lists. Some examples are given in Figure 9.17. The figure also demonstrates an application of `insertionsort()`, discussed in Section 9.1.1, to an array of `Integer` objects and `Person` objects.

## 9.5

## CONCLUDING REMARKS

Figure 9.18 compares the run times for different sorting algorithms and different numbers of integers being sorted. They were all run on a PC. At each stage, the number of integers has been doubled to see the factors by which the run times raise. These factors are included in each column except for the first three columns, and are shown along with the run times. The factors are rounded to one decimal place, whereas run times (in seconds) are rounded to two decimal places. For example, heap sort requires .38 sec to sort an array of 10,000 `Integer` objects in ascending order, and .72 sec to sort 20,000 `Integer` objects, also in ascending order. Doubling the amount of data is associated with the increase of run time by a factor of  $.72/.38 = 1.8947 \approx 1.9$ , and the number 1.9 follows .72 in the fifth column.

Figure 9.18 indicates that the run time for elementary sorting methods, which are squared algorithms, grows approximately by a factor of 4 after the amount of data is doubled, whereas the same factor for nonelementary methods, whose complexity is  $O(n \lg n)$  is approximately 2. This is also true for the four implementations of radix sort, whose complexity equals  $2n\text{digits}$  or  $2n\text{bits}$ . The table also shows that quicksort is the fastest algorithm among all sorting methods; most of the time, it runs at least twice as fast as any other algorithm.

It is important, however, that if possible, wrapper types should be avoided in sorting, and basic cases should be used instead to increase efficiency of the sorting routine. Figure 9.18 indicates times for sorting routines applied to arrays of `Integer` objects. Sorting arrays of integers is approximately 15 times faster.

**FIGURE 9.18** Comparison of run times for different sorting algorithms and different numbers of integers to be sorted.

	10,000			20,000		
	Ascending	Random	Descending	Ascending	Random	Descending
insertionsort	.05	15.82	26.92	.06 1.2	1 m 14.83 4.7	1 m 40.57 3.7
selectionsort	46.86	51.46	59.91	3 m 13.5 4.1	3 m 44.92 4.4	3 m 23.56 4.0
bubblesort	43.06	1 m 11.24	1 m 13.05	2 m 58.51 4.1	4 m 47.81 4.0	5 m 3.90 4.2
Shellsort	.11	.22	.11	.22 2.0	.49 2.2	.33 3.0
heapsort	.38	.39	.28	.72 1.9	.88 2.3	.72 2.8
mergesort	.27	.33	.22	.50 1.8	.66 2.0	.49 2.2
quicksort	.11	.17	.11	.16 1.5	.44 2.6	.22 2.0
quicksort2	.06	.16	.11	.11 1.8	.38 2.4	.16 1.5
radixsort	1.20	1.05	1.16	2.31 1.9	1.59 1.5	2.20 1.9
bitRadixsort	2.97	1.92	2.47	6.54 2.2	4.50 2.7	5.65 2.3
radixsort2	.11	.11	.11	.21 1.9	.28 2.0	.22 2.0
bitRadixsort2	.33	.17	.27	.14 1.3	.44 2.2	.44 1.6
	40,000			80,000		
	Ascending	Random	Descending	Ascending	Random	Descending
insertionsort	.11 18	6 m 8.93 5.0	7 m 11.82 4.3	.11 1.0	29 m 2.73 4.7	29 m 36.13 4.2
selectionsort	14 m 8.11 4.4	16 m 12.23 4.3	13 m 31.52 4.0	56 m 8.09 4.0	67 m 21.31 4.2	56 m 49.94 4.2
bubblesort	12 m 58.95 4.4	20 m 53.62 4.4	20 m 17.92 4.0	52 m 6.90 4.0	87 m 9.62 4.2	83 m 6.68 4.1
Shellsort	.60 2.7	1.15 2.3	.72 2.2	1.32 2.2	2.75 2.4	1.59 2.2
heapsort	2.63 2.2	2.03 2.3	1.59 2.2	3.63 2.3	4.56 2.2	3.35 2.1
mergesort	1.59 2.2	1.48 2.2	.99 2.0	2.19 2.1	3.35 2.3	2.20 2.2
quicksort	.44 2.7	93 2.1	.44 2.0	.93 2.1	2.04 2.2	.99 2.3
quicksort2	.33 3.0	.88 2.3	.33 2.0	.77 2.3	1.92 2.2	.82 2.2
radixsort	5.22 2.3	4.51 2.8	5.60 2.6	10.98 2.1	10.82 2.4	10.00 1.8
bitRadixsort	9.94 1.5	11.31 2.2	17.68 3.1	28.40 2.9	31.04 2.7	29.00 1.6
radixsort2	.55 2.6	.61 2.2	.55 2.5	1.16 2.1	1.26 2.1	1.15 2.1
bitRadixsort2	.93 2.1	1.15 1.3	.88 2.0	1.83 2.0	2.42 2.1	1.98 2.3

## 9.6 CASE STUDY: ADDING POLYNOMIALS

Adding polynomials is a common algebraic operation and is usually a simple calculation. It is a known rule that, to add two terms, they must contain the same variables raised to the same powers, and the resulting term retains these variables and powers, except that its coefficient is computed by simply adding coefficients of both terms. For example,

$$3x^2y^3 + 5x^2y^3 = 8x^2y^3$$

but  $3x^2y^3$  and  $5x^2z^3$  or  $3x^2y^3$  and  $5x^2y^2$  cannot be conveniently added because the first pair of terms has different variables, and the variables in the second pair are raised to different powers. We would like to write a program that computes the sum of two polynomials entered by the user. For example, if

$$3x^2y^3 + 5x^2w^3 - 8x^2w^3z^4 + 3$$

and

$$-2x^2w^3 + 9y - 4xw - x^2y^3 + 8x^2w^3z^4 - 4$$

are entered, the program should output

$$-4wx + 3w^3x^2 + 2x^2y^3 + 9y - 1$$

To be more exact, the input and output for this problem should be as follows:

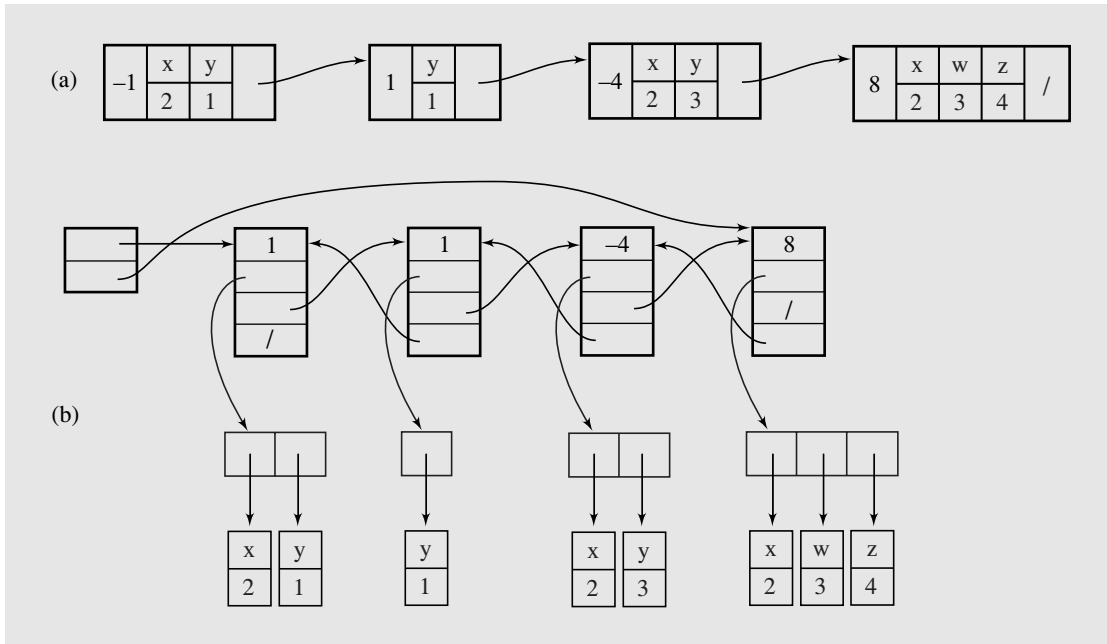
```
Enter two polynomials ended with a semicolon:
3x2y3 + 5x2w3 - 8x2w3z4 + 3;
- 2x2w3 + 9y - 4xw - x2y3 + 8x2w3z4 - 4;
The result is:
- 4wx + 3w3x2 + 2x2y3 + 9y - 1
```

It has to be observed that the order of variables in a term is irrelevant; for example,  $x^2y^3$  and  $y^3x^2$  represent exactly the same term. Therefore, before any addition is performed, the program should order all of the variables in each term to make the terms homogeneous and add them properly. Thus, there are two major tasks to be implemented: ordering variables in each term of both polynomials and adding the polynomials. But before we embark on the problem of implementing the algorithms, we have to decide how to represent polynomials in Java. Out of many possibilities, a linked list representation is chosen with each node on the list representing one term. A term contains information about a coefficient, variables, and exponents included in the term. Because each variable and its exponent belong together, they are also kept together in an object of type `Variable`. Also, because the number of variables can vary from one term to another, an array list of the `Variable` objects is used to store in one node information concerning variables in one term. A polynomial is simply a linked list of such nodes. For example,

$$-x^2y + y - 4x^2y^3 + 8x^2w^3z^4$$

is represented by the list in Figure 9.19a, which in Java looks like the list in Figure 9.19b.

The first operation to perform on these polynomials is to order variables in their terms. After a polynomial is entered, each term is sorted separately by sorting array lists accessible from the nodes of the list.

**FIGURE 9.19** A linked list representation of the expression  $-x^2y + y - 4x^2y^3 + 8x^2w^3z^4$ .

The second task is to add the polynomials. The process begins by creating a linked list consisting of copies of nodes of the polynomials to be added. In this way, the two polynomials are not affected and can be used in other operations.

Now, addition is reduced to simplification. In the linked list, all equal terms (equal except for the coefficients) have to be collapsed together, and redundant nodes must be eliminated. For example, if the list being processed is as in Figure 9.20a, then the resulting list in Figure 9.20b results from the simplification operation.

When printing the result, remember that not everything should be printed. If the coefficient is zero, a term is omitted. If it is one or minus one, the term is printed, but the coefficient is not included (except for the sign), unless the term has just a coefficient. If an exponent is one, it is also omitted.

Another printing challenge is ordering terms in a polynomial—that is, converting a somewhat disorganized polynomial

$$-z^2 - 2w^2x^3 + 5 + 9y - 5z - 4wx - x^2y^3 + 3w^2x^3z^4 + 10yz$$

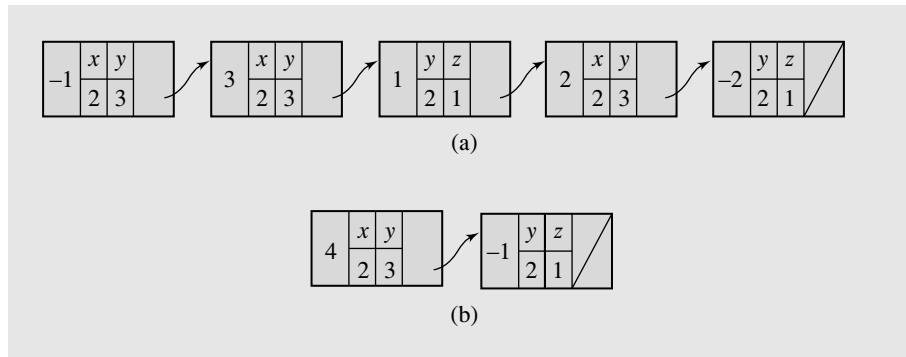
into the tidier form

$$-4wx - 2w^2x^3 + 3w^2x^3z^4 - x^2y^3 + 9y + 10yz - 5z - z^2 + 5$$

To accomplish this, the linked list representing a polynomial has to be sorted.

Figure 9.21 contains the complete code for the program to add polynomials.

**FIGURE 9.20** Transforming (a) a list representing the expression  $-x^2y^3 + 3x^2y^3 + y^2z + 2x^2y^3 - 2y^2z$  into (b) a list representing a simplified version of this expression,  $4x^2y^3 - y^2z$ .



**FIGURE 9.21** Implementation of the program to add polynomials.

```
import java.io.*;
import java.util.*;

class Variable implements Comparable, Cloneable {
    public char id;
    public int exp;
    public Variable() {
    }
    public Variable(char c, int i) {
        id = c; exp = i;
    }
    public int compareTo(Object v) {
        return id - ((Variable)v).id;
    }
    public boolean equals(Object v) {
        return id == ((Variable)v).id && exp == ((Variable)v).exp;
    }
    public Object clone() {
        return new Variable(id,exp);
    }
}

class Term implements Comparable, Cloneable {
    public Term() {
    }
}
```

*Continues*

**FIGURE 9.21** (continued)

```

public int coeff;
public ArrayList vars = new ArrayList();
public Object clone() {
    Term t = new Term();
    t.coeff = coeff;
    t.vars = (ArrayList) vars.clone();
    for (int i = 0; i < vars.size(); i++)
        t.vars.set(i, ((Variable)vars.get(i)).clone());
    return t;
}
/** two terms are equal if all variables are the same and
 * corresponding variables are raised to the same power;
 * the first cell of the node containing a term is excluded
 * from comparison, since it stores coefficient of the term;
 */
public boolean equals(Object term) {
    int i;
    for (i = 0; i < Math.min(vars.size(), ((Term)term).vars.size()) &&
        vars.get(i).equals(((Term)term).vars.get(i)); i++);
    return i == vars.size() && vars.size() == ((Term)term).vars.size();
}
public int compareTo(Object term2) {
    if (vars.size() == 0)
        return 1; // this is just a coefficient;
    else if (((Term)term2).vars.size() == 0)
        return -1; // term2 is just a coefficient;
    Variable var1, var2;
    for (int i = 0; i < Math.min(vars.size(), ((Term)term2).vars.size()); i++) {
        var1 = (Variable)vars.get(i);
        var2 = (Variable)((Term)term2).vars.get(i);
        if (var1.id < var2.id)
            return -1; // this precedes term2;
        else if (var2.id < var1.id)
            return 1; // term2 precedes this;
        else if (var1.exp < var2.exp)
            return -1; // this precedes term2;
        else if (var2.exp < var1.exp)
            return 1; // term2 precedes this;
    }
    return vars.size() - ((Term)term2).vars.size();
}
}

```



**FIGURE 9.21** (continued)

```

class Polynomial {
    private LinkedList terms = new LinkedList();
    public Polynomial() {
    }
    private void error(String s) {
        System.out.println(s);
        Runtime.getRuntime().exit(-1);
    }
    public Polynomial add(Polynomial polyn2) {
        ListIterator p1, p2;
        Polynomial result = new Polynomial();
        int i;
        for (p1 = terms.listIterator(); p1.hasNext(); ) // create new polynomial
            result.terms.add(((Term)p1.next()).clone()); // out of copies
        for (p2 = polyn2.terms.listIterator(); p2.hasNext(); ) // of this
            result.terms.add(((Term)p2.next()).clone()); // polynomial and polyn2;
        for (i = 0, p1 = result.terms.listIterator(); p1.hasNext();
            i++, p1 = result.terms.listIterator(i)) {
            Term term1 = (Term) p1.next();
            for (p2 = p1; p2.hasNext(); ) {
                Term term2 = (Term) p2.next();
                if (term1.equals(term2)) {
                    term2.coeff += term1.coeff;
                    result.terms.remove(term1);
                    if (term2.coeff == 0) // remove terms with zero
                        result.terms.remove(term2); // coefficients;
                    i = -1; // to become i = 0 after autoincrement;
                    break;
                }
            }
        }
        Collections.sort(result.terms);
        return result;
    }
    public void get(InputStream fIn) {
        int ch = ' ', i, sign, exp;
        boolean coeffUsed;
        char id;
        Term term = new Term();

```

*Continues*

**FIGURE 9.21** (continued)

```

try {
    while (ch > -1) {
        coeffUsed = false;
        while (true)
            if (ch > -1 && Character.isWhitespace((char)ch)) // skip
                ch = fIn.read(); // blanks;
            else break;
        if (!Character.isLetterOrDigit((char)ch) &&
            ch != ';' && ch != '-' && ch != '+')
            error("Wrong character entered2");
        if (ch == -1)
            break;
        sign = 1;
        while (ch == '-' || ch == '+') { // first get sign(s) of Term
            if (ch == '-')
                sign *= -1;
            ch = fIn.read();
            while (Character.isWhitespace((char)ch))
                ch = fIn.read();
        }
        if (Character.isDigit((char)ch)) { // and then its coefficient;
            String number = "";
            while (Character.isDigit((char)ch)) {
                number += (char) ch;
                ch = fIn.read();
            }
            while (Character.isWhitespace((char)ch))
                ch = fIn.read();
            term.coeff = sign * Integer.valueOf(number).intValue();
            coeffUsed = true;
        }
        else term.coeff = sign;
        for (i = 0; Character.isLetterOrDigit((char)ch); i++) {
            id = (char) ch; // process this term:
            ch = fIn.read(); // get a variable name
            if (Character.isDigit((char)ch)) { // and an exponent
                String number = ""; // (if any);
                while (Character.isDigit((char)ch)) {
                    number += (char) ch;
                    ch = fIn.read();
                }
                exp = Integer.valueOf(number).intValue();
            }
        }
    }
}

```

**FIGURE 9.21** (continued)

```

        while (Character.isWhitespace((char)ch))
            ch = fIn.read();
    }
    else exp = 1;
    term.vars.add(new Variable(id,exp));
}
terms.add(term.clone());
term.vars = new ArrayList();
while (Character.isWhitespace((char)ch))
    ch = fIn.read();
if (ch == ';') // finish if a semicolon is entered;
    if (coeffUsed || i > 0)
        break;
    else error("Term is missing"); // e.g., 2x - ; or just ';'
else if (ch != '-' && ch != '+') // e.g., 2x 4y;
    error("wrong character entered");
}
} catch (IOException io) {
}
for (Iterator p = terms.iterator(); p.hasNext(); ) {
    term = (Term) p.next(); // order alphabetically variables
    if (term.vars.size() > 1) // in each term separately;
        Collections.sort(term.vars);
}
}
public void display() {
    boolean afterFirstTerm = false;
    for (Iterator it = terms.iterator(); it.hasNext(); ) {
        Term term = (Term) it.next();
        System.out.print(" ");
        if (term.coeff < 0) // put '-' before polynomial
            System.out.print("-"); // and between terms (if needed);
        else if (afterFirstTerm) // don't put '+' in front of
            System.out.print("+"); // polynomial;
        afterFirstTerm = true;
        System.out.print(" "); // print a coefficient if
        if (term.vars.size() == 0 || // the term has only
            Math.abs(term.coeff) != 1) // a coefficient or coefficient
            System.out.print(Math.abs(term.coeff)); // is not 1 or -1;
        for (int i = 1; i <= term.vars.size(); i++) {

```

*Continues*

**FIGURE 9.21** (continued)

```
        Variable var = (Variable) term.vars.get(i-1);
        System.out.print(var.id); // print a variable name
        if (var.exp != 1) // and an exponent, only
            System.out.print(var.exp); // if it is not 1.
    }
}
System.out.println();
}
}

class AddPolyn {
    static public void main(String[] a) {
        Polynomial polyn1 = new Polynomial(), polyn2 = new Polynomial();
        System.out.println("Enter two polynomials, each ended with a semicolon:");
        polyn1.get(System.in);
        polyn2.get(System.in);
        System.out.println("The result is:");
        polyn1.add(polyn2).display();
    }
}
```

## 9.7

## EXERCISES

1. Many operations can be performed faster on sorted than on unsorted data. For which of the following operations is this the case?
  - a. checking whether one word is an anagram of another word, e.g., *plum* and *lump*
  - b. finding an item with a minimum value
  - c. computing an average of values
  - d. finding the middle value (the median)
  - e. finding the value that appears most frequently in the data
2. The method `bubblesort()` is inefficient because it continues execution after an array is sorted by performing unnecessary comparisons. Therefore, the number of comparisons in the best and worst cases is the same. The implementation can be improved by making a provision for the case when the array is already sorted. Modify `bubblesort()` by adding a flag to the outer `for` loop indicating whether it is necessary to make the next pass. Set the flag to true every time an interchange occurs, which indicates that there is a need to scan the array again.
3. Will `bubblesort()` work properly if the inner loop
 

```
for (int j = n-1; j > i; --j)
```

 is replaced by
 

```
for (int j = n-1; j > 0; --j)
```

 What is the complexity of the new version?
4. In our implementation of bubble sort, a sorted array was scanned bottom-up to bubble up the smallest element. What modifications are needed to make it work top-down to bubble down the largest element?
5. A *cocktail shaker sort* designed by Donald Knuth is a modification of bubble sort in which the direction of bubbling changes in each iteration: In one iteration, the smallest element is bubbled up; in the next, the largest is bubbled down; in the next, the second smallest is bubbled up; and so forth. Implement this new algorithm and explore its complexity.
6. Insertion sort goes sequentially through the array when making comparisons to find a proper place for an element currently processed. Consider using binary search instead and give a complexity of the resulting insertion sort.
7. Draw decision trees for all the elementary sorting algorithms as applied to the array [a b c d].
8. Which of the algorithms discussed in this chapter is easily adaptable to singly linked lists? To doubly linked lists?
9. What exactly are the smallest and largest numbers of movements and comparisons to sort four elements using `ShellSort()`, `heapsort()`, `quicksort()`, and `mergesort()`?
10. Implement and test `mergesort()`.

11. Show that for mergesort the number of comparisons  $C(n) = n \lg n - 2^{\lg n} + 1$ .
12. Implement and analyze the complexity of the following nonrecursive version of mergesort. First, merge subarrays of length 1 into  $\frac{n}{2}$  two-cell subarrays, possibly one of them being a one-cell array. The resulting arrays are then merged into  $\frac{n}{4}$  four-cell subarrays possibly, with one smaller array, having one, two, or three cells, and so on, until the entire array is ordered. Note that this is a bottom-up approach to the mergesort implementation, as opposed to the top-down approach discussed in this chapter.
13. `mergesort()` merges the subarrays of an array that is already in order. Another top-down version of mergesort alleviates this problem by merging only *runs*, subarrays with ordered elements. Merging is applied only after two runs are determined. For example, in the array [6 7 8 3 4 10 11 12 13 2], runs [6 7 8] and [3 4] are first merged to become [3 4 6 7 8], then runs [10 11 12 13] and [2] are merged to become [2 10 11 12 13], and finally, runs [3 4 6 7 8] and [2 10 11 12 13] are merged to become [2 3 4 6 7 8 10 11 12 13]. Implement this algorithm and investigate its complexity. A mergesort that takes advantage of a partial ordering of data (that is, uses the runs) is called a *natural sort*. A version that disregards the runs by always dividing arrays into (almost) even sections is referred to as *straight merging*.
14. To avoid doubling the workspace needed when arrays are sorted with mergesort, it may be better to use a linked list of data instead of an array. In what situations is this approach better? Implement this technique and discuss its complexity.
15. A sorting algorithm is said to be *stable* if equal keys remain in the same relative order in the output as they are in the initial array; if  $a[i]$  equals  $a[j]$  for  $i < j$  and then the  $i$ th element ends up in the  $k$ th position, and the  $j$ th element in the  $m$ th position, then  $k < m$ . Which sorting algorithms are stable?
16. Consider a *slow sorting* algorithm, which applies selection sort to every  $i$ th element of an  $n$ -element array, where  $i$  takes on values  $n/2, n/3, \dots, n/n$  (Julstrom 1992). First, selection sort is applied to two elements of the array, the first and the middle elements, then to three elements, separated by the distance  $n/3$ , and so on, and finally to every element. Compute the complexity of this algorithm.

## 9.8

## PROGRAMMING ASSIGNMENTS

1. At the end of the section discussing quicksort, two techniques for choosing the bound were mentioned—using a randomly chosen element from the file and using a median element of the first, middle, and last elements of the array. Implement these two versions of quicksort, apply them to large arrays, and compare their run times.
2. Implement different versions of Shell sort by mixing simple sorts used in  $h$ -sorts, 1-sort, and different sequences of increments. Run each version with (at least) any of the following sequences:
  - a.  $h_1 = 1, h_{i+1} = 3h_i + 1$  and stop with  $h_i$  for which  $h_{i+2} \geq n$  (Knuth)
  - b.  $2^k - 1$  (Hibbard)

- c.  $2^k + 1$  (Papernov and Stasevich)
- d. Fibonacci numbers
- e.  $\frac{n}{2}$  is the first increment and then  $h_i = .75h_{i+1}$  (Dobosiewicz)

Run all these versions for at least five sets of data of sizes 1,000, 5,000, 10,000, 50,000, and 100,000. Tabulate and plot the results and try to approximate them with some formula expressing the complexity of these versions.

3. Extend the program from the case study to include polynomial multiplication.
4. Extend the program from the case study to include polynomial differentiation. For the rules, see the exercises in Chapter 5.

## BIBLIOGRAPHY

### *Sorting Algorithms*

Flores, Ivan, *Computer Sorting*, Englewood Cliffs, NJ: Prentice Hall, 1969.

Knuth, Donald E., *The Art of Computer Programming, Vol. 3: Sorting and Searching*, Reading, MA: Addison-Wesley, 1998.

Lorin, Harold, *Sorting and Sort Systems*, Reading, MA: Addison-Wesley, 1975.

McLuckie, Keith, and Barber, Angus, *Sorting Routines for Microcomputers*, Basingstoke, United Kingdom: Macmillan, 1986.

Mehlhorn, Kurt, *Data Structures and Algorithms, Vol. 1: Sorting and Searching*, Berlin: Springer, 1984.

Reynolds, Carl W., "Sorts of Sorts," *Computer Language* (March 1988), 49–62.

Rich, R., *Internal Sorting Methods Illustrated with PL/1 Programs*, Englewood Cliffs, NJ: Prentice Hall, 1972.

### *Shell Sort*

Dobosiewicz, W., "An Efficient Variation of Bubble Sort," *Information Processing Letters* 11 (1980), 5–6.

Gale, David, and Karp, Richard M., "A Phenomenon in the Theory of Sorting," *Journal of Computer and System Sciences* 6 (1972), 103–115.

Incerpi, Janet, and Sedgewick, Robert, "Practical Variations of Shellsort," *Information Processing Letters* 26 (1987/88), 37–43.

Poonen, Bjorn, "The Worst Case in Shellsort and Related Algorithms," *Journal of Algorithms* 15 (1993), 101–124.

Pratt, Vaughan R., *Shellsort and Sorting Networks*, New York: Garland, 1979.

Shell, Donald L., "A High-Speed Sorting Procedure," *Communications of the ACM* 2 (1959), 30–32.

Weiss, Mark A., and Sedgewick, Robert, "Tight Lower Bounds for Shellsort," *Journal of Algorithms* 11 (1990), 242–251.

**Heap Sort**

Carlsson, Svente, "Average-Case Results on Heapsort," *BIT* 27 (1987), 2–17.

Ding, Yuzheng, and Weiss, Mark A., "Best Case Lower Bounds for Heapsort," *Computing* 49 (1992), 1–9.

Wegener, Ingo, "Bottom-up-Heap Sort, A New Variant of Heap Sort Beating on Average Quick Sort," in Rovan, B. (ed.), *Mathematical Foundations of Computer Science*, Berlin: Springer, (1990), 516–522.

Williams, John W. J., "Algorithm 232: Heapsort," *Communications of the ACM* 7 (1964), 347–348.

**Quicksort**

Cook, Curtis R., and Kim, Do Jin, "Best Sorting Algorithm for Nearly Sorted Lists," *Communications of the ACM* 23 (1980), 620–624.

Dromey, R. G., "Exploiting Partial Order with Quicksort," *Software Practice and Experience* 14 (1984), 509–518.

Frazer, William D., and McKellar, Archie C., "Samplesort: A Sampling Approach to Minimal Storage Tree Sorting," *Journal of the ACM* 17 (1970), 496–507.

Hoare, Charles A. R., "Algorithm 63: Quicksort," *Communications of the ACM* 4 (1961), 321.

Hoare, Charles A. R., "Quicksort," *Computer Journal* 2 (1962), 10–15.

Huang, B. C., and Knuth, Donald, "A One-Way, Stackless Quicksort Algorithm," *BIT* 26 (1986), 127–130.

Motzkin, Dalia, "Meansort," *Communications of the ACM* 26 (1983), 250–251.

Sedgewick, Robert, *Quicksort*, New York: Garland, 1980.

**Mergesort**

Dvorak, S., and Durian, B., "Unstable Linear Time  $O(1)$  Space Merging," *The Computer Journal* 31 (1988), 279–283.

Huang, B. C., and Langston, M. A., "Practical In-Place Merging," *Communications of the ACM* 31 (1988), 348–352.

Knuth, Donald, "Von Neumann's First Computer Program," *Computing Surveys* 2 (1970), 247–260.

**Slow Sorting**

Julstrom, A., "Slow Sorting: A Whimsical Inquiry," *SIGCSE Bulletin* 24 (1992), No. 3, 11–13.

**Decision Trees**

Moret, B. M. E., "Decision Trees and Algorithms," *Computing Surveys* 14 (1982), 593–623.



# Hashing

# 10

The main operation used by the searching methods described in the preceding chapters was comparison of keys. In a sequential search, the table that stores the elements is searched successively, and the key comparison determines whether an element has been found. In a binary search, the table that stores the elements is divided successively into halves to determine which cell of the table to check, and again, the key comparison determines whether an element has been found. Similarly, the decision to continue the search in a binary search tree in a particular direction is accomplished by comparing keys.

A different approach to searching calculates the position of the key in the table based on the value of the key. The value of the key is the only indication of the position. When the key is known, the position in the table can be accessed directly, without making any other preliminary tests, as required in a binary search or when searching a tree. This means that the search time is reduced from  $O(n)$ , as in a sequential search, or from  $O(\lg n)$ , as in a binary search, to 1 or at least  $O(1)$ ; regardless of the number of elements being searched, the run time is always the same. But this is just an ideal, and in real applications, this ideal can only be approximated.

We need to find a function  $h$  that can transform a particular key  $K$ , be it a string, number, record, or the like, into an index in the table used for storing items of the same type as  $K$ . The function  $h$  is called a *hash function*. If  $h$  transforms different keys into different numbers, it is called a *perfect hash function*. To create a perfect hash function, which is always the goal, the table has to contain at least the same number of positions as the number of elements being hashed. But the number of elements is not always known ahead of time. For example, a compiler keeps all variables used in a program in a symbol table. Real programs use only a fraction of the vast number of possible variable names, so a table size of 1,000 cells is usually adequate.

But even if this table can accommodate all the variables in the program, how can we design a function  $h$  that allows the compiler to immediately access the position associated with each variable? All the letters of the variable name can be added together and the sum can be used as an index. In this case, the table needs 3,782 cells (for a

variable  $K$  made out of 31 letters “z,”  $h(K) = 31 \cdot 122 = 3,782$ ). But even with this size, the function  $h$  does not return unique values. For example,  $h(\text{“abc”}) = h(\text{“acb”})$ . This problem is called *collision*, and is discussed later. The worth of a hash function depends on how well it avoids collisions. Avoiding collisions can be achieved by making the function more sophisticated, but this sophistication should not go too far because the computational cost in determining  $h(K)$  can be prohibitive, and less sophisticated methods may be faster.

## 10.1 HASH FUNCTIONS

The number of hash functions that can be used to assign positions to  $n$  items in a table of  $m$  positions (for  $n \leq m$ ) is equal to  $m^n$ . The number of perfect hash functions is the same as the number of different placements of these items in the table and is equal to  $\frac{m!}{(m-n)!}$ . For example, for 50 elements and a 100-cell array, there are  $100^{50} = 10^{100}$  hash functions, out of which “only”  $10^{94}$  (one in a million) are perfect. Most of these functions are too unwieldy for practical applications and cannot be represented by a concise formula. However, even among functions that can be expressed with a formula, the number of possibilities is vast. This section discusses some specific types of hash functions.

### 10.1.1 Division

A hash function must guarantee that the number it returns is a valid index to one of the table cells. The simplest way to accomplish this is to use division modulo  $TSize = sizeof(table)$ , as in  $h(K) = K \bmod TSize$ , if  $K$  is a number. It is best if  $TSize$  is a prime number; otherwise,  $h(K) = (K \bmod p) \bmod TSize$  for some prime  $p > TSize$  can be used. However, nonprime divisors may work equally well as prime divisors provided they do not have prime factors less than 20 (Lum et al., 1971). The division method is usually the preferred choice for the hash function if very little is known about the keys.

### 10.1.2 Folding

In this method, the key is divided into several parts (which conveys the true meaning of the word *hash*). These parts are combined or folded together and are often transformed in a certain way to create the target address. There are two types of folding: *shift folding* and *boundary folding*.

The key is divided into several parts and these parts are then processed using a simple operation such as addition to combine them in a certain way. In shift folding, they are put underneath one another and then processed. For example, a social security number (SSN) 123-45-6789 can be divided into three parts, 123, 456, 789, and then these parts can be added. The resulting number, 1,368, can be divided modulo  $TSize$  or, if the size of the table is 1,000, the first three digits can be used for the address. To be sure, the division can be done in many different ways. Another possibility is to divide the same number 123-45-6789 into five parts (say, 12, 34, 56, 78, and 9), add them, and divide the result modulo  $TSize$ .

With boundary folding, the key is seen as being written on a piece of paper that is folded on the borders between different parts of the key. In this way, every other part

will be put in the reverse order. Consider the same three parts of the SSN: 123, 456, and 789. The first part, 123, is taken in the same order, then the piece of paper with the second part is folded underneath it so that 123 is aligned with 654, which is the second part, 456, in reverse order. When the folding continues, 789 is aligned with the two previous parts. The result is  $123 + 654 + 789 = 1,566$ .

In both versions, the key is usually divided into even parts of some fixed size plus some remainder and then added. This process is simple and fast, especially when bit patterns are used instead of numerical values. A bit-oriented version of shift folding is obtained by applying the exclusive-or operation,  $\wedge$ .

In the case of strings, one approach processes all characters of the string by “xor’ing” them together and using the result for the address. For example, for the string “abcd,”  $h(\text{“abcd”}) = \text{“a”} \wedge \text{“b”} \wedge \text{“c”} \wedge \text{“d.”}$  However, this simple method results in addresses between the numbers 0 and 127. For better result, chunks of strings are “xor’ed” together rather than single characters. These chunks are composed of the number of characters equal to the number of bytes in an integer. An integer in Java is 4 bytes long, so  $h(\text{“abcdefgh”}) = \text{“abcd”} \wedge \text{“efgh”}$  (most likely divided modulo  $TSize$ ). Such a function is used in the case study in this chapter.

### 10.1.3 Mid-Square Function

In the mid-square method, the key is *squared* and the middle or *mid* part of the result is used as the address. If the key is a string, it has to be preprocessed to produce a number by using, for instance, folding. In a mid-square hash function, the entire key participates in generating the address so that there is a better chance that different addresses are generated for different keys. For example, if the key is 3,121, then  $3,121^2 = 9,740,641$ , and for the 1,000-cell table,  $h(3,121) = 406$ , which is the middle part of  $3,121^2$ . In practice, it is more efficient to choose a power of 2 for the size of the table and extract the middle part of the bit representation of the square of a key. If we assume that the size of the table is 1,024, then, in this example, the binary representation of  $3,121^2$  is the bit string *100101001010000101100001*, with the middle part shown in italics. This middle part, the binary number 0101000010, is equal to 322. This part can easily be extracted by using a mask and a shift operation.

### 10.1.4 Extraction

In the extraction method, only a part of the key is used to compute the address. For the social security number 123-45-6789, this method might use the first four digits, 1,234; the last four, 6,789; the first two combined with the last two, 1,289; or some other combination. Each time, only a portion of the key is used. If this portion is carefully chosen, it can be sufficient for hashing, provided the omitted portion distinguishes the keys only in an insignificant way. For example, in some university settings, all international students’ ID numbers start with 999. Therefore, the first three digits can be safely omitted in a hash function that uses student IDs for computing table positions. Similarly, the starting digits of the ISBN code are the same for all books published by the same publisher (e.g., 0534 for Brooks/Cole Publishing Company). Therefore, they should be excluded from the computation of addresses if a data table contains only books from one publisher.

### 10.1.5 Radix Transformation

Using the radix transformation, the key  $K$  is transformed into another number base;  $K$  is expressed in a numerical system using a different radix. If  $K$  is the decimal number 345, then its value in base 9 (nonal) is 423. This value is then divided modulo  $TSize$ , and the resulting number is used as the address of the location to which  $K$  should be hashed. Collisions, however, cannot be avoided. If  $TSize = 100$ , then although 345 and 245 (decimal) are not hashed to the same location, 345 and 264 are because 264 decimal is 323 in the nonal system, and both 423 and 323 return 23 when divided modulo 100.

## 10.2 COLLISION RESOLUTION

Note that straightforward hashing is not without its problems, because for almost all hash functions, more than one key can be assigned to the same position. For example, if the hash function  $h_1$  applied to names returns the ASCII value of the first letter of each name (i.e.,  $h_1(name) = name[0]$ ), then all names starting with the same letter are hashed to the same position. This problem can be solved by finding a function that distributes names more uniformly in the table. For example, the function  $h_2$  could add the first two letters (i.e.,  $h_2(name) = name[0] + name[1]$ ), which is better than  $h_1$ . But even if all the letters are considered (i.e.,  $h_3(name) = name[0] + \dots + name[length(name) - 1]$ ), the possibility of hashing different names to the same location still exists. The function  $h_3$  is the best of the three because it distributes the names most uniformly for the three defined functions, but it also tacitly assumes that the size of the table has been increased. If the table has only 26 positions, which is the number of different values returned by  $h_1$ , there is no improvement using  $h_3$  instead of  $h_1$ . Therefore, one more factor can contribute to avoiding conflicts between hashed keys, namely, the size of the table. Increasing this size may lead to better hashing, but not always! These two factors—hash function and table size—may minimize the number of collisions, but they cannot completely eliminate them. The problem of collision has to be dealt with in a way that always guarantees a solution.

There are scores of strategies that attempt to avoid hashing multiple keys to the same location. Only a handful of these methods are discussed in this chapter.

### 10.2.1 Open Addressing

In the open addressing method, when a key collides with another key, the collision is resolved by finding an available table entry other than the position (address) to which the colliding key is originally hashed. If position  $h(K)$  is occupied, then the positions in the probing sequence

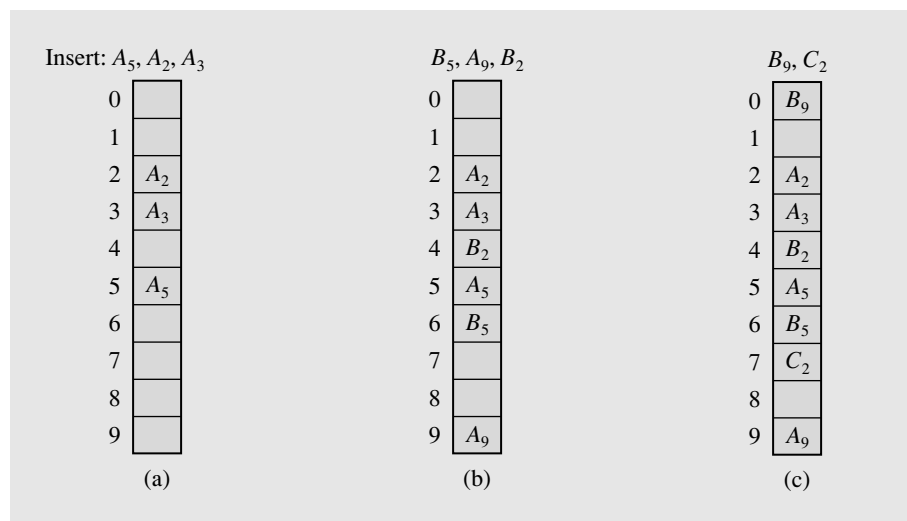
$$norm(h(K) + p(1)), norm(h(K) + p(2)), \dots, norm(h(K) + p(i)), \dots$$

are tried until either an available cell is found or the same positions are tried repeatedly or the table is full. Function  $p$  is a *probing function*,  $i$  is a *probe*, and  $norm$  is a *normalization function*, most likely, division modulo the size of the table.

The simplest method is *linear probing*, for which  $p(i) = i$ , and for the  $i$ th probe, the position to be tried is  $(h(K) + i) \bmod TSize$ . In linear probing, the position in which a

key can be stored is found by sequentially searching all positions starting from the position calculated by the hash function until an empty cell is found. If the end of the table is reached and no empty cell has been found, the search is continued from the beginning of the table and stops—in the extreme case—in the cell preceding the one from which the search started. Linear probing, however, has a tendency to create clusters in the table. Figure 10.1 contains an example where a key  $K_i$  is hashed to the position  $i$ . In Figure 10.1a, three keys— $A_5$ ,  $A_2$ , and  $A_3$ —have been hashed to their home positions. Then  $B_5$  arrives (Figure 10.1b), whose home position is occupied by  $A_5$ . Because the next position is available,  $B_5$  is stored there. Next,  $A_9$  is stored with no problem, but  $B_2$  is stored in position 4, two positions from its home address. A large cluster has already been formed. Next,  $B_9$  arrives. Position 9 is not available, and because it is the last cell of the table, the search starts from the beginning of the table, whose first slot can now host  $B_9$ . The next key,  $C_2$ , ends up in position 7, five positions from its home address.

**FIGURE 10.1** Resolving collisions with the linear probing method. Subscripts indicate the home positions of the keys being hashed.



In this example, the empty cells following clusters have a much greater chance to be filled than other positions. This probability is equal to  $(sizeof(cluster) + 1)/TSize$ . Other empty cells have only  $1/TSize$  chance of being filled. If a cluster is created, it has a tendency to grow, and the larger a cluster becomes, the larger is the likelihood that it will become even larger. This fact undermines the performance of the hash table for storing and retrieving data. The problem at hand is how to avoid cluster buildup. An answer can be found in a more careful choice of the probing function  $p$ .

One such choice is a quadratic function so that the resulting formula is

$$p(i) = h(K) + (-1)^{i-1}((i+1)/2)^2 \text{ for } i = 1, 2, \dots, TSize - 1$$

This rather cumbersome formula can be expressed in a simpler form as a sequence of probes:

$$h(K) + i^2, h(K) - i^2 \text{ for } i = 1, 2, \dots, (TSize - 1)/2$$

Including the first attempt to hash  $K$ , this results in the sequence:

$$h(K), h(K) + 1, h(K) - 1, h(K) + 4, h(K) - 4, \dots, h(K) + (TSize - 1)^2/4, \\ h(K) - (TSize - 1)^2/4$$

all divided modulo  $TSize$ . The size of the table should not be an even number, because only the even positions or only the odd positions are tried depending on the value of  $h(K)$ . Ideally, the table size should be a prime  $4j + 3$  of an integer  $j$ , which guarantees the inclusion of all positions in the probing sequence (Radke, 1970). For example, if  $j = 4$ , then  $TSize = 19$ , and assuming that  $h(K) = 9$  for some  $K$ , the resulting sequence of probes is<sup>1</sup>

$$9, 10, 8, 13, 5, 18, 0, 6, 12, 15, 3, 7, 11, 1, 17, 16, 2, 14, 4$$

The table from Figure 10.1 would have the same keys in a different configuration, as in Figure 10.2. It still takes two probes to locate  $B_2$  in some location, but for  $C_2$ , only four probes are required, not five.

**FIGURE 10.2** Using quadratic probing for collision resolution.

Insert: $A_5, A_2, A_3$	$B_5, A_9, B_2$	$B_9, C_2$
0 <input type="text"/>	0 <input type="text"/>	0 <input type="text" value="B&lt;sub&gt;9&lt;/sub&gt;"/>
1 <input type="text"/>	1 <input type="text" value="B&lt;sub&gt;2&lt;/sub&gt;"/>	1 <input type="text" value="B&lt;sub&gt;2&lt;/sub&gt;"/>
2 <input type="text" value="A&lt;sub&gt;2&lt;/sub&gt;"/>	2 <input type="text" value="A&lt;sub&gt;2&lt;/sub&gt;"/>	2 <input type="text" value="A&lt;sub&gt;2&lt;/sub&gt;"/>
3 <input type="text" value="A&lt;sub&gt;3&lt;/sub&gt;"/>	3 <input type="text" value="A&lt;sub&gt;3&lt;/sub&gt;"/>	3 <input type="text" value="A&lt;sub&gt;3&lt;/sub&gt;"/>
4 <input type="text"/>	4 <input type="text"/>	4 <input type="text"/>
5 <input type="text" value="A&lt;sub&gt;5&lt;/sub&gt;"/>	5 <input type="text" value="A&lt;sub&gt;5&lt;/sub&gt;"/>	5 <input type="text" value="A&lt;sub&gt;5&lt;/sub&gt;"/>
6 <input type="text"/>	6 <input type="text" value="B&lt;sub&gt;5&lt;/sub&gt;"/>	6 <input type="text" value="B&lt;sub&gt;5&lt;/sub&gt;"/>
7 <input type="text"/>	7 <input type="text"/>	7 <input type="text"/>
8 <input type="text"/>	8 <input type="text"/>	8 <input type="text" value="C&lt;sub&gt;2&lt;/sub&gt;"/>
9 <input type="text"/>	9 <input type="text" value="A&lt;sub&gt;9&lt;/sub&gt;"/>	9 <input type="text" value="A&lt;sub&gt;9&lt;/sub&gt;"/>
(a)	(b)	(c)

<sup>1</sup>Special care should be taken for negative numbers. When implementing these formulas, the operator  $\%$  means division modulo a modulus. However, this operator is usually implemented as the *remainder* of division. For example,  $-6 \% 23$  is equal to  $-6$ , and not to  $17$ , as expected. Therefore, when using the operator  $\%$  for the implementation of division modulo, the modulus (the right operand of  $\%$ ) should be added to the result when the result is negative. Therefore,  $(-6 \% 23) + 23$  returns  $17$ .

Note that the formula determining the sequence of probes chosen for quadratic probing is not  $h(K) + i^2$ , for  $i = 1, 2, \dots, TSize - 1$ , because the first half of the sequence

$$h(K) + 1, h(K) + 4, h(K) + 9, \dots, h(K) + (TSize - 1)^2$$

covers only half of the table, and the second half of the sequence repeats the first half in the reverse order. For example, if  $TSize = 19$ , and  $h(K) = 9$ , then the sequence is

$$9, 10, 13, 18, 6, 15, 7, 1, 16, 14, 14, 16, 1, 7, 15, 6, 18, 13, 10$$

This is not an accident. The probes that render the same address are of the form

$$i = TSize/2 + 1 \text{ and } j = TSize/2 - 1$$

and they are probes for which

$$i^2 \bmod TSize = j^2 \bmod TSize$$

that is,

$$(i^2 - j^2) \bmod TSize$$

In this case,

$$\begin{aligned} (i^2 - j^2) &= (TSize/2 + 1)^2 - (TSize/2 - 1)^2 \\ &= (TSize^2/4 + TSize + 1 - TSize^2/4 + TSize - 1) \\ &= 2TSize \end{aligned}$$

and to be sure,  $2TSize \bmod TSize = 0$ .

Although using quadratic probing gives much better results than linear probing, the problem of cluster buildup is not avoided altogether, because for keys hashed to the same location, the same probe sequence is used. Such clusters are called *secondary clusters*. These secondary clusters, however, are less harmful than primary clusters.

Another possibility is to have  $p$  be a random number generator (Morris 1968), which eliminates the need to take special care about the table size. This approach prevents the formation of secondary clusters, but it causes a problem with repeating the same probing sequence for the same keys. If the random number generator is initialized at the first invocation, then different probing sequences are generated for the same key  $K$ . Consequently,  $K$  is hashed more than once to the table, and even then it might not be found when searched. Therefore, the random number generator should be initialized to the same seed for the same key before beginning the generation of the probing sequence. This can be achieved in Java by using the `setSeed()` method with a parameter that depends on the key; for example,  $p(i) = \text{setSeed}(\text{sizeof}(K)) \cdot i$  or  $\text{setSeed}(K[0]) + i$ . Also, the constructor `Random()` with a parameter can be used. To avoid relying on `setSeed()`, a random number generator can be written that assures that each invocation generates a unique number between 0 and  $TSize - 1$ . The following algorithm was developed by Robert Morris for tables with  $TSize = 2^n$  for some integer  $n$ :

```
int r = 1;
generateNumber()
    r = 5*r;
    r = mask out n + 2 low-order bits of r;
    return r/4;
```

The problem of secondary clustering is best addressed with *double hashing*. This method utilizes two hash functions, one for accessing the primary position of a key,  $h$ , and a second function,  $h_p$ , for resolving conflicts. The probing sequence becomes

$$h(K), h(K) + h_p(K), \dots, h(K) + i \cdot h_p(K), \dots$$

(all divided modulo  $TSize$ ). The table size should be a prime number so that each position in the table can be included in the sequence. Experiments indicate that secondary clustering is generally eliminated because the sequence depends on the values of  $h_p$ , which, in turn, depend on the key. Therefore, if the key  $K_1$  is hashed to the position  $j$ , the probing sequence is

$$j, j + h_p(K_1), j + 2 \cdot h_p(K_1), \dots$$

(all divided modulo  $TSize$ ). If another key  $K_2$  is hashed to  $j + h_p(K_1)$ , then the next position tried is  $j + h_p(K_1) + h_p(K_2)$ , not  $j + 2 \cdot h_p(K_1)$ , which avoids secondary clustering if  $h_p$  is carefully chosen. Also, even if  $K_1$  and  $K_2$  are hashed primarily to the same position  $j$ , the probing sequences can be different for each. This, however, depends on the choice of the second hash function,  $h_p$ , which may render the same sequences for both keys. This is the case for function  $h_p(K) = K.length$  when both keys are of the same length.

Using two hash functions can be time-consuming, especially for sophisticated functions. Therefore, the second hash function can be defined in terms of the first, as in  $h_p(K) = i \cdot h(K) + 1$ . The probing sequence for  $K_1$  is

$$j, 2j + 1, 5j + 2, \dots$$

(modulo  $TSize$ ). If  $K_2$  is hashed to  $2j + 1$ , then the probing sequence for  $K_2$  is

$$2j + 1, 4j + 3, 10j + 11, \dots$$

which does not conflict with the former sequence. Thus, it does not lead to cluster buildup.

How efficient are all these methods? Obviously, it depends on the size of the table and on the number of elements already in the table. The inefficiency of these methods is especially evident for *unsuccessful searches*, searching for elements not in the table. The more elements in the table, the more likely it is that clusters will form (primary or secondary) and the more likely it is that these clusters are large.

Consider the case when linear probing is used for collision resolution. If  $K$  is not in the table, then starting from the position  $h(K)$ , all consecutively occupied cells are checked; the longer the cluster, the longer it takes to determine that  $K$ , in fact, is not in the table. In the extreme case, when the table is full, we have to check all the cells starting from  $h(K)$  and ending with  $(h(K) - 1) \bmod TSize$ . Therefore, the search time increases with the number of elements in the table.

There are formulas that approximate the number of times for successful and unsuccessful searches for different hashing methods. These formulas were developed by Donald Knuth and are considered by Thomas Standish to be “among the prettiest in computer science.” Figure 10.3 contains these formulas. Figure 10.4 contains a table showing the number of searches for different percentages of occupied cells. This table indicates that the formulas from Figure 10.3 provide only approximations of the



**FIGURE 10.3** Formulas approximating, for different hashing methods, the average numbers of trials for successful and unsuccessful searches (Knuth, 1998).

	Linear Probing	Quadratic Probing <sup>a</sup>	Double Hashing
successful search	$\frac{1}{2} \left( 1 + \frac{1}{1-LF} \right)$	$1 - \ln(1-LF) - \frac{LF}{2}$	$\frac{1}{LF} \ln \frac{1}{1-LF}$
unsuccessful search	$\frac{1}{2} \left( 1 + \frac{1}{(1-LF)^2} \right)$	$\frac{1}{1-LF} - LF - \ln(1-LF)$	$\frac{1}{1-LF}$
Load Factor	$LF = \frac{\text{number of elements in the table}}{\text{table size}}$		

<sup>a</sup> The formulas given in this column approximate any open addressing method that causes secondary clusters to arise, and quadratic probing is only one of them.

**FIGURE 10.4** The average numbers of successful searches and unsuccessful searches for different collision resolution methods.

LF	Linear Probing		Quadratic Probing		Double Hashing	
	Successful	Unsuccessful	Successful	Unsuccessful	Successful	Unsuccessful
0.05	1.0	1.1	1.0	1.1	1.0	1.1
0.10	1.1	1.1	1.1	1.1	1.1	1.1
0.15	1.1	1.2	1.1	1.2	1.1	1.2
0.20	1.1	1.3	1.1	1.3	1.1	1.2
0.25	1.2	1.4	1.2	1.4	1.2	1.3
0.30	1.2	1.5	1.2	1.5	1.2	1.4
0.35	1.3	1.7	1.3	1.6	1.2	1.5
0.40	1.3	1.9	1.3	1.8	1.3	1.7
0.45	1.4	2.2	1.4	2.0	1.3	1.8
0.50	1.5	2.5	1.4	2.2	1.4	2.0
0.55	1.6	3.0	1.5	2.5	1.5	2.2
0.60	1.8	3.6	1.6	2.8	1.5	2.5
0.65	1.9	4.6	1.7	3.3	1.6	2.9
0.70	2.2	6.1	1.9	3.8	1.7	3.3
0.75	2.5	8.5	2.0	4.6	1.8	4.0
0.80	3.0	13.0	2.2	5.8	2.0	5.0
0.85	3.8	22.7	2.5	7.7	2.2	6.7
0.90	5.5	50.5	2.9	11.4	2.6	10.0
0.95	10.5	200.5	3.5	22.0	3.2	20.0

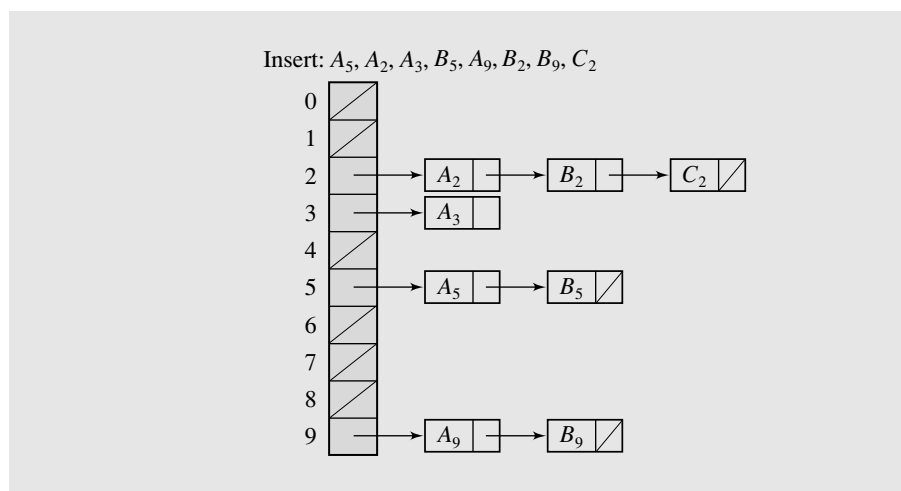
number of searches. This is particularly evident for the higher percentages. For example, if 90 percent of the cells are occupied, then linear probing requires 50 trials to determine that the key being searched for is not in the table. However, for the full table of 10 cells, this number is 10, not 50.

For the lower percentages, the approximations computed by these formulas are closer to the real values. The table in Figure 10.4 indicates that if the table is 65 percent full, then linear probing requires, on average, fewer than two trials to find an element in the table. Because this number is usually an acceptable limit for a hash function, linear probing requires 35 percent of the spaces in the table to be unoccupied to keep performance at an acceptable level. This may be considered too wasteful, especially for very large tables or files. This percentage is lower for a quadratic probing (25 percent) and for double hashing (20 percent), but it may still be considered large. Double hashing requires one cell out of five to be empty, which is a relatively high fraction. But all these problems can be solved by allowing more than one item to be stored in a given position or in an area associated with one position.

### 10.2.2 Chaining

Keys do not have to be stored in the table itself. In *chaining*, each position of the table is associated with a linked list or *chain* of structures whose `info` fields store keys or references to keys. This method is called *separate chaining*, and a table of references (pointers) is called a *scatter table*. In this method, the table can never overflow, because the linked lists are extended only upon the arrival of new keys, as illustrated in Figure 10.5. For short linked lists, this is a very fast method, but increasing the length of these lists can significantly degrade retrieval performance. Performance can be improved by maintaining an order on all these lists so that, for unsuccessful searches,

**FIGURE 10.5** In chaining, colliding keys are put on the same linked list.



an exhaustive search is not required in most cases or by using self-organizing linked lists (Pagli, 1985).

This method requires additional space for maintaining references. The table stores only references, and each node requires one reference field. Therefore, for  $n$  keys,  $n + TSize$  references are needed, which for large  $n$  can be a very demanding requirement.

A version of chaining called *coalesced hashing* (or *coalesced chaining*) combines linear probing with chaining. In this method, the first available position is found for a key colliding with another key, and the index of this position is stored with the key already in the table. In this way, a sequential search down the table can be avoided by directly accessing the next element on the linked list. Each position  $pos$  of the table includes two fields: an `info` field for a key and a `next` field with the index of the next key that is hashed to  $pos$ . Available positions can be marked by, say,  $-2$  in `next`;  $-1$  can be used to indicate the end of a chain. This method requires  $TSize \cdot (\text{sizeof}(\text{reference}) + \text{sizeof}(\text{next}))$  more space for the table in addition to the space required for the keys. This is less than for chaining, but the table size limits the number of keys that can be hashed into the table.

An overflow area known as a *cellar* can be allocated to store keys for which there is no room in the table.

Figure 10.6 illustrates an example where coalesced hashing puts a colliding key in the last position of the table. In Figure 10.6a, no collision occurs. In Figure 10.6b,  $B_5$  is put in the last cell of the table, which is found occupied by  $A_9$  when it arrives. Hence,  $A_9$  is attached to the list accessible from position 9. In Figure 10.6c, two new colliding keys are added to the corresponding lists.

**FIGURE 10.6** Coalesced hashing puts a colliding key in the last available position of the table.

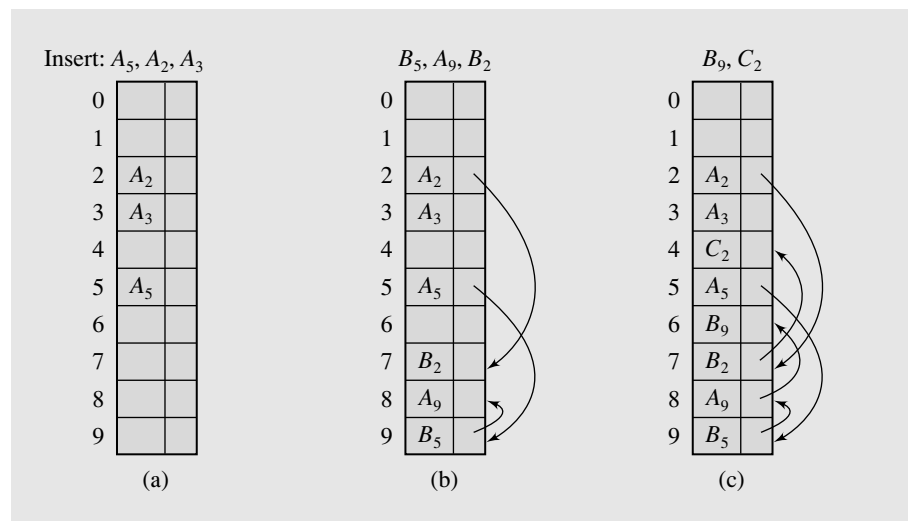
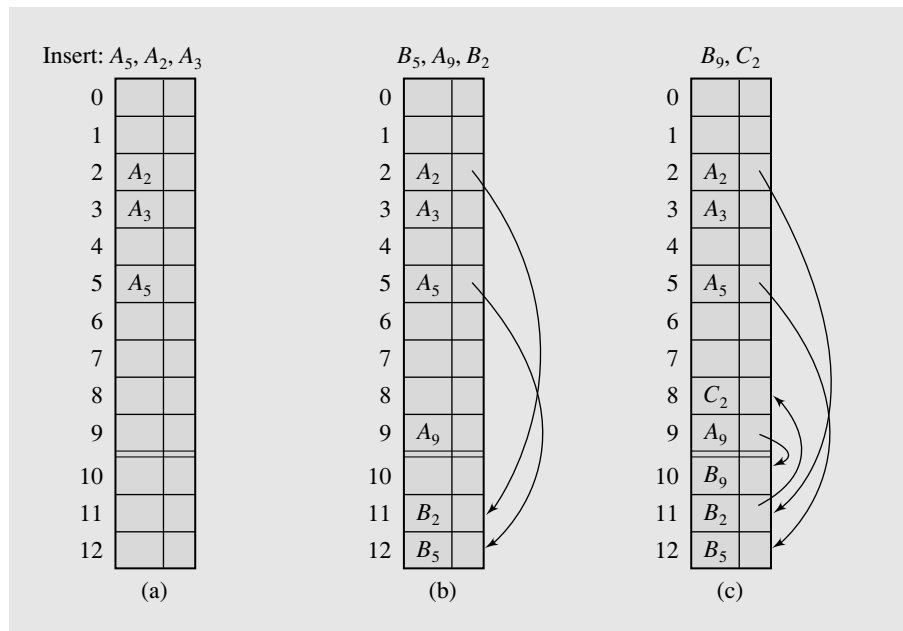


Figure 10.7 illustrates coalesced hashing that uses a cellar. Noncolliding keys are stored in their home positions, as in Figure 10.7a. Colliding keys are put in the last available slot of the cellar and added to the list starting from their home position, as in Figure 10.7b. In Figure 10.7c, the cellar is full, so an available cell is taken from the table when  $C_2$  arrives.

**FIGURE 10.7** Coalesced hashing that uses a cellar.

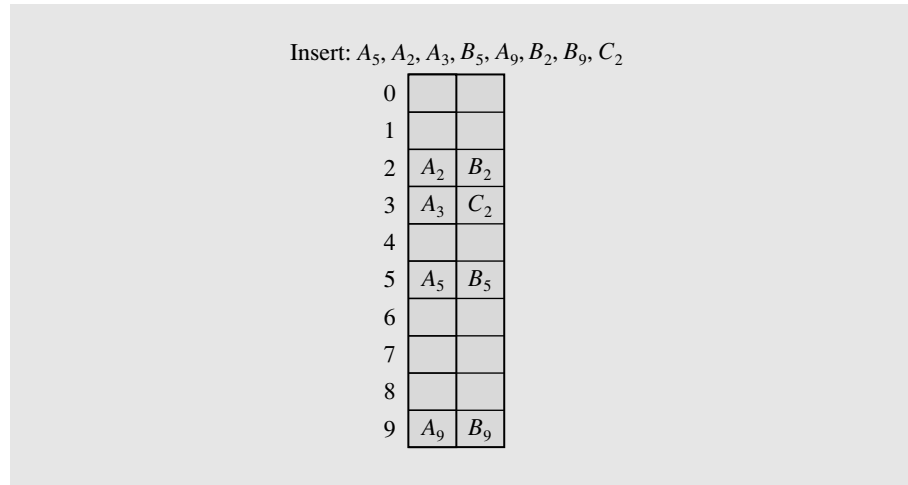
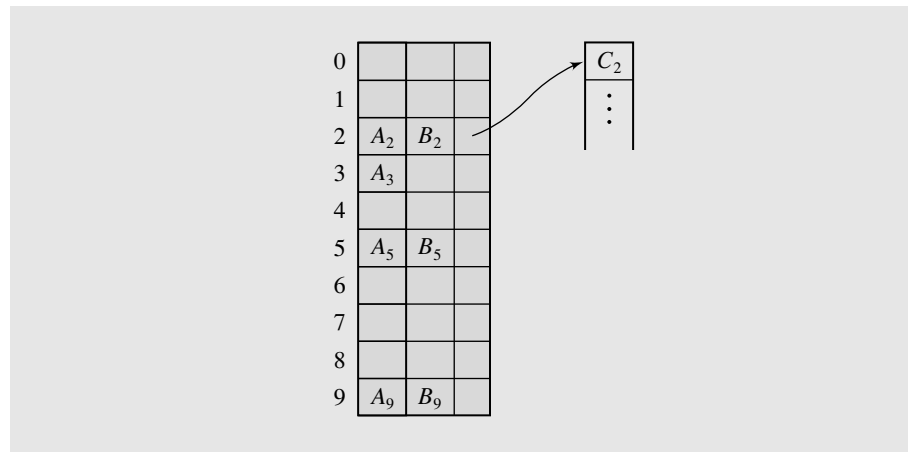


### 10.2.3 Bucket Addressing

Another solution to the collision problem is to store colliding elements in the same position in the table. This can be achieved by associating a *bucket* with each address. A bucket is a block of space large enough to store multiple items.

By using buckets, the problem of collisions is not totally avoided. If a bucket is already full, then an item hashed to it has to be stored somewhere else. By incorporating the open addressing approach, the colliding item can be stored in the next bucket if it has an available slot when using linear probing, as illustrated in Figure 10.8, or it can be stored in some other bucket when, say, quadratic probing is used.

The colliding items can also be stored in an overflow area. In this case, each bucket includes a field that indicates whether the search should be continued in this area or not. It can be simply a yes/no marker. In conjunction with chaining, this marker can be the number indicating the position in which the beginning of the linked list associated with this bucket can be found in the overflow area (see Figure 10.9).

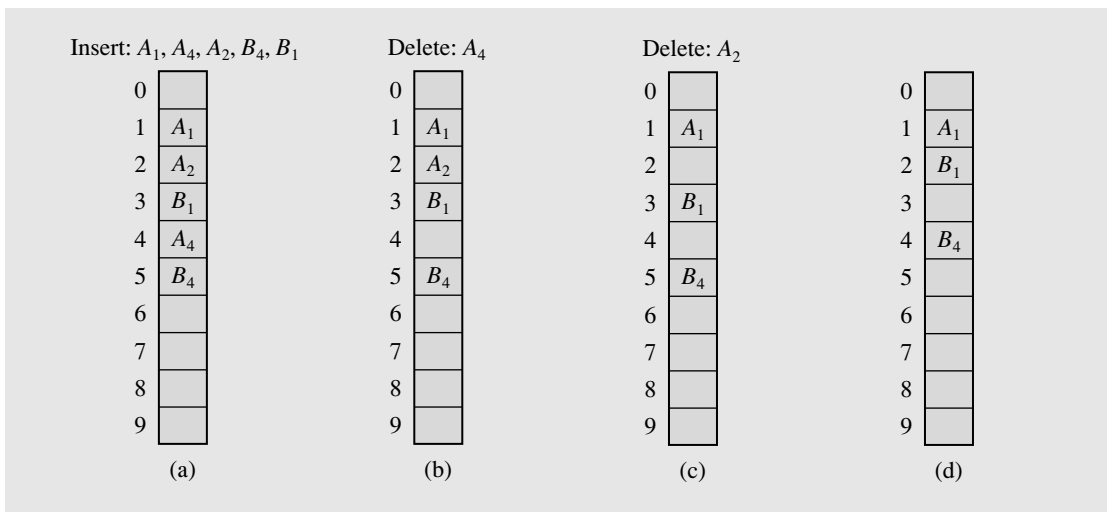
**FIGURE 10.8** Collision resolution with buckets and linear probing method.**FIGURE 10.9** Collision resolution with buckets and overflow area.

## 10.3 DELETION

How can we remove data from a hash table? With a chaining method, deleting an element leads to the deletion of a node from a linked list holding the element. For other methods, a deletion operation may require a more careful treatment of collision resolution, except for the rare occurrence when a perfect hash function is used.

Consider the table in Figure 10.10a in which the keys are stored using linear probing. The keys have been entered in the following order:  $A_1$ ,  $A_4$ ,  $A_2$ ,  $B_4$ ,  $B_1$ . After  $A_4$  is deleted and position 4 is freed (Figure 10.10b), we try to find  $B_4$  by first checking position 4. But this position is now empty, so we may conclude that  $B_4$  is not in the table. The same result occurs after deleting  $A_2$  and marking cell 2 as empty (Figure 10.10c). Then, the search for  $B_1$  is unsuccessful, because if we are using linear probing, the search terminates at position 2. The situation is the same for the other open addressing methods.

**FIGURE 10.10** Linear search in the situation where both insertion and deletion of keys are permitted.



If we leave deleted keys in the table with markers indicating that they are not valid elements of the table, any subsequent search for an element does not terminate prematurely. When a new key is inserted, it overwrites a key that is only a space filler. However, for a large number of deletions and a small number of additional insertions, the table becomes overloaded with deleted records, which increases the search time because the open addressing methods require testing the deleted elements. Therefore, the table should be purged after a certain number of deletions by moving undeleted elements to the cells occupied by deleted elements. Cells with deleted elements that are not overwritten by this procedure are marked as free. Figure 10.10d illustrates this situation.

## 10.4 PERFECT HASH FUNCTIONS

All the cases discussed so far assume that the body of data is not precisely known. Therefore, the hash function only rarely turned out to be an ideal hash function in the sense that it immediately hashed a key to its proper position and avoided any collisions. In most cases, some collision resolution technique had to be included, because sooner or later, a key would arrive that conflicted with another key in the table. Also,

the number of keys is rarely known in advance, so the table had to be large enough to accommodate all the arriving data. Moreover, the table size contributed to the number of collisions: A larger table has a smaller number of collisions (provided the hash function took table size into consideration). All this was caused by the fact that the body of data to be hashed in the table was not precisely known ahead of time. Therefore, a hash function was first devised and then the data were processed.

In many situations, however, the body of data is fixed, and a hash function can be devised after the data are known. Such a function may really be a perfect hash function if it hashes items on the first attempt. In addition, if such a function requires only as many cells in the table as the number of data so that no empty cell remains after hashing is completed, it is called a *minimal perfect hash function*. Wasting time for collision resolution and wasting space for unused table cells are avoided in a minimal perfect hash function.

Processing a fixed body of data is not an uncommon situation. Consider the following examples: a table of reserved words used by assemblers or compilers, files on unerasable optical disks, dictionaries, and lexical databases.

Algorithms for choosing a perfect hash function usually require tedious work due to the fact that perfect hash functions are rare. As already indicated for 50 elements and a 100-cell array, only one in 1 million is perfect. Other functions lead to collisions.

#### 10.4.1 Cichelli's Method

One algorithm to construct a minimal perfect hash function was developed by Richard J. Cichelli. It is used to hash a relatively small number of reserved words. The function is of the form

$$h(\text{word}) = (\text{length}(\text{word}) + g(\text{firstletter}(\text{word})) + g(\text{lastletter}(\text{word}))) \bmod T\text{Size}$$

where  $g$  is the function to be constructed. The function  $g$  assigns values to letters so that the resulting function  $h$  returns unique hash values for all words in a predefined set of words. The values assigned by  $g$  to particular letters do not have to be unique. The algorithm has three parts: computation of the letter occurrences, ordering the words, and searching. The last step is the heart of this algorithm and uses an auxiliary function  $\text{try}()$ . Cichelli's algorithm for constructing  $g$  and  $h$  is as follows:

```

choose a value for max;
compute the number of occurrences of each first and last letter in the set of all words;
order all words in accordance to the frequency of occurrence of the first and the last letters;
search(wordList)
    if wordList is empty
        halt;
    word = first word from wordList;
    wordList = wordList with the first word detached;
    if the first and the last letters of word are assigned g-values
        try(word, -1, -1); // -1 signifies 'value already assigned'
        if success
            search(wordList);
    put word at the beginning of wordList and detach its hash value;

```

```

else if neither the first nor the last letter has a g-value
  for each  $n, m$  in  $\{0, \dots, Max\}$ 
    try(word,  $n, m$ );
    if success
      search(wordList);
      put word at the beginning of wordList and detach its hash value;
else if either the first or the last letter has a g-value
  for each  $n$  in  $\{0, \dots, Max\}$ 
    try(word,  $-1, n$ ) or try(word,  $n, -1$ );
    if success
      search(wordList);
      put word at the beginning of wordList and detach its hash value;

try(word, firstLetterValue, lastLetterValue)
  if  $h(\text{word})$  has not been claimed
    reserve  $h(\text{word})$ ;
    assign firstLetterValue and/or lastLetterValue as g-values of firstletter(word)
    and/or lastletter(word) if they are not -1 (i.e., not assigned);
    return success;
    return failure;

```

We can use this algorithm to build a hash function for the names of the nine Muses: Calliope, Clio, Erato, Euterpe, Melpomene, Polyhymnia, Terpsichore, Thalia, and Urania. A simple count of the letters renders the number of times a given letter occurs as a first and last letter (case sensitivity is disregarded): E (6), A (3), C (2), O (2), T (2), M (1), P (1), and U (1). According to these frequencies, the words can be put in the following order: Euterpe (E occurs six times as the first and the last letter), Calliope, Erato, Terpsichore, Melpomene, Thalia, Clio, Polyhymnia, and Urania.

Now the procedure `search()` is applied. Figure 10.11 contains a summary of its execution, in which  $Max = 4$ . First, the word Euterpe is tried. E is assigned the  $g$ -value of 0, whereby  $h(\text{Euterpe}) = 7$ , which is put on the list of reserved hash values. Everything goes well until Urania is tried. All five possible  $g$ -values for U result in an already reserved hash value. The procedure backtracks to the preceding step, when Polyhymnia was tried. Its current hash value is detached from the list, and the  $g$ -value of 1 is tried for P, which causes a failure, but 2 for P gives 3 for the hash value, so the algorithm can continue. Urania is tried again five times, then the fifth attempt is successful. All the names have been assigned unique hash values and the search process is finished. If the  $g$ -values for each letter are  $A = C = E = O = M = T = 0$ ,  $P = 2$ , and  $U = 4$ , then  $h$  is the minimal perfect hash function for the nine Muses.

The searching process in Cichelli's algorithm is exponential because it uses an exhaustive search, and thus, it is inapplicable to a large number of words. Also, it does not guarantee that a perfect hash function can be found. For a small number of words, however, it usually gives good results. This program often needs to be run only once, and the resulting hash function can be incorporated into another program. Cichelli applied his method to the Pascal reserved words. The result was a hash function that reduced the run time of a Pascal cross-reference program by 10 percent after it replaced the binary search used previously.



**FIGURE 10.11** Subsequent invocations of the searching procedure with  $Max = 4$  in Cichelli's algorithm assign the indicated values to letters and to the list of reserved hash values. The asterisks indicate failures.

			reserved hash values
Euterpe	E = 0	h = 7	{7}
Calliope	C = 0	h = 8	{7 8}
Erato	O = 0	h = 5	{5 7 8}
Terpsichore	T = 0	h = 2	{2 5 7 8}
Melpomene	M = 0	h = 0	{0 2 5 7 8}
Thalia	A = 0	h = 6	{0 2 5 6 7 8}
Clio		h = 4	{0 2 4 5 6 7 8}
Polyhymnia	P = 0	h = 1	{0 1 2 4 5 6 7 8}
Urania	U = 0	h = 6 *	{0 1 2 4 5 6 7 8}
Urania	U = 1	h = 7 *	{0 1 2 4 5 6 7 8}
Urania	U = 2	h = 8 *	{0 1 2 4 5 6 7 8}
Urania	U = 3	h = 0 *	{0 1 2 4 5 6 7 8}
Urania	U = 4	h = 1 *	{0 1 2 4 5 6 7 8}
Polyhymnia	P = 1	h = 2 *	{0 2 4 5 6 7 8}
Polyhymnia	P = 2	h = 3	{0 2 3 4 5 6 7 8}
Urania	U = 0	h = 6 *	{0 2 3 4 5 6 7 8}
Urania	U = 1	h = 7 *	{0 2 3 4 5 6 7 8}
Urania	U = 2	h = 8 *	{0 2 3 4 5 6 7 8}
Urania	U = 3	h = 0 *	{0 2 3 4 5 6 7 8}
Urania	U = 4	h = 1	{0 1 2 3 4 5 6 7 8}

There have been many successful attempts to extend Cichelli's technique and overcome its shortcomings. One technique modified the terms involved in the definition of the hash function. For example, other terms, the alphabetical positions of the second to last letter in the word, are added to the function definition (Sebesta and Taylor, 1986), or the following definition is used (Haggard and Karplus, 1986):

$$h(\text{word}) = \text{length}(\text{word}) + g_1(\text{firstletter}(\text{word})) + \dots + g_{\text{length}(\text{word})}(\text{lastletter}(\text{word}))$$

Cichelli's method can also be modified by partitioning the body of data into separate buckets for which minimal perfect hash functions are found. The partitioning is performed by a grouping function,  $gr$ , which for each word indicates the bucket to which it belongs. Then a general hash function is generated whose form is

$$h(\text{word}) = \text{bucket}_{gr(\text{word})} + h_{gr(\text{word})}(\text{word})$$

(e.g., Lewis and Cook, 1986). The problem with this approach is that it is difficult to find a generally applicable grouping function tuned to finding minimal perfect hash functions.

Both these ways—modifying hash function and partitioning—are not entirely successful if the same Cichelli's algorithm is used. Although Cichelli ends his paper

with the adage: “When all else fails, try brute force,” the attempts to modify his approach included devising a more efficient searching algorithm to circumvent the need for brute force. One such approach is incorporated in the FHCD algorithm.

### 10.4.2 The FHCD Algorithm

An extension of Cichelli’s approach is a method devised by Thomas Sager. The FHCD algorithm (Fox et al., 1992) is a modification of Sager’s method, and it is discussed in this section. The FHCD algorithm searches for a minimal perfect hash function of the form

$$h(\text{word}) = h_0(\text{word}) + g(h_1(\text{word})) + g(h_2(\text{word}))$$

(modulo  $TSize$ ), where  $g$  is the function to be determined by the algorithm. To define the functions  $h_i$ , three tables— $T_0$ ,  $T_1$ , and  $T_2$ —of random numbers are defined, one for each function  $h_i$ . Each word is equal to a string of characters  $c_1c_2 \dots c_m$  corresponding to a triple  $(h_0(\text{word}), h_1(\text{word}), h_2(\text{word}))$  whose elements are calculated according to the formulas

$$\begin{aligned} h_0 &= (T_0(c_1) + \dots + T_0(c_m)) \bmod n \\ h_1 &= (T_1(c_1) + \dots + T_1(c_m)) \bmod r \\ h_2 &= ((T_2(c_1) + \dots + T_2(c_m)) \bmod r) + r \end{aligned}$$

where  $n$  is the number of all words in the body of data,  $r$  is a parameter usually equal to  $n/2$  or less, and  $T_i(c_j)$  is the number generated in table  $T_i$  for  $c_j$ . The function  $g$  is found in three steps: *mapping*, *ordering*, and *searching*.

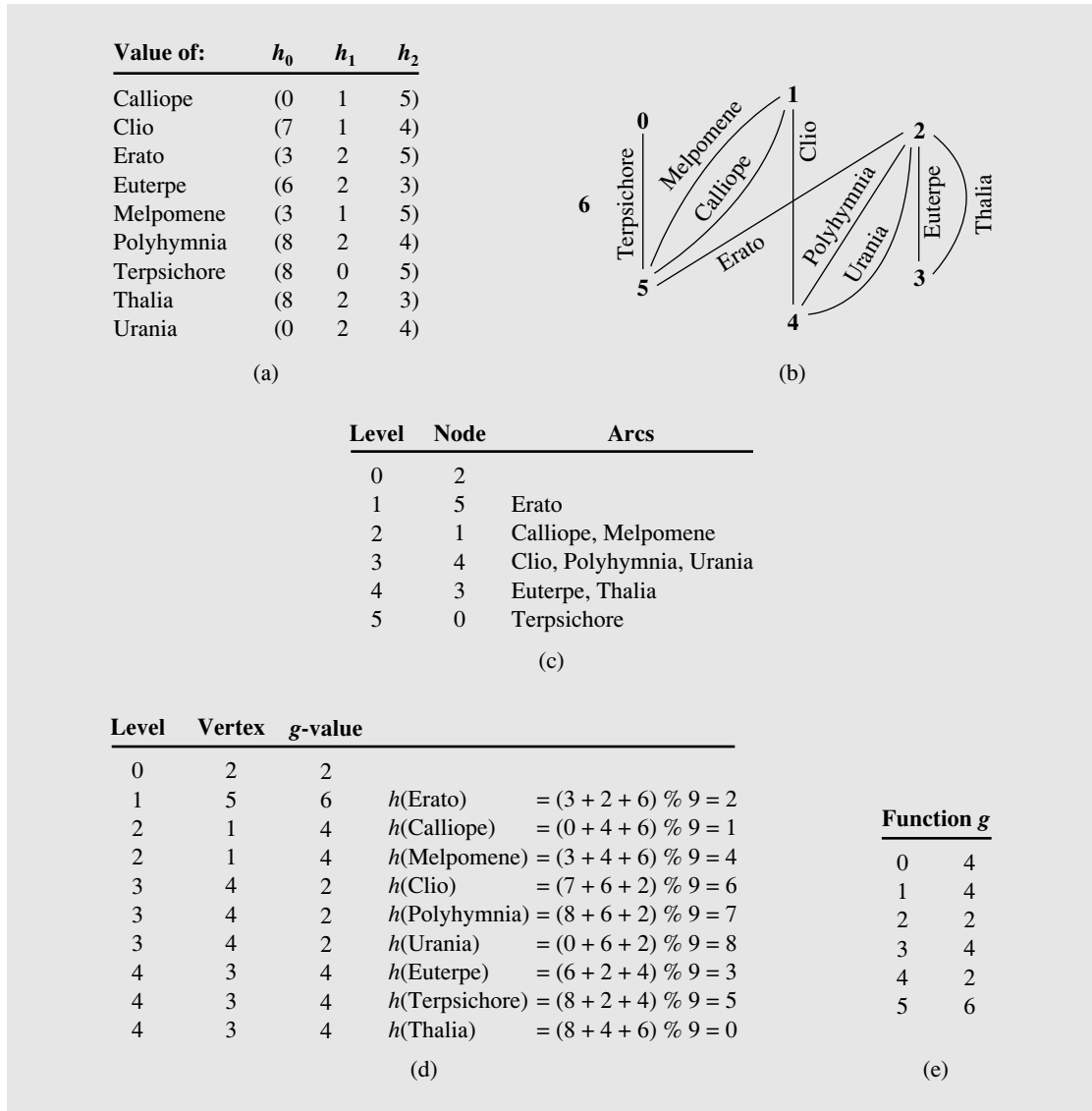
In the mapping step,  $n$  triples  $(h_0(\text{word}), h_1(\text{word}), h_2(\text{word}))$  are created. The randomness of functions  $h_i$  usually guarantees the uniqueness of these triples; should they not be unique, new tables  $T_i$  are generated. Next, a *dependency graph* is built. It is a bipartite graph with half of its vertices corresponding to the  $h_1$  values and labeled 0 through  $r - 1$  and the other half to the  $h_2$  values and labeled  $r$  through  $2r - 1$ . Each word corresponds to an edge of the graph between the vertices  $h_1(\text{word})$  and  $h_2(\text{word})$ . The mapping step is expected to take  $O(n)$  time.

As an example, we again use the set of names of the nine Muses. To generate three tables  $T_i$ , the random number generator from class `Random` can be used, and with these tables, a set of nine triples is computed, as shown in Figure 10.12a. Figure 10.12b contains a corresponding dependency graph with  $r = 3$ . Note that some vertices cannot be connected to any other vertices, and some pairs of vertices can be connected with more than one arc.

The ordering step rearranges all the vertices so that they can be partitioned into a series of levels. When a sequence  $v_1, \dots, v_t$  of vertices is established, then a level  $K(v_i)$  of keys is defined as a set of all the edges that connect  $v_i$  with those  $v_j$ s for which  $j \leq i$ . The sequence is initiated with a vertex of maximum degree. Then, for each successive position  $i$  of the sequence, a vertex  $v_i$  is selected from among the vertices having at least one connection to the vertices  $v_1, \dots, v_{i-1}$ , which has maximal degree. When no such vertex can be found, any vertex of maximal degree is chosen from among the unselected vertices. Figure 10.12c contains an example.

In the last step, *searching*, hash values are assigned to keys level by level. The  $g$ -value for the first vertex is chosen randomly among the numbers  $0, \dots, n - 1$ . For the

**FIGURE 10.12** Applying the FHCD algorithm to the names of the nine Muses.



other vertices, because of their construction and ordering, we have the following relation: If  $v_i < r$ , then  $v_i = h_1$ . Thus, each word in  $K(v_i)$  has the same value  $g(h_1(\text{word})) = g(v_i)$ . Also,  $g(h_2(\text{word}))$  has already been defined, because it is equal to some  $v_j$  that has already been processed. Analogical reasoning can be applied to the case when  $v_i > r$  and then  $v_i = h_2$ . For each word, either  $g(h_1(\text{word}))$  or  $g(h_2(\text{word}))$  is known. The second  $g$ -value is found randomly for each level so that the values obtained from the formula of the minimal perfect hash function  $h$  indicate the positions in the hash table that are

available. Because the first choice of a random number will not always fit all words on a given level to the hash table, both random numbers may need to be tried.

The searching step for the nine Muses starts with randomly choosing  $g(v_1)$ . Let  $g(2) = 2$ , where  $v_1 = 2$ . The next vertex is  $v_2 = 5$  so that  $K(v_2) = \{\text{Erato}\}$ . According to Figure 10.12a,  $h_0(\text{Erato}) = 3$ , and because the edge *Erato* connects  $v_1$  and  $v_2$ , either  $h_1(\text{Erato})$  or  $h_2(\text{Erato})$  must be equal to  $v_1$ . We can see that  $h_1(\text{Erato}) = 2 = v_1$ ; hence,  $g(h_1(\text{Erato})) = g(v_1) = 2$ . A value for  $g(v_2) = g(h_2(\text{Erato})) = 6$  is chosen randomly. From this,  $h(\text{Erato}) = (h_0(\text{Erato}) + g(h_1(\text{Erato})) + g(h_2(\text{Erato}))) \bmod TSize = (3 + 2 + 6) \bmod 9 = 2$ . This means that position 2 of the hash table is no longer available. The new  $g$ -value,  $g(5) = 6$ , is retained for later use.

Now,  $v_3 = 1$  is tried, with  $K(v_3) = \{\text{Calliope, Melpomene}\}$ . The  $h_0$ -values for both words are retrieved from the table of triples, and the  $g(h_2)$ -values are equal to 6 for both words, because  $h_2 = v_2$  for both of them. Now we must find a random  $g(h_1)$ -value such that the hash function  $h$  computed for both words renders two numbers different from 2, because position two is already occupied. Assume that this number is 4. As a result,  $h(\text{Calliope}) = 1$  and  $h(\text{Melpomene}) = 4$ . Figure 10.12d contains a summary of all the steps. Figure 10.12e shows the values of the function  $g$ . Through these values of  $g$ , the function  $h$  becomes a minimal perfect hash function. However, because  $g$  is given in tabular form and not with a neat formula, it has to be stored as a table to be used every time function  $h$  is needed, which may not be a trivial task. The function  $g: \{0, \dots, 2r - 1\} \rightarrow \{0, \dots, n - 1\}$ , and the size of  $g$ 's domain increases with  $r$ . The parameter  $r$  is approximately  $n/2$ , which for large databases means that the table storing all values for  $g$  is not of a negligible size. This table has to be kept in main memory to make computations of the hash function efficient.

## 10.5 HASH FUNCTIONS FOR EXTENDIBLE FILES

All the methods discussed so far work on tables of fixed sizes. This is a reasonable assumption for arrays, but for files it may be too restrictive. After all, file sizes change dynamically by adding new elements or deleting old ones. Some hashing techniques can be used in this situation, such as coalesced hashing or hashing with chaining, but some of them may be inadequate. New techniques have been developed that specifically take into account the variable size of the table or file. We can distinguish two classes of such techniques: directory and directoryless.

In the directory schemes, key access is mediated by the access to a directory or an index of keys in the structure. There are several techniques and modifications to those techniques in the category of the directory schemes. We mention only a few: *expandable hashing* (Knott, 1971), *dynamic hashing* (Larson, 1978), and *extendible hashing* (Fagin et al., 1979). All three methods distribute keys among buckets in a similar fashion. The main difference is the structure of the index (directory). In expandable hashing and dynamic hashing, a binary tree is used as an index of buckets. On the other hand, in extendible hashing, a directory of records is kept in a table.

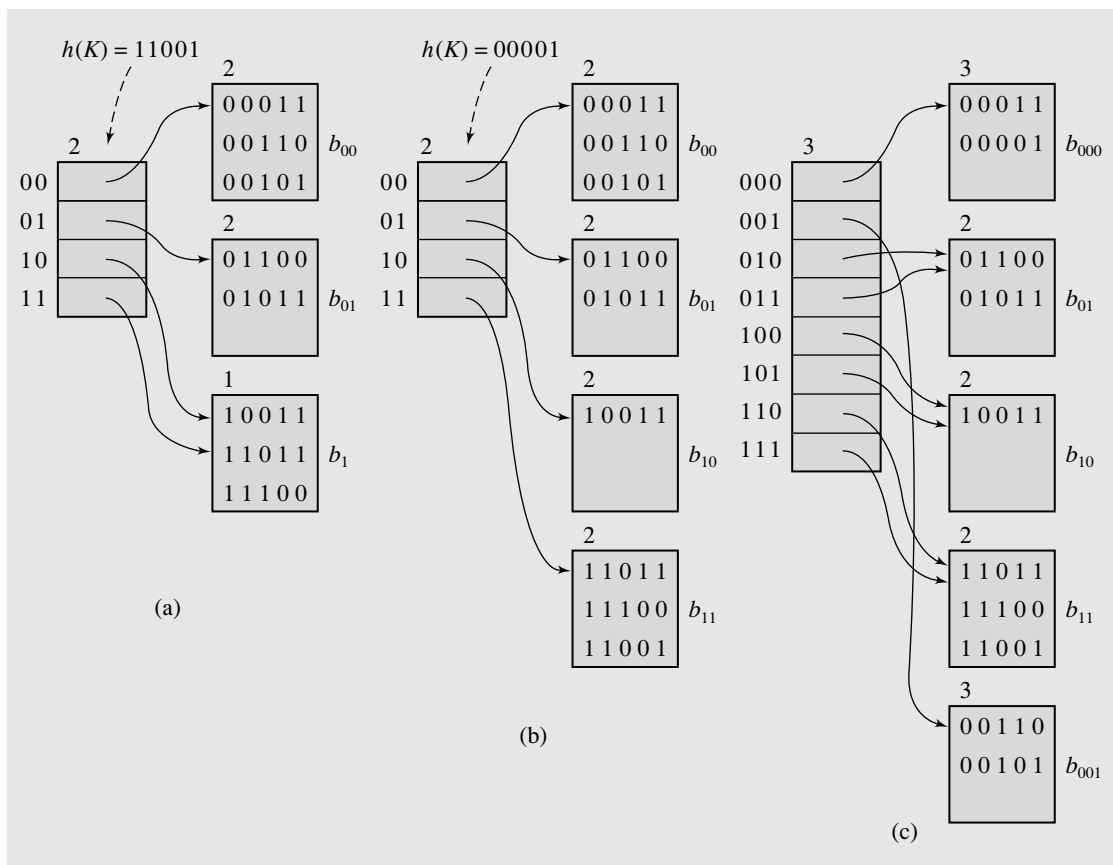
One directoryless technique is *virtual hashing*, defined as “any hashing which may dynamically change its hashing function” (Litwin, 1978). This change of hashing function compensates for the lack of a directory. An example of this approach is linear hashing (Litwin, 1980). In the following pages, one method from each category is discussed.

### 10.5.1 Extendible Hashing

Assume that a hashing technique is applied to a dynamically changing file composed of buckets, and each bucket can hold only a fixed number of items. Extendible hashing accesses the data stored in buckets indirectly through an index that is dynamically adjusted to reflect changes in the file. The characteristic feature of extendible hashing is the organization of the index, which is an expandable table.

A hash function applied to a certain key indicates a position in the index and not in the file (or table of keys). Values returned by such a hash function are called *pseudokeys*. In this way, the file requires no reorganization when data are added to it or deleted from it, because these changes are indicated in the index. Only one hash function  $h$  can be used, but depending on the size of the index, only a portion of the address  $h(K)$  is utilized. A simple way to achieve this effect is by looking at the address  $h(K)$  as a string of bits from which only the  $i$  leftmost bits can be used. The number  $i$  is called the *depth* of the directory. In Figure 10.13a, the depth is equal to two.

**FIGURE 10.13** An example of extendible hashing.



As an example, assume that the hash function  $h$  generates patterns of five bits. If this pattern is the string 01011 and the depth is two, then the two leftmost bits, 01, are considered to be the position in the directory containing the reference to a bucket in which the key can be found or into which it is to be inserted. In Figure 10.13, the values of  $h$  are shown in the buckets, but these values represent only the keys that are actually stored in these buckets.

Each bucket has a *local depth* associated with it that indicates the number of leftmost bits in  $h(K)$ . The leftmost bits are the same for all keys in the bucket. In Figure 10.13, the local depths are shown on top of each bucket. For example, the bucket  $b_{00}$  holds all keys for which  $h(K)$  starts with 00. More important, the local depth indicates whether the bucket can be accessed from only one location in the directory or from at least two. In the first case, when the local depth is equal to the depth of directory, it is necessary to change the size of the directory after the bucket is split in the case of overflow. When the local depth is smaller than the directory depth, splitting the bucket only requires changing half of the references pointing to this bucket so that they point to the newly created one. Figure 10.13b illustrates this case. After a key with  $h$ -value 11001 arrives, its two first bits (because depth = 2) direct it to the fourth position of the directory, from which it is sent to the bucket  $b_1$ , which contains keys whose  $h$ -value starts with 1. An overflow occurs, and  $b_1$  is split into  $b_{10}$  (the new name for the old bucket) and  $b_{11}$ . The local depths of these two buckets are set to two. The reference from position 11 points now to  $b_{11}$ , and the keys from  $b_1$  are redistributed between  $b_{10}$  and  $b_{11}$ .

The situation is more complex if overflow occurs in a bucket with a local depth equal to the depth of the directory. For example, consider the case when a key with  $h$ -value 00001 arrives at the table in Figure 10.13b and is hashed through position 00 (its first two bits) to bucket  $b_{00}$ . A split occurs, but the directory has no room for the reference to the new bucket. As a result, the directory is doubled in size so that its depth is now equal to three,  $b_{00}$  becomes  $b_{000}$  with an increased local depth, and the new bucket is  $b_{001}$ . All the keys from  $b_{00}$  are divided between the new buckets: Those whose  $h$ -value starts with 000 become elements of  $b_{000}$ ; the remaining keys, those with prefix 001, are put in  $b_{001}$ , as in Figure 10.13c. Also, all the slots of the new directory have to be set to their proper values by having  $newdirectory[2 \cdot i] = olddirectory[i]$  and  $newdirectory[2 \cdot i + 1] = olddirectory[i]$  for  $i$ 's ranging over positions of the *olddirectory*, except for the position referring to the bucket that just has been split.

The following algorithm inserts a record into a file using extendible hashing:

```

extendibleHashingInsert(K)
    bitPattern = h(K);
    p = directory[depth(directory) leftmost bits of bitPattern];
    if space is available in bucket  $b_d$  pointed to by p
        place K in the bucket;
    else split bucket  $b_d$  into  $b_{d0}$  and  $b_{d1}$ ;
        set local depth of  $b_{d0}$  and  $b_{d1}$  to depth( $b_d$ ) + 1;
        distribute records from  $b_d$  between  $b_{d0}$  and  $b_{d1}$ ;
        if depth( $b_d$ ) < depth(directory)
            update the half of the references which pointed to  $b_d$  to point to  $b_{d1}$ ;
        else double the directory and increment its depth;
            set directory entries to proper references;

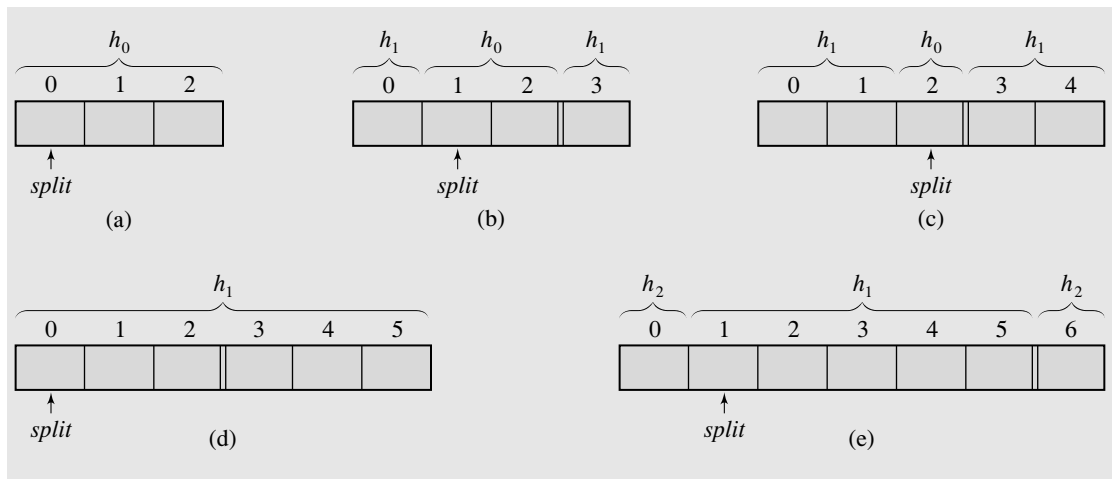
```

An important advantage of using extendible hashing is that it avoids a reorganization of the file if the directory overflows. Only the directory is affected. Because the directory in most cases is kept in main memory, the cost of expanding and updating it is very small. However, for large files of small buckets, the size of the directory can become so large that it may be put in virtual memory or explicitly in a file, which may slow down the process of using the directory. Also, the size of the directory does not grow uniformly, because it is doubled if a bucket with a local depth equal to the depth of the directory is split. This means that for large directories there will be many redundant entries in the directory. To rectify the problem of an overgrown directory, David Lomet proposed using extendible hashing until the directory becomes too large to fit into main memory. Afterward, the buckets are doubled instead of the directory, and the bits in the bit pattern  $h(K)$  that come after the first *depth* bits are used to distinguish between different parts of the bucket. For example, if *depth* = 3 and a bucket  $b_{10}$  has been quadrupled, its parts are distinguished with bit strings 00, 01, 10, and 11. Now, if  $h(K) = 10101101$ , the key  $K$  is searched for in the second portion, 01, of  $b_{101}$ .

### 10.5.2 Linear Hashing

Extendible hashing allows the file to expand without reorganizing it, but it requires storage space for an index. In the method developed by Witold Litwin, no index is necessary because new buckets generated by splitting existing buckets are always added in the same linear way, so there is no need to retain indexes. To this end, a reference *split* indicates which bucket is to be split next. After the bucket pointed to by *split* is divided, the keys in this bucket are distributed between this bucket and the newly created bucket, which is added to the end of the table. Figure 10.14 contains a sequence of initial splits in which  $TSize = 3$ . Initially, the reference *split* is zero. If the loading factor

**FIGURE 10.14** Splitting buckets in the linear hashing technique.



exceeds a certain level, a new bucket is created, keys from bucket zero are distributed between bucket zero and bucket three, and *split* is incremented. How is this distribution performed? If only one hash function is used, then it hashes keys from bucket zero to bucket zero before and after splitting. This means that one function is not sufficient.

At each level of splitting, linear hashing maintains two hash functions,  $h_{level}$  and  $h_{level+1}$ , such that  $h_{level}(K) = K \bmod (TSize \cdot 2^{level})$ . The first hash function,  $h_{level}$ , hashes keys to buckets that have not yet been split on the current level. The second function,  $h_{level+1}$ , is used for hashing keys to already split buckets. The algorithm for linear hashing is as follows:

```
initialize: split = 0; level = 0;
```

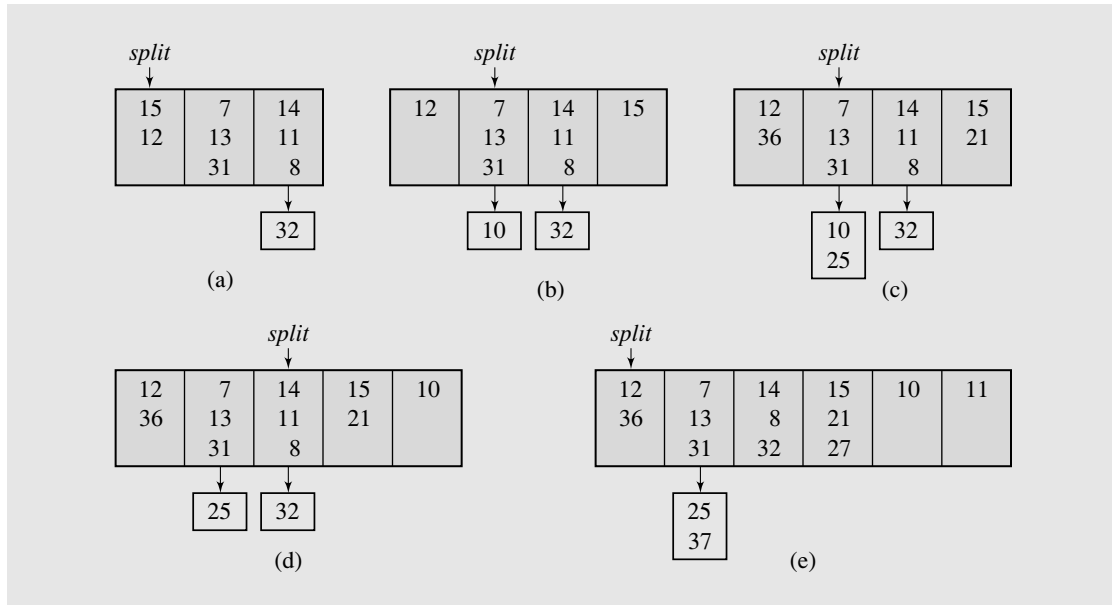
```
linearHashingInsert(K)
  if  $h_{level}(K) < split$  // bucket  $h_{level}(K)$  has been split
    hashAddress =  $h_{level+1}(K)$ ;
  else hashAddress =  $h_{level}(K)$ ;
  insert K in a corresponding bucket or an overflow area if possible;
  while the loading factor is high or K not inserted
    create a new bucket with index  $split + TSize \cdot 2^{level}$ ;
    redistribute keys from bucket  $split$  between buckets  $split$  and  $split + TSize \cdot 2^{level}$ ;
    split++;
  if  $split == TSize \cdot 2^{level}$  // all buckets on the current
    // level have been split;
    level++; // proceed to the next level
    split = 0;
  try to insert K if not inserted yet;
```

It may still be unclear when to split a bucket. Most likely, as the algorithm assumes, a threshold value of the loading factor is used to decide whether to split a bucket. This threshold has to be known in advance, and its magnitude is chosen by the program designer. To illustrate, assume that keys can be hashed to buckets in a file. If a bucket is full, the overflowing keys can be put on a linked list in an overflow area. Consider the situation in Figure 10.15a. In this figure,  $TSize = 3$ ,  $h_0(K) = K \bmod TSize$ ,  $h_1(K) = K \bmod 2 \cdot TSize$ . Let the size of the overflow area  $OSize = 3$ , and let the highest acceptable loading factor that equals the number of elements divided by the number of slots in the file and in the overflow area be 80 percent. The current loading factor in Figure 10.15a is 75 percent. If the key 10 arrives, it is hashed to location 1, but the loading factor increases to 83 percent. The first bucket is split and the keys are redistributed using function  $h_1$ , as in Figure 10.15b. Note that the first bucket had the lowest load of all three buckets, and yet it was the bucket that was split.

Assume that 21 and 36 have been hashed to the table (Figure 10.15c), and now 25 arrives. This causes the loading factor to increase to 87 percent, resulting in another split, this time the split of the second bucket, which results in the configuration shown in Figure 10.15d. After hashing 27 and 37, another split occurs, and Figure 10.15e illustrates the new situation. Because *split* reached the last value allowed on this level, it is assigned the value of zero, and the hash function to be used in subsequent hashing



**FIGURE 10.15** Inserting keys to buckets and overflow areas with the linear hashing technique.



is  $h_1$ , the same as before, and a new function,  $h_2$ , is defined as  $K \bmod 4 \cdot TSize$ . All of these steps are summarized in the following table:

$K$	$h(K)$	Number of Items	Number of Cells	Loading Factor	Split	Hash Functions
		9	9 + 3	9/12 = 75%	0	$K \bmod 3$ $K \bmod 6$
10	1	10	9 + 3	10/12 = 83%	0	$K \bmod 3$ $K \bmod 6$
		10	9 + 3	10/15 = 67%	1	$K \bmod 3$ $K \bmod 6$
21	3	11	12 + 3	11/15 = 73%	1	$K \bmod 3$ $K \bmod 6$
36	0	12	12 + 3	12/15 = 80%	1	$K \bmod 3$ $K \bmod 6$
25	1	13	12 + 3	13/15 = 87%	1	$K \bmod 3$ $K \bmod 6$
		13	12 + 3	13/18 = 72%	2	$K \bmod 3$ $K \bmod 6$
27	3	14	15 + 3	14/18 = 78%	2	$K \bmod 3$ $K \bmod 6$
37	1	15	15 + 3	15/18 = 83%	2	$K \bmod 3$ $K \bmod 6$
		15	18 + 3	15/21 = 71%	0	$K \bmod 6$ $K \bmod 12$

Note that linear hashing requires the use of some overflow area because the order of splitting is predetermined. In the case of files, this may mean more than one file access. This area can be explicit and different from buckets, but it can be introduced

somewhat in the spirit of coalesced hashing by utilizing empty space in the buckets (Mullin, 1981). In a directory scheme, on the other hand, an overflow area is not necessary, although it can be used.

As in a directory scheme, linear hashing increases the address space by splitting a bucket. It also redistributes the keys of the split bucket between the buckets that result from the split. Because no indexes are maintained in linear hashing, this method is faster and requires less space than previous methods. The increase in efficiency is particularly noticeable for large files.

## 10.6 HASHING IN `java.util`

### 10.6.1 `HashMap`

`HashMap` is an implementation of the interface `Map`. A map is a collection that holds pairs (key, value) or entries (another implementation, `TreeMap`, was discussed in Section 7.1.8). Class hierarchy in `java.util` for `HashMap` is as follows:

```
Object ⇒ AbstractMap ⇒ HashMap
```

A hash map is a collection of singly linked lists (buckets); that is, chaining is used as a collision resolution technique. Methods of the class `HashMap` are listed in Figure 10.16. An example program is shown in Figure 10.17. In the program, a hash map stores pairs (key, value), where a key is an object of type `Person` and a value is a string. The class `Person` contains definitions (in fact, redefinitions) of the methods `equals()` and `hashCode()`. The two methods have to work in unison, and should be defined so that if for two objects `ob1` and `ob2`, `ob1.equals(ob2)`, then their hash codes `ob1.hashCode()` and `ob2.hashCode()` are the same. For example, if `equals()` is not defined in `Person`, and so the inherited `equals()` would be used by methods of the hash map, then `containsKey()` would return false. To speed up the process of finding a hash value, the value is computed once and stored in an instance variable `hashCode`, which is used by `hashCode()` in its return statement.

Note that, in a hash map, both null values and null keys are permitted, as in

```
cities.put(null, "Nashville");
cities.put(new Person("Kay", 44), null);
```

However, afterwards, both these statements

```
cities.get(new Person("Kay", 44));
cities.get(new Person("Stan", 55));
```

return null. To distinguish the null that is an indicator of the fact that the value associated with a key is not in the hash map from the null that is the value associated with the key, the method `containsKey()` can be applied to the keys and, if it returns true, then null returned by `get()` is the value associated with the key.

**FIGURE 10.16** Methods in class `HashMap` including three inherited methods.

Method	Operation
<code>void clear()</code>	Remove all the objects from the hash map.
<code>Object clone()</code>	Return a copy of the hash map without cloning its elements.
<code>boolean containsKey(Object key)</code>	Return <code>true</code> if the hash map contains the object <code>key</code> .
<code>boolean containsValue(Object val)</code>	Return <code>true</code> if the hash map contains the object <code>val</code> .
<code>Set entrySet()</code>	Return a set containing all the pairs (key, value) in the hash map.
<code>boolean equals(Object ob)</code>	Return <code>true</code> if the current hash map and object <code>ob</code> are equal (inherited).
<code>int hashCode()</code>	Return the hash code for the hash map (inherited).
<code>Object get(Object key)</code>	Return the object associated with <code>key</code> .
<code>HashMap()</code>	Create an empty hash map with initial capacity equal to 16 and the load factor equal to .75.
<code>HashMap(int ic)</code>	Create an empty hash map with initial capacity <code>ic</code> and the load factor equal to .75; throw <code>IllegalArgumentException</code> if <code>ic &lt; 0</code> .
<code>HashMap(int ic, float lf)</code>	Create an empty hash map with initial capacity <code>ic</code> and the load factor <code>lf</code> ; throw <code>IllegalArgumentException</code> if <code>ic &lt; 0</code> or <code>lf ≤ 0</code> .
<code>HashMap(Map m)</code>	Create a hash map with copies of elements from map <code>m</code> ; throw <code>NullPointerException</code> if <code>m</code> is null.
<code>boolean isEmpty()</code>	Return <code>true</code> if the hash map contains no elements, <code>false</code> otherwise.
<code>Set keySet()</code>	Return a set containing all the keys of the hash map.
<code>Object put(Object key, Object val)</code>	Put the pair ( <code>key</code> , <code>val</code> ) in the hash map; return a value associated with <code>key</code> if there is any in the hash map, <code>null</code> otherwise.
<code>void putAll(Map m)</code>	Add objects from map <code>m</code> to the current hash map; throw <code>NullPointerException</code> if <code>m</code> is null.
<code>void rehash()</code>	A protected method to increase the capacity of the hashtable; the method is called automatically when the number of keys in the hashtable is greater than the product of the load factor and the current capacity.
<code>Object remove(Object key)</code>	Remove the pair ( <code>key</code> , corresponding value) from the hash map and return the value associated currently with <code>key</code> in the hash map.
<code>int size()</code>	Return the number of objects in the hash map.
<code>String toString()</code>	Return a string representation of the hash map that contains the string representation of all the elements (inherited).
<code>Collection values()</code>	Return a collection with all the values contained in the hash map.

**FIGURE 10.17** Demonstrating the operation of the methods in class `HashMap`.

```
import java.io.*;
import java.util.HashMap;

class Person {
    private String name;
    int age;
    private int hashCode = 0;
    public Person(String n, int a) {
        name = n; age = a;
        for (int i = 0; i < name.length(); i++)
            hashCode += name.charAt(i);
    }
    public Person() {
        this("",0);
    }
    public boolean equals(Object p) {
        return name.equals(((Person)p).name);
    }
    public int hashCode() {
        return hashCode;
    }
    public String toString() {
        return "(" + name + "," + age + ")";
    }
}

class TestHashMap {
    public static void main(String[] a) {
        HashMap cities = new HashMap();
        cities.put(new Person("Gregg",25),"Pittsburgh");
        cities.put(new Person("Ann",30),"Boston");
        cities.put(new Person("Bill",20),"Belmont");
        System.out.println(cities);
        // {(Ann,30)=Boston, (Gregg,25)=Pittsburgh, (Bill,20)=Belmont}
        cities.put(new Person("Gregg",30),"Austin");
        System.out.println(cities);
        // {(Ann,30)=Boston, (Gregg,25)=Austin, (Bill,20)=Belmont}
        System.out.println(cities.containsKey(new Person("Ann",30)));
        // true
        System.out.println(cities.containsValue("Boston"));
        // true
        System.out.println(cities.size()); // 3
    }
}
```

**FIGURE 10.17** (continued)

```

System.out.println(cities.get(new Person("Ann",30))); // Boston
System.out.println(cities.entrySet());
// [(Ann,30)=Boston, (Gregg,25)=Austin, (Bill,20)=Belmont]
System.out.println(cities.values());
// [Boston, Austin, Belmont]
System.out.println(cities.keySet());
// [(Ann,30), (Gregg,25), (Bill,20)]
System.out.println(cities.remove(new Person("Bill",20)));
// Belmont
System.out.println(cities);
// [(Ann,30), (Gregg,25)]
cities.put(null,"Nashville");
cities.put(new Person("Kay",44),null);
System.out.println(cities);
// [(Ann,30)=Boston, (Gregg,25)=Austin, (Kay,44)=null,
// null=Nashville]
System.out.println(cities.get(new Person("Kay",44)));
// null
System.out.println(cities.get(new Person("Stan",55)));
// null
System.out.println(cities.containsKey(new Person("Kay",44)));
// true
System.out.println(cities.containsKey(new Person("Stan",55)));
// false
    }
}

```

## 10.6.2 HashSet

A set—that is, an object that stores unique elements—was already implemented as `TreeSet` (Section 7.1.8); `HashSet` is another implementation of a set. The methods of the `HashSet` class are listed in Figure 10.18.

Class hierarchy in `java.util` for `HashSet` is as follows:

```
Object ⇒ AbstractCollection ⇒ AbstractSet ⇒ HashSet
```

that is, interfaces for `HashSet` are different than for `HashMap`; however, `HashSet` is implemented in terms of `HashMap` (which is similar to the relation between `TreeSet` and `TreeMap`). For example, the constructor `HashSet()` is defined as

```

public HashSet() {
    map = new HashMap();
}

```

**FIGURE 10.18** Methods in class `HashSet` including some inherited methods.

Method	Operation
<code>boolean add(Object ob)</code>	Add <code>ob</code> to the hash set if it is not already there; return <code>true</code> if <code>ob</code> was added.
<code>boolean addAll(Collection c)</code>	Add all the elements from the collection <code>c</code> to the hash set; return <code>true</code> if the hash set was modified ( ); throw <code>NullPointerException</code> if <code>c</code> is null (inherited).
<code>void clear()</code>	Remove all the objects from the hash set.
<code>Object clone()</code>	Return a copy of the hash set without cloning its elements.
<code>boolean contains(Object ob)</code>	Return <code>true</code> if the hash set contains the object <code>ob</code> .
<code>boolean containsAll(Collection c)</code>	Return <code>true</code> if the hash set contains all elements in the collection <code>c</code> ; throw <code>NullPointerException</code> if <code>c</code> is null (inherited).
<code>boolean equals(Object ob)</code>	Return <code>true</code> if the current hash set and object <code>ob</code> are equal (inherited).
<code>int hashCode()</code>	Return the hash code for the hash set (inherited).
<code>HashSet()</code>	Create an empty hash set with initial capacity equal to 16 and the load factor equal to .75.
<code>HashSet(int ic)</code>	Create an empty hash set with initial capacity <code>ic</code> and the load factor equal to .75; throw <code>IllegalArgumentException</code> if <code>ic &lt; 0</code> .
<code>HashSet(int ic, float lf)</code>	Create an empty hash set with initial capacity <code>ic</code> and the load factor <code>lf</code> ; throw <code>IllegalArgumentException</code> if <code>ic &lt; 0</code> or <code>lf ≤ 0</code> .
<code>HashSet(Collection c)</code>	Create a hash set with copies of elements from <code>c</code> ; throw <code>NullPointerException</code> if <code>c</code> is null.
<code>boolean isEmpty()</code>	Return <code>true</code> if the hash set contains no elements, <code>false</code> otherwise.
<code>boolean iterator()</code>	Return an iterator over the elements in the hash set; the iteration order can change over time.
<code>boolean remove(Object ob)</code>	Remove <code>ob</code> from the hash set and return <code>true</code> if <code>ob</code> was in the hash set.
<code>boolean removeAll(Collection c)</code>	Remove from the hash set all elements contained in collection <code>c</code> ; return <code>true</code> if any element was removed; throw <code>NullPointerException</code> if <code>c</code> is null (inherited).
<code>boolean retainAll(Collection c)</code>	Remove from the hash set all elements that are not in the collection <code>c</code> ; return <code>true</code> if any element was removed; throw <code>NullPointerException</code> if <code>c</code> is null (inherited).
<code>Object[] toArray()</code>	Copy all elements from the hash set to a newly created array and return the array (inherited).

**FIGURE 10.18** (continued)

<code>Object[] toArray(Object a[])</code>	Copy all elements from the hash set to the array <code>a</code> if <code>a</code> is large enough or to a newly created array and return the array; throw <code>ArrayStoreException</code> if the class type of any element in the hash set is not the same as or does not extend the class type of <code>a</code> ; throw <code>NullPointerException</code> if <code>a</code> is null (inherited).
<code>int size()</code>	Return the number of objects in the hash set.
<code>String toString()</code>	Return a string representation of the hash set that contains the string representation of all the elements (inherited).

To account in this implementation for the value of each entry in the underlying map, a dummy constant is used:

```
private static final Object dummy = new Object();
```

and then other methods are defined by the methods for the underlying map, possibly using `dummy`; for example,

```
public boolean add(Object ob) {
    return map.put(ob,dummy) == null;
}
```

Some of the operations are illustrated in Figure 10.19. Note that out of five objects in the array `p`, only four are inserted in `pSet`, because the objects `Person("Gregg", 25)` and `Person("Gregg", 30)` are considered to be the same on account of the way the method `equals()` is defined in the class `Person`.

**FIGURE 10.19** Demonstrating the operation of the methods in class `HashSet`.

```
import java.io.*;
import java.util.*;

class Person implements Comparable {
    private String name;
    public int age;
    private int hashCode = 0;
    public Person(String n, int a) {
        name = n; age = a;
        for (int i = 0; i < name.length(); i++)
            hashCode += name.charAt(i);
    }
}
```

*Continues*

**FIGURE 10.19** (continued)

```
    }
    public Person() {
        this("",0);
    }
    public boolean equals(Object p) {
        return name.equals(((Person)p).name);
    }
    public int compareTo(Object p) {
        return name.compareTo(((Person)p).name);
    }
    public int hashCode() {
        return hashCode;
    }
    public String toString() {
        return "(" + name + "," + age + ")";
    }
}

class TestHashSet {
    public static void main(String[] ar) {
        HashSet hashset1 = new HashSet();
        hashset1.add(new Integer(40));
        hashset1.add(new Integer(60));
        System.out.println(hashset1);           // [40, 60]
        hashset1.add(new Integer(50));
        System.out.println(hashset1);           // [40, 50, 60]
        hashset1.add(new Integer(50));
        System.out.println(hashset1);           // [40, 50, 60]
        System.out.println(hashset1.contains(new Integer(50))); // true
        System.out.println(hashset1.contains(new Integer(70))); // false
        HashSet hashset2 = new HashSet();
        hashset2.add(new Integer(30));
        hashset2.add(new Integer(40));
        hashset2.add(new Integer(50));
        System.out.println(hashset2);           // [30, 40, 50]
        hashset1.addAll(hashset2);
        // union: [40, 50, 60] and [30, 40, 50] ==> [30, 40, 50, 60]
        System.out.println(hashset1);           // [30, 40, 50, 60]
        hashset1.remove(new Integer(30));
        System.out.println(hashset1);           // [40, 50, 60]
        hashset1.retainAll(hashset2);           // [40, 50]
        // intersection: [40, 50, 60] and [30, 40, 50] ==> [40, 50]
        System.out.println(hashset1);           // [40, 50]
```



**FIGURE 10.19** (continued)

```

        HashSet1.add(new Integer(60));    // [40, 50, 60]
        HashSet1.removeAll(HashSet2);
        // difference: [40, 50, 60] and [30, 40, 50] ==> [60]
        System.out.println(HashSet1);    // [60]
        HashSet1.add(null);
        System.out.println(HashSet1);    // [60, null]

        HashSet pSet = new HashSet();
        Person[] p = {new Person("Gregg",25), new Person("Ann",30),
                     new Person("Bill",20), new Person("Gregg",35),
                     new Person("Kay",30)};
        for (int i = 0; i < p.length; i++)
            pSet.add(p[i]);
        System.out.println(pSet);
        // [(Ann,30), (Gregg,25), (Kay,30), (Bill,20)]
        java.util.Iterator it = pSet.iterator();
        ((Person)it.next()).age = 50;
        System.out.println(pSet);
        // [(Ann,50), (Gregg,25), (Kay,30), (Bill,20)]
        pSet.add(new Person("Craig",40));
        System.out.println(pSet);
        // [(Ann,50), (Gregg,25), (Kay,30), (Craig,40), (Bill,20)]
        for (int i = 0; i < p.length; i++)
            System.out.println(p[i] + " " + pSet.contains(p[i]));
        // (Gregg,25) true
        // (Ann,50) true
        // (Bill,20) true
        // (Gregg,35) true
        // (Kay,30) true
        // Using an array to sort elements in the HashSet:
        Person[] pArray = (Person[]) pSet.toArray(new Person[0]);
        for (int i = 0; i < p.length; i++)
            System.out.print(pArray[i] + " ");
        System.out.println();
        // (Ann,50) (Gregg,25) (Kay,30) (Craig,40) (Bill,20)
        Arrays.sort(pArray);
        for (int i = 0; i < p.length; i++)
            System.out.print(pArray[i] + " ");
        System.out.println();
        // (Ann,50) (Bill,20) (Craig,40) (Gregg,25) (Kay,30)
        System.out.println(pSet);
    }
}

```

To sort elements in the hash set, the elements are first copied to an array `pArray` with the `toArray()` method, and then a sorting method from class `Array` is applied to `pArray`. The elements are sorted by name according to the `compareTo()` method defined in class `Person` that implements the `Comparable` interface precisely to enable such sorting (see `Person` in Figure 9.17).

### 10.6.3 Hashtable

Another implementation of the interface `Map` is `Hashtable`, which is roughly equivalent to `HashMap` except that it is synchronized and does not permit null values with methods to operate on hash tables. The class `Hashtable` is considered a legacy class, just like the class `Vector`. Class hierarchy in `java.util` is as follows:

```
Object ⇒ Dictionary ⇒ Hashtable
```

`Hashtable` methods are listed in Figure 10.20.

**FIGURE 10.20** Methods of the class `Hashtable` including three inherited methods.

Method	Operation
<code>void clear()</code>	Remove all the objects from the hashtable.
<code>Object clone()</code>	Return a copy of the hashtable without cloning its elements.
<code>boolean contains(Object val)</code>	Return <code>true</code> if the hashtable contains the object <code>val</code> ; throw <code>NullPointerException</code> if <code>val</code> is null.
<code>boolean containsKey(Object key)</code>	Return <code>true</code> if the hashtable contains the object <code>key</code> ; throw <code>NullPointerException</code> if <code>key</code> is null.
<code>boolean containsValue(Object val)</code>	Return <code>true</code> if the hashtable contains the object <code>val</code> ; throw <code>NullPointerException</code> if <code>val</code> is null.
<code>Enumeration elements()</code>	Return an enumeration of the values in the hashtable.
<code>Set entrySet()</code>	Return a set containing all the pairs (key, value) in the hashtable.
<code>boolean equals(Object ob)</code>	Return <code>true</code> if the current hashtable and object <code>ob</code> are equal.
<code>Object get(Object key)</code>	Return the object associated with <code>key</code> ; throw <code>NullPointerException</code> if <code>key</code> is null.
<code>int hashCode()</code>	Return the hash code for the hashtable.
<code>Hashtable()</code>	Create an empty hashtable with initial capacity equal to 11 and the load factor equal to <code>.75</code> .
<code>Hashtable(int ic)</code>	Create an empty hashtable with initial capacity <code>ic</code> and the load factor equal to <code>.75</code> ; throw <code>IllegalArgumentException</code> if <code>ic &lt; 0</code> .

**FIGURE 10.20** (continued)

<code>Hashtable(int ic, float lf)</code>	Create an empty hashtable with initial capacity <code>ic</code> and the load factor <code>lf</code> ; throw <code>IllegalArgumentException</code> if <code>ic &lt; 0</code> or <code>lf ≤ 0</code> .
<code>Hashtable(Map m)</code>	Create a hashtable with copies of elements from map <code>m</code> ; throw <code>NullPointerException</code> if <code>m</code> is null.
<code>boolean isEmpty()</code>	Return <code>true</code> if the hashtable contains no elements, <code>false</code> otherwise.
<code>Enumeration keys()</code>	Return an enumeration containing all the keys of the hashtable.
<code>Set keySet()</code>	Return a set containing all the keys of the hashtable.
<code>Object put(Object key, Object val)</code>	Put the pair ( <code>key</code> , <code>val</code> ) in the hashtable; return a value associated with <code>key</code> if there is any in the hashtable, <code>null</code> otherwise; throw <code>NullPointerException</code> if <code>key</code> or <code>val</code> is null.
<code>void putAll(Map m)</code>	Add objects from map <code>m</code> to the current hashtable; throw <code>NullPointerException</code> if <code>m</code> is null.
<code>void rehash()</code>	A protected method to increase the capacity of the hashtable; the method is called automatically when the number of keys in the hashtable is greater than the product of the load factor and the current capacity.
<code>Object remove(Object key)</code>	Remove the pair ( <code>key</code> , corresponding value) from the hashtable and return the value associated currently with <code>key</code> in the hashtable; throw <code>NullPointerException</code> if <code>key</code> is null.
<code>int size()</code>	Return the number of objects in the hashtable.
<code>String toString()</code>	Return a string representation of the hashtable that contains the string representation of all the objects.
<code>Collection values()</code>	Return a <code>Collection</code> object with all the values contained in the hashtable.

`Hashtable` objects are expandable hash tables that automatically adjust the capacity of the table if the load factor is surpassed. The default load factor equals `.75` and the default table capacity equals `11`, which is a prime number. The user can choose another load factor and capacity when creating a `Hashtable` object with one of the four constructors. The program in Figure 10.21 demonstrates the operation of some of the `Hashtable` methods. A new entry is inserted in a bucket of the hash table indicated by the `hashCode()` method of the key object that is the first parameter of the method `put()`. The value generated by `hashCode()` is then used internally by the hash table object to produce an actual hash value.

**FIGURE 10.21** A program demonstrating operations of the `Hashtable` methods.

```
import java.io.*;
import java.util.*;

class Person {
    private String name;
    public int age;
    public Person(String s, int i) {
        name = s; age = i;
    }
    Person() {
        this("",0);
    }
    public String toString() {
        return "(" + name + "," + age + ")";
    }
    public boolean equals(Object p) {
        return name.equals(((Person)p).name);
    }
}

class SSN {
    private int value;
    private hashCode;
    public SSN(int i) {
        value = i;
        hashCode = (value & 0x0000ffff) + (value >>> 16)
    }
    public boolean equals(Object ob) {
        return value == ((SSN)ob).value;
    }
    public int hashCode() {
        return hashCode;
    }
    public String toString() {
        return "" + value;
    }
}

class testHashtable {
    static void print(Iterator it) {
        if (it.hasNext()) {
```

**FIGURE 10.21** (continued)

```

        System.out.print(it.next());
        while (it.hasNext())
            System.out.print(", " + it.next());
    }
    System.out.println();
}
static void print(Enumeration e) {
    if (e.hasMoreElements()) {
        System.out.print(e.nextElement());
        while (e.hasMoreElements())
            System.out.print(", " + e.nextElement());
    }
    System.out.println();
}
public static void main(String[] ar) {
    Hashtable hashTable1 = new Hashtable(4);
    hashTable1.put(new Integer(123456789),new Person("Larry",25));
    hashTable1.put(new Integer(111111111),new Person("Kathy",30));
    System.out.println(hashTable1);
    // {111111111=(Kathy,30), 123456789=(Larry,25)}
    hashTable1.put(new Integer(222222222),new Person("Kathy",20));
    System.out.println(hashTable1);
    // {111111111=(Kathy,30), 222222222=(Kathy,20), 123456789=(Larry,25)}
    print(hashTable1.entrySet().iterator());
    // 111111111=(Kathy,30), 222222222=(Kathy,20), 123456789=(Larry,25)
    print(hashTable1.keySet().iterator());
    // 111111111, 222222222, 123456789
    print(hashTable1.elements());
    // (Kathy,30), (Kathy,20), (Larry,25)
    print(hashTable1.keys());
    // 111111111, 222222222, 123456789
    print(hashTable1.values().iterator());
    // (Kathy,30), (Kathy,20), (Larry,25)
    Iterator it = hashTable1.values().iterator();
    ((Person)it.next()).age = 28;
    System.out.println(hashTable1);
    // {111111111=(Kathy,28), 222222222=(Kathy,20), 123456789=(Larry,25)}
    hashTable1.put(new Integer(111111111),new Person("Jerry",20));
    System.out.println(hashTable1);
    // {111111111=(Jerry,20), 222222222=(Kathy,20), 123456789=(Larry,25)}
    hashTable1.put(new Integer(111111113),new Person("Frank",30));
}

```

*Continues*

**FIGURE 10.21** (continued)

```

System.out.println(hashTable1);
// {111111113=(Frank,30), 123456789=(Larry,25), 222222222=(Kathy,20),
// 111111111=(Jerry,20)}
System.out.println(hashTable1.get(new Integer(111111111))); // (Jerry,20)
System.out.println(hashTable1.contains(new Person("Jerry",20))); // true
System.out.println(hashTable1.containsValue(new Person("Jerry",20))); // true
System.out.println(hashTable1.remove(new Integer(111111111))); // (Jerry,20)
System.out.println(hashTable1);
// {222222222=(Kathy,20), 123456789=(Larry,25)}

Hashtable hashTable2 = new Hashtable();
hashTable2.put(new SSN(123456789),new Person("Larry",28));
hashTable2.put(new SSN(111111111),new Person("Kathy",30));
System.out.println(hashTable2);
// {111111111=(Kathy,30), 123456789=(Larry,28)}
hashTable2.put(new SSN(222222222),new Person("Kathy",20));
System.out.println(hashTable2);
// {222222222=(Kathy,20), 111111111=(Kathy,30), 123456789=(Larry,28)}
hashTable2.put(new SSN(111111111),new Person("Jerry",25));
System.out.println(hashTable2);
// {222222222=(Kathy,20), 111111111=(Jerry,25), 123456789=(Larry,28)}
hashTable2.put(new SSN(111111113),new Person("Frank",30));
System.out.println(hashTable2);
// {222222222=(Kathy,20), 111111113=(Frank,30), 111111111=(Jerry,25),
// 123456789=(Larry,28)}
}
}

```

An attempt to add an entry with the same key as an existing entry results in replacing the value of the existing entry with the value of the entry being added. At any time, methods `keySet()` and `entrySet()` can be applied to generate a set of keys and a set of entries in the table. The set generated with `entrySet()` includes objects of type `Map.Entry`, and thus the methods from the `Map.Entry` interface can be applied to this set (see Figure 7.34). All keys of the hash table can also be included in one enumeration object with the method `keys()` and all entries in one enumeration object with `values()`.

The object `hashTable1` in Figure 10.21 is declared to have an initial capacity of 4, so that after adding the fourth object to the table, the default load factor of 75 percent is exceeded and thus the method `rehash()` is automatically invoked. Note that after adding new elements when the load factor is not exceeded, the new element is put in one of the existing buckets of the table. Printing the table shows that some of

the old elements retain their relative order. But after adding the fourth object, which is `Person("Frank", 30)`, the elements of the table are reordered by applying an adjusted hash function to all the elements and hashing them to the new table of double size plus one.

The `hashCode()` method applied for `hashTable1` is a built-in method of the `Integer()` class that simply returns the integer for which an `Integer` object is created. The user can redefine this method, and, in fact, must redefine this method in user-defined types. If the method is not redefined, then `hashCode()` inherited from the class `Object` is applied, which returns the address of a particular object. As an example, consider the class `SSN` which, if it were possible, should be an extension of `Integer()`, but the latter is a final class, so its extension cannot be produced. `SSN()`'s `hashCode()` generates a hash code that is the sum of the first two bytes constituting an integer and the last two bytes. For example, the hash code for integer `0x12345678` equals  $0x1234 + 0x5678 = 0x68ac = 26,796$ .

## 10.7

### CASE STUDY: HASHING WITH BUCKETS

The most serious problem to be solved in programs that rely on a hash function to insert and retrieve items from an undetermined body of data is resolving collision. Depending on the technique, allowing deletion of items from the table can significantly increase the complexity of the program. In this case study, a program is developed that allows the user to insert and delete elements from the file `names` interactively. This file contains names and phone numbers, and is initially ordered alphabetically. At the end of the session, the file is ordered with all updates included. To that end, the `outfile` is used throughout the execution of the program. `outfile` is the file of buckets initialized as empty. Elements that cannot be hashed to the corresponding bucket in this file are stored in the file `overflow`. At the end of the session both files are combined and sorted to replace the contents of the original file `names`.

The `outfile` is used here as the hash table. First, this file is prepared by filling it with `tableSize * bucketSize` empty records (one record is simply a certain number of bytes). Next, all entries of names are transferred to `outfile` to buckets indicated by the hash function. This transfer is performed by the method `insertion()`, which includes the hashed item in the bucket indicated by the value computed by the method `hash()` or in `overflow` if the bucket is full. In the latter case, `overflow` is searched from the beginning, and if a position occupied by a deleted record is found, the overflow item replaces it. If the end of `overflow` is reached, the item is put at the end of this file.

After initializing `outfile`, a menu is displayed and the user chooses to insert a new record, delete an old one, or exit. For insertion, the same method is used as before. No duplicates are allowed. When the user wants to delete an item, the hash function is used to access the corresponding bucket, and the linear search of positions in the bucket is performed until the item is found, in which case the deletion marker “#” is written over the first character of the item in the bucket. However, if the item is not found and the end of the bucket is reached, the search continues sequentially in `overflow` until either the item is found and marked as deleted or the end of the file is encountered.

If the user chooses to exit, the undeleted entries of `overflow` are transferred to `outfile`, and all undeleted entries of `outfile` are sorted using an external sort. To that end, quicksort is applied both to `outfile` and to an array `positions[ ]`, which contains the addresses of entries in `outfile`. For comparison, the entries in `outfile` can be accessed, but the elements in `positions[ ]` are moved, not the elements of `outfile`.

After this indirect sorting is accomplished, the data in `outfile` have to be put in alphabetical order. This is accomplished by transferring entries from `outfile` to `sorted` using the order indicated in `positions[ ]`; that is, by going down the array and retrieving the entry in `outfile` through the address stored in the currently accessed cell. After transferring `outfile` to `unsorted`, `names` is deleted and `sorted` is renamed `names`.

Here is an example. If the contents of the original file are

```
Adam 123-4567      Brenda 345-5352      Brendon 983-7373
Charles 987-1122   Jeremiah 789-4563    Katherine 823-1573
Patrick 757-4532   Raymond 090-9383    Thorsten 929-6632
```

the hashing generates the `outfile`:

```
Katherine 823-1573 |*****||
Adam 123-4567      |Brenda 345-5352   ||
Raymond 090-9383  |Thorsten 929-6632 ||
```

and the file overflow:

```
Brendon 983-7373 |Charles 987-1122  ||
Jeremiah 789-4563 |Patrick 757-4532  ||
```

(The vertical bars are *not* included in the file; one bar divides the records in the same bucket, and two bars separate different buckets.)

After inserting `Carol 654-6543` and deleting `Brenda 345-5352` and `Jeremiah 789-4563`, the file's contents are:

`outfile`:

```
Katherine 823-1573 |Carol 654-6543    ||
Adam 123-4567      |#renda 345-5352   ||
Raymond 090-9383  |Thorsten 929-6632 ||
```

and overflow:

```
Brendon 983-7373 |Charles 987-1122  ||
#eremiah 789-4563 |Patrick 757-4532  ||
```

A subsequent insertion of `Maggie 733-0983` and deletion of `Brendon 983-7373` changes only `overflow`:

```
#rendon 983-7373 |Charles 987-1122  ||
Maggie 733-0983  |Patrick 757-4532  ||
```



After the user chooses to exit, undeleted records from `overflow` are transferred to `outfile`, which now includes:

```
Katherine 823-1573 |Carol 654-6543  ||
Adam 123-4567     |#renda 345-5352  ||
Raymond 090-9383 |Thorsten 929-6632 ||
Charles 987-1122  |Maggie 733-0983  ||
Patrick 757-4532  |
```

This file is sorted and the outcome is:

```
Adam 123-4567     |Carol 654-6543  ||
Charles 987-1122  |Katherine 823-1573 ||
Maggie 733-0983  |Patrick 757-4532  ||
Raymond 090-9383 |Thorsten 929-6632 ||
```

Figure 10.22 contains the code for this program.

**FIGURE 10.22** Implementation of hashing using buckets.

```
import java.io.*;
import java.io.File;

public class FileHashing {
    private final int bucketSize = 2, tableSize = 3, strLen = 20;
    private final int recordLen = strLen;
    private final byte empty = '*', delMarker = '#';
    private long[] positions;
    private InputStreamReader isr = new InputStreamReader(System.in);
    private BufferedReader buffer = new BufferedReader(isr);
    private RandomAccessFile outfile;
    private RandomAccessFile sorted;
    private RandomAccessFile overflow;
    public FileHashing() {
    }

    private void print(byte[] s) { // print a byte array;
        for(int k = 0; k < s.length; k++)
            System.out.print((char)s[k]);
    }

    private long hash(byte[] s) {
        long xor = 0, pack;
        int i, j, slength; // exclude trailing blanks:
        for (slength = s.length; s[slength-1] == ' '; slength--);
```

*Continues*

**FIGURE 10.22** *(continued)*

```

    for (i = 0; i < slength; ) {
        for (pack = j = 0; ; j++, i++) {
            pack |= (long) s[i]; // include s[i] in the rightmost
            if (j == 3 || i == slength - 1) { // byte of pack;
                i++;
                break;
            }
            pack <<= 8;
        } // xor at one time 8 bytes from s;
        xor ^= pack; // last iteration may put less
    } // than 8 bytes in pack;
    return (xor % tableSize) * bucketSize * recordLen;
} // return byte position of home bucket for s;

private byte[] getName() throws IOException {
    System.out.print("Enter a name & phone#: ");
    String s = buffer.readLine();
    for (int i = s.length(); i < recordLen; i++)
        s += ' ';
    return s.getBytes(); // s => line
}

private int comparesTo(byte[] s1, byte[] s2) { // same length
    for (int i = 0; i < s1.length; i++) // of s1 and s2
        if (s1[i] != s2[i]) // is assumed;
            return s1[i] - s2[i];
    return 0;
}

private void insert() throws IOException {
    insertion(getName());
}

private void insertion(byte[] line) throws IOException {
    byte[] name = new byte[recordLen];
    boolean done = false, inserted = false;
    int counter = 0;
    long address = hash(line);
    outfile.seek(address);
    while (!done && outfile.read(name) != -1) {
        if (name[0] == empty || name[0] == delMarker) {
            outfile.seek(address+counter*recordLen);

```

**FIGURE 10.22** (continued)

```

        outfile.write(line);
        done = inserted = true;
    }
    else if (comparesTo(name,line) == 0) {
        print(line);
        System.out.println(" is already in the file");
        return;
    }
    else counter++;
    if (counter == bucketSize)
        done = true;
    else outfile.seek(address+counter*recordLen);
}
if (!inserted) {
    done = false;
    counter = 0;
    overflow.seek(0);
    while (!done && overflow.read(name) != -1) {
        if (name[0] == delMarker)
            done = true;
        else if (comparesTo(name,line) == 0) {
            print(line);
            System.out.println(" is already in the file");
            return;
        }
        else counter++;
    }
    if (done)
        overflow.seek(counter*recordLen);
    else overflow.seek(overflow.length());
    overflow.write(line);
}
}

private void delete() throws IOException {
    byte[] line = getName();
    long address = hash(line);
    outfile.seek(address);
    int counter = 0;
    boolean done = false, deleted = false;
    byte[] name = new byte[recordLen];

```

*Continues*

**FIGURE 10.22** (continued)

```
while (!done && outfile.read(name) != -1) {
    if (comparesTo(line,name) == 0) {
        outfile.seek(address+counter*recordLen);
        outfile.write(delMarker);
        done = deleted = true;
    }
    else counter++;
    if (counter == bucketSize)
        done = true;
    else outfile.seek(address+counter*recordLen);
}
if (!deleted) {
    done = false;
    counter = 0;
    overflow.seek(0);
    while (!done && overflow.read(name) != -1) {
        if (comparesTo(line,name) == 0) {
            overflow.seek(counter*recordLen);
            overflow.write(delMarker);
            done = deleted = true;
        }
        else counter++;
        overflow.seek(counter*recordLen);
    }
}
if (!deleted) {
    print(line);
    System.out.println(" is not in database");
}
}

private void swap(long[] arr, int i, int j) {
    long tmp = arr[i]; arr[i] = arr[j]; arr[j] = tmp;
}

private int partition(int low, int high) throws IOException {
    byte[] rec = new byte[recordLen];
    byte[] pivot = new byte[recordLen];
    int i, lastSmall;
    swap(positions,low,(low+high)/2);
    outfile.seek(positions[low]*recordLen);
    outfile.read(pivot);
```

**FIGURE 10.22** (continued)

```

        for (lastSmall = low, i = low+1; i <= high; i++) {
            outfile.seek(positions[i]*recordLen);
            outfile.read(rec);
            if (comparesTo(rec,pivot) < 0) {
                lastSmall++;
                swap(positions,lastSmall,i);
            }
        }
        swap(positions,low,lastSmall);
        return lastSmall;
    }

    private void sort(int low, int high) throws IOException {
        if (low < high) {
            int pivotLoc = partition(low, high);
            sort(low, pivotLoc-1);
            sort(pivotLoc+1, high);
        }
    }

    private void sortFile() throws IOException {
        byte[] rec = new byte[recordLen];
        sort(1,(int)positions[0]); // positions[0] contains the # of elements;
        for (int i = 1; i <= positions[0]; i++) { // put data from
            outfile.seek(positions[i]*recordLen); // outfile in sorted order
            outfile.read(rec);
            sorted.write(rec); // in file sorted;
        }
    }

    // data from overflow file and outfile are all stored in outfile and
    // prepared for external sort by loading positions of the data to an array;

    private void combineFiles() throws IOException {
        byte[] rec = new byte[recordLen];
        int counter = bucketSize*tableSize;
        outfile.seek(outfile.length());
        overflow.seek(0);
        while (overflow.read(rec) != -1) { // transfer from
            if (rec[0] != delMarker) { // overflow to outfile only
                counter++; // valid (undeleted) items;
            }
        }
    }

```

*Continues*

**FIGURE 10.22** (continued)

```

        outfile.write(rec);
    }
}
positions = new long[counter+1];
outfile.seek(0);          // load to the array positions
int arrCnt = 1;          // of valid data stored in output file;
for (int i = 0; i < counter; i++) {
    outfile.seek(i*recordLen);
    outfile.read(rec);
    if (rec[0] != empty && rec[0] != delMarker)
        positions[arrCnt++] = i;
}
positions[0] = --arrCnt; // store the number of data in position 0;
}

public void processFile(String fileName) {
    char command = '1';
    byte[] line = new byte[recordLen];
    String commandLine;
    try {
        (new File(".\\", "outfile")).delete();
        (new File(".\\", "overflow")).delete();
        (new File(".\\", "sorted")).delete();
        RandomAccessFile fIn = new RandomAccessFile(fileName, "rw");
        outfile = new RandomAccessFile("outfile", "rw");
        sorted = new RandomAccessFile("sorted", "rw");
        overflow = new RandomAccessFile("overflow", "rw");
        for (int i = 1; i <= tableSize*bucketSize*recordLen; i++)
            outfile.write(empty);          // initialize outfile;
        while (fIn.read(line) != -1)      // load fIn to outfile;
            insertion(line);
        while (command != '3') {
            System.out.print("Enter your choice "
                + "(1. insert, 2. delete, 3. exit): ");
            commandLine = buffer.readLine();
            command = commandLine.charAt(0);
            if (command == '1')
                insert();
            else if (command == '2')
                delete();
            else if (command != '3')
                System.out.println("Wrong command entered, please retry.");
        }
    }
}

```

**FIGURE 10.22** (continued)

```
        }
        combineFiles();
        sortFile();
        outfile.close();
        sorted.close();
        overflow.close();
        fin.close();
        (new File(".\\", "names")).delete();
        (new File(".\\", "sorted")).renameTo(new File(".\\", "names"));
    } catch (IOException ioe) {
    }
}

static public void main(String args[]) {
    String fileName = "";
    InputStreamReader isr = new InputStreamReader(System.in);
    BufferedReader buffer = new BufferedReader(isr);
    FileHashing fClass = new FileHashing();
    try {
        if (args.length == 0) {
            System.out.print("Enter a file name: ");
            fileName = buffer.readLine();
        }
        else fileName = args[0];
    } catch (IOException io) {
        System.err.println("Cannot open " + fileName);
    }
    fClass.processFile(fileName);
}
}
```

## 10.8

## EXERCISES

1. What is the minimum number of keys that are hashed to their home positions using the linear probing technique? Show an example using a 5-cell array.
2. Consider the following hashing algorithm (Bell and Kaman, 1970). Let  $Q$  and  $R$  be the quotient and remainder obtained by dividing  $K$  by  $TSize$ , and let the probing sequence be created by the following recurrence formula:

$$h_i(K) = \begin{cases} R & \text{if } i = 0 \\ (h_{i-1}(K) + Q) \bmod TSize & \text{otherwise} \end{cases}$$

What is the desirable value of  $TSize$ ? What condition should be imposed on  $Q$ ?

3. Is there any advantage to using binary search trees instead of linked lists in the separate chaining method?
4. In Cichelli's method for constructing the minimal hash function, why are all words first ordered according to the occurrence of the first and the last letters? The subsequent searching algorithm does not make any reference to this order.
5. Trace the execution of the searching algorithm used in Cichelli's technique with  $Max = 3$ . (See the illustration of such a trace for  $Max = 4$  in Figure 10.11.)
6. In which case does Cichelli's method not guarantee to generate a minimal perfect hash function?
7. Apply the FHCD algorithm to the nine Muses with  $r = n/2 = 4$  and then with  $r = 2$ . What is the impact of the value of  $r$  on the execution of this algorithm?
8. Strictly speaking, the hash function used in extendible hashing also dynamically changes. In what sense is this true?
9. Consider an implementation of extendible hashing that allows buckets to be pointed to by only one reference. The directory contains null references so that all references in the directory are unique except the null references. What keys are stored in the buckets? What are the advantages and disadvantages of this implementation?
10. How would the directory used in extendible hashing be updated after splitting if the last *depth* bits of  $h(K)$  are considered an index to the directory, not the first *depth* bits?
11. List the similarities and differences between extendible hashing and  $B^+$ -trees.
12. What is the impact of the uniform distribution of keys over the buckets in extendible hashing on the frequency of splitting?
13. Apply the linear hashing method to hash numbers 12, 24, 36, 48, 60, 72, and 84 to an initially empty table with three buckets and with three cells in the overflow area. What problem can you observe? Can this problem bring the algorithm to a halt?



14. Outline an algorithm to delete a key from a table when the linear hashing method is used for inserting keys.
15. The method `hash()` applied in the case study uses the exclusive or (xor) operation to fold all the characters in a string. Would it be a good idea to replace it by bitwise-and or bitwise-or?

**10.9****PROGRAMMING ASSIGNMENTS**

1. As discussed in this chapter, the linear probing technique used for collision resolution has a rapidly deteriorating performance if a relatively small percentage of the cells are available. This problem can be solved using another technique for resolving collisions, and also by finding a better hash function, ideally, a perfect hash function. Write a program that evaluates the efficiency of various hashing functions combined with the linear probing method. Have your program write a table similar to the one in Figure 10.4, which gives the averages for successful and unsuccessful trials of locating items in the table. Use string methods and a large text file whose words will be hashed to the table. Here are some examples of hash functions (all values are divided modulo  $TSize$ ):
  - a. `FirstLetter(s) + SecondLetter(s) + ... + LastLetter(s)`
  - b. `FirstLetter(s) + LastLetter(s) + length(s)` (Cichelli)
  - c. 

```
for (i = 0, index = 0; i < s.length; i++)
    index = (26 * index + s.charAt(i) - ' ');
```

 (Ramakrishna)
2. Another way of improving the performance of hashing is to allow reorganization of the hash table during insertions. Write a program that compares the performance of linear probing with the following self-organization hashing methods:
  - a. *Last-come-first-served hashing* places a new element in its home position, and in case of a collision, the element that occupies this position is inserted in another position using a regular linear probing method to make room for the arriving element (Poblete and Munro, 1989).
  - b. *Robin Hood hashing* checks the number of positions two colliding keys are away from their home positions and continues searching for an open position for the key closer to its home position (Celis et al., 1985).
3. Write a program that inserts records into a file and retrieves and deletes them using either extendible hashing or the linear hashing technique.
4. Extend the program presented in the case study by creating a linked list of overflowing records associated with each bucket of the intermediate file `outfile`. Note that if a bucket has no empty cells, the search continues in the overflow area. In the extreme case, it may mean that the bucket holds only deleted items, and new items are inserted in the overflow area. Therefore, it may be advantageous to have a purging method that, after a certain number of deletions, is automatically invoked. This method transfers items from the overflow area to the main file, which are hashed to buckets with deleted items. Write such a method.


**BIBLIOGRAPHY**

- Bell, James R., and Kaman, Charles H., "The Linear Quotient Hash Code," *Communications of the ACM* 13 (1970), 675–677.
- Celis, P., Larson P., and Munro J. I., "Robin Hood Hashing," *Proceedings of the 26th IEEE Symposium on the Foundations of Computer Science* (1985), 281–288.
- Cichelli, Richard J., "Minimal Perfect Hash Function Made Simple," *Communications of the ACM* 23 (1980), 17–19.
- Czech, Zbigniew J., and Majewski, Bohdan S., "A Linear Time Algorithm for Finding Minimal Perfect Hash Functions," *Computer Journal* 36 (1993), 579–587.
- Enbody, R. J., and Dy, H. C., "Dynamic Hashing Schemes," *Computing Surveys* 20 (1988), 85–113.
- Fagin, Ronald, Nievergelt, Jurg, Pippenger, Nicholas, and Strong, H. Raymond, "Extendible Hashing—A Fast Access Method for Dynamic Files," *ACM Transactions on Database Systems* 4 (1979), 315–344.
- Fox, Edward A., Heath, Lenwood S., Chen, Qi F., and Daoud, Amjad M., "Practical Minimal Perfect Hash Functions for Large Databases," *Communications of the ACM* 35 (1992), 105–121.
- Haggard, G., and Karplus, K., "Finding Minimal Perfect Hash Functions," *SIGCSE Bulletin* 18 (1986), No. 1, 191–193.
- Knott, G. D., "Expandable Open Addressing Hash Table Storage and Retrieval," *Proceedings of the ACM SIGFIDET Workshop on Data Description, Access, and Control* (1971), 186–206.
- Knuth, Donald, *The Art of Computer Programming*, Vol. 3, Reading, MA: Addison-Wesley, 1998.
- Larson, Per A., "Dynamic Hashing," *BIT* 18 (1978), 184–201.
- Larson, Per A., "Dynamic Hash Tables," *Communications of the ACM* 31 (1988), 446–457.
- Lewis, Ted G., and Cook, Curtis R., "Hashing for Dynamic and Static Internal Tables," *IEEE Computer* (October 1986), 45–56.
- Litwin, Witold, "Linear Hashing: A New Tool for File and Table Addressing," *Proceedings of the Sixth Conference of Very Large Databases* (1980), 212–223.
- Litwin, Witold, "Virtual Hashing: A Dynamically Changing Hashing," *Proceedings of the Fourth Conference of Very Large Databases* (1978), 517–523.
- Lomet, David B., "Bounded Index Exponential Hashing," *ACM Transactions on Database Systems* 8 (1983), 136–165.
- Lum, V. Y., Yuen, P. S. T., and Dood, M., "Key-to-Address Transformation Techniques: A Fundamental Performance Study on Large Existing Formatted Files," *Communications of the ACM* 14 (1971), 228–239.
- Morris, Robert, "Scatter Storage Techniques," *Communications of the ACM* 11 (1968), 38–44.
- Mullin, James K., "Tightly Controlled Linear Hashing Without Separate Overflow Storage," *BIT* 21 (1981), 390–400.
- Pagli, L., "Self-Adjusting Hash Tables," *Information Processing Letters* 21 (1985), 23–25.

- Poblete, Patricio V., and Munro, J. Ian, "Last-Come-First-Served Hashing," *Journal of Algorithms* 10 (1989), 228–248.
- Radke, Charles E., "The Use of the Quadratic Search Residue," *Communications of the ACM* 13 (1970), 103–105.
- Sager, Thomas J., "A Polynomial Time Generator for Minimal Perfect Hash Functions," *Communications of the ACM* 28 (1985), 523–532.
- Sebesta, Robert W., and Taylor, Mark A., "Fast Identification of Ada and Modula-2 Reserved Words," *Journal of Pascal, Ada, and Modula-2* (March/April 1986), 36–39.
- Tharp, Alan L., *File Organization and Processing*, New York: Wiley, 1988.
- Vitter, Jeffrey S., and Chen, Wen C., *Design and Analysis of Coalesced Hashing*, New York: Oxford University Press, 1987.

# 11

# Data Compression

**T**ransfer of information is essential for the proper functioning of any structure on any level and any type of organization. The faster an exchange of information occurs, the smoother the structure functions. Improvement of the rate of transfer can be achieved by improving the medium through which data are transferred or by changing the data themselves so that the same information can be transmitted within a shorter time interval.

Information can be represented in a form that exhibits some redundancy. For example, in a database, it is enough to say about a person that he is “M” or she is “F,” instead of spelling out the whole words, “male” and “female,” or to use 1 and 2 to represent the same information. The number one hundred twenty-eight can be stored as 80 (hexadecimal), 128, 1000000 (binary), CXXVIII, ρκη (the Greek language used letters as digits), or |||. . . | (128 bars). If numbers are stored as the sequences of digits representing them, then 80 is the shortest form. Numbers are represented in binary form in computers.

## 11.1

### CONDITIONS FOR DATA COMPRESSION

When transferring information, the choice of the data representation determines how fast the transfer is performed. A judicious choice can improve the throughput of a transmission channel without changing the channel itself. There are many different methods of *data compression* (or *compaction*) that reduce the size of the representation without affecting the information itself.

Assume that there are  $n$  different symbols used to code messages. For a binary code,  $n = 2$ ; for Morse code,  $n = 3$ : the dot, the dash, and the blank separating the sequences of dots and dashes that represent letters. Assume also that all symbols  $m_i$  forming a set  $M$  have been independently chosen and are known to have probabilities of occurrence  $P(m_i)$ , and the symbols are coded with strings of 0s and 1s. Then  $P(m_1) + \cdots + P(m_n) = 1$ . The information content of the set  $M$ , called the *entropy* of the source  $M$ , is defined by

$$L_{\text{ave}} = P(m_1)L(m_1) + \cdots + P(m_n)L(m_n) \quad (11.1)$$

where  $L(m_i) = -\lg(P(m_i))$ , which is the minimum length of a codeword for symbol  $m_i$ . Claude E. Shannon established in 1948 that Equation 11.1 gives the best possible average length of a codeword when the source symbols and the probabilities of their use are known. No data compression algorithm can be better than  $L_{\text{ave}}$ , and the closer it is to this number, the better is its compression rate.

For example, if there are three symbols,  $m_1$ ,  $m_2$ , and  $m_3$ , with the probabilities .25, .25, and .5, respectively, then the lengths of the codewords assigned to them are:

$$-\lg(P(m_1)) = -\lg(P(m_2)) = -\lg(.25) = \lg\left(\frac{1}{.25}\right) = \lg(4) = 2 \text{ and}$$

$$-\lg(P(m_3)) = \lg(2) = 1$$

and the average length of a codeword is

$$L_{\text{ave}} = P(m_1) \cdot 2 + P(m_2) \cdot 2 + P(m_3) \cdot 1 = 1.5$$

Various data compression techniques attempt to minimize the average codeword length by devising an optimal code (that is, an assignment of codewords to symbols) that depends on the probability  $P$  with which a symbol is being used. If a symbol is issued infrequently, it can be assigned a long codeword. For frequently issued symbols, very short encodings are more to the point.

Some restrictions need to be imposed on the prospective codes:

1. Each codeword corresponds to exactly one symbol.
2. Decoding should not require any look ahead; after reading each symbol it should be possible to determine whether the end of a string encoding a symbol of the original message has been reached. A code meeting this requirement is called a code with the *prefix property*, and it means that no codeword is a prefix of another codeword. Therefore, no special punctuation is required to separate two codewords in a coded message.

The second requirement can be illustrated by three different encodings of three symbols, as given in the following table:

Symbol	<i>code</i> <sub>1</sub>	<i>code</i> <sub>2</sub>	<i>code</i> <sub>3</sub>
A	1	1	11
B	2	22	12
C	12	12	21

The first code does not allow us to make a distinction between AB and C, because both are coded as 12. The second code does not have this ambiguity, but it requires a look ahead, as in 1222: The first 1 can be decoded as A. The following 2 may indicate that A was improperly chosen, and 12 should have been decoded as C. It may be that A is a proper choice if the third symbol is 2. Because 2 is found, AB is chosen as the tentatively decoded string, but the fourth symbol is another 2. Hence, the first turn was wrong, and A has been ill-chosen. The proper decoding is CB. All these problems arise because both *code*<sub>1</sub> and *code*<sub>2</sub> violate the prefix property. Only *code*<sub>3</sub> can be unambiguously decoded as read.

For an optimal code, two more stipulations are specified.

3. The length of the codeword for a given symbol  $m_j$  should not exceed the length of the codeword of a less probable symbol  $m_i$ ; that is, if  $P(m_i) \leq P(m_j)$ , then  $L(m_i) \geq L(m_j)$  for  $1 \leq i, j \leq n$ .
4. In an optimal encoding system, there should not be any unused short codewords either as stand-alone encodings or as prefixes for longer codewords, because this would mean that longer codewords were created unnecessarily. For example, the sequence of codewords 01, 000, 001, 100, 101 for a certain set of five symbols is not optimal because the codeword 11 is not used anywhere; this encoding can be turned into an optimal sequence 01, 10, 11, 000, 001.

In the following sections, several data compression methods are presented. To compare the efficiency of these methods when applied to the same data, the same measure is used. This measure is the *compression rate* (also called the *fraction of data reduction*), and it is defined as the ratio

$$\frac{\text{length(input)} - \text{length(output)}}{\text{length(input)}} \quad (11.2)$$

It is expressed as a percentage indicating the amount of redundancy removed from the input.

## 11.2 HUFFMAN CODING

The construction of an optimal code was developed by David Huffman, who utilized a tree structure in this construction: a binary tree for a binary code. The algorithm is surprisingly simple and can be summarized as follows:

```
Huffman ( )
  for each symbol create a tree with a single root node and order all trees
    according to the probability of symbol occurrence;
  while more than one tree is left
    take the two trees  $t_1, t_2$  with the lowest probabilities  $p_1, p_2$  ( $p_1 \leq p_2$ )
    and create a tree with  $t_1$  and  $t_2$  as its children and with
    the probability in the new root equal to  $p_1 + p_2$ ;
    associate 0 with each left branch and 1 with each right branch;
    create a unique codeword for each symbol by traversing the tree from the root
    to the leaf containing the probability corresponding to this
    symbol and by putting all encountered 0s and 1s together;
```

The resulting tree has a probability of 1 in its root.

It should be noted that the algorithm is not deterministic in the sense of producing a unique tree because, for trees with equal probabilities in the roots, the algorithm does not prescribe their positions with respect to each other either at the beginning or during execution. If  $t_1$  with probability  $p_1$  is in the sequence of trees and the new tree  $t_2$  is created with  $p_2 = p_1$ , should  $t_2$  be positioned to the left of  $t_1$  or to the right? Also, if there are three trees,  $t_1$ ,  $t_2$ , and  $t_3$ , with the same lowest probability in the entire sequence, which two trees should be chosen to create a new tree? There are three possi-

bilities for choosing two trees. As a result, different trees can be obtained depending on where the trees with equal probabilities are placed in the sequence with respect to each other. Regardless of the shape of the tree, the average length of the codeword remains the same.

To assess the compression efficiency of the Huffman algorithm, a definition of the *weighted path length* is used, which is the same as Equation 11.1 except that  $L(m_i)$  is interpreted as the number of 0s and 1s in the codeword assigned to symbol  $m_i$  by this algorithm.

Figure 11.1 contains an example for the five letters A, B, C, D, and E with probabilities .39, .21, .19, .12, and .09, respectively. The tree in Figures 11.1a and 11.1b are different in the way in which the two nodes containing a probability of .21 have been chosen to be combined with tree .19 to create a tree of .40. Regardless of the choice, the lengths of the codewords associated with the five letters A through E are the same, namely, 2, 2, 2, 3, and 3, respectively. However, the codewords assigned to them are slightly different, as shown in Figures 11.1c and 11.1d, which present abbreviated (and more commonly used) versions of the way the trees in Figures 11.1a and 11.1b were created. The average length for the latter two trees is

$$L_{\text{Huf}} = .39 \cdot 2 + .21 \cdot 2 + .19 \cdot 2 + .12 \cdot 3 + .09 \cdot 3 = 2.21$$

which is very close to 2.09 (only 5 percent off), the average length computed according to Equation 11.1:

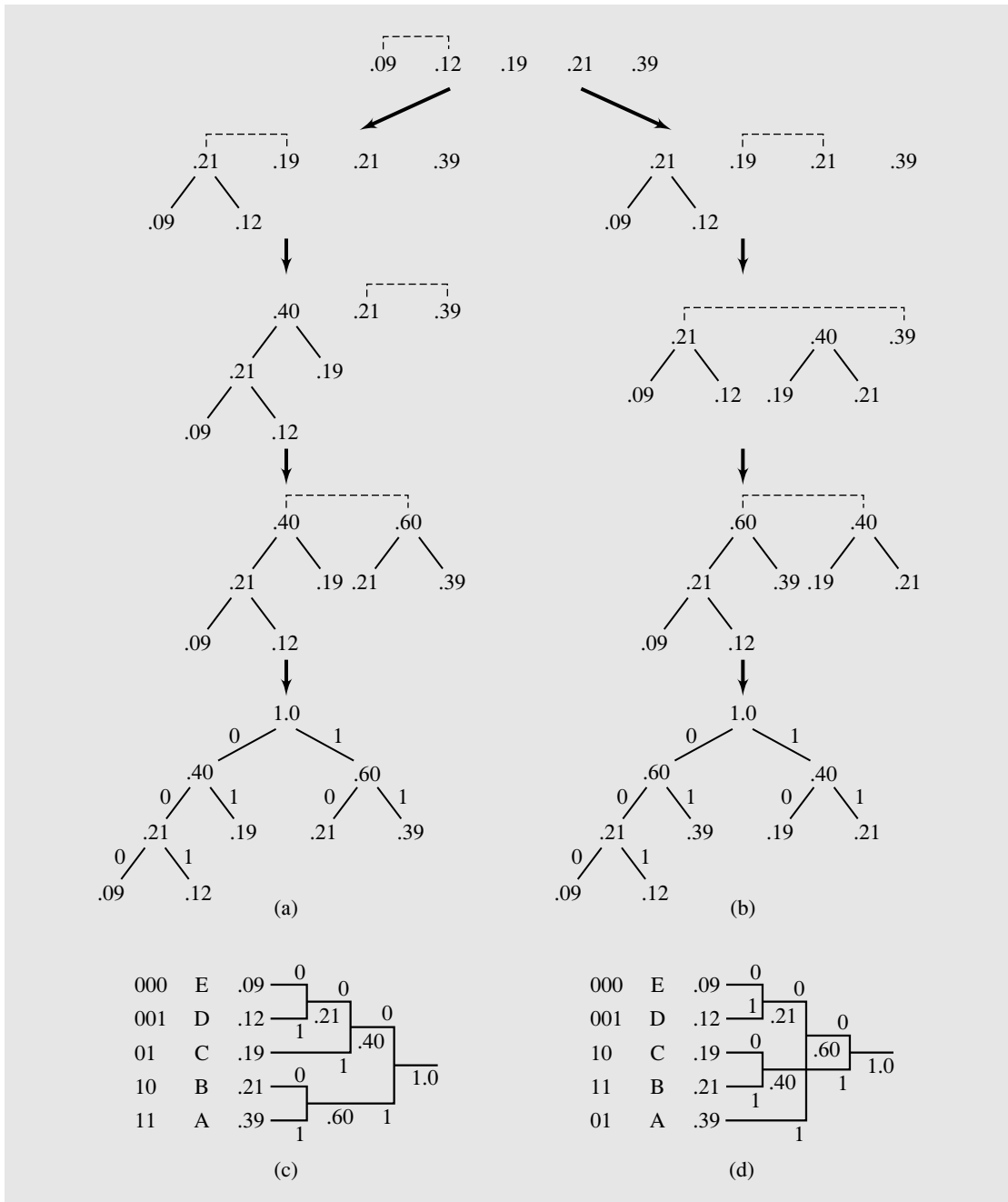
$$L_{\text{ave}} = .39 \cdot 1.238 + .21 \cdot 2.252 + .19 \cdot 2.396 + .12 \cdot 3.059 + .09 \cdot 3.474 = 2.09$$

Corresponding letters in Figures 11.1a and 11.1b have been assigned codewords of the same length. Obviously, the average length for both trees is the same. But each way of building a Huffman tree, starting from the same data, should result in the same average length, regardless of the shape of the tree. Figure 11.2 shows two Huffman trees for the letters P, Q, R, S, and T with the probabilities .1, .1, .1, .2, and .5, respectively. Depending on how the lowest probabilities are chosen, different codewords are assigned to these letters with different lengths, at least for some of them. However, the average length remains the same and is equal to 2.0.

The Huffman algorithm can be implemented in a variety of ways, at least as many as the number of ways a priority queue can be implemented. The priority queue is the natural data structure in the context of the Huffman algorithm because it requires removing the two smallest probabilities and inserting the new probability in the proper position.

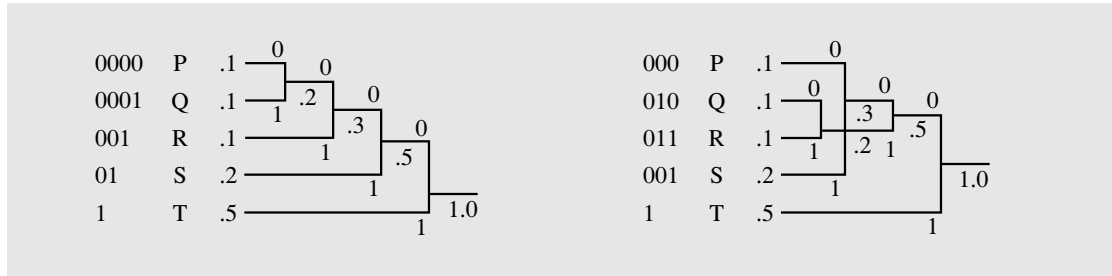
One way to implement this algorithm is to use a singly linked list of references to trees, which reflects closely what Figure 11.1a illustrates. The linked list is initially ordered according to the probabilities stored in the trees, all of them consisting of just a root. Then, repeatedly, the two trees with the smallest probabilities are chosen; the tree with the smaller probability is replaced by a newly created tree, and the node with the reference to the tree with the higher probability is removed from the linked list. From trees having the same probability in their roots, the first tree encountered is chosen.

**FIGURE 11.1** Two Huffman trees created for five letters A, B, C, D, and E with probabilities .39, .21, .19, .12, and .09.





**FIGURE 11.2** Two Huffman trees generated for letters P, Q, R, S, and T with probabilities .1, .1, .1, .2, and .5.



In another implementation, all probability nodes are first ordered, and that order is maintained throughout the operation. From such an ordered list, the first two trees are always removed to create a new tree from them, which is inserted close to the end of the list. To that end, a doubly linked list of references to trees with immediate access to the beginning and to the end of this list can be used. Figure 11.3 contains a trace of the execution of this algorithm for the letters A, B, C, D, and E with the same probabilities as in Figure 11.1. Codewords assigned to these letters are also indicated in Figure 11.3. Note that they are different from the codewords in Figure 11.1, although their lengths are the same.

The two preceding algorithms built Huffman trees bottom-up by starting with a sequence of trees and collapsing them together to a gradually smaller number of trees and, eventually, to one tree. However, this tree can be built top-down, starting from the highest probability. But only the probabilities to be placed in the leaves are known. The highest probability, to be put in the root, is known if lower probabilities, in the root's children, have been determined; the latter are known if still lower probabilities have been computed, and so on. Therefore, creating nonterminal nodes has to be deferred until the probabilities to be stored in them are found. It is very convenient to use the following recursive algorithm to implement a Huffman tree:

```

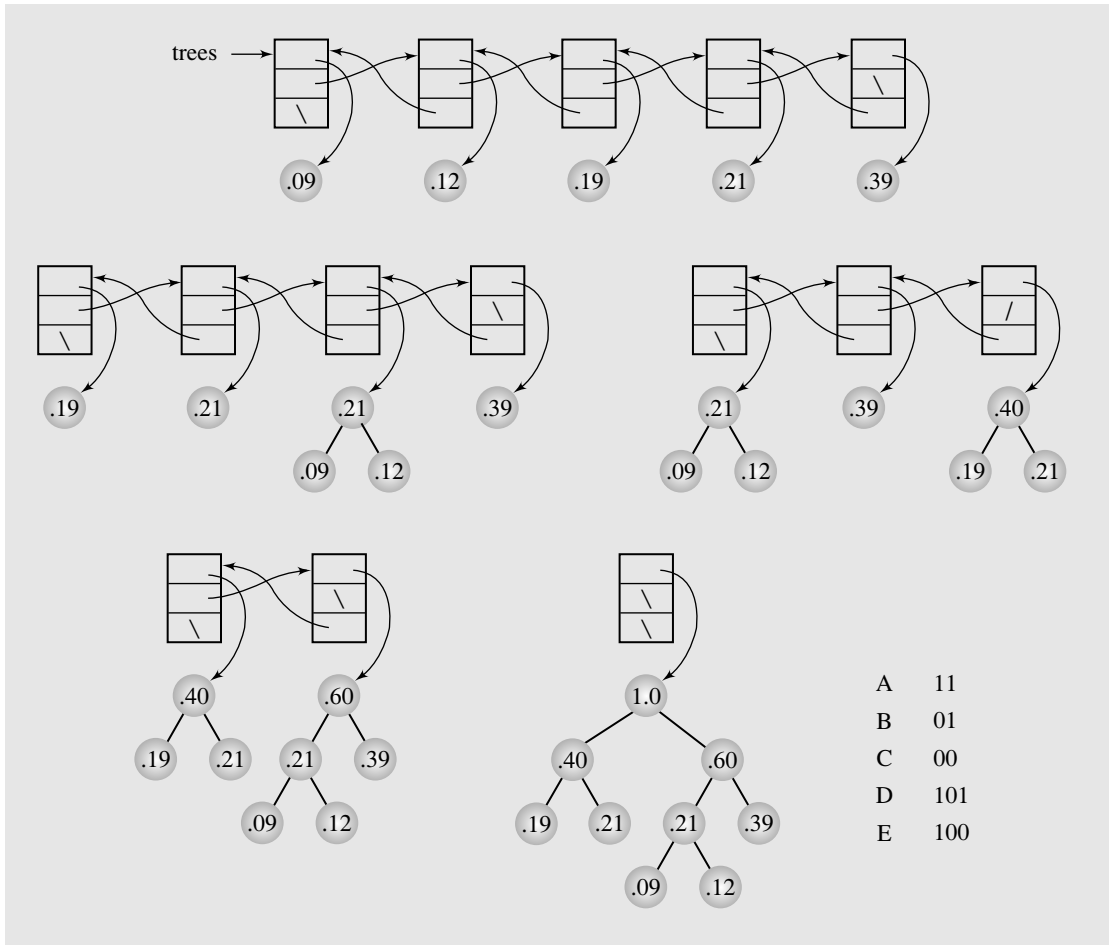
createHuffmanTree(prob)
  declare the probabilities  $p_1$ ,  $p_2$ , and the Huffman tree Htree;
  if only two probabilities are left in prob
    return a tree with  $p_1$ ,  $p_2$  in the leaves and  $p_1 + p_2$  in the root;
  else remove the two smallest probabilities from prob and assign them to  $p_1$  and  $p_2$ ;
    insert  $p_1 + p_2$  to prob;
    Htree = createHuffmanTree(prob);
    in Htree make the leaf with  $p_1 + p_2$  the parent of two leaves with  $p_1$  and  $p_2$ ;
  return Htree;

```

Figure 11.4 contains a summary of the trace of the execution of this algorithm for the letters A, B, C, D, and E with the probabilities as shown in Figure 11.1. Indentation indicates consecutive calls to `createHuffmanTree()`.

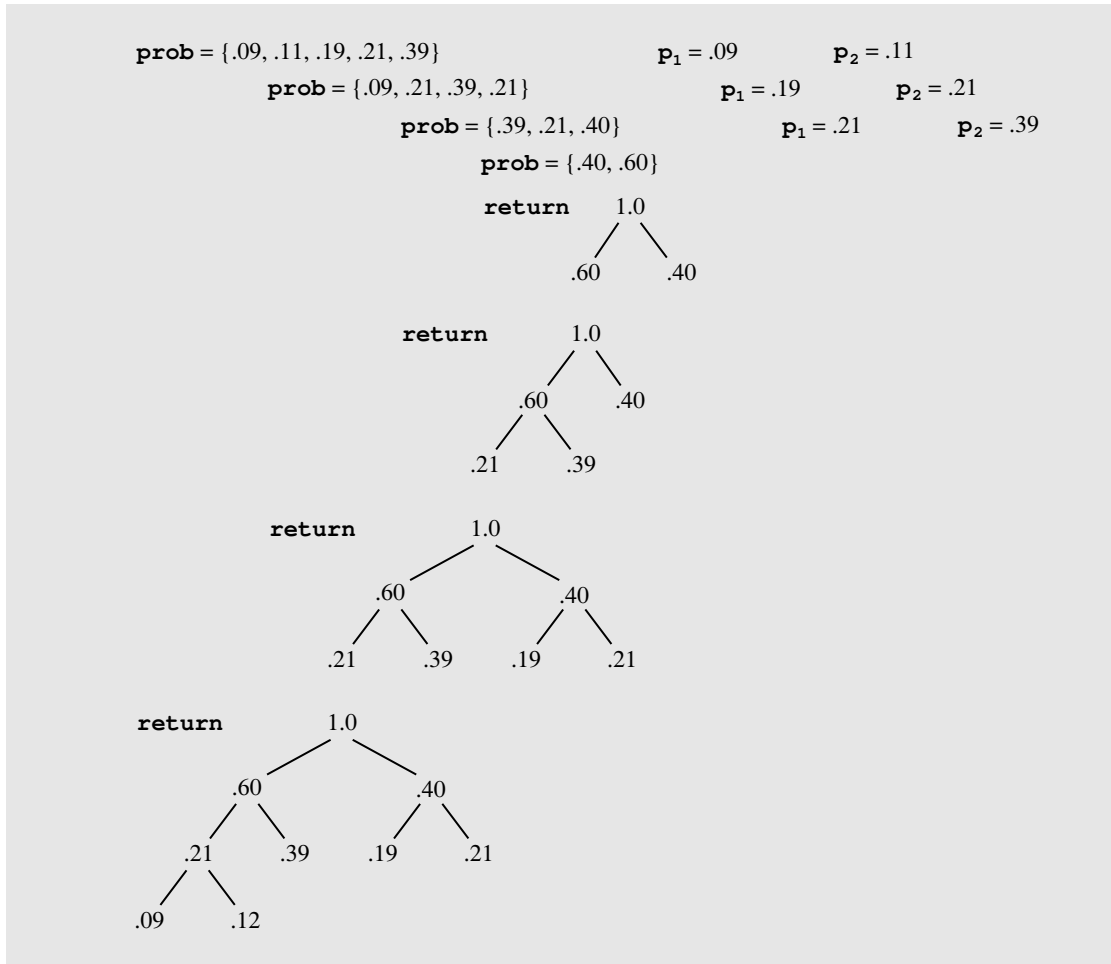
One implementation of a priority queue is a min heap, which can also be used to implement this algorithm. In this heap, each nonterminal node has a smaller probability

**FIGURE 11.3** Using a doubly linked list to create the Huffman tree for the letters from Figure 11.1.



than the probabilities in its children, and because the smallest probability is in the root, that one is simple to remove. But after it is removed, the root is empty. Therefore, the largest element is put in the root and the heap property is restored. Then the second element can be removed from the root and replaced with a new element, which represents the sum of the probability of the root and the probability previously removed.

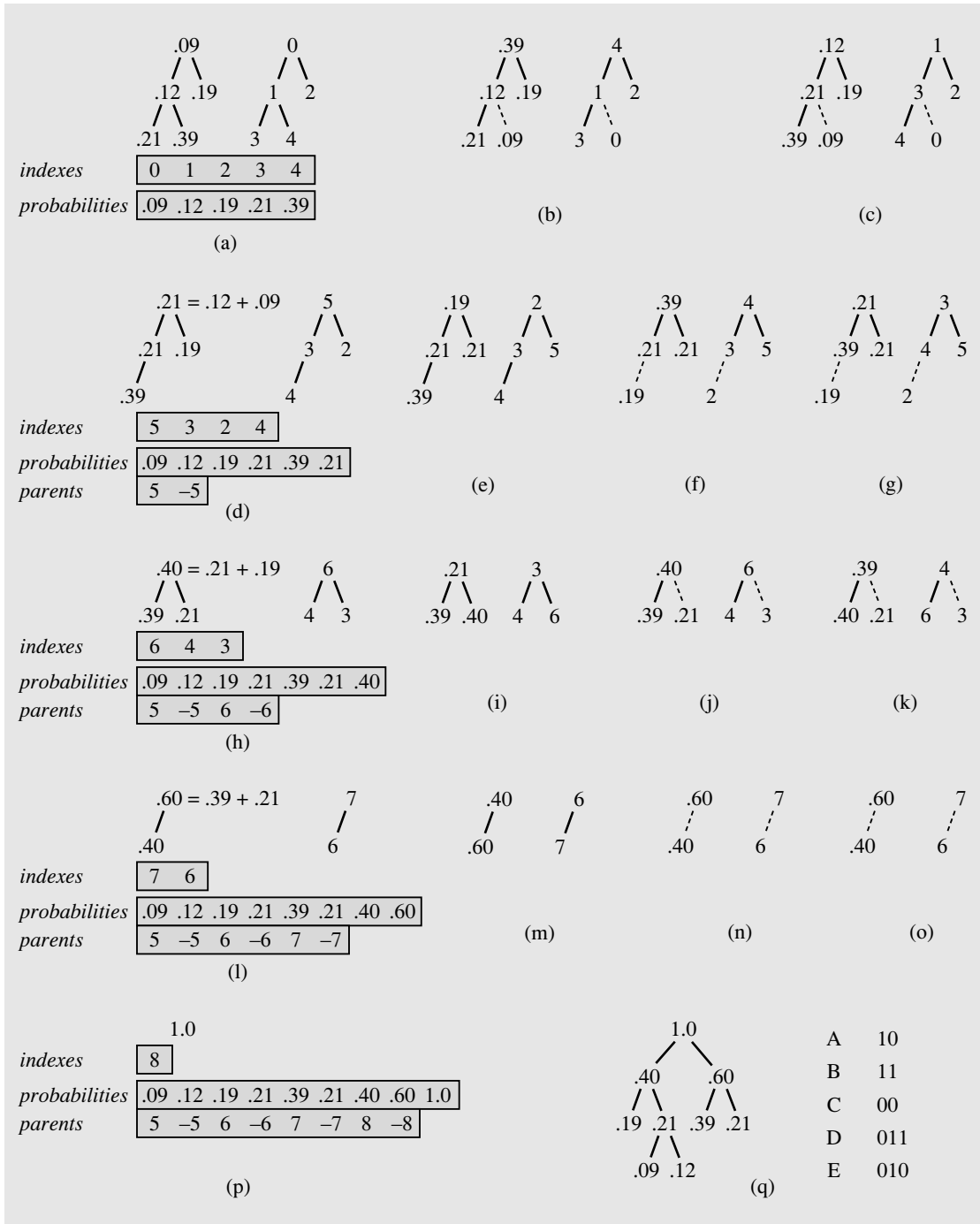
Afterward, the heap property has to be restored again. After one such sequence of operations, the heap has one less node: Two probabilities from the previous heap have been removed and a new one has been added. But it is not enough to create the Huffman tree: The new probability is a parent of the probabilities just removed, and this information must be retained. To that end, three arrays can be used: *indexes* containing the indexes of the original probabilities and the probabilities created during the process of creating the Huffman tree; *probabilities*, an array of the original and newly created probabilities; and *parents*, an array of indexes indicating the position of the

**FIGURE 11.4** Top-down construction of a Huffman tree using recursive implementation.

parents of the elements stored in *probabilities*. A positive number in *parents* indicates the left child, and a negative number indicates the right child. Codewords are created by accumulating 0s and 1s when going from leaves to the root using the array *parents*, which functions as an array of references. It is important to note that in this particular implementation probabilities are sorted indirectly: The heap is actually made up of indexes to probabilities, and all exchanges take place in *indexes*.

Figure 11.5 illustrates an example of using a heap to implement the Huffman algorithm. The heaps in steps (a), (e), (i), and (m) in Figure 11.5 are ready for processing. First, the highest probability is put in the root, as in steps (b), (f), (j), and (n) of Figure 11.5. Next, the heap is restored, as in steps (c), (g), (k), and (o), and the root probability is set to the sum of the two smallest probabilities, as in steps (d), (h), (l), and (p). Processing is complete when there is only one node in the heap.

**FIGURE 11.5** Huffman algorithm implemented with a heap.



Using the Huffman tree, a table can be constructed that gives the equivalents for each symbol in terms of 1s and 0s encountered along the path leading to each of the leaves of the tree. For our example, the tree from Figure 11.3 will be used, and the resulting table is

A	11
B	01
C	00
D	101
E	100

The coding process transmits coded equivalents of the symbols to be sent. For example, instead of sending ABAAD, the sequence 1101111101 is dispatched with the average number of bits per one letter equal to  $11/5 = 2.2$ , almost the same as 2.09, the value specified by the formula for  $L_{ave}$ . To decode this message, the conversion table has to be known to the message receiver. Using this table, a Huffman tree can be constructed with the same paths as the tree used for coding, but its leaves would (for the sake of efficiency) store the symbols instead of their probabilities. In this way, upon reaching a leaf, the symbol can be retrieved directly from it. Using this tree, each symbol can be decoded uniquely. For example, if 1001101 is received, then we try to reach a leaf of the tree using the path indicated by leading 1s and 0s. In this case, 1 takes us to the right, 0 to the left, and another 0 again to the left, whereby we end up in a leaf containing E. After reaching this leaf, decoding continues by starting from the root of the tree and trying to reach a leaf using the remaining 0s and 1s. Because 100 has been processed, 1101 has to be decoded. Now, 1 takes us to the right and another 1 again to the right, which is a leaf with A. We start again from the root, and the sequence 01 is decoded as B. The entire message is now decoded as EAB.

At this point, a question can be asked: Why send 1101111101 instead of ABAAD? This is supposed to be data compression, but the coded message is twice as long as the original. Where is the advantage? Note precisely the way in which messages are sent. A, B, C, D, and E are single letters, and letters, being characters, require 1 byte (8 bits) to be sent, using the extended ASCII code. Therefore, the message ABAAD requires 5 bytes (40 bits). On the other hand, 0s and 1s in the coded version can be sent as single bits. Therefore, if 1101111101 is regarded not as a sequence of the characters “0” and “1,” but as a sequence of bits, then only 11 bits are needed to send the message, about one-fourth of what is required to send the message in its original form, ABAAD.

This example raises one problem: Both the encoder and the decoder have to use the same coding, the same Huffman tree. Otherwise, the decoding will be unsuccessful. How can the encoder let the decoder know which particular code has been used? There are at least three possibilities:

1. Both the encoder and the decoder agree beforehand on a particular Huffman tree and both use it for sending any message.
2. The encoder constructs the Huffman tree afresh every time a new message is sent and sends the conversion table along with the message. The decoder either uses the table to decode the message or reconstructs the corresponding Huffman tree and then performs the translation.
3. The decoder constructs the Huffman tree during transmission and decoding.

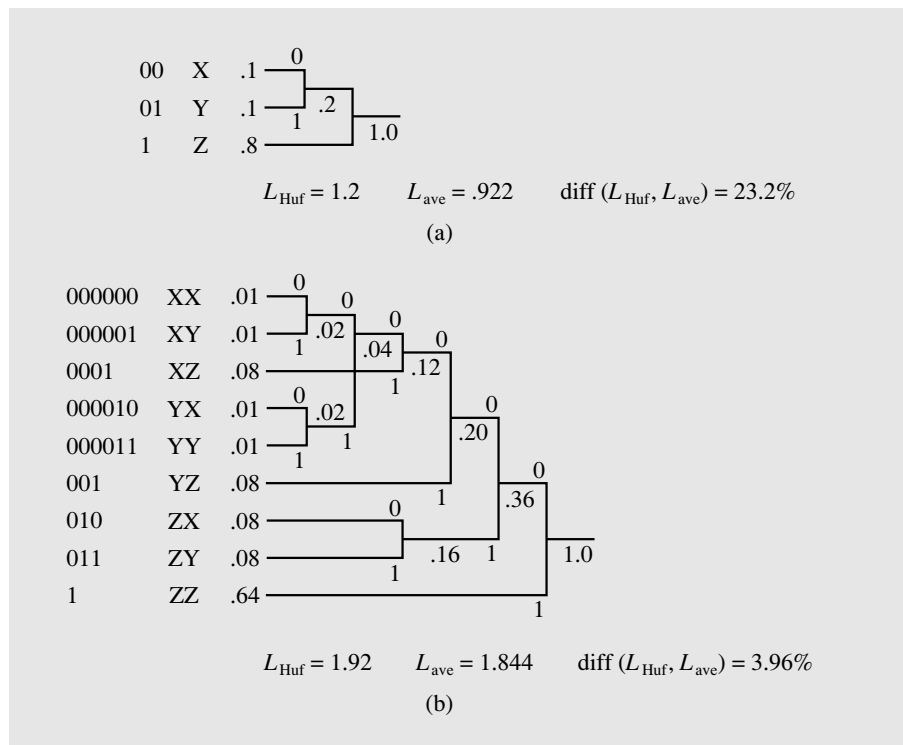
The second strategy is more versatile, but its advantages are visible only when large files are encoded and decoded. For our simple example, ABAAD, sending both the table of codewords and the coded message 1101111101 is hardly perceived as data compression. However, if a file contains a message of 10,000 characters using the characters A through E, then the space saved is significant. Using the probabilities indicated earlier for these letters, we project that there are approximately 3,900 As, 2,100 Bs, 1,900 Cs, 1,200 Ds, and 900 Es. Hence, the number of bits needed to code this file is

$$3,900 \cdot 2 + 2,100 \cdot 2 + 1,900 \cdot 2 + 1,200 \cdot 3 + 900 \cdot 3 = 22,100 \text{ bits} = 2,762.5 \text{ bytes}$$

which is approximately one-fourth the 10,000 bytes required for sending the original file. Even if the conversion table is added to the file, this proportion is only minimally affected.

However, even with this approach, there may be some room for improvement. As indicated, an ideal compression algorithm should give the same average codeword length as computed from Equation 11.1. The symbols from Figure 11.1 have been assigned codewords whose average length is 2.21, approximately 5 percent worse than the ideal 2.09. Sometimes, however, the difference is larger. Consider, for example, three symbols, X, Y, and Z, with probabilities .1, .1, and .8. Figure 11.6a shows a Huff-

**FIGURE 11.6** Improving the average length of the codeword by applying the Huffman algorithm to (b) pairs of letters instead of (a) single letters.



man tree for these symbols, with codewords assigned to them. The average length, according to this tree, is

$$L_{\text{Huf}} = 2 \cdot .1 + 2 \cdot .1 + 1 \cdot .8 = 1.2$$

and the best expected average,  $L_{\text{ave}}$ , is .922. Therefore, there is a possibility we can improve the Huffman coding by approximately 23.2 percent, ignoring the fact that, at this point, a full 23.2 percent improvement is not possible because the average is below 1. How is this possible? As already stated, all Huffman trees result in the same average weighted path length. Therefore, no improvement can be expected if only the symbols, X, Y, and Z, are used to construct this tree.

On the other hand, if all possible pairs of symbols are used for building a Huffman tree, the data rate can be reduced. Figure 11.6b illustrates this procedure. Out of three symbols, X, Y, and Z, nine pairs are created whose probabilities are computed by multiplying the probability of both symbols. For example, because the probability for both X and Y is .1, the probability of pair XY is  $.01 = .1 \cdot .1$ . The average  $L_{\text{Huf}}$  is 1.92 and the expected average  $L_{\text{ave}}$  is 1.84 (twice the previous  $L_{\text{ave}}$ ), with the difference between these averages being 4 percent. This represents a 19.2 percent improvement at the cost of including a larger conversion table (nine entries instead of three) as part of the message to be sent. If the message is large and the number of symbols used in the message is relatively small, then the increase in the size of the table is insignificant. However, for a large number of symbols, the size of the table may be much too large to notice any improvement. For 26 English letters, the number of pairs is 676, which is considered relatively small. But if all printable characters have to be distinguished in an English text, from the blank character (ASCII code 32) to the tilde (ASCII code 126), plus the carriage return character, then there are  $(126 - 32 + 1) + 1 = 96$  characters and 9,216 pairs of characters. Many of these pairs are not likely to occur at all (e.g., XQ or KZ), but even if 50 percent of them are found, the resulting table containing these pairs along with codewords associated with them may be too large to be useful.

Using pairs of symbols is still a good idea, even if the number of symbols is large. For example, a Huffman tree can be constructed for all symbols and for all pairs of symbols that occur at least five times. The efficiency of the variations of Huffman encoding can be measured by comparing the size of compressed files. Experiments were performed on an English text, a PL/1 program file, and a digitized photographic image (Rubin 1976). When only single characters were used, the compression rates were approximately 40 percent, 60 percent, and 50 percent, respectively. When single characters were used along with the 100 most frequent groups (not only two characters long), the compression rates were 49 percent, 73 percent, and 52 percent. When the 512 most frequent groups were used, the compression rates were around 55 percent, 71 percent, and 62 percent.

### 11.2.1 Adaptive Huffman Coding

The foregoing discussion assumed that the probabilities of messages are known in advance. A natural question is: How do we know them?

One solution computes the number of occurrences of each symbol expected in messages in some fairly large sample of texts of, say, 10 million characters. For messages in natural languages such as English, such samples may include some literary

works, newspaper articles, and a portion of an encyclopedia. After each character's frequency has been determined, a conversion table can be constructed for use by both the sending and receiving ends of the data transfer. This eliminates the need to include such a table every time a file is transmitted.

However, this method may not be useful for sending some specialized files, even if written in English. A computer science paper includes a much higher percentage of digits and parentheses, especially if it includes extensive illustrations in LISP or Java code, than a paper on the prose of Jane Austen. In such circumstances, it is more judicious to use the text to be sent to determine the needed frequencies, which also requires enclosing the table as overhead in the file being sent. A preliminary pass through this file is required before an actual conversion table can be constructed; however, the file to be preprocessed may be very large, and preprocessing slows down the entire transmission process. Also, the file to be sent may not be known in its entirety when it is being sent, and yet compression is necessary; for example, when a text is being typed and sent line by line, there is no way to know the contents of the whole file at the time of sending. In such a situation, adaptive compression is a viable solution.

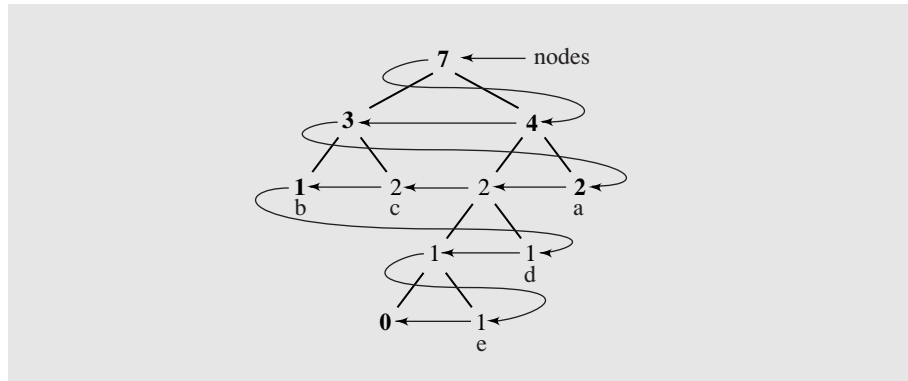
An adaptive Huffman encoding technique was devised first by Robert G. Gallager and then improved by Donald Knuth. The algorithm is based on the following *sibling property*: If each node has a sibling (except for the root) and the breadth-first right-to-left tree traversal generates a list of nodes with nonincreasing frequency counters, it can be proven that a tree with the sibling property is a Huffman tree (Faller, 1974; Gallager, 1978).

In adaptive Huffman coding, the Huffman tree includes a counter for each symbol, and the counter is updated every time a corresponding input symbol is being coded. Checking whether the sibling property is retained assures that the Huffman tree under construction is still a Huffman tree. If the sibling property is violated, the tree has to be restructured to restore this property. Here is how this is accomplished.

First, it is assumed that the algorithm maintains a doubly linked list `nodes` that contains the nodes of the tree ordered by breadth-first right-to-left tree traversal. A `blocki` is a part of the list where each node has frequency  $i$ , and the first node in each block is called a *leader*. For example, Figure 11.7 shows the Huffman tree and also the list `nodes = (7 4 3 2 2 2 1 1 1 1 0)` that has six blocks—`block7`, `block4`, `block3`, `block2`, `block1`, and `block0`—with leaders shown with counters in boldface.

All unused symbols are kept in one node with a frequency of 0, and each symbol encountered in the input has its own node in the tree. Initially, the tree has just one 0-node that includes all symbols. If an input symbol did not yet appear in the input, the 0-node is split in two, with the new 0-node containing all symbols except the newly encountered one and the node referring to this new symbol with counter set to 1; both nodes become children of the one parent whose counter is also set to 1. If an input symbol already has a node  $p$  in the tree, its counter is incremented. However, such an increment may endanger the sibling property, so this property has to be restored by exchanging the node  $p$  with the leader of the block to which  $p$  currently belongs, except when this leader is  $p$ 's parent. This node is found by going in `nodes` from  $p$  toward the beginning of this list. If  $p$  belongs to `blocki` before increment, it is swapped with the leader of this block, whereby it is included in `blocki+1`. Then the counter increment is done for  $p$ 's possibly new parent, which may also lead to a tree transformation to restore the sibling property. This process is continued until the root is reached. In this way, the counters are updated on the *new* path from  $p$  to the root rather than on its old path. For each symbol, the codeword is is-



**FIGURE 11.7** Doubly linked list nodes formed by breadth-first right-to-left tree traversal.

sued, which is obtained by scanning the Huffman tree from the root to the node corresponding to this symbol *before* any transformation in the tree takes place.

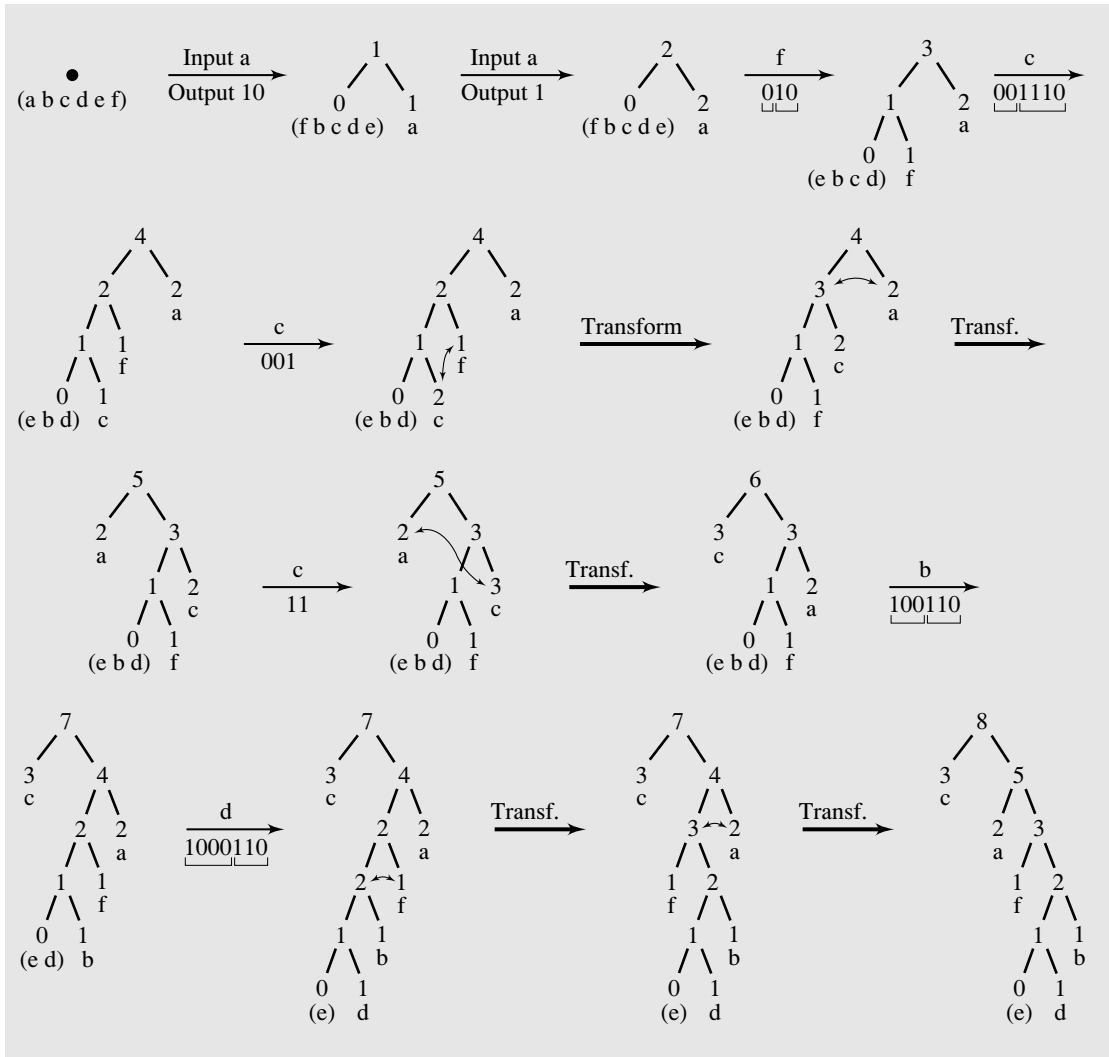
Two different types of codewords are transmitted during this process. If a symbol being coded has already appeared, then the normal coding procedure is applied: The Huffman tree is scanned from the root to the node holding this symbol to determine its codeword. If a symbol appears in the input for the first time, it is in the 0-node, but just sending the Huffman codeword of the 0-node does not suffice. Therefore, along with the codeword allowing us to reach the 0-node, the codeword is sent that indicates the position of the encountered symbol. For the sake of simplicity, we assume that position  $n$  is coded as  $n$  1s followed by a 0. Zero is used to separate the 1s from those belonging to the next codeword. For example, when the letter  $c$  is coded for the first time, its codeword, 001110, is a combination of the codeword for the 0-node, 00, and the codeword 1110 indicating that  $c$  can be found in the third position in the list of unused symbols associated with 0-node. These two codewords (or rather, parts of one codeword) are marked in Figure 11.8 by underlining them separately. After a symbol is removed from the list in 0-node, its place is taken by the last symbol of this list. This also indicates that the encoder and receiver have to agree on the alphabet being used and its ordering. The algorithm is shown in this pseudocode:

```

FGKDynamicHuffmanEncoding(symbol s)
    p = leaf that contains symbol s;
    c = Huffman codeword for s;
    if p is the 0-node
        c = c concatenated with the number of 1s representing position of s in 0-node and with 0;
        write the last symbol in 0-node over s in this node;
        create a new node q for symbol s and set its counter to 1;
        p = new node to become the parent of both 0-node and node q;
        counter(p) = 1;
        include the two new nodes to nodes;
    else increment counter(p);
    while p is not the root

```

**FIGURE 11.8** Transmitting the message “aafccbd” using an adaptive Huffman algorithm.



```

if p violates the sibling property
    if the leader of the blocki that still includes p is not parent(p)
        swap p with the leader;
p = parent(p);
increment counter(p);
return codeword c;
    
```

A step-by-step example for string aafccbd is shown in Figure 11.8.

1. Initially, the tree includes only the 0-node with all the source letters ( $a, b, c, d, e, f$ ). After the first input letter,  $a$ , only the codeword for the position occupied by  $a$  in the 0-node is output. Because it is the first position, one 1 is output, followed by a 0. The last letter in the 0-node is placed in the first position, and a separate node is created for the letter  $a$ . The node, with the frequency count set to 1, becomes a child of another new node that is also the parent of the 0-node.
2. After the second input letter, also an  $a$ , 1 is output, which is the Huffman codeword for the leaf that includes  $a$ . The frequency count of  $a$  is incremented to 2, which violates the sibling property, but because the leader of the block is the parent of node  $p$  (that is, of node  $a$ ), no swap takes place; only  $p$  is updated to point to its parent, and then  $p$ 's frequency count is incremented.
3. The third input letter,  $f$ , is a letter output for the first time; thus, the Huffman codeword for the 0-node, 0, is generated first, followed by the number of 1s corresponding to the position occupied by  $f$  in the 0-node, followed by 0: 10. The letter  $e$  is put in place of letter  $f$  in the 0-node, a new leaf for  $f$  is created, and a new node becomes the parent of the 0-node and the leaf just created. Node  $p$ , which is the parent of leaf  $f$ , does not violate the sibling property, so  $p$  is updated,  $p = \text{parent}(p)$ , thereby becoming the root that is incremented.
4. The fourth input letter is  $c$ , which appears for the first time in the input. The Huffman codeword for the 0-node is generated, followed by three 1s and a 0 because  $c$  is the third letter in the 0-node. After that,  $d$  is put in place of  $c$  in the 0-node, and  $c$  is put in a newly created leaf;  $p$  is updated twice, allowing for incrementing counters of two nodes, left child of the root and the root itself.
5. The letter  $c$  is the next input letter; thus, first the Huffman codeword for its leaf is given, 001. Next, because the sibling property is violated, the node  $p$  (that is, the leaf  $c$ ), is swapped with the leader  $f$  of  $\text{block}_1$  that still includes this leaf. Then,  $p = \text{parent}(p)$ , and the new parent  $p$  of the  $c$  node is incremented, which leads to another violation of the sibling property and to an exchange of node  $p$  with the leader of  $\text{block}_2$ , namely, with the node  $a$ . Next,  $p = \text{parent}(p)$ , node  $p$  is incremented, but because it is the root, the process of updating the tree is finished.
6. The sixth input letter is  $c$ , which has a leaf in the tree, so first, the Huffman codeword, 11, of the leaf is generated and the counter of node  $c$  is incremented. The node  $p$ , which is the node  $c$ , violates the sibling property, so  $p$  is swapped with the leader, node  $a$ , of  $\text{block}_3$ . Now,  $p = \text{parent}(p)$ ,  $p$ 's counter is incremented, and because  $p$  is the root, the tree transformation is concluded for this input letter. The remaining steps can be traced in Figure 11.8.

It is left to the reader to make appropriate modifications to this pseudocode to obtain an `FGKDynamicHuffmanDecoding(codeword c)` algorithm.

It is possible to design a Huffman coding that does not require any initial knowledge of the set of symbols used by the encoder (Cormack and Horspool 1984). The Huffman tree is initialized to a special escape character. If a new symbol is to be sent, it is preceded by the escape character (or its current codeword in the tree) and followed by the symbol itself. The receiver can now know this symbol so that if its codeword arrives later on, it can be properly decoded. The symbol is inserted in the tree by making

the leaf  $L$  with the lowest frequency a nonleaf so that  $L$  has two children, one pertaining to the symbol previously in  $L$  and one to the new symbol.

Adaptive Huffman coding surpasses simple Huffman coding in two respects: It requires only one pass through the input, and it adds only an alphabet to the output. Both versions are relatively fast, and more important, they can be applied to any kind of file, not only to text files. In particular, they can compress object or executable files. The problem with executable files, however, is that they generally use larger character sets than source code files, and the distribution of these characters is more uniform than in text files. Therefore, the Huffman trees are large, the codewords are of similar length, and the output file is not much smaller than the original; it is compressed merely by 10–20 percent.

### 11.3 RUN-LENGTH ENCODING

A *run* is defined as a sequence of identical characters. For example, the string  $s = \text{"aaabba"}$  has three runs: a run of three “a”s followed by runs of two “b”s and one “a.” The run-length encoding technique takes advantage of the presence of runs and represents them in an abbreviated, compressed form.

If runs are of the same characters, as in the string  $s = \text{"nnnn**r%%%%%%"}$ , then instead of transmitting this string, information about runs can be transferred. Each run is coded by the pair  $(n, ch)$ , where  $ch$  is a character and  $n$  is the integer representing the number of consecutive characters  $ch$  in the run. The string  $s$  is coded as  $4n3*1r7\%$ . However, a problem arises if one of the characters being transferred is a digit, as in  $1111111111544444$ , which is represented as  $1111554$  (for eleven 1s, one 5, and five 4s). Therefore, for each run, instead of the number  $n$ , a character can be used whose ASCII value is  $n$ . For example, the run of 43 consecutive letters “c” is represented as  $+c$  (“+” has ASCII code 43), and the run of 49 1s is coded as  $11$  (“1” has ASCII code 49).

This technique is efficient only when at least two-character runs are transmitted, because for one-character runs, the codeword is twice as long as the character. Therefore, the technique should be applied only to runs of at least two characters. This requires using a marker indicating that what is being transmitted is either a run in an abbreviated form or a literal character. Three characters are needed to represent a run: a compression marker  $cm$ , a literal character  $ch$ , and a counter  $n$ , which make up a triple  $\langle cm, ch, n \rangle$ . The problem of choosing the compression marker is especially delicate, because it should not be confused with a literal character being transmitted. If a regular text file is transmitted, then the character ‘~’+1 can be chosen. If there is no restriction on the characters transmitted, then whenever the compression marker itself occurs in the input file, we transmit the compression marker twice. The decoder discards one such marker upon receiving two of them in a row and retains just one as part of the data being received. For example, `%%` in a `printf` statement in C indicates to print just one percent sign. Because for each literal marker two of them must be sent, an infrequently used marker should be chosen. In addition, runs of markers are not sent in compressed form.

Compressing runs results in a sequence of three characters, so this technique should be applied to runs of at least four characters. The maximum length of a run that can be represented by the triple  $\langle cm, ch, n \rangle$  is 255 for 8-bit ASCII if the number  $n$

represents the number of characters in the run. But because only runs of four or more characters are encoded,  $n$  can represent the number of actual characters in the run minus 4; for example, if  $n = 1$ , then there are five characters in the run. In this case, the longest run representable by one triple has 259 characters.

Run-length encoding is only modestly efficient for text files in which only the blank character has a tendency to be repeated. In this case, a predecessor of this technique can be applied, *null suppression*, which compresses only runs of blanks and eliminates the need to identify the character being compressed. As a result, pairs  $\langle cm, n \rangle$  are used for runs of three or more blanks. This simple technique is used in the IBM 3780 BISYNC transmission protocol where throughput gain is between 30 and 50 percent.

Run-length encoding is very useful when applied to files that are almost guaranteed to have many runs of at least four characters. One example is relational databases. All records in the same relational database file have to be of equal length. Records (rows, tuples) are collections of fields, which may be—and most often are—longer than the information stored in them. Therefore, they have to be padded with some character, thereby creating a large collection of runs whose only purpose is to fill up free space in each field of every record.

Another candidate for compression using run-length encoding is fax images, which are composed of combinations of black and white pixels. For low resolution, there are about 1.5 million pixels per page.

A serious drawback of run-length encoding is that it relies entirely on the occurrences of runs. In particular, this method taken by itself is unable to recognize the high frequency of the occurrence of certain symbols that call for short codewords. For example, AAAABBBB can be compressed, because it is composed of two runs, but ABABABAB cannot, although both messages are made up of the same letters. On the other hand, ABABABAB is compressed by Huffman encoding into the same number of codewords as AAAABBBB without taking into consideration the presence of runs. Therefore, it seems appropriate to combine both methods as in this chapter's case study.

## 11.4 ZIV-LEMPER CODE

The problem with some of the methods discussed thus far is that they require some knowledge about the data before encoding takes place. A “pure form” of the Huffman encoder has to know the frequencies of symbol occurrences before codewords are assigned to the symbols. Some versions of the adaptive Huffman encoding can circumvent this limitation, not by relying on previous knowledge of the source characteristics, but by building this knowledge in the course of data transmission. Such a method is called a *universal coding scheme*, and Ziv-Lempel code is an example of a universal data compression code.

In a version of the Ziv-Lempel method called LZ77, a buffer of symbols is maintained. The first  $l_1$  positions hold the  $l_1$  most recently encoded symbols from the input, and the remaining  $l_2$  positions contain the  $l_2$  symbols about to be encoded. In each iteration, starting from one of the first  $l_1$  positions, the buffer is searched for a substring matching a prefix of a string located in the second portion of the buffer. If such a match is found, a codeword is transmitted; the codeword is a triple composed

of the position in which the match was found, the length of the match, and the first mismatching symbol. Then, the entire content of the buffer is shifted to the left by the length of match plus one. Some symbols are shifted out. Some new symbols from the input are shifted in. To initiate this process, the first  $l_1$  positions are filled with  $l_1$  copies of the first symbol of the input.

As an example, consider the case when  $l_1 = l_2 = 4$ , and the input is the string “aababacbaacbaadaaa . . .” Positions in the buffer are indexed with the numbers 0–7. The initial situation is shown at the top of Figure 11.9. The first symbol of the input is “a,” and positions 0 through 3 are filled up with “a”s. The first four symbols of the input, “aaba,” are placed in the remaining positions. The longest prefix matching any substring that begins in any position between 0 and 3 is “aa.” Therefore, the generated codeword is a triple  $\langle 2, 2, b \rangle$ , or simply 22b: The match starts in position two, it is two symbols long, and the symbol following this match is “b.” Next, a left shift occurs, three “a”s are shifted out, and the string “bac” is shifted in. The longest match also starts in position two and is three symbols long, namely, “aba,” with “c” following it. The issued codeword is 23c. Figure 11.9 illustrates a few more steps.

**FIGURE 11.9** Encoding the string “aababacbaacbaadaaa . . .” with LZ77.

Input	Buffer	Code Transmitted
aababacbaacbaadaa . . .	aaaa	a
aababacbaacbaadaa . . .	aaaaaaba	22b
abacbaacbaadaaa . . .	aaababac	23c
baacbaadaaa . . .	abacbaac	12a
cbaadaaa . . .	cbaacbaa	03a
dadaa . . .	cbaadaaa	30d
aaa . . .	. . .	

The numbers  $l_1$  and  $l_2$  are chosen in this example so that only 2 bits are needed for each. Because each symbol requires 1 byte (8 bits), one codeword can be stored in 12 bits. Therefore,  $l_1$  and  $l_2$  should be powers of 2, so that no binary number is unused. If  $l_1$  is 5, then 3 bits are needed to code all possible positions 0 through 4, and the 3-bit combinations corresponding to the numbers 5, 6, and 7 are not used.

A more frequently applied version of Ziv-Lempel algorithm called LZW uses a table of codewords created during data transmission. A simple algorithm for encoding can be presented as follows (Miller and Wegman, 1985; Welch, 1984):

```
LZWcompress (
    enter all letters to the table;
    initialize string s to the first letter from input;
    while any input left
```

```

read character c;
if s+c is in the table
    s = s+c;
else output codeword(s);
    enter s+c to the table;
    s = c;
output codeword(s);

```

String  $s$  is always at least one character long. After reading a new character, the concatenation of string  $s$  and character  $c$  is checked in the table. A new character is read if the concatenation  $s+c$  is in the table. If it is not, the codeword for  $s$  is output, the concatenation  $s+c$  is stored in the table, and  $s$  is initialized to  $c$ . Figure 11.10 shows a trace of the execution of this procedure applied to the input “aababacbaacbaadaaa . . .” The figure contains the generated output, the strings included in the table in full form and in abbreviated form, represented by a number and a character.

**FIGURE 11.10** LZW applied to the string “aababacbaacbaadaaa . . .”

Encoder		Index (Codeword)	Table	
Input	Output		Full String	Abbreviated String
		1	a	a
		2	b	b
		3	c	c
a		4	d	d
a	1	5	aa	1a
b	1	6	ab	1b
ab	2	7	ba	2a
a	6	8	aba	6a
c	1	9	ac	1c
ba	3	10	cb	3b
ac	7	11	baa	7a
baa	9	12	acb	9b
d	11	13	baad	11d
aa	4	14	da	4a
a	5	15	aaa	5a
	...			

A crucial component of efficiency is the organization of the table. Clearly, for more realistic examples, hundreds and thousands of entries can be expected in this table so that an efficient searching method has to be used. A second concern is the size of the table, which grows particularly when new long strings are entered in it. The problem of size is addressed by storing in the table codewords for the prefix and the last characters of strings. For example, if “ba” is assigned the codeword 7, then “baa” can be stored in the table as a number of its prefix, “ba,” and the last character, “a,” that is, as 7a. In this way, all table entries have the same length. The problem of searching is addressed by using a hash function.

For decoding, the same table is created by updating it for each incoming codeword except the first. For each codeword, a corresponding prefix and a character are retrieved from the table. Because the prefix is also a codeword (except for single characters), it requires another table lookup, as the entire string is decoded. This is clearly a recursive procedure that may be implemented with an explicit stack. This is necessary because the decoding process applied to prefixes yields a string in the reverse order. The decoding procedure can be summarized as follows:

```
LZWdecompress()
  enter all letters to the table;
  read priorcodeword and output one character corresponding to it;
  while codewords are still left
    read codeword;
    if codeword is not in the table // special case: c+s+c+s+c, also if s is null;
      enter in table string(priorcodeword) + firstchar(string(priorcodeword));
      output string(priorcodeword) + firstchar(string(priorcodeword));
    else enter in table string(priorcodeword) + firstchar(string(codeword));
      output string(codeword);
    priorcodeword = codeword;
```

This relatively simple algorithm has to consider a special case, when a codeword being processed has no corresponding entry in the table. This situation arises when the string being decoded contains a substring “cScSc,” where “c” is a single character, and “cS” is already in the table.

All of the discussed compression algorithms are widely used. UNIX has three compression programs: *pack* uses the Huffman algorithm, *compact* is based on the adaptive Huffman method, and *compress* uses LZW coding. According to system manuals, *pack* compresses text files by 25–40 percent, *compact* by 40 percent, and *compress* by 40–50 percent. The rate of compression is better for Ziv-Lempel coding. It is also faster.

## 11.5

### CASE STUDY: HUFFMAN METHOD WITH RUN-LENGTH ENCODING

As indicated in the discussion of run-length encoding, this method is suitable for files that are almost guaranteed to have many runs of at least four symbols; otherwise, no compression is achieved. The Huffman algorithm, on the other hand, can be applied

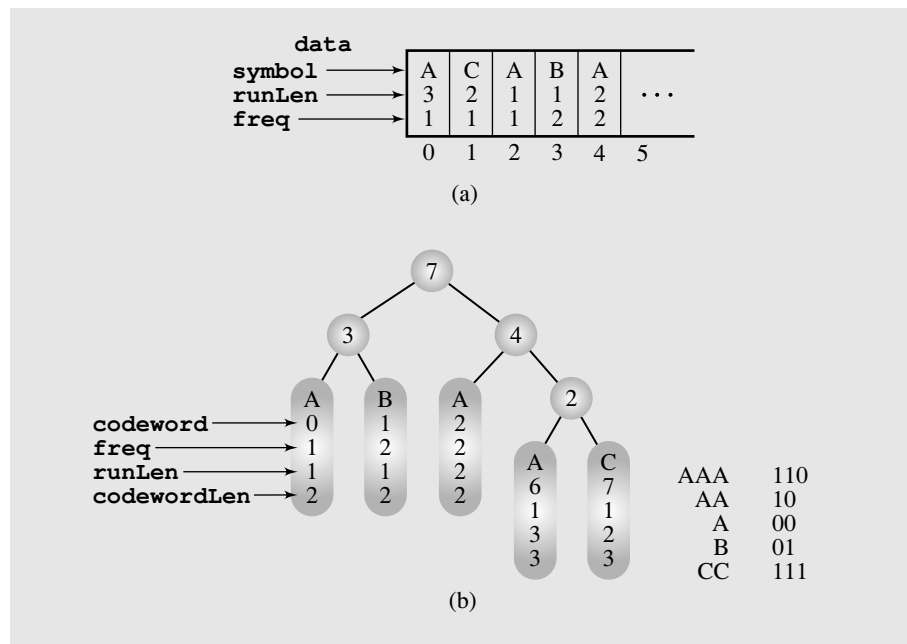


to files with any runs, including runs of one to three symbols long. This method can be applied to single symbols, such as letters, but also to pairs of symbols, to triples, and to a collection of variable length sequences of symbols. Incorporating run-length encoding in the Huffman method works exceedingly well for files with many long runs and moderately well for files with a small number of runs and a large number of different symbols.

For files with no runs, this method is reduced to plain Huffman encoding. In this approach, a file to be compressed is scanned first to determine all runs, including one-, two-, and three-symbols long runs. Runs composed of the same symbols but of different lengths are treated as different “super-symbols,” which are used to create a Huffman tree. For example, if the message to be compressed is AAABAACCAABA, then the super-symbols included in the Huffman tree are AAA, B, AA, CC, and A, and not symbols A, B, and C. In this way, the number of codewords to be created grows from three for the symbols to five for the super-symbols. The conversion table becomes larger, but the codewords assigned to the runs are much shorter than in straight run-length encoding. In run-length encoding, this codeword is always 3 bytes long (24 bits). In Huffman code, it may be even 1 bit long.

First, an input file is scanned and all super-symbols are collected in the array list `data` by the method `gatherData()` and sorted according to the frequency of occurrence. Figure 11.11a illustrates the positions of the data in the sorted array list. Next, the sorted data are stored in the output file to be used by the decoder to create the

**FIGURE 11.11** (a) Contents of the array `data` after the message AAABAACCAABA has been processed. (b) Huffman tree generated from these data.



same Huffman tree that the encoder is about to create. `createHuffmanTree()` generates the tree of Huffman codewords using information collected in `data`. To that end, a doubly linked list of single node trees similar to the list in Figure 11.3 is created first. Then, repeatedly, the two trees with the lowest frequencies are combined to create one tree, which eventually results in one Huffman tree, as in Figure 11.11b.

After the tree has been created, the positions of all nodes, in particular the leaves, can be determined whereby the codewords of all symbols in the leaves can be generated. Each node in this tree has seven data members, but only five of them are shown, just for leaves. The codewords are stored as numbers that represent binary sequences of 0s and 1s. For example, the codeword for `CC` is 7, 111 in binary. However, these numbers are always the same length, and 7 is stored as 3 bits set to 1 preceded by 29 bits set to 0, 0 . . . 0111. It is, therefore, unclear how many bits out of 32 are included in the sequence representing the codeword for a certain symbol. Is it 111, 0111, 00111, or some other sequence? The codeword for single `As` is 0. Is the codeword for `A` 0, 00, 000, or some more 0s? To avoid ambiguity, the `codewordLen` field stores the number of bits included in the codeword for a given symbol. `codewordLen` for `A` is 2 and `codeword` is 0, so the codeword sequence representing `A` is 00.

After the Huffman tree is generated and the leaves are filled with relevant information, the process of coding information in the input file can be initiated. Because searching for particular symbols directly in the tree is too time-consuming, an array `chars[]` of linked lists corresponding to each ASCII symbol is created. The nodes of the linked lists are simply leaves of the tree linked through right references, and each list has as many nodes as the number of different run lengths of a given symbol in the input file. It gives immediate access to a particular linked list, but some linked lists may be long if there are many run lengths of a given symbol.

Next, the file is scanned for the second time to find each super-symbol and its corresponding codeword in the Huffman tree and to transmit it to the output file. As the sequences are retrieved from the tree, they are tightly packed into a 4-byte numerical variable `pack`. The first encountered super-symbol in the input file is `AAA` with codeword 110, which is stored in `pack` so that `pack` contains the sequence 0 . . . 0110. After `B` is retrieved from the file, its code, 01, is attached to the end of `pack`. As a result, the contents of `pack` have to be shifted to the left by two positions to make room for 01, and then 01 is stored in it using the bitwise-or operation `|`. Now, `pack` contains the string 0 . . . 011001. After `pack` is filled up with codewords, it is output as a sequence of 4 bytes to the output file.

Particular care has to be taken to put exactly 32 bytes in `pack`. When there are fewer available positions in `pack` than the number of bits in a codeword, only a portion of the codeword is put in `pack`. Then `pack` is output and the remaining portion of the codeword is put in `pack` before any other symbol is encoded. For example, if `pack` currently contains 001 . . . 10011, `pack` can take only two more bits. Because the codeword 1101 is 4 bits long, the contents of `pack` are shifted to the left by two positions, 1 . . . 1001100, and the first two bits of the codeword, 11, are put at the end of `pack`, after which `pack`'s contents are 1 . . . 1001111. Next, `pack` is output as 4 bytes (characters), and then the remaining 2 bits of the codeword, 01, are put into `pack`, which now contains 0 . . . 001.

Another problem is with the last codewords. The encoder fills the output file with bytes (in this case, with chunks of 4 bytes), each containing 8 bits. What happens if

there are no symbols left, but there is still room in `pack`? The decoder has to know that some bits at the end of the file should not be decoded. If they are, some spurious characters will be added to the decoded file. In this implementation, the problem is solved by transmitting at the beginning of the encoded file the number of characters to be decoded. The decoder decodes only this number of codewords. Even if some bits are left in the encoded file, they are not included in the decoding process. This is a problem that arises in our example. The message `AAABAACCAABA` is encoded as the sequence of codewords `110, 01, 10, 111, 10, 01, 00`, and the contents of `pack` are `00000000000000001100110111100100`. If the encoding process is finished, the contents are shifted to the left by the number of unused bits, whereby `pack` becomes `11001101111001000000000000000000` and is output as a sequence of 4 bytes, `11001101, 1100100, 00000000, and 00000000` or, in more readable decimal notation, as `205, 228, 0, and 0`. The last 16 bits do not represent any codewords, and if it is not indicated, they are decoded as eight As, whose codeword is `00`. To prevent this, the output file includes the number of encoded characters, namely, `12: A, A, A, B, A, A, C, C, A, A, B, and A`. The output file also includes the number of all symbols in the Huffman tree. For this example, it is the number `5`, because five different super-symbols can be found in the input file and in the Huffman tree: `AAA, B, AA, CC, and A`. Therefore, the structure of the output file is as follows: the number of super-symbols, `data.Size()`, number of characters, contents of `data` (symbols, run lengths, and frequencies), and codewords of all super-symbols found in the input file.

The decoder is much simpler than the encoder because it uses information supplied by the encoder in the header of the encoded message. The decoder re-creates first the array list `data[]` in `inputFrequencies()`, then reconstructs the Huffman tree with the same `createHuffmanTree()` and `createCodewords()` decoder used, and finally, in `decode()`, scans the tree in the order determined by the stream of bits in the compressed file to find in its leaves the encrypted symbols.

As expected, this implementation gives particularly good results for database files, with a compression rate of 60 percent. The compression rate for LISP files is 50 percent (runs of parentheses); for text files, 40 percent; and for executable files, merely 13 percent.

Figure 11.12 contains the complete code for the encoder.

**FIGURE 11.12** Implementation of Huffman method with run-length encoding.

```
//***** HuffmanCoding.java *****
import java.io.*;

class HuffmanNode {
    public byte symbol;
    public int codeword;
    public int freq;
    public int runLen;
}
```

*Continues*

**FIGURE 11.12** (continued)

```

    public int codewordLen;
    public HuffmanNode left = null, right = null;
    public HuffmanNode() {
    }
    public HuffmanNode(byte s, int f, int r) {
        this(s,f,r,null,null);
    }
    public HuffmanNode(byte s, int f, int r, HuffmanNode lt, HuffmanNode rt) {
        symbol = s; freq = f; runLen = r; left = lt; right = rt;
    }
}

class ListNode {
    public HuffmanNode tree;
    public ListNode next = null, prev = null;
    public ListNode() {
    }
    public ListNode(ListNode p, ListNode n) {
        prev = p; next = n;
    }
}

class DataRec implements Comparable {
    public byte symbol;
    public int runLen;
    public int freq;
    public DataRec() {
    }
    public DataRec(byte s, int r) {
        symbol = s; runLen = r; freq = 1;
    }
    public boolean equals(Object el) {
        return symbol == ((DataRec)el).symbol && runLen == ((DataRec)el).runLen;
    }
    public int compareTo(Object el) {
        return freq - ((DataRec)el).freq;
    }
}

class HuffmanCoding {
    public HuffmanCoding() {
    }
    private final int ASCII = 256,

```

**FIGURE 11.12** (continued)

```

        intBytes = 4, // bytes per int;
        bits = 8;    // bits per byte;
private HuffmanNode HuffmanTree;
private HuffmanNode[] chars = new HuffmanNode[ASCII + 1];
private java.util.ArrayList data = new java.util.ArrayList();
private long charCnt;

private void error(String s) {
    System.err.println(s); System.exit(-1);
}

private void garnerData(RandomAccessFile fIn) throws IOException {
    int ch, ch2, runLen, i;
    for (ch = fIn.read(); ch != -1; ch = ch2) {
        for (runLen = 1, ch2 = fIn.read(); ch2 != -1 && ch2 == ch; runLen++)
            ch2 = fIn.read();
        DataRec r = new DataRec((byte)ch, runLen);
        if ((i = data.indexOf(r)) == -1)
            data.add(r);
        else ((DataRec)data.get(i)).freq++;
    }
    java.util.Collections.sort(data);
}

private void outputFrequencies(RandomAccessFile fIn, RandomAccessFile fOut)
    throws IOException {
    fOut.writeInt(data.size());
    fOut.writeLong(fIn.getFilePointer());
    for (int j = 0; j < data.size(); j++) {
        DataRec r = (DataRec)data.get(j);
        fOut.write(r.symbol);
        fOut.writeInt(r.runLen);
        fOut.writeInt(r.freq);
    }
}

private void inputFrequencies(RandomAccessFile fIn) throws IOException {
    int dataIndex = fIn.readInt();
    charCnt = fIn.readLong();
    data.ensureCapacity(dataIndex);
    for (int j = 0; j < dataIndex; j++) {
        DataRec r = new DataRec();

```

*Continues*

**FIGURE 11.12** *(continued)*

```

        r.symbol = (byte) fIn.read();
        r.runLen = fIn.readInt();
        r.freq = fIn.readInt();
        data.add(r);
    }
}

private void createHuffmanTree() {
    ListNode p, newNode, head, tail;
    head = tail = new ListNode();           // initialize list pointers;
    DataRec r = (DataRec)data.get(0);
    head.tree = new HuffmanNode(r.symbol,r.freq,r.runLen);
    for (int i = 1; i < data.size(); i++) { // create the rest of the list;
        tail.next = new ListNode(tail,null);
        tail = tail.next;
        r = (DataRec)data.get(i);
        tail.tree = new HuffmanNode(r.symbol,r.freq,r.runLen);
    }
    while (head != tail) {                  // create one Huffman tree;
        int newFreq = head.tree.freq + head.next.tree.freq; // two lowest
                                                                // frequencies
        for (p = tail; p != null && p.tree.freq > newFreq; p = p.prev);
        newNode = new ListNode(p,p.next);
        p.next = newNode;
        if (p == tail)
            tail = newNode;
        else newNode.next.prev = newNode;
        newNode.tree =
            new HuffmanNode((byte)0,newFreq,0,head.tree,head.next.tree);
        head = head.next.next;
        head.prev = null;
    }
    HuffmanTree = head.tree;
}

private void createCodewords(HuffmanNode p, int codeword, int lvl) {
    if (p.left == null && p.right == null) { // if p is a leaf,
        p.codeword = codeword;                // store codeword
        p.codewordLen = lvl;                  // and its length,
    }
    else {
        createCodewords(p.left, codeword<<1, lvl+1); // otherwise add 0
                                                    // for left branch
    }
}

```

**FIGURE 11.12** (continued)

```

        createCodewords(p.right,(codeword<<1)+1,lvl+1);// and 1 for right;
    }
}

private void transformTreeToArrayOfLists(HuffmanNode p) {
    if (p.left == null && p.right == null) { // if p is a leaf,
        p.right = chars[p.symbol+128]; // include it in
        chars[p.symbol+128] = p; // a list associated
    } // with symbol found in p;
    else { // add 128 to change the
        transformTreeToArrayOfLists(p.left); // range of bytes from
        transformTreeToArrayOfLists(p.right); // [-128, 127] to
    } // [0, 255];
}

private void encode(RandomAccessFile fIn, RandomAccessFile fOut) throws
IOException {
    int packCnt = 0, hold, maxPack = 4 * bits, pack = 0;
    int ch, ch2, bitsLeft, runLen;
    HuffmanNode p;
    for (ch = fIn.read(); ch != -1; ) {
        for (runLen = 1, ch2 = fIn.read(); ch2 != -1 && ch2 == ch; runLen++)
            ch2 = fIn.read();
        for (p = chars[(byte)ch+128]; p != null && runLen != p.runLen;
            p = p.right)
            ;
        if (p == null)
            error("A problem in transmitCode()");
        if (p.codewordLen < maxPack - packCnt) { // if enough room in
            pack = (pack << p.codewordLen) | p.codeword; // pack to store
            packCnt += p.codewordLen; // new codeword, shift its
        } // content to the left
        // and attach new codeword;
    else { // otherwise move
        bitsLeft = maxPack - packCnt; // pack's content to
        pack <<= bitsLeft; // the left by the
        if (bitsLeft != p.codewordLen) { // number of left
            hold = p.codeword; // spaces and if new
            hold >>= p.codewordLen - bitsLeft; // codeword is longer
            pack |= hold; // than room left, transfer
        } // only as many bits as
        // can fit in pack;
    }
}

```

*Continues*

**FIGURE 11.12** (continued)

```

        else pack |= p.codeword;           // if new codeword
                                           // exactly fits in
                                           // pack, transfer it;
fOut.writeInt(pack);                       // output pack as
                                           // four bytes;
if (bitsLeft != p.codewordLen) {          // transfer
    pack = p.codeword;                     // unprocessed bits
    packCnt = maxPack - (p.codewordLen - bitsLeft); // of new
    packCnt = p.codewordLen - bitsLeft; // codeword to pack;
}
else packCnt = 0;
    }
    ch = ch2;
}
if (packCnt != 0) {
    pack <<= maxPack - packCnt; // transfer leftover codewords
    fOut.writeInt(pack);        // and some 0's;
}
}

public void compressFile(String inFileName, RandomAccessFile fIn) throws
IOException {
    String outFileName = new String(inFileName+".z");
    RandomAccessFile fOut = new RandomAccessFile(outFileName,"rw");
    Date start = new Date();
    garnerData(fIn);
    outputFrequencies(fIn,fOut);
    createHuffmanTree();
    createCodewords(HuffmanTree,0,0);
    for (int i = 0; i <= ASCII; i++)
        chars[i] = null;
    transformTreeToArrayOfLists(HuffmanTree);
    fIn.seek(0);
    encode(fIn,fOut);
}

private void decode(RandomAccessFile fIn, RandomAccessFile fOut) throws
IOException {
    int chars, j, ch, bitCnt = 1, mask = 1;
    mask <<= bits - 1; // change 00000001 to 10000000
    for (chars = 0, ch = fIn.read(); ch != -1 && chars < charCnt; ) {
        for (HuffmanNode p = HuffmanTree; ; ) {
            if (p.left == null && p.right == null) {
                for (j = 0; j < p.runLen; j++)

```



**FIGURE 11.12** (continued)

```

        fOut.write(p.symbol);
        chars += p.runLen;
        break;
    }
    else if ((ch & mask) == 0)
        p = p.left;
    else p = p.right;
    if (bitCnt++ == bits) { // read next character from fIn
        ch = fIn.read(); // if all bits in ch are checked;
        bitCnt = 1;
    }
    // otherwise move all bits in ch
    // to the left by one position;
    else ch <<= 1;
}
}
}

public void decompressFile(String inFileName, RandomAccessFile fIn)
    throws IOException {
    String outFileName = new String(inFileName+".dec");
    RandomAccessFile fOut = new RandomAccessFile(outFileName,"rw");
    Date start = new Date();
    inputFrequencies(fIn);
    createHuffmanTree();
    createCodewords(HuffmanTree,0,0);
    for (int i = 0; i <= ASCII; i++)
        chars[i] = null;
    decode(fIn,fOut);
}
}

//***** HuffmanEncoder.java *****

import java.io.*;

public class HuffmanEncoder {
    static public void main (String args[]) {
        String fileName = "";
        HuffmanCoding Htree = new HuffmanCoding();
        RandomAccessFile fIn;
        InputStreamReader isr = new InputStreamReader(System.in);
        BufferedReader buffer = new BufferedReader(isr);
        try {

```

*Continues*

**FIGURE 11.12** (continued)

```

        if (args.length == 0) {
            System.out.print("Enter a file name: ");
            fileName = buffer.readLine();
            fIn = new RandomAccessFile(fileName,"r");
        }
        else {
            fIn = new RandomAccessFile(args[0],"r");
            fileName = args[0];
        }
        Htree.compressFile(fileName,fIn);
        fIn.close();
    } catch(IOException io) {
        System.err.println("Cannot open " + fileName);
    }
}
}

//***** HuffmanDecoder.java *****

import java.io.*;

public class HuffmanDecoder {
    static public void main (String args[]) {
        String fileName = "";
        HuffmanCoding Htree = new HuffmanCoding();
        RandomAccessFile fIn;
        InputStreamReader isr = new InputStreamReader(System.in);
        BufferedReader buffer = new BufferedReader(isr);
        try {
            if (args.length == 0) {
                System.out.print("Enter a file name: ");
                fileName = buffer.readLine();
                fIn = new RandomAccessFile(fileName,"r");
            }
            else {
                fIn = new RandomAccessFile(args[0],"r");
                fileName = args[0];
            }
            Htree.decompressFile(fileName,fIn);
            fIn.close();
        } catch(IOException io) {
            System.err.println("Cannot open " + fileName);
        }
    }
}
}

```

## 11.6

## EXERCISES

1. For which probabilities  $P(m_i)$  of  $n$  symbols is the average length maximal? When is it minimal?
2. Find  $L_{\text{ave}}$  for the letters X, Y, and Z and their probabilities .05, .05, and .9 and compare it to  $L_{\text{Huf}}$  computed for single letters and pairs of letters, as in Figure 11.6. Does  $L_{\text{Huf}}$  satisfactorily approximate  $L_{\text{ave}}$ ? How can we remedy the problem?
3. Assess the complexity of all the implementations of the Huffman algorithm suggested in this chapter.
4. What are the lengths of the Huffman codewords of the least probable messages with respect to each other?
5. In the adaptive Huffman algorithm, first the codeword for an encountered symbol is issued and then the conversion table is updated. Could the table be updated first and then the new codeword for this symbol be issued? Why or why not?
6. The methods `createCodewords()` and `transformTreeToArrayOfLists()` used in the case study seem to be vulnerable because the first thing they both do is access the field `left` of node `p`, which would be dangerous if `p` were null; therefore, the body of both methods should apparently be preceded by the condition `if (p != null)`. Explain why this is not necessary.
7. What problem arises if, in run-length encoding, triples of the form  $\langle cm, n, ch \rangle$  are used instead of triples of the form  $\langle cm, ch, n \rangle$ ?
8. In Figure 11.9,  $l_1 = l_2 = 4 = 2^2$ . In what respect does the choice of  $l_1 = l_2 = 16 = 2^4$  simplify the implementation of LZ77?
9. In which situation does LZ77 perform best? Worst?
10. Describe the process of decoding using LZ77. What string is coded by this sequence of codewords: b, 31a, 23b, 30c, 21a, 32b?
11. Using LZW with the table initialized with the letters a, b, c, decode the string coded as 1 2 4 3 1 4 9 5 8 12 2.

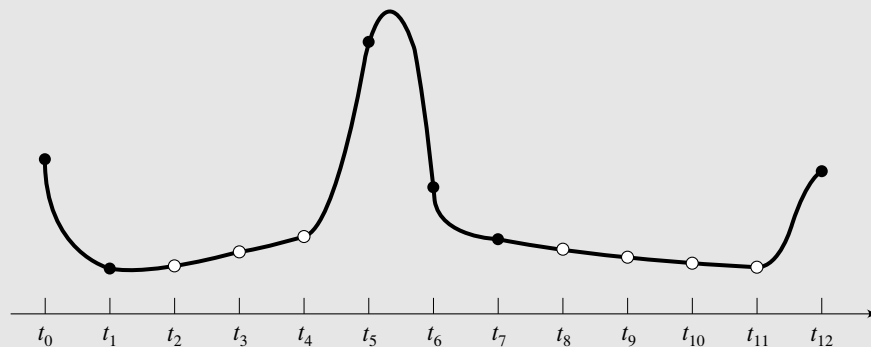
## 11.7

## PROGRAMMING ASSIGNMENTS

1. A large number of messages with very low probabilities in a long series of messages require a large number of very long codewords (Hankamer, 1979). Instead, one codeword can be assigned to all these messages, and if needed, this codeword is sent along with the message. Write a program for coding and decoding this approach by adapting the Huffman algorithm.
2. Write an encoder and a decoder that use the run-length encoding technique.

3. Write an encoder and a decoder using run-length encoding to transmit voice, with the voice simulated by a certain function  $f$ . Voice is generated continuously, but it is measured at  $t_0, t_1, \dots$ , where  $t_i - t_{i-1} = \delta$ , for some time interval  $\delta$ . If  $|f(t_i) - f(t_{i-1})| < \epsilon$  for some tolerance  $\epsilon$ , then the numbers  $f(t_i)$  and  $f(t_{i-1})$  are treated as equal. Therefore, for runs of such equal values, a compressed version can be transmitted in the form of a triple  $\langle cm, f(t_i), n \rangle$  with  $cm$  being a negative number. In Figure 11.13, circles represent the numbers included in a run indicated by the first preceding bullet; in this example, two runs are sent. What is a potential danger of this technique, known also as the *zero-order predictor*? How can this be solved? Try your program on the functions  $\frac{\sin n}{n}$  and  $\ln n$ .

**FIGURE 11.13** A function representing voice frequency.



4. Static dictionary techniques are characterized by using a predefined dictionary of patterns encoded with unique codewords. After a dictionary is established, the problem of using it most efficiently still remains. For example, for a dictionary = {ability, ility, pec, re, res, spect, tab}, the word *respectability* can be broken down in two ways: *res, pec, tab, ility* and *re, spect, ability*; that is, the first division requires four codewords for this word, whereas the second requires only three. The algorithm parses the word or words and determines which of the two choices will be made. Of course, for a large dictionary, there may be more than two possible parsings of the same word or phrase. By far the most frequently used technique is a *greedy algorithm* that finds the longest match in the dictionary. For our example, the match *res* is longer than *re*; therefore, the word *respectability* is divided into four components with the greedy strategy. An optimal parsing can be found by adapting a shortest path algorithm. (Bell, Cleary, and Witten, 1990; Schuegraf and Heaps, 1974). Write a program that for a dictionary of patterns compresses a text file. For each string  $s$ , create a digraph with  $s.length$  nodes. Edges are labeled with the dictionary patterns, and their codeword lengths are edges' costs. Two nodes  $i$  and  $j$  are connected with an edge if the dictionary contains a pattern  $s.charAt(i) \dots s.charAt(j-1)$ . The shortest path represents the shortest sequences of codewords for patterns found in the path.

## BIBLIOGRAPHY

### *Data Compression Methods*

Bell, Timothy C., Cleary, J. G., and Witten, Ian H., *Text Compression*, Englewood Cliffs, NJ: Prentice Hall, 1990.

Drozdek, Adam, *Elements of Data Compression*, Pacific Grove, CA: Brooks/Cole, 2002.

Lelever, Debra A., and Hirschberg, Daniel S., "Data Compression," *ACM Computing Surveys* 19 (1987), 261–296.

Rubin, Frank, "Experiments in Text File Compression," *Communications of the ACM* 19 (1976), 617–623.

Salomon, David, *Data Compression: The Complete Reference*, New York: Springer, 2000.

Schuegraf, E. J., and Heaps, H. S., "A Comparison of Algorithms for Data-Base Compression by Use of Fragments as Language Elements," *Information Storage and Retrieval* 10 (1974), 309–319.

### *Huffman Coding*

Cormack, Gordon V., and Horspool, R. Nigel, "Algorithms for Adaptive Huffman Codes," *Information Processing Letters* 18 (1984), 159–165.

Faller, Newton, "An Adaptive System for Data Compression," *Conference Record of the Seventh IEEE Asilomar Conference on Circuits, Systems, and Computers*, San Francisco: IEEE (1974), 593–597.

Gallager, Robert G., "Variations on a Theme of Huffman," *IEEE Transactions on Information Theory* IT-24 (1978), 668–674.

Hankamer, M., "A Modified Huffman Procedure with Reduced Memory Requirement," *IEEE Transactions on Communication* COM-27 (1979), 930–932.

Huffman, David A., "A Method for the Construction of Minimum-Redundancy Codes," *Proceedings of the Institute of Radio Engineers* 40 (1952), 1098–1101.

Knuth, Donald E., "Dynamic Huffman Coding," *Journal of Algorithms* 6 (1985), 163–180.

### *Run-Length Encoding*

Pountain, Dick, "Run-Length Encoding," *Byte* 12 (1987), No. 6, 317–320.

### *Ziv-Lempel Code*

Miller, Victor S., and Wegman, Mark N., "Variations on a Theme by Ziv and Lempel," in Apostolico, A., and Galil, Z. (eds.), *Combinatorial Algorithms on Words*, Berlin: Springer (1985), 131–140.

Welch, Terry A., "A Technique for High-Performance Data Compression," *Computer* 17 (1984), 6, 8–19.

Ziv, Jacob, and Lempel, Abraham, "A Universal Algorithm for Sequential Data Compression," *IEEE Transactions on Information Theory* IT-23 (1977), 337–343.

# 12

# Memory Management

The preceding chapters rarely looked behind the scenes to see how programs are actually executed and how variables of different types are stored. The reason is that this book emphasizes data structures rather than the inner workings of the computer. The latter belongs more to a book about operating systems or assembly language programming than to a discussion of data structures.

But at least in one case, such a reference was inescapable, namely, when discussing recursion in Chapter 5. Using recursion was explained in terms of the runtime stack and how a computer actually works.

The *heap* is the region of main memory from which portions of memory are dynamically allocated upon request of a program. (This heap has nothing to do with the special tree structure called a heap in Section 6.9.) In languages such as FORTRAN, COBOL, or BASIC, the compiler determines how much memory is needed to run programs. In languages that allow dynamic memory allocation, the amount of memory required cannot always be determined prior to the program run. To that end, the heap is used. If a C program requests memory by issuing `malloc()` or `calloc()` and a C++ or Java program does it by issuing a call to `new`, a certain amount of bytes is allocated from the heap, and the address to the first byte of this portion is returned. Also, in these languages, unused memory has to be specifically released by the programmer through `dispose()` in Pascal, `free()` in C, and `delete` in C++. In some languages, there is no need to explicitly release memory. Unused memory is simply abandoned and then automatically reclaimed by the operating system. Automatic storage reclamation is a luxury that is not part of every language environment. It emerged with LISP and it is part of functional languages, but logic languages and most object-oriented languages, including Smalltalk, Prolog, Modula-3, and Eiffel, also have automatic storage reclamation.

The maintenance of free memory blocks, assigning specific memory blocks to the user programs if necessary and cleaning memory from unneeded blocks to return them to the memory pool, is performed by a part of the operating system called a *memory manager*. The memory manager also performs other functions, such as scheduling access to shared data, moving code and data between main and secondary memory, and keeping one process away from another. This is particularly important in the

multiprogramming system, where many different processes can reside in memory at the same time and the CPU serves for a brief amount of time each of the processes in turn. The processes are put in memory in free spaces and removed if either space is needed for other processes to be served or they've completed execution.

One problem that a well-designed memory manager has to solve is that of the configuration of available memory. In particular, after many allocations and deallocations, the heap is divided into small pieces of available memory sandwiched between chunks of memory in use. If a request comes to allocate  $n$  bytes of memory, the request may not be met if there is not enough contiguous memory in the heap, although the total of available memory may far surpass  $n$ . This phenomenon is called *external fragmentation*. Changing memory configuration and, in particular, putting available memory in one part of the heap and allocated memory in another solve this problem. Another problem is *internal fragmentation*, when allocated memory chunks are larger than requested. External fragmentation amounts to the presence of wasted space between allocated segments of memory; internal fragmentation amounts to the presence of unused memory inside the segments.

## 12.1 THE SEQUENTIAL-FIT METHODS

A simple organization of memory could require a linked list of all memory blocks, which is updated after a block is either requested or returned. The blocks on such linked lists can be organized in a variety of ways, according to the block sizes or the block addresses. Whenever a block is requested, a decision has to be made concerning which block to allocate and how to treat the portion of the block exceeding the requested size.

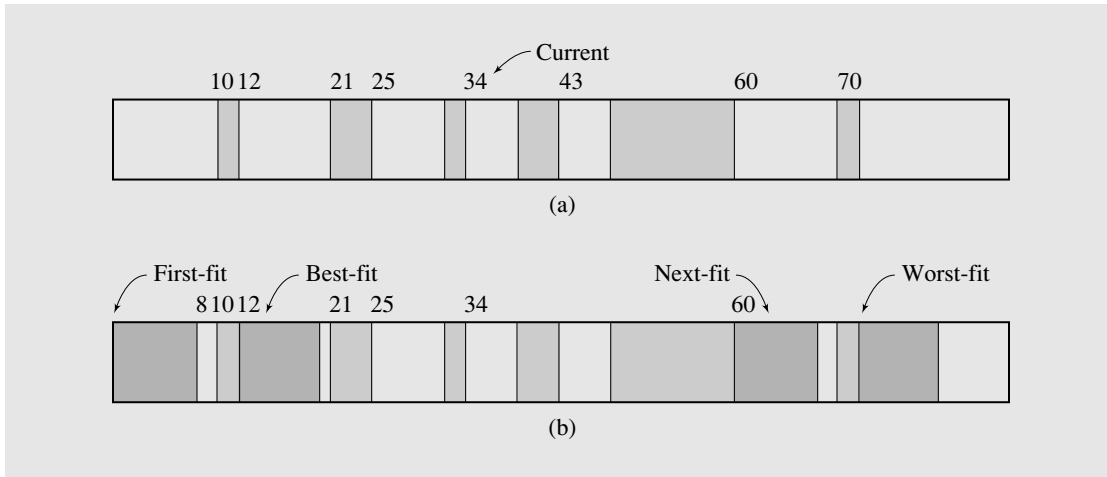
For reasons of efficiency, doubly linked lists of blocks are maintained with links residing in the blocks. Each available block of memory uses a portion of itself for two links. Also, both available and reserved blocks have two fields to indicate their status (available or reserved) and their size.

In the sequential-fit methods, all available memory blocks are linked, and the list is searched to find a block whose size is larger than or the same as the requested size. A simple policy for handling returned blocks of memory is to coalesce them with neighboring blocks and reflect this fact by properly adjusting the links in the linked list.

The order of searching the list for such a block determines the division of these methods into several categories. The *first-fit* algorithm allocates the first block of memory large enough to meet the request. The *best-fit* algorithm allocates a block that is closest in size to the request. The *worst-fit* method finds the largest block on the list so that, after returning its portion equal to the requested size, the remaining part is large enough to be used in later requests. The *next-fit* method allocates the next available block that is sufficiently large.

Figure 12.1a contains a memory configuration after several requests and returns of memory blocks. Figure 12.1b illustrates which portion of memory would be allocated by which sequential-fit method to satisfy a request for 8KB of memory.

The most efficient method is the first-fit procedure. The next-fit method is of comparable speed but causes more extensive external fragmentation because it scans

**FIGURE 12.1** Memory allocation using sequential-fit methods.

the list of blocks starting from the current position and reaches the end of the list much earlier than the first-fit method. But the best-fit algorithm is even worse in that respect because it searches for the closest match with respect to size. The parts of blocks remaining after returning the required size are small and practically unusable. The worst-fit algorithm attempts to prevent this type of fragmentation by avoiding, or at least delaying, the creation of small blocks.

The way the blocks are organized on the list determines how fast the search for an available block succeeds or fails. For example, to optimize the best-fit and the worst-fit methods, the blocks should be arranged by size. For other methods, the address ordering is adequate.

## 12.2 THE NONSEQUENTIAL-FIT METHODS

The sequential-fit methods being what they are, they may become inefficient for large memory. In the case of large memory, a nonsequential search is desirable. One strategy divides memory into an arbitrary number of lists, each list holding blocks of the same size (Ross, 1967). Larger blocks are split into smaller blocks to satisfy requests, and new lists may be created. Because the number of such lists can become large, they can be organized as a tree.

Another approach is based on the observation that the number of sizes requested by a program is limited, although the sizes may differ from one program to another. Therefore, the lists of blocks of different sizes can be kept short if it can be determined which sizes are the most popular. This leads to an *adaptive exact-fit* technique that dynamically creates and adjusts storage block lists that fit the requests exactly (Oldehoeft and Allan, 1985).



In adaptive exact-fit, a size-list of block lists of a particular size returned to the memory pool during the last  $T$  allocations is maintained. A block  $b$  is added to a particular block list if this block list holds blocks of  $b$ 's size and  $b$  has been returned by the program. When a request comes for a block of  $b$ 's size, a block from its block list is detached to meet the request; otherwise, a more time-consuming search for a block in memory is triggered using one of the sequential-fit methods.

The exact-fit method disposes of entire block lists if no request comes for a block from this list in the last  $T$  allocations. In this way, lists of infrequently used block sizes are not maintained, and the list of block lists is kept small to allow a sequential search of this list. Because it is not a sequential search of the memory, the exact-fit method is not considered a sequential-fit method.

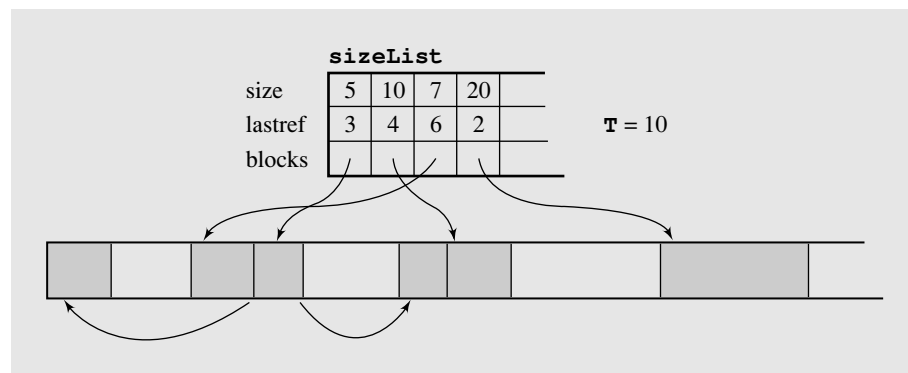
Figure 12.2 contains an example of a size-list and a heap created using the adaptive exact-fit method. The memory is fragmented, but if a request comes for a block of size 7, the allocation can be done immediately, because the size-list has an entry for size 7; thus, memory does not have to be searched. A simple algorithm for allocating blocks is as follows:

```

t = 0;
allocate (reqSize)
  t++;
  if a block list b1 with reqSize blocks is on sizeList
    lastref(b1) = t;
    b = head of blocks(b1);
    if b was the only block accessible from b1
      detach b1 from sizeList;
    else b = search-memory-for-a-block-of(reqSize);
    dispose of all block lists on sizeList for which t - lastref(b1) < T;
  return b;

```

**FIGURE 12.2** An example configuration of a size-list and heap created by the adaptive exact-fit method.



A procedure for returning blocks is even simpler.

This algorithm highlights the problem of memory fragmentation. The algorithm must be expanded to deal with this problem successfully. One solution is to write a method to compact memory after a certain number of allocations and deallocations. A noncompacting approach may consist in liquidating the size-list and building it anew after some predetermined period. The authors of this method claim that fragmentation problems “failed to materialize,” but that can be attributed to the configurations of their tests. Such problems certainly materialize in sequential-fit methods and in another nonsequential-fit strategy to be discussed in the next section.

### 12.2.1 Buddy Systems

Nonsequential memory management methods known as *buddy systems* do not just assign memory in sequential slices, but divide it into two buddies that are merged whenever possible. In the buddy system, two buddies are never free. A block can have either a buddy used by the program or none.

The classic buddy system is the *binary buddy system* (Knowlton, 1965). The binary buddy system assumes that storage consists of  $2^m$  locations for some integer  $m$ , with addresses  $0, \dots, 2^m - 1$ , and that these locations can be organized into blocks whose lengths can only be powers of 2. There is also an array `avail[ ]` such that, for each  $i = 0, \dots, m$ , `avail[ i ]` is the head of a doubly linked list of blocks of the same size,  $2^i$ .

The name of this method is derived from the fact that each block of memory (except the entire memory) is coupled with a buddy *of the same size* that participates with the block in reserving and returning chunks of memory. The buddy of a block of length  $2^i$  is determined by complementing bit  $i + 1$  in the address of this block. This is strictly related to the lengths of blocks, which can only be powers of 2. In particular, all blocks of size  $2^i$  have 0s in the  $i$  rightmost positions and differ only in the remaining bits. For example, if memory has only eight locations, then the possible addresses of blocks of size one are {000, 001, 010, 011, 100, 101, 110, 111}, addresses of blocks of size two are {000, 010, 100, 110}, of size four {000, 100}, and of size eight {000}. Note that in the second set of addresses, the last bit is 0, and the addresses refer to blocks of size  $2^1$ . The addresses in the third set have two ending 0s, because the size of the blocks is  $2^2$ . Now, for the second set, there are two pairs of blocks and their buddies: {(000, 010), (100, 110)}; for the third set, there is only one pair: (000, 100). Hence, the difference between the address of a block of size  $2^i$  and the address of its buddy is only in bit  $i + 1$ .

If a request arrives to allocate a memory block of size  $s$ , then the buddy system returns a memory block whose size is greater than or equal to  $s$ . There are many candidates for such blocks, so the list of such blocks is checked in `avail[ ]` whose size  $k$  is the smallest among all  $k \geq s$ . This list of blocks can be found in location `avail[ k ]`. If the list is empty, then the next list of blocks is checked in position  $k + 1$ , then in position  $k + 2$ , and so on. The search continues until a nonempty list is found (or the end of `avail[ ]` is reached), and then a block is detached from it.

The algorithm for memory allocation in binary buddy systems is as follows:

```
size of memory =  $2^m$  for some  $m$ ;  
avail[ i ] = -1 for  $i = 0, \dots, m-1$ ;  
avail[ m ] = first address in memory;
```

```

reserve(reqSize)
    roundedSize = [lg(reqSize)];
    availSize = min(roundedSize, ..., m) for which avail[availSize] > -1;
    if no such availSize exists
        failure;
    block = avail[availSize];
    detach block from list avail[availSize];
    while (roundedSize < availSize) // while an available block
        availSize--; // is too large - split it;
        block = left half of block;
        insert buddy of block in list avail[availSize];
    return block;

```

Each free block of the buddy system should include four fields indicating its status, its size, and its two neighbors in the list. On the other hand, reserved blocks include only a status field and a size field. Figure 12.3a illustrates the structure of a free block in the buddy system. The block is marked as free with the status field set to 0. The size is specified as  $2^5$  locations. No predecessor is specified, so this block is pointed to by `avail[5]`. The size of its successor is also  $2^5$  locations. Figure 12.3b illustrates a reserved block whose status field is set to 1.

**FIGURE 12.3** Block structure in the binary buddy system.

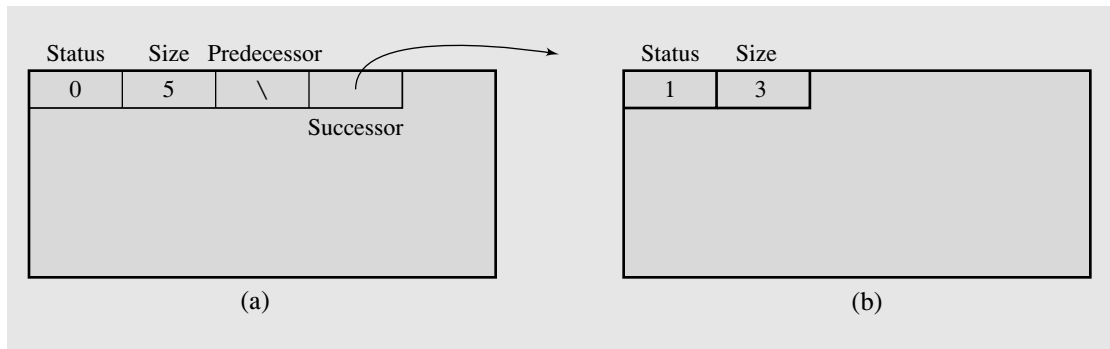
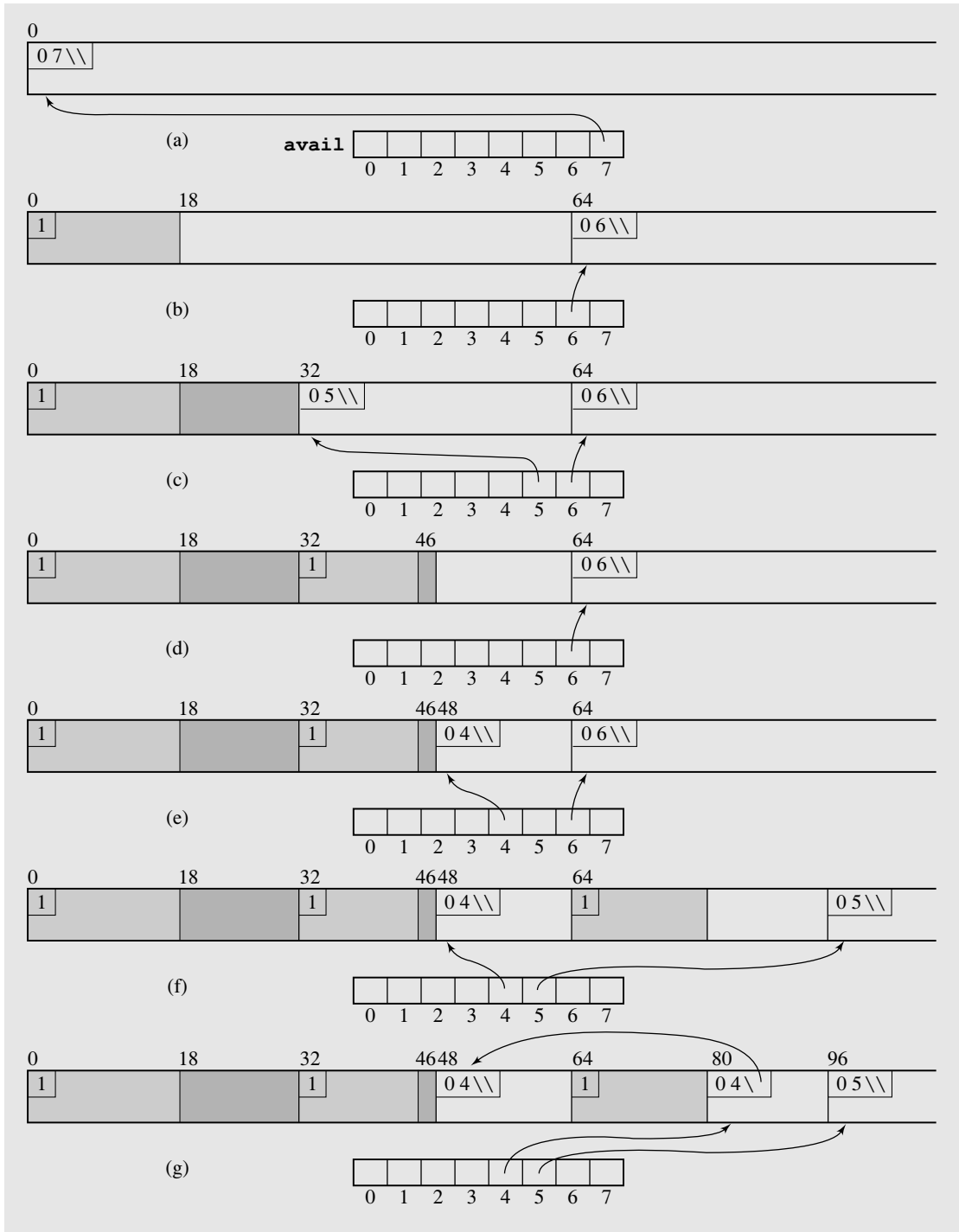


Figure 12.4 contains an example of reserving three blocks, assuming that the memory in use is of size  $2^7 = 128$  locations. First, the entire memory is free (Figure 12.4a). Then, 18 locations are requested, so  $\text{roundedSize} = \lceil \lg(18) \rceil = 5$ . But  $\text{availSize} = 7$ , so the memory is split into two buddies, each of size  $2^6$ . The second buddy is marked as available by setting the status field and including it in the list `avail[6]` (Figure 12.4b).  $\text{availSize}$  is still greater than  $\text{roundedSize}$ , so another iteration of the `while` loop of `reserve()` is executed. The first block is split into two and the second buddy is included in the list `avail[5]` (Figure 12.4c). The first buddy is marked as reserved and returned to the caller of `reserve()` for use. Note that only a portion of the returned block is really needed; however, the entire block is marked as reserved.

**FIGURE 12.4** Reserving three blocks of memory using the binary buddy system.



Next, a block of 14 locations is requested; now, `roundedSize = [lg(14)] = 4`, `availSize = 5`, and the block pointed to by `avail[5]` is claimed (Figure 12.4d). This block is too large because `roundedSize < availSize`, so the block is divided into two buddies. The first buddy is marked as reserved and returned, and the second is included in a list (Figure 12.4e). Finally, a block of 16 locations is requested. After two iterations of the `while` loop of `reserve()`, the configuration pictured in Figure 12.4g emerges; there are two available blocks of 16 locations and both are linked up in list `avail[4]`.

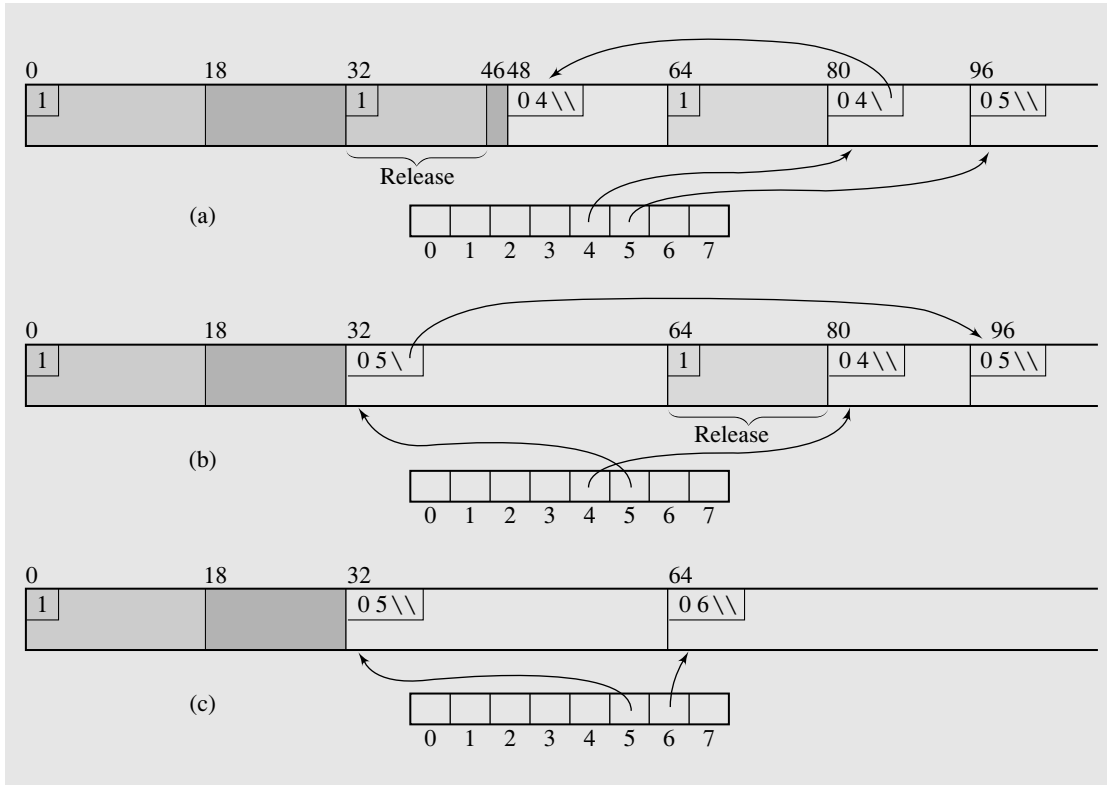
To be sure, blocks of memory are not only claimed, but also returned; hence, they have to be included in the pool of available blocks. Before they are included, the status of each block's buddy is checked. If the buddy is available, the block is combined with its buddy to create a block twice as large as before the combination. If the buddy of the new block is available, it is also combined with its buddy, resulting in a still larger block of memory. This process continues until the entire memory is combined into one block or a buddy is not available. This coalescing creates blocks of available memory as large as possible. The algorithm of including a block in the pool of available blocks is as follows:

```
include(block)
  blockSize = size(block);
  buddy = address(block) with bit blockSize+1 set to its complement;
  while status(buddy) is 0 // buddy has not
    and size(buddy) == blockSize // been claimed;
    and blockSize != lg(size of memory) // buddy exists;
    detach buddy from list avail[blockSize];
    block = block plus body; // coalesce block and its buddy;
    set status(block) to 0;
    blockSize++;
    buddy = address(now extended block) with bit blockSize+1 set to its complement;
  include block in list avail[blockSize];
```

Figure 12.5 illustrates this process. A block previously claimed is now released (Figure 12.5a), and because the buddy of this block is free, it is combined with the block, resulting in a double-sized block, which is included in the list `avail[5]` (Figure 12.5b). Releasing another block allows the memory manager to combine this block with its buddy and the resulting block with its buddy (Figure 12.5c). Note that the free portion of the leftmost block (marked with the darker screen) did not participate in this coalescing process and is still considered occupied. Also, the two rightmost blocks in Figure 12.5c, although adjacent, were not combined because they are not buddies. Buddies in the binary buddy method have to be of the same size.

The binary buddy system, although relatively efficient in terms of speed, may be inefficient in terms of space. Figure 12.4d shows that the two leftmost blocks amount to a size of 48 locations, but only 32 of them are in use, because the user really needs  $18 + 14$  locations. This means that one-third of these two blocks is wasted. This can get even worse if the number of locations requested is always slightly more than a power of 2. In this case, approximately 50 percent of memory is not in actual use. This is a problem with internal fragmentation that results from the need to round all requests to the nearest larger power of 2.

**FIGURE 12.5** (a) Returning a block to the pool of blocks, (b) resulting in coalescing one block with its buddy. (c) Returning another block leads to two coalescings.



Also, there may be a problem with external fragmentation; a request may be refused although the amount of available space is sufficient to meet it. For example, for the configuration of memory in Figure 12.4g, a request for 50 locations is refused because there is no block available with a size of 64 locations or more. A request for 33 locations is treated similarly and for the same reason, although there are 33 available consecutive locations. But one of these locations belongs to another block, which puts it out of reach.

These problems are brought about by the fact that the binary buddy system uses a simple division of blocks into two even parts, which results in the division of memory not sufficiently tuned to incoming requests. The sequence of block sizes possible in this system is 1, 2, 4, 8, 16, . . . ,  $2^m$ . An improvement of the binary buddy system can be obtained if this sequence is rendered by the recurrence equation

$$s_i = \begin{cases} 1 & \text{if } i = 0 \\ s_{i-1} + s_{i-1} & \text{otherwise} \end{cases}$$

which can be considered a particular case of a more general equation:

$$s_i = \begin{cases} c_1 & \text{if } i = 0, \\ \vdots & \vdots \\ c_k & \text{if } i = k - 1 \\ s_{i-1} + s_{i-2} & \text{otherwise} \end{cases}$$

If  $k = 1$ , then this equation renders the equation for the binary buddy system. If  $k = 2$ , then the obtained formula is a very familiar equation for a Fibonacci sequence:

$$s_i = \begin{cases} 1 & \text{if } i = 0, 1 \\ s_{i-1} + s_{i-2} & \text{otherwise} \end{cases}$$

This leads to the *Fibonacci buddy system* developed by Daniel S. Hirschberg. He chose 3 and 5 as the values for  $s_0$  and  $s_1$ . If  $k > 2$ , then we enter the realm of the *generalized Fibonacci systems* (Hinds, 1975).

The problem with the Fibonacci buddy system is that finding a buddy of a block is not always simple. In the binary buddy system, the information stored in the size field of the block is sufficient to compute the address of the buddy. If the size holds the number  $k$ , then the address of the buddy is found by complementing the bit  $k + 1$  in the address of the block. This works regardless of whether the block has a right buddy or a left buddy. The reason for this simplicity is that only powers of 2 for the sizes of all blocks are used, and each block and its buddy are of the same size.

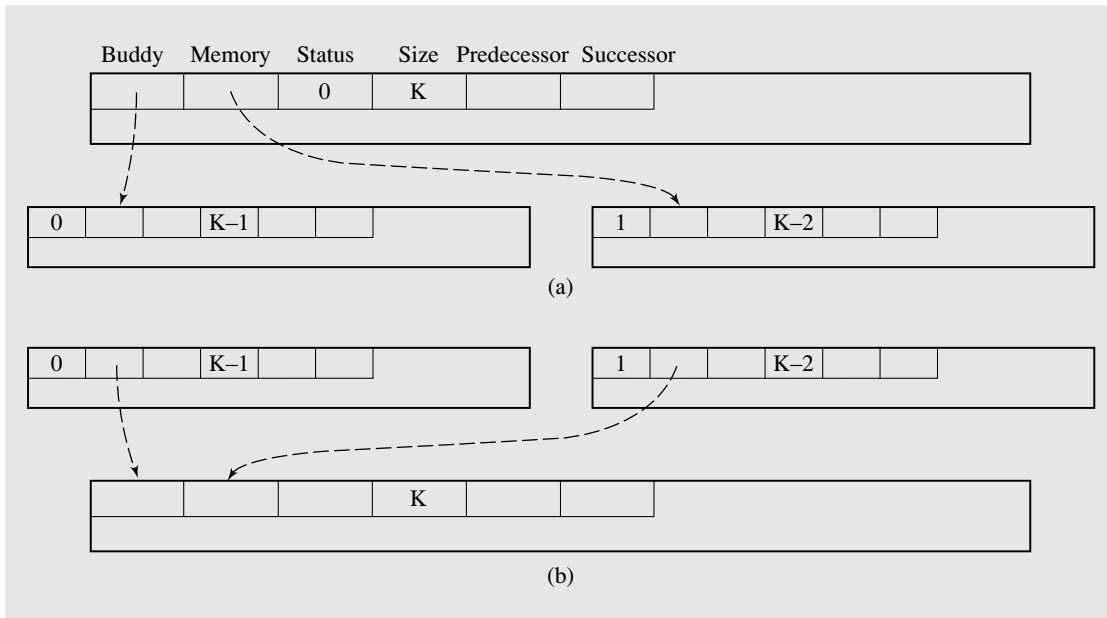
In the Fibonacci system, this approach is inapplicable, yet it is necessary to know whether a returned block has a right or a left buddy in order to combine the two. Not surprisingly, finding the buddy of a block may be rather demanding in terms of time or space. To this end, Hirschberg used a table that could have nearly 1,000 entries if buffers of up to 17,717 locations are allowed. His method can be simplified if a proper flag is included in each block, but a binary Left/Right flag may be insufficient. If block  $b_1$  marked as Left is coalesced with its buddy, block  $b_2$ , then the question is: How do you find the buddy of the resulting block,  $b_3$ ? An elegant solution uses two binary flags instead of one: a buddy-bit and a memory-bit (Cranston and Thomas, 1975). If a block  $b_1$  is split into blocks  $b_{left}$  and  $b_{right}$ , then  $\text{buddy-bit}(b_{left}) = 0$ ,  $\text{buddy-bit}(b_{right}) = 1$ ,  $\text{memory-bit}(b_{left}) = \text{buddy-bit}(b_1)$ , and finally,  $\text{memory-bit}(b_{right}) = \text{memory-bit}(b_1)$  (see Figure 12.6a). The last two assignments preserve some information about predecessors:  $\text{Memory-bit}(b_{left})$  indicates whether its parent is a left or right buddy, and  $\text{memory-bit}(b_{right})$  is a bit of information to indicate the same status for one of the predecessors of its parent. Note that the coalescing process is an exact reversal of splitting (see Figure 12.6b).

The algorithms for reserving blocks and for returning them are in many respects similar to the algorithms used for the binary buddy system. An algorithm for reserving blocks is as follows:

```
avail[i] = -1 for i = 0, ..., m-1;
avail[m] = first address in memory;

reserveFib(reqSize)
    availSize = the position of the first Fibonacci number greater than reqSize
                for which avail[availSize] > -1;
```

**FIGURE 12.6** (a) Splitting a block of size  $Fib(k)$  into two buddies using the buddy-bit and the memory-bit. (b) Coalescing two buddies utilizing information stored in buddy- and memory-bits.



```

if no such availSize exists
    failure;
block = avail[availSize];
detach block from list avail[availSize];
while Fib(availSize-1) > reqSize // while an available block is
                                // too large - split it; choose
    if reqSize ≤ Fib(availSize-2) // smaller of the buddies if it's
        insert block's larger part in avail[availSize-1]; // large enough;
        block = block's smaller part;
    else insert block's smaller part in avail[availSize-2];
        block = block's larger part;
    availSize = size(block);
    set flags(block);
    set flags(block's buddy);
return block;

```

Another extension of the binary buddy system is a *weighted buddy system* (Shen and Peterson, 1974). Its goal, as in the case of Fibonacci systems, is to decrease the amount of internal fragmentation by allowing more block sizes than in the binary system. Block sizes in the weighted buddy system in memory of  $2^m$  unary blocks are  $2^k$  for  $0 \leq k \leq m$ , and  $3 \cdot 2^k$ , for  $0 \leq k \leq m-2$ ; the sizes are 1, 2, 3, 4, 6, 8, 12, 16, 24, 32, . . . , which is nearly twice as many different sizes than in the binary method. If necessary,



blocks of size  $2^k$  are split into blocks  $3 \cdot 2^{k-2}$  and  $2^{k-2}$ , and the blocks of size  $3 \cdot 2^k$  are split into blocks  $2^{k+1}$  and  $2^k$ . Note that the buddy of a  $2^k$  block cannot be uniquely determined because it can have either a right buddy of size  $2^{k+1}$  or  $3 \cdot 2^k$  or it can have a left buddy of size  $2^{k-1}$ . To distinguish between these three cases, a 2-bit flag *type* is added to each block. However, simulations indicate that the weighted buddy system is three times slower and generates larger external fragmentation than the binary buddy system. As mentioned, the weighted buddy system requires two additional bits per block, and the algorithm is more complex than in the binary buddy system, because it requires considering more cases when coalescing blocks.

A buddy system that takes a middle course between the binary system and the weighted system is a *dual buddy system* (Page and Hagins, 1986). This method maintains two separate memory areas, one with block sizes  $1, 2, 4, 8, 16, \dots, 2^i, \dots$  and another with block sizes  $3, 6, 9, 18, 36, \dots, 3 \cdot 2^j, \dots$ . In this way, the binary buddy method is applied in two areas. Internal fragmentation of the dual method is more or less halfway between that of the binary and weighted methods. External fragmentation in the dual buddy system is almost the same as that of the binary buddy system.

To conclude this discussion, observe that internal fragmentation is often inversely proportional to external fragmentation because internal fragmentation is avoided if allocated blocks are as close in size to the requested blocks as possible. But this means that some small splinter blocks are generated that are of little use. These small blocks can be compacted together to form a large block with sequential-fit methods, but compaction does not square very well with the buddy system approach. In fact, the variant buddy system, which is an elaboration of the weighted buddy method, attempts to compact memory, but the complexity of the algorithm undermines its usefulness (Bromley, 1980).

## 12.3 GARBAGE COLLECTION

As mentioned at the beginning of this chapter, some languages have automatic storage reclamation in their environment so that no explicit return on unused memory cells must be done by any program. The program can allocate memory through the function `new`, but there is no need to return the allocated memory block to the operating system if the block is not needed any longer. The block is simply abandoned, and it will be reclaimed by a method called a *garbage collector* that is automatically invoked to collect unused memory cells when the program is idle or when memory resources are exhausted.

The garbage collector views the heap as a collection of memory cells, or nodes, each cell composed of several fields. Depending on the garbage collector, the fields can be different. For example, in LISP, a cell has two pointers, *head* and *tail* (or in LISP terminology, *car* and *cdr*), to other cells, except for atomic cells that have no pointers. The cells include headers with such elements as an atom/nonatom flag and a marked/ unmarked flag. Data that are included may be stored in yet another field of a cell or in the portion of atomic cells used for pointers in nonatomic cells. Moreover, if variable sized cells are used, the header includes the number of bytes in the data field. Using more than two pointer fields is also possible. References to all linked structures currently utilized by the program are stored in a *root set*, which contains all *root pointers*. The garbage collector's task is to determine those parts of memory that are accessible from any of these pointers and parts that are not currently in use and can be returned to the free memory pool.

Garbage collection methods usually include two phases, which may be implemented as distinct passes or can be integrated:

1. The *marking* phase—to identify all currently used cells.
2. The *reclamation* phase—when all unmarked cells are returned to the memory pool; this phase can also include heap compaction.

### 12.3.1 Mark-and-Sweep

A classical method of collecting garbage is the *mark-and-sweep* technique, which clearly distinguishes the two phases. First, memory cells currently in use are marked by traversing each linked structure, and then the memory is swept to glean unused (garbage) cells and put them together in a memory pool.

#### *Marking*

A simple marking procedure looks very much like preorder tree traversal. If a node is not marked, then it is marked, and if it is not an atomic node, marking continues for its *head* and for its *tail*:

```
marking (node)
  if node is not marked
    mark node;
  if node is not an atom
    marking(head(node));
    marking(tail(node));
```

This procedure is called for each element of the root set. The problem with this succinct and elegant algorithm is that it may cause the run-time stack to overflow, which is a very real prospect considering the fact that the list being marked can be very long. Therefore, an explicit stack can be used so that there is no need to store on the run-time stack the data necessary to properly resume execution after returning from recursive calls. Here is an example of an algorithm that uses an explicit stack:

```
markingWithStack (node)
  push(node);
  while stack is not empty
    node = pop();
    while node is an unmarked nonatom
      mark node;
      push(tail(node));
      node = head(node);
    if node is an unmarked atom
      mark node;
```

The problem of an overflow is not avoided altogether. If the stack is implemented as an array, the array may turn out to be too small. If it is implemented as a linked list, it may be impossible to use, because the stack requires memory resources that have just

been used up and in the restoration of which the stack was supposed to participate. There are two ways to avoid this predicament: by using a stack of limited size and invoking some operations in case of stack overflow or by trying not to use any stack at all.

A useful algorithm that requires no explicit stack was developed by Schorr and Waite. The basic idea is to, in a sense, incorporate the stack in the list being processed. This technique belongs in the same category as the stackless tree traversal techniques discussed in Section 6.4.3. In the Schorr and Waite marking method, some links are temporarily reversed when traversing the list to “remember” the path back, and their original setting is restored after marking all cells accessible from a position in which the reversal has been performed. When a marked node or an atom is encountered, the algorithm returns to the preceding node. However, it can return to a node through the *head* field or through the *tail* field. In the former case, the *tail* path has to be explored, and the algorithm has to use a marker to indicate whether both *head* and *tail* paths have been checked or only the *head* path has been checked. To that end, the algorithm uses one additional bit called a *tag* bit. If the *head* of a cell is accessed, then the tag bit remains zero so that, upon return to this cell, the path accessible from *tail* will be followed, in which case the tag bit is set to one and reset to zero upon return. The summary of the algorithms is as follows:

```
invertLink (p1, p2, p3)
    tmp = p3;
    p3 = p1;
    p1 = p2;
    p2 = tmp;

SWmarking (curr)
    prev = null;
    while (1)
        mark curr;
        if head(curr) is marked or atom
            if head(curr) is an unmarked atom
                mark head(curr);
            while tail(curr) is marked or atom
                if tail(curr) is an unmarked atom
                    mark tail(curr);
                while prev is not null and tag(prev) is 1 // go back
                    tag(prev) = 0;
                    invertLink(curr, prev, tail(prev));
                if prev is not null
                    invertLink(curr, prev, head(prev));
                else finished;
            tag(curr) = 1;
            invertLink(prev, curr, tail(curr));
        else invertLink(prev, curr, head(curr));
```

Figure 12.7 illustrates an example. Each part of this figure shows changes in the list after the indicated operations have been performed. Note that atom nodes do not require a tag bit. Figure 12.7a contains the list before marking. Each nonatomic node

**FIGURE 12.7** An example of execution of the Schorr and Waite algorithm for marking used memory cells.

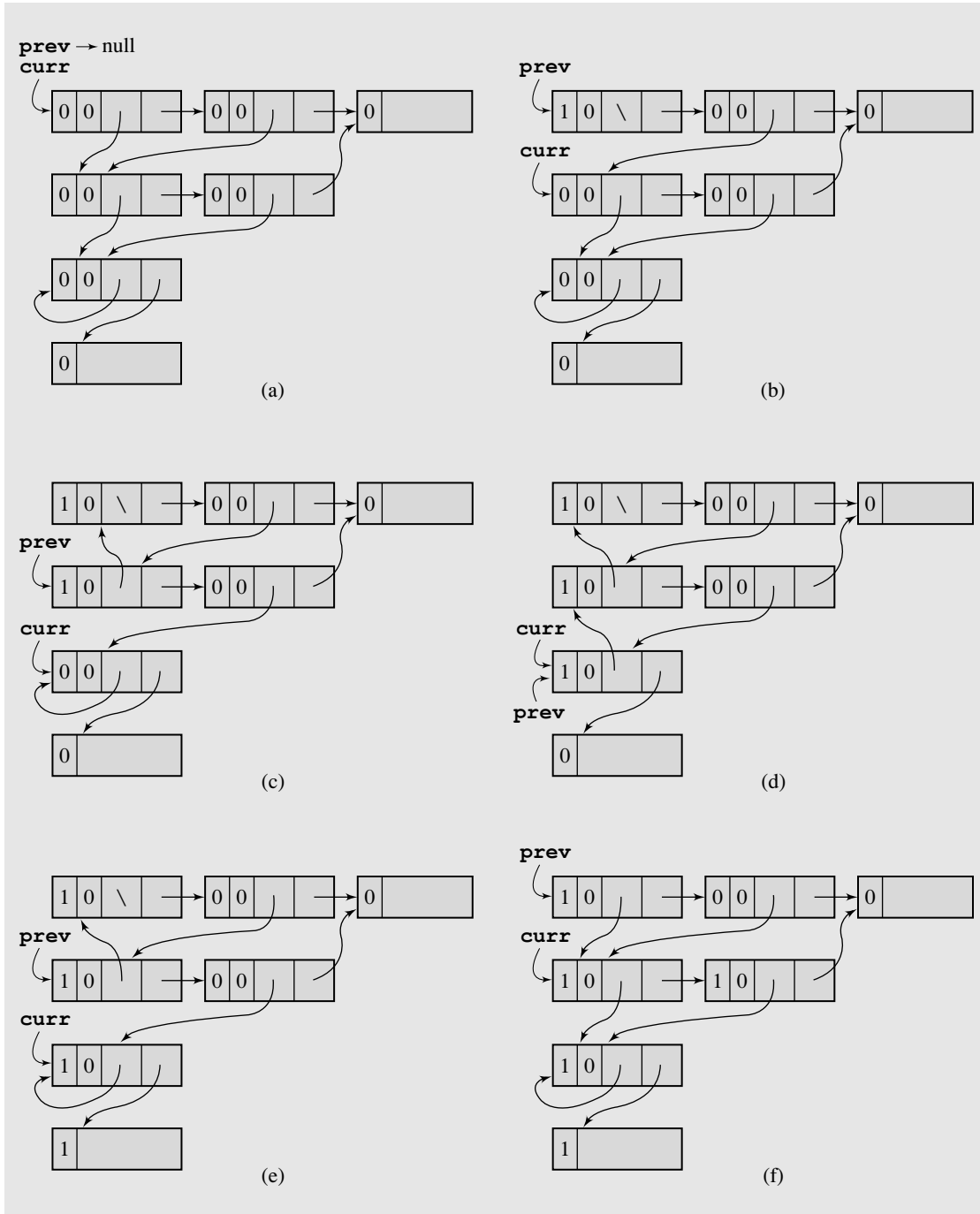
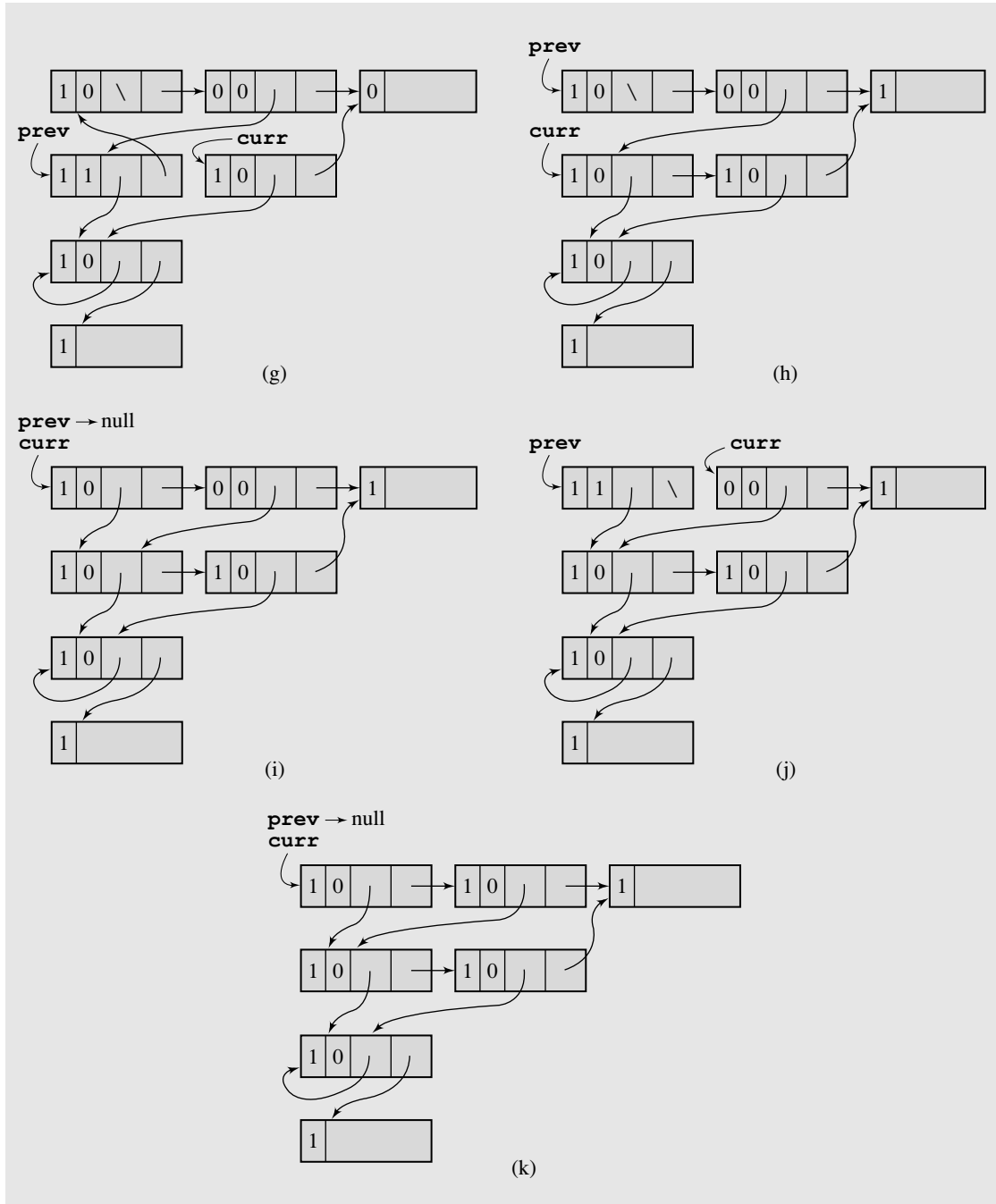


FIGURE 12.7 (continued)



has four parts: a marking bit, a tag bit, and *head* and *tail* fields. The marking and tag bits are initialized to 0. There is one more bit not shown in this figure, an atom/nonatom flag.

Here is a description of each iteration of the `while` loop and the figure number that contains the structure of the list after that iteration.

- Iteration 1:** Execute `invertLink(prev, curr, head(curr))` (Figure 12.7b).
- Iteration 2:** Execute another `invertLink(prev, curr, head(curr))` (Figure 12.7c).
- Iteration 3:** Execute still another `invertLink(prev, curr, head(curr))` (Figure 12.7d).
- Iteration 4:** Mark `tail(curr)` and execute `invertLink(curr, prev, head(prev))` (Figure 12.7e), execute another `invertLink(curr, prev, head(prev))` (Figure 12.7f), set `tag(curr)` to 1, and execute `invertLink(prev, curr, tail(curr))` (Figure 12.7g).
- Iteration 5:** Mark `tail(curr)` to 1, set `tag(prev)` to 0, and execute `invertLink(curr, prev, tail(prev))` (Figure 12.7h). Execute `invertLink(curr, prev, head(prev))` (Figure 12.7i), set `tag(curr)` to 1, and execute `invertLink(prev, curr, tail(curr))` (Figure 12.7j).
- Iteration 6:** Set `tag(prev)` to 0 and execute `invertLink(curr, prev, tail(prev))` (Figure 12.7k). The algorithm completes and `prev` becomes *null*.

Note that the algorithm has no problem with cycles in lists. `SWmarking()` is slower than `markingWithStack()`, because it requires two visits per cell, reference maintenance, and an additional bit. Hence, disposing of a stack does not seem to be the best solution. Other approaches attempt to combine a stack with some form of overflow handling. Schorr and Waite proposed such a solution by resorting to their link inversion technique if a fixed-length stack becomes full. Other techniques are more discriminating about what information should be stored on the stack. For example, `markingWithStack()` unnecessarily pushes onto the stack the nodes that have empty *tail* fields—nodes whose processing is finished after the *head* path is finished.

The method devised by Wegbreit requires no tag bit and uses a bit stack instead of a reference stack to store one bit for each node on the trace path whose *head* and *tail* fields both reference nonatoms. The trace path is the path from the current node to the root pointer. But as in the Schorr and Waite algorithm, link inversion is still in use. An improvement of this method is the fastmark algorithm (Kurokawa, 1981). As in Wegbreit's method, the fastmark algorithm retains information about nodes that refer to nonatoms on the stack. But the stack stores references to nodes, not bits, so link inversion is not necessary.

```
fastmark(node)
  if node is not an atom
    mark node;
  while (true)
    if both head(node) and tail(node) are marked or atoms
      if stack is empty
        finished;
      else node = pop();
    else if only tail(node) is not marked nor is it atom
      mark tail(node);
```

```

    node = tail(node);
else if only head(node) is not marked nor is it atom
    mark head(node);
    node = head(node);
else if both head(node) and tail(node) are not marked nor are they atoms
    mark both head(node) and tail(node);
    push(tail(node));
    node = head(node);

```

The reader is encouraged to apply this algorithm to the list in Figure 12.7a. However, the vexing problem of stack overflow is still not completely resolved. Although the fast-mark algorithm claims to require approximately 30 locations in most situations, some degenerate cases may occur that require thousands of locations in the stack. Therefore, fastmark has to be extended to be robust. The basic idea of the resulting *stacked-node-checking algorithm* is to delete from the stack nodes that are already marked or nodes whose *head* or *tail* path has already been traced. However, even this improved algorithm runs out of space occasionally, in which situation “it gives up and advises a fatal stack overflow error” (Kurokawa, 1981). Hence, the Schorr and Waite approach with its two techniques, stacking and list reversal, is more reliable although slower.

### Space Reclamation

After all the cells currently in use have been marked, the reclamation process returns all unmarked locations in memory to the heap pool by going sequentially through the heap, cell by cell, starting from the highest address and inserting all unmarked locations in the *avail-list*. Upon completion of this process, all locations on the *avail-list* are in ascending order. During this process, all mark bits are reset to 0 so that at the end the mark bits of all used and unused locations are 0. This simple algorithm is as follows:

```

sweep()
  for each location from the last to the first
    if mark(location) is 0
      insert location in front of availList;
    else set mark(location) to 0;

```

The `sweep()` algorithm makes a pass through the entire memory. If we add a pass required for marking and the subsequent maintenance of the `availList` containing locations sparsely scattered throughout the heap, this rather undesirable situation calls for improvement.

### Compaction

After the reclamation process is complete, the available locations are interspersed with the cells being used by the program. This requires *compaction*. If all available cells are in contiguous order, then there is no need to maintain the `availList`. Also, if garbage collection is used for reclaiming cells of variable cells, then having all available cells in sequence is highly desirable. Compaction is also necessary when garbage collection processes virtual memory. In this way, responses to memory requests can

be performed with a minimal number of accesses. Another situation in which compacting is beneficial is when the run-time stack and a heap are used at the same time. The heap and the stack are in opposite sides of memory and they grow toward one another. If occupied memory cells on the heap can be kept away from the stack, then the stack has more room for expansion.

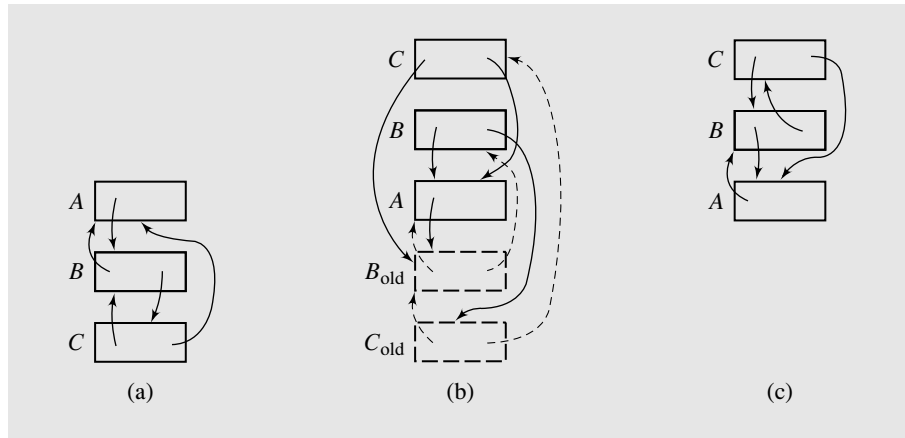
A simple *two-pointer algorithm* for heap compaction uses an approach similar to the one utilized in partitioning in quicksort: Two references scan the heap starting from opposite sides of memory. After the first reference finds an unmarked cell and the second finds a marked cell, the contents of the marked cell are moved to the unmarked cell and its new location is recorded in the old location. This process continues after the references cross. Then, the compacted part is scanned to readjust the *head* and *tail* references. If the references of the copied cells refer to locations beyond the compacted area, the old locations are accessed to retrieve the new address. Here is the algorithm:

```
compact()
  lo = the bottom of heap;
  hi = the top of heap;
  while lo < hi // scan the entire heap;
    while cell(lo) is marked
      lo++;
    while cell(hi) is not marked
      hi++;
    unmark cell(hi);
    move cell(hi) to position lo;
    tail(cell(hi--)) = lo++; // leave forwarding address;
  lo = the bottom of heap;
  while lo <= hi // scan only the compacted area;
    if cell(lo) is not atom and head(cell(lo)) > hi
      headcell(lo) = tail(head(cell(lo)));
    if cell(lo) is not atom and tail(cell(lo)) > hi
      tail(cell(lo)) = tail(tail(cell(lo)));
    lo++;
```

Figure 12.8 illustrates this process in the case of two available spots in front of cell *A* to which cells *B* and *C* can be moved. Figure 12.8a illustrates the situation in the heap before compaction. In Figure 12.8b, cells *B* and *C* have been moved into these spots with the *tail* fields of the old cells indicating the new positions. Figure 12.8c illustrates the compacted part of the heap after checking the *head* and *tail* fields of all cells and updating them in case they referred to positions beyond the compacted area.

This simple algorithm is inefficient in that it requires one pass through the heap to mark cells, one pass to move marked cells into contiguous locations, and one pass through the compacted area to update references; two and a half heap passes are required. One way to reduce the number of passes is to integrate marking and sweeping, which opens up a new category of methods.



**FIGURE 12.8** An example of heap compaction.

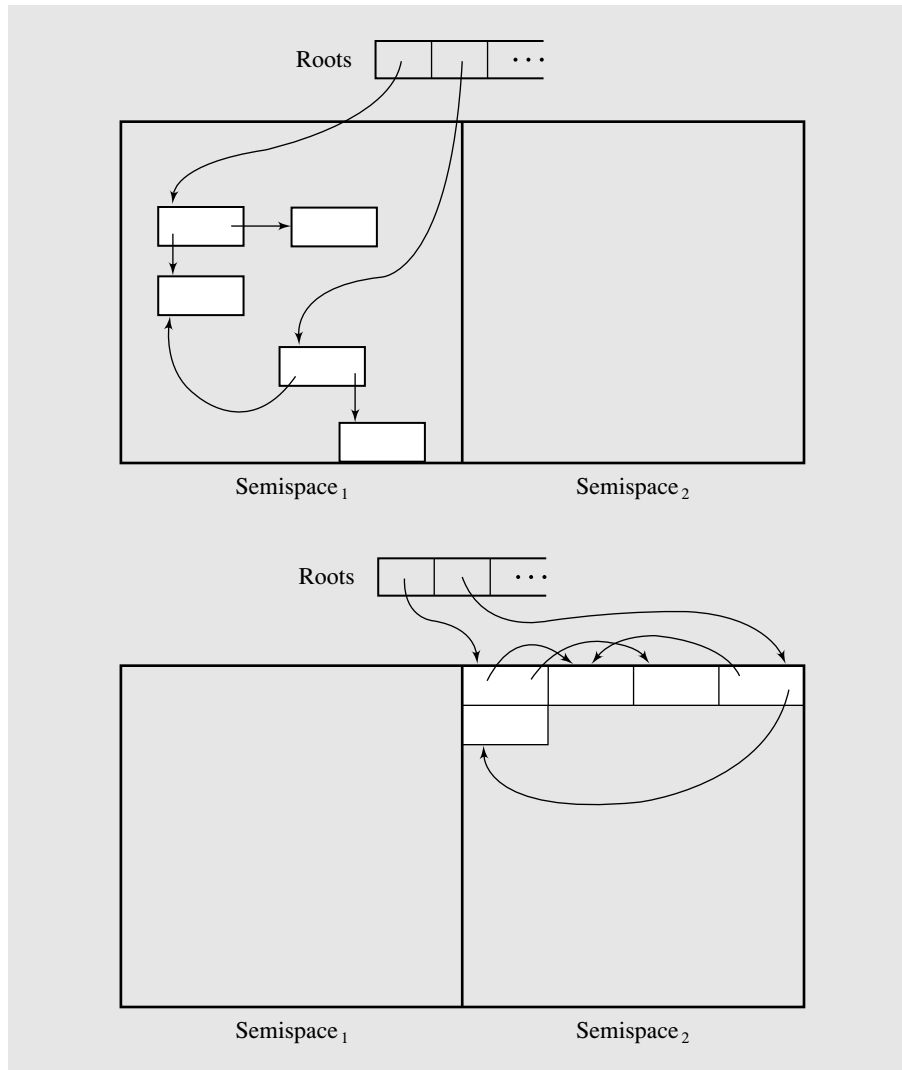
### 12.3.2 Copying Methods

Copying algorithms are cleaner than the previous methods in that they do not touch garbage. They process only the cells accessible from the root pointers and put them together; the unprocessed cells are available. An example of a copying method is the *stop-and-copy algorithm*, which divides the heap into two *semispaces*, one of which is only used for allocating memory (Fenichel and Yochelson, 1969). After the allocation reference reaches the end of the semispace, all the cells being used are copied to the second semispace, which becomes an active space, and the program resumes execution (see Figure 12.9).

Lists can be copied using breadth-first traversal (Cheney, 1970). If lists were just binary trees with no cross-references, the algorithm would be the same as the breadth-first tree traversal discussed in Section 6.4.1. However, lists can have cycles, and cells on one list can point to cells on another. In the latter case, this algorithm would produce multiple copies of the same cell. In the former case it would fall into an infinite loop. The problem can be easily solved, as in `compact()`, by retaining a forward address in the cell being copied. This allows the copying procedure to refer to a cell after it has already been copied. This algorithm requires no marking phase and no stack. The breadth-first traversal also allows it to combine two tasks: copying lists and updating references. The algorithm deals with garbage only indirectly because it does not really access unneeded cells. The more garbage that is in memory, the faster the algorithm.

Note that the cost of garbage collection decreases with the increase in the size of the heap (semispaces). Actually, not only does the number of collections drop with the increase of the heap, but the time per collection decreases, which is a more unexpected result. For example, a program run in 4MB memory requires 34 collections with an average of 6.8 seconds per collection. The same program run in 16MB memory requires only 3 collections with 2.7 seconds per collection—a very significant

**FIGURE 12.9** (a) A situation in the heap before copying the contents of cells in use from semispace<sub>1</sub> to semispace<sub>2</sub> and (b) the situation right after copying. All used cells are packed contiguously.



improvement. To be sure, if memory is really large (64MB in this example), no garbage collection is needed (Appel 1987). This also indicates that shifting the responsibility for free locations from the programmer (as in C++ or Pascal) to the garbage collector (as in Java) does not have to lead to slower programs. All this is true under the assumption that a large memory is available.

### 12.3.3 Incremental Garbage Collection

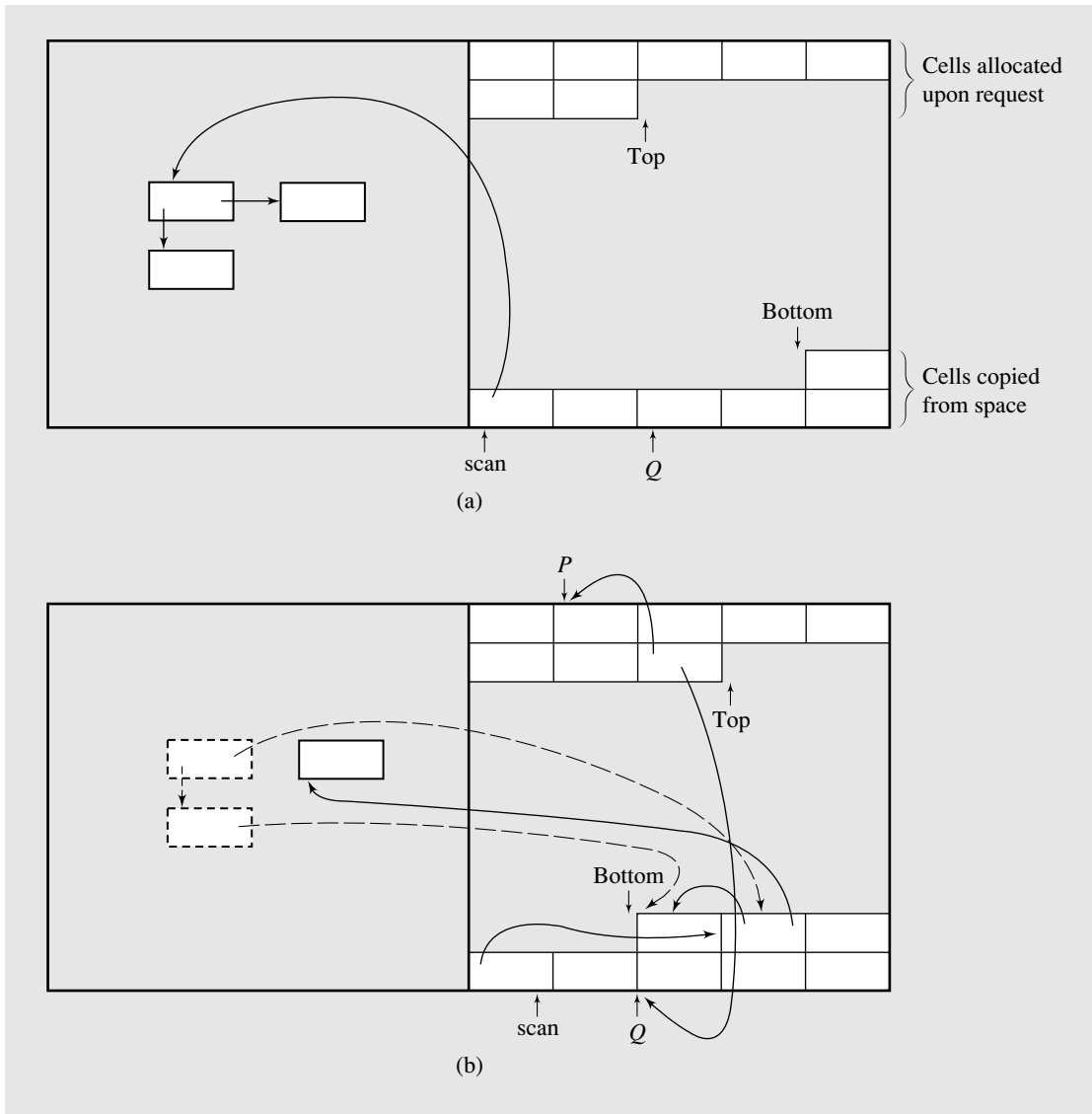
Garbage collectors are invoked automatically when the available memory resources become scanty. If this happens during the execution of a program, the garbage collector suspends program execution until the garbage collector finishes its task. Garbage collection may take several seconds, which may turn into minutes in time-sharing systems. This situation may not be acceptable in real-time systems in which the fast response of a program is vital. Therefore, it is often desirable to create *incremental garbage collectors* whose execution is interleaved with the execution of the program. Program execution is suspended only for a brief moment, allowing the collector to clean the heap to some extent, leaving some unprocessed portion of the heap to be cleaned later. But therein lies the problem. After the collector partially processes some lists, the program can change or mutate those lists. For this reason, a program used in connection with an incremental garbage collection is called a *mutator*. Such changes have to be taken into consideration after the collector resumes execution, possibly to reprocess some cells or entire lists. This additional burden indicates that incremental collectors require more effort than regular collectors. In fact, it has been shown that incremental collectors require twice the processing power of regular collectors (Wadler, 1976).

#### *Copying Methods in Incremental Garbage Collection*

An incremental algorithm based on the stop-and-copy technique has been devised by Henry Baker (1978). As in stop-and-copy, the Baker algorithm also uses two semispaces, called *fromspace* and *tospace*, which are both active to ensure proper cooperation between the mutator and the collector. The basic idea is to allocate cells in *tospace* starting from its top, and to always copy the same number,  $k$ , of cells from *fromspace* to *tospace* upon request. In this way, the collector can perform its task without incurring any undue interruption of the mutator's work. After all reachable cells have been copied to *tospace*, the roles of the semispaces are interchanged.

The collector maintains two references. The first reference is *scan*, which points to a cell whose *head* and *tail* lists should be copied to *tospace* if they still are in *fromspace*. Because these lists may be larger than  $k$ , they may not be processed at one time. Up to  $k$  cells accessible by breadth-first traversal are copied from *fromspace*, and the copies are put at the end of the queue. This queue is simply accessible by the second reference, *bottom*, which points to the beginning of the free space in *tospace*. The collector can process *tail* of the current cell during the same time slice, but it may wait until the next turn. Figure 12.10 contains an example. If a request comes to allocate a cell whose *head* points to  $P$  and *tail* to  $Q$  (as in LISP's  $cons(P, Q)$ ), with both  $P$  and  $Q$  residing in *tospace*, then a new cell is allocated in the upper part of *tospace* with both its reference fields properly initialized. Assuming that  $k = 2$ , two cells are copied from the *head* list of the cell pointed to by *scan*, and the *tail* is processed when the next request comes. As in stop-and-copy, Baker's algorithm retains a forwarding address in the original cell in *fromspace* to its copy in *tospace*, just in case later allocations refer to this original.

**FIGURE 12.10** A situation in memory (a) before and (b) after allocating a cell with *head* and *tail* references referring to cells *P* and *Q* in tospace according to the Baker algorithm.



Special care must be taken when the *head* and/or *tail* of a cell being allocated refer to a cell in fromspace that is either already copied or still in fromspace. Because the cells at the top of tospace are not processed by the collector, retaining a reference in any of them to fromspace cells leads to fatal consequences after fromspace becomes tospace because the latter cells are now considered available and filled with new con-

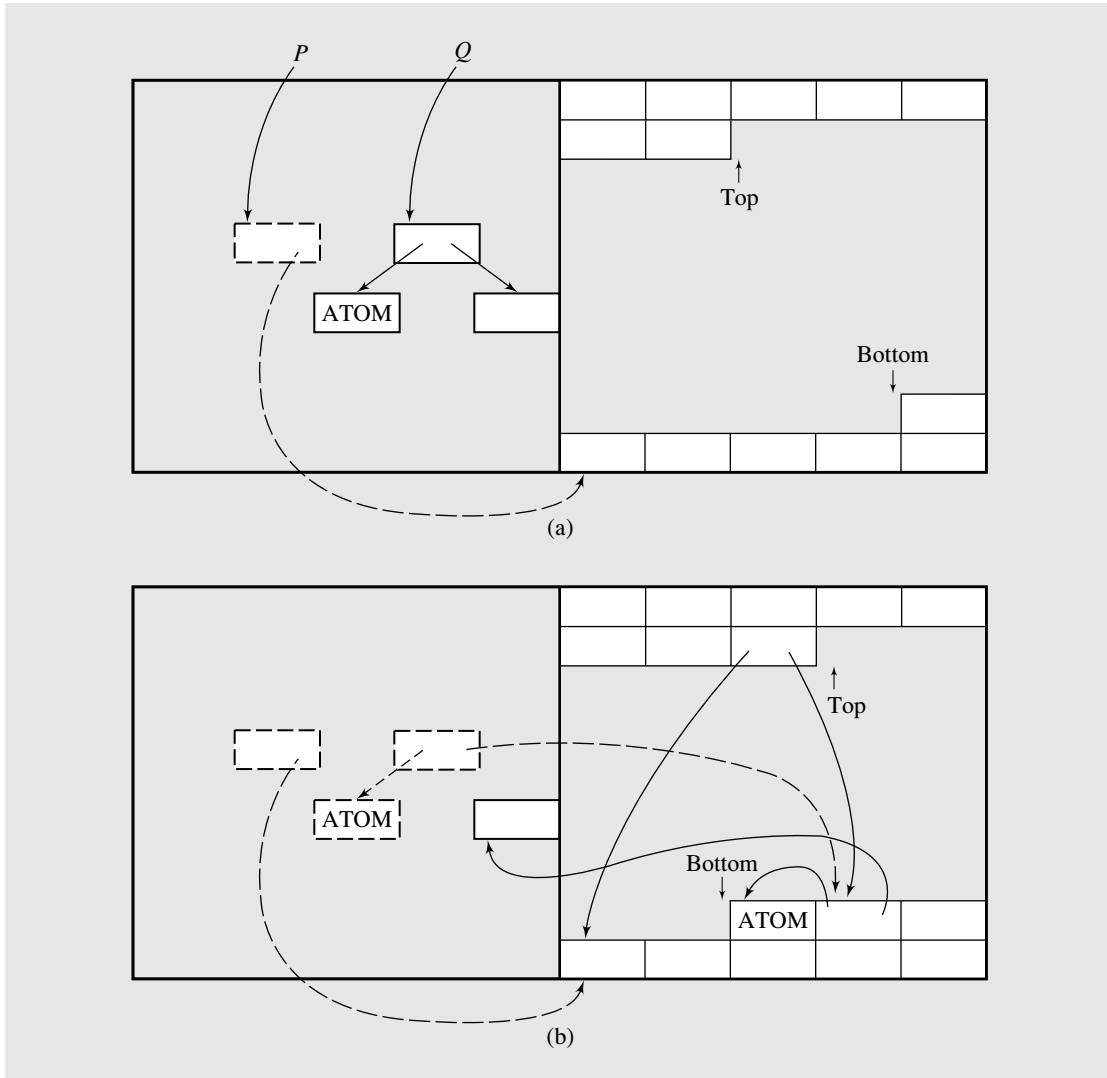
tents. The mutator could at one point use the reference to the original, and at a later point could use a copy, leading to inconsistencies. Hence, the mutator is preceded by a *read barrier*, which precludes utilizing references to cells in fromspace. In the case of a reference to fromspace, we have to check whether this cell has a forwarding address, an address in its *tail* to a location in tospace. If the answer is yes, the forwarding address is used in the allocation; otherwise, the cell referred to in the current allocation has to be copied *before* the actual allocation takes place. For example, if the *head* of a cell to be allocated is to point to  $P$ , a cell in fromspace that has already been copied, as illustrated in Figure 12.11a,  $P$ 's new address is stored in *head* (see Figure 12.11b). If the *tail* of the new cell is to point to  $Q$ , which is still untouched in fromspace,  $Q$  is copied to tospace (along with one descendant, because  $k = 2$ ) and only afterward is the *tail* of the new cell initialized to the copy of  $Q$ .

Baker's algorithm lends itself to various modifications and improvements. For example, to avoid constant condition tests when allocating new cells, an indirection field is included in every cell. If a cell is in tospace, the indirection field points to itself; otherwise, it points to its copy in tospace (Brooks, 1984). Tests are avoided, but indirection references have to be maintained for every cell instead. Another way to solve this problem is by utilizing hardware facilities, if available. For example, memory protection facilities can prevent the mutator's access to cells not processed by the collector: All pages of the heap with unprocessed cells are read-protected (Ellis, Li, and Appel, 1988). If the mutator attempts to access such a page, the access is trapped and an exception raised, forcing the collector to process this page so that the mutator can resume execution. But this method can undermine the incremental collection, because after the semispaces change roles, traps are invoked frequently, and each trap requires that an entire page of the heap be processed. Some additional provisions may be needed such as not requiring a scan of the entire page in case of a trap. On the other hand, if the heap is not accessed too frequently, this is not a problem.

An interesting modification to Baker's algorithm is a technique based on the observation that most allocated cells are needed for a very short time; only some of them are used for longer timespans. This leads to a *generational garbage collection* technique that divides all allocated cells into at least two generations and focuses its attention on the youngest generation, which generates most of the garbage. Such cells do not need to be copied, saving the garbage collector some work. Moreover, the constant checking and copying of long-lived cells is unnecessarily wasteful, so testing garbage production among such cells is performed only infrequently.

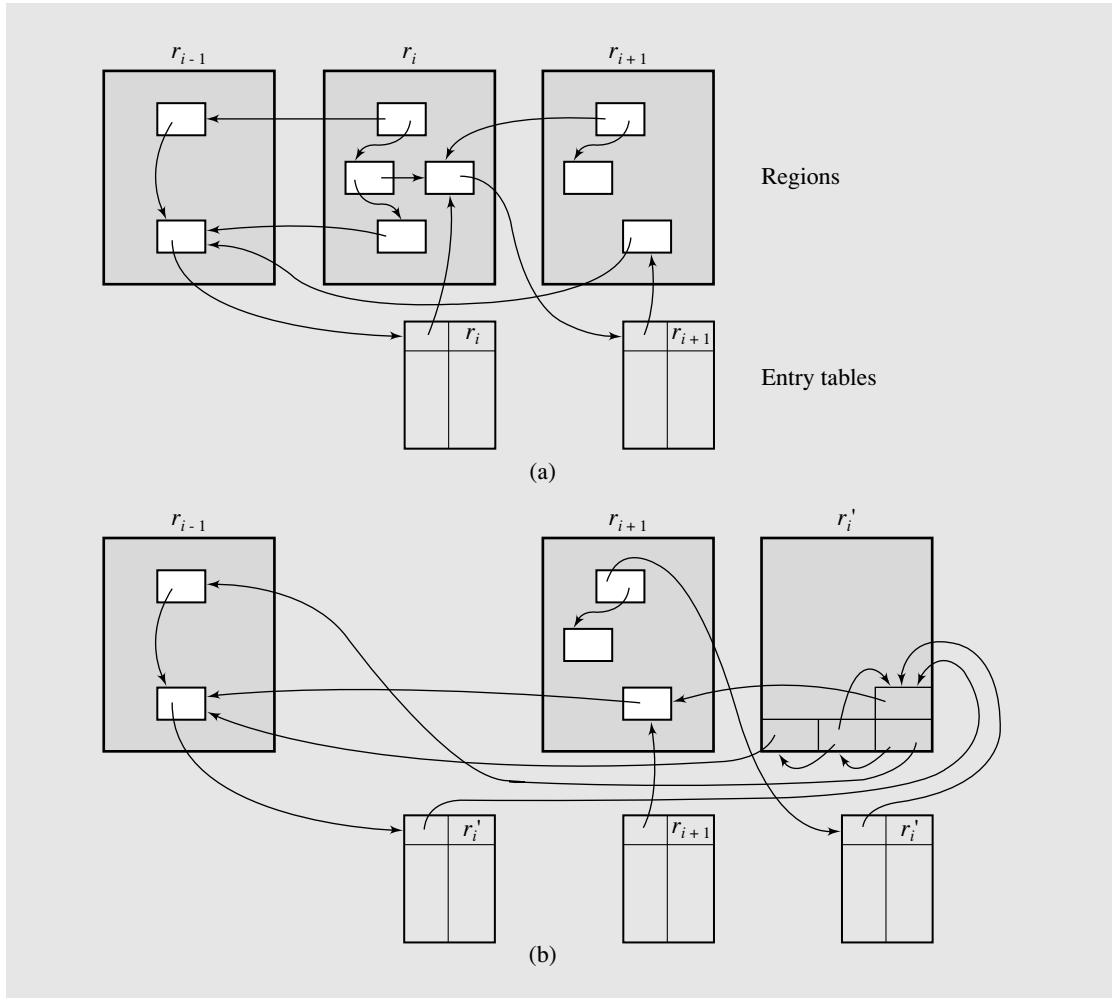
In a classic version of a generational garbage collector, the address space is divided into several regions,  $r_1 \dots, r_n$ , not just into tospace and fromspace; each of these regions holds cells of the same generation (Lieberman and Hewitt, 1983). Most references point to cells of an older generation. Some of them, however, can point forward in time (e.g., when LISP's *rplaca* is used). In this method, such forward references are made indirectly through an *entry table* associated with each region. A reference from a region  $r_i$  does not point to a cell  $c$  in a region  $r_{i+j}$  but to a cell  $c'$  in the entry table associated with  $r_{i+j}$ ;  $c'$  contains a reference to  $c$ . If a region  $r_i$  becomes full, all reachable cells are copied to another region  $r'_i$ , and all regions with generations younger than  $r_i$  are visited to update references referring to cells that just have been transferred to the new

**FIGURE 12.11** Changes performed by the Baker algorithm when addresses  $P$  and  $Q$  refer to cells in fromspace,  $P$  to an already copied cell,  $Q$  to a cell still in fromspace.



region. Regions with generations older than  $r_i$  do not have to be visited. Presumably only a few references in the entry table of  $r_i$  are updated (see Figure 12.12). The problem of cleaning the entry tables can be solved by storing in each table, along with each reference, a unique identifier for a region to which the reference refers. The identifier is updated along with the reference. Some references may be abandoned, as the reference in the entry table for region  $r_{i+1}$  in Figure 12.12b, and they are ready to be cleaned up after the region itself is abandoned.

**FIGURE 12.12** A situation in three regions (a) before and (b) after copying reachable cells from region  $r_i$  to region  $r'_i$  in the Lieberman-Hewitt technique of generational garbage collection.



### Noncopying Methods

In incremental methods based on copying, the problem is not so much with the content of the original cells and its copy, but with their positions or addresses in memory, which by necessity have to be different. The mutator must not treat these addresses on a par; otherwise, the program crashes. Therefore, some mechanisms are needed to maintain the integrity of addressing, and the read barrier serves this purpose. But we may need to avoid copying altogether; after all, the first garbage collection method, mark-and-sweep, did not use copies. However, because of the exhaustive and uninterrupted passes, the mark-and-sweep method was too costly, and in real-time systems,

it is simply unacceptable. Yet, the simplicity of this method is very appealing, and an attempt was made by Taiichi Yuasa to adapt it to real-time constraints, with satisfactory results.

Yuasa's algorithm also has two phases; one for marking reachable (used) cells and one for sweeping the heap by including in *avail-list* all unused (unmarked) cells. The marking phase is similar to that used in the mark-and-sweep method except that it is incremental; each time the marking procedure is invoked, it marks only  $k_1$  cells for some small constant  $k_1$ . After  $k_1$  cells have been marked, the mutator resumes execution. The constant  $k_2$  is used during the sweeping phase to decide how many cells have to be processed before execution is turned over to the mutator. The garbage collector remembers whether it is in the middle of marking or sweeping. The procedure for marking or sweeping is always invoked after one cell is requested from the heap by a procedure that creates one new root pointer and initializes its *head* and *tail* fields, as in the following pseudocode:

```
createRootPtr(p, q, r) // Lisp's cons
  if collector is in the marking phase
    mark up to  $k_1$  cells;
  else if collector is in the sweeping phase
    sweep up to  $k_2$  cells;
  else if the number of cells on availList is low
    push all root pointers onto collector's stack st;
  p = first cell on availList;
  head(p) = q;
  tail(p) = r;
  mark p if it is in the unswept portion of heap;
```

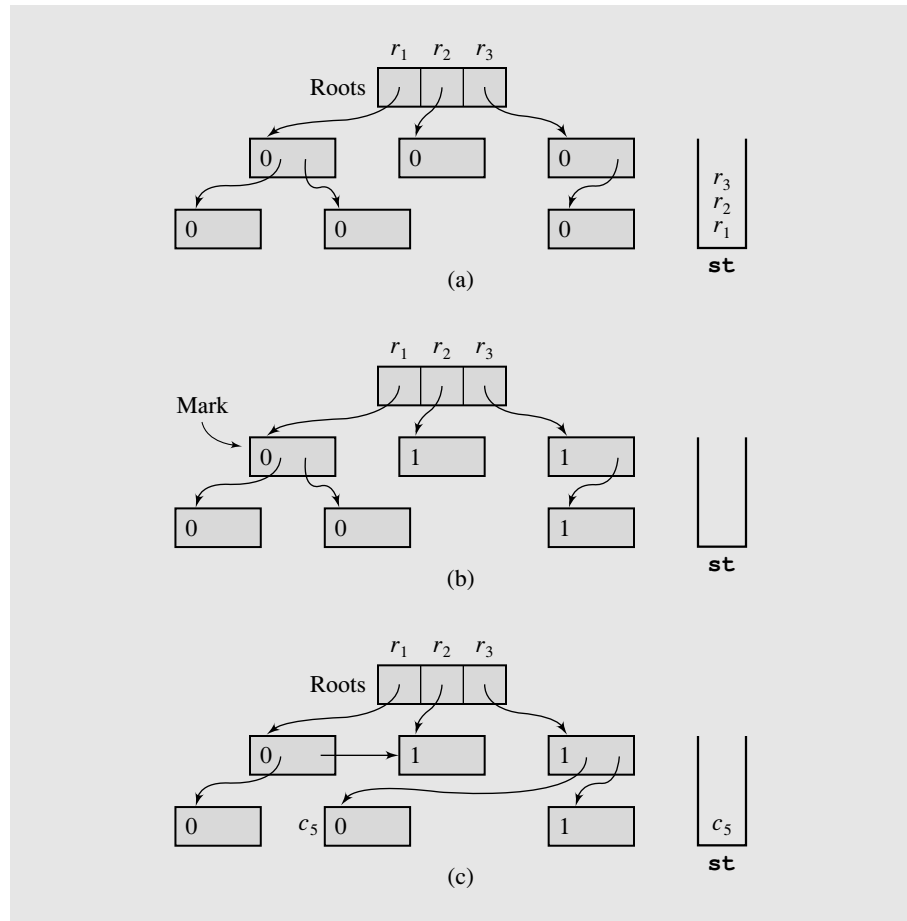
Remember that the mutator can scramble some graphs accessible from root pointers, which is particularly important if it happens during the marking phase, because it may cause certain cells to remain unmarked even though they are accessible. Figure 12.13 contains an example. After all of the roots have been pushed onto stack *st* (Figure 12.13a), and roots  $r_3$  and  $r_2$  have been processed and root  $r_1$  is being processed (Figure 12.13b), the mutator executes two assignments: *head*( $r_3$ ) is changed to *tail*( $r_1$ ), and *tail*( $r_1$ ) is assigned  $r_2$  (Figure 12.13c). If the marking process is now restarted, it has no chance to mark *head*( $r_3$ ) =  $c_5$ , because the entire graph  $r_3$  is assumed to have been processed. This leads to including the cell *head*( $r_3$ ) in the *avail-list* during the sweeping phase. To prevent that, the method that updates either *head* or *tail* of any cell pushes the old value of the field being updated onto the stack used by the garbage collector. For example,

```
updateTail(p, q) // Lisp's rplacd
  if collector is in the marking phase
    mark tail(p);
    st.push(tail(p));
  tail(p) = q;
```

In the marking phase, the stack *st* is popped up  $k_1$  times, and for each reference *p* popped off, its *head* and *tail* are marked.



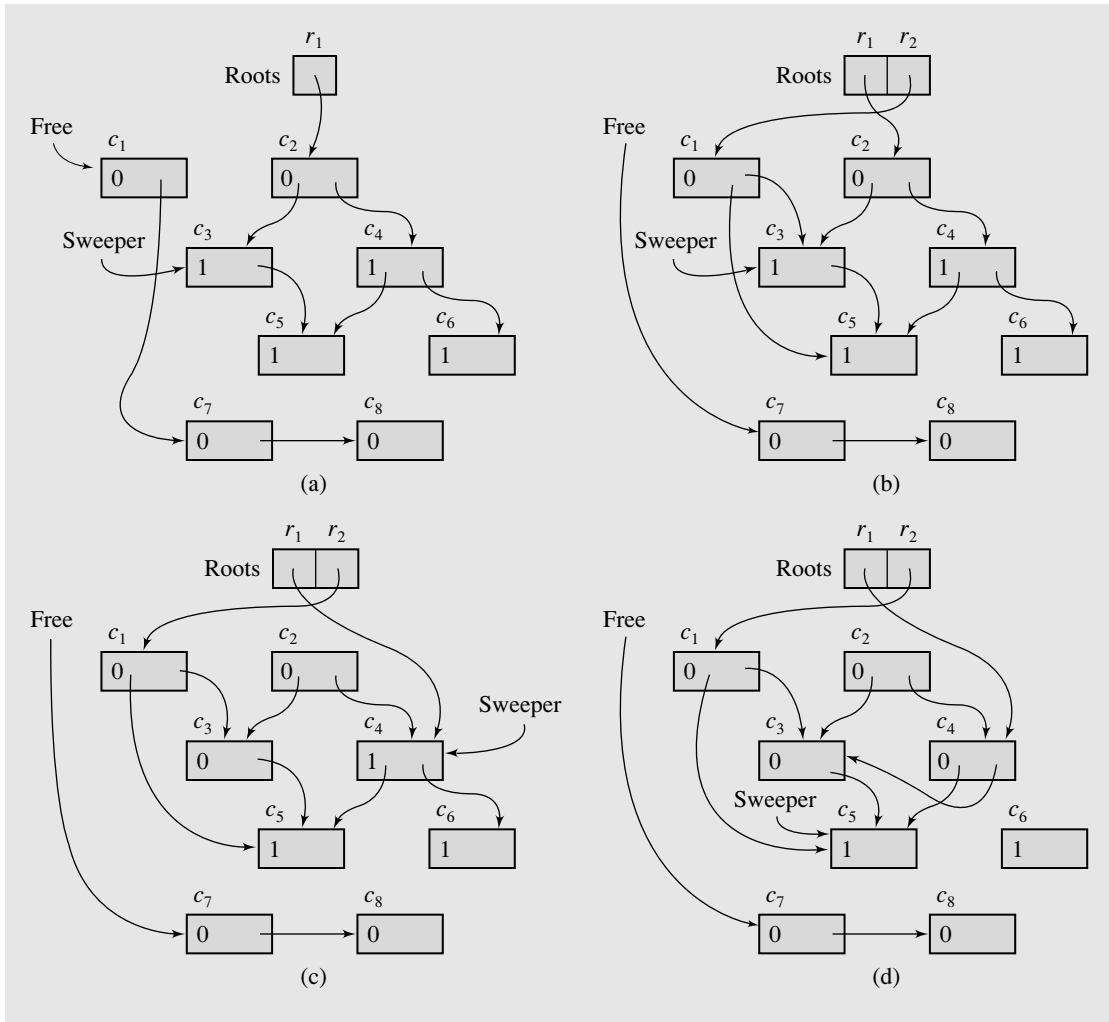
**FIGURE 12.13** An inconsistency that results if, in Yuasa's noncopying incremental garbage collector, a stack is not used to record cells possibly unprocessed during the marking phase.



The sweeping phase incrementally goes through the heap, includes in *avail-list* all unmarked cells, and unmarks all marked cells. For the sake of consistency, if a new cell is allocated, it remains unmarked if a certain part of the heap has been already swept. Otherwise, the next round of marking could lead to distorted results. Figure 12.14 illustrates an example. The reference *sweeper* has already reached cell  $c_3$ , and now the mutator requests a new cell by executing `createRootPtr( $r_2$ ,  $c_5$ ,  $c_3$ )`, whereby the first cell is detached from *avail-list* and made a new root (Figure 12.14b). But the newly allocated cell is not marked because it precedes *sweeper* in the heap.

If some cell is released in the swept area, it becomes garbage, but it is not swept up until sweeping restarts from the beginning of memory. For example, after assigning `tail( $r_1$ )` to  $r_1$ , cell  $c_2$  becomes unreachable, and yet it is not reclaimed now by adding it

**FIGURE 12.14** Memory changes during the sweeping phase using Yuasa's method.



to *avail-list* (Figure 12.14c). The same thing happens to cells having higher addresses than the current value of *sweeper*, as is the case with cell  $c_6$  after assigning  $tail(r_2)$  to  $tail(r_1)$  (Figure 12.14d). This is called *floating garbage*, and is collected in the next cycle.

## 12.4 CONCLUDING REMARKS

When assessing the efficiency of memory management algorithms, and especially garbage collectors, we have to be careful to avoid Paul Wilson's castigation that standard textbooks overstress the asymptotic complexity of algorithms missing the key point: "the constant factors associated with various costs" (Wilson, 1992). This is especially apparent in the case of nonincremental algorithms whose cost is usually proportional either to the size  $n$  of the heap (mark-and-sweep) or to the number  $m$  of reachable cells (stop-and-copy). This is an immediate indication of the superiority of the latter techniques, especially when the number of surviving cells is small compared to the heap size. However, when we take into consideration that the cost of sweeping is minuscule compared to the cost of copying, the difference in efficiency is not so obvious. In fact, as has been shown, real-time performances of the mark-and-sweep and stop-and-copy techniques are very similar (Zorn, 1990).

This example indicates that there are two main sources affecting the efficiency of algorithms: the behavior of the program and the characteristics of the underlying hardware. If a program allocates memory for a long time, then  $m$  approaches  $n$ ; scanning only reachable cells is close to scanning the entire heap (or its region). This is especially important for generational garbage collectors, whose efficiency relies on the assumption that most allocated cells are used for a very brief interval. On the other hand, if sweeping a cell is not much faster than copying it, then copying techniques have an edge.

Asymptotic complexity is too imprecise, and the published research on memory management indicates little preoccupation with computing this characteristic of algorithms. "The constant factors associated with various costs" are much more relevant. Also, fine-grained measures of efficiency are proposed, but not all of them are easy to measure, such as the amount of work per memory cell reclaimed, the rate of object creation, the average lifetime of objects, or the density of accessible objects (Lieberman and Hewitt, 1983).

Memory management algorithms are usually closely tied to the hardware, which may determine which algorithm is chosen. For example, garbage collection can be substantially sped up if some dedicated hardware is used. In LISP machines, the read barrier is implemented in hardware and microcode, which points to those incremental garbage collectors that rely on this barrier. Without hardware support, processing time in such collectors takes approximately 50 percent of program run time. If this hardware support is lacking, noncopying algorithms are a better choice. In real-time systems, where the responsiveness of the computer is the issue, additional overhead of the garbage collector is added. It may be less noticeable than in the case of nonincremental collectors, because at no time does a program have to wait in a visible way for the collector to finish its task. However, the tuning of incremental methods should be proportional to real-time constraints.

## 12.5

## CASE STUDY: AN IN-PLACE GARBAGE COLLECTOR

Copying algorithms for garbage collectors are efficient in that they do not require processing unused cells. Cells that are not processed are considered garbage at the end of collection. However, these algorithms are inefficient in copying reachable cells from one semispace to another. An in-place garbage collector attempts to retain the advantages of copying algorithms without producing copies of the reachable cells (Baker, 1992).

The in-place algorithm constantly maintains two doubly linked lists: `freeCells` and `nonFreeCells`. The list `freeCells` initially contains all cells of `heap[ ]`, and a cell is moved from `freeCells` to the other list if a request comes to construct a list or construct a new atom. After `freeCells` becomes empty, the method `collect()` is invoked. This method first transfers all root pointers from `nonFreeCells` to an intermediate list `markDescendants` and sets their `marked` field to true. Then, `collect()` detaches from `markDescendants` cell by cell to transfer each cell to another temporary list, `markedCells`. For each nonatom cell, `collect()` attaches to `markDescendants` unmarked head and tail references to be processed later. In the case study, they are attached to the beginning of `markDescendants`, thereby leading to depth-first traversal of list structures. For breadth-first traversal (as in Cheney's algorithm), they have to be attached to the end of `markDescendants`, which requires another reference to the end of the list. Note that, although a cell is transferred to `markedCells`, it is also marked to prevent infinite loops in case of cyclic structures and redundant processing in case of interconnected noncycling structures.

After the list `markDescendants` becomes empty, all reachable cells of `heap[ ]` have been processed and `collect()` is almost done. Before returning from `collect()`, all cells left in `nonFreeCells` become members of `freeCells`, and all marked cells are put on `nonFreeCells` after setting their `marked` fields to false. The user `program()` can now resume.

To be sure, the garbage collector is part of the program's environment and is executed in the background almost unbeknownst to the user. To exemplify the workings of a garbage collector, some elements of the program background are simulated in the case study, in particular the heap and the symbol table.

The heap is implemented as an array of objects with two flag fields, `atom/nonatom` and `marked/nonmarked`, and two reference fields, which are really integer fields indicating positions in `heap[ ]` of the previous and next cells (if any).

In accordance with this implementation, both permanent lists, `freeCells` and `nonFreeCells`, and both temporary lists, `markDescendants` and `markedCells`, are simply integers indicating the index in `heap[ ]` of the first cell on a given list (if any).

The symbol table is implemented as an integer array `roots[ ]` of root pointers. No explicit variable names are used, only indexes to `heap[ ]` cells. For example, if `roots` is `[3 2 4 0]`, then only four variables are currently in use by `program()`, `roots[0]` through `roots[3]`, and these variables are pointing to cells 3, 2, 4, and 0

in `heap[ ]`. The numbers 0–3 can be seen as subscripts to more palpable variable names, such as `var0`, `var1`, `var2` and `var3`.

The user `program()` is just a coarse simulator that does nothing but require allocations and reallocations on `heap[ ]`. These requirements are generated randomly and classified by the type of requirement: 20 percent are atom (re)allocations, 20 percent are list (re)allocations, 20 percent are head updates, 20 percent are tail updates, and the remaining 20 percent are deallocations. Deallocations are simulated by the method `deallocate()`, which decides whether an existing root variable should be assigned `empty` (which represents the null reference) or a local block is exited upon which all local variables are removed, which in turn means that memory assigned to them is free. The percentages can be assigned differently, and the distribution of assignments can be tuned to the number of assignments already made. This is just a matter of introducing changes in `program()`. Also, the size of `heap[ ]` and the size of `roots[ ]` can be modified.

The user `program()` randomly generates a number `rn` between 0 and 99 to indicate the operation to be performed. Then, variables are randomly chosen from `roots[ ]`. For example, if `rn` is 11, `roots[ ]` is [3 2 4 0], and `p` is 2, then the cell `roots[p] = 4` of `heap[ ]` indicated by variable 2 becomes an atom by storing the value of `val` in its `value` field and the `atom` field is set to true. If `p` is 4, this indicates that a new variable (variable 4, or `var4`) has to be created in position 4 of `roots[ ]`, and position `roots[4]` is assigned the first value from `freeCells`.

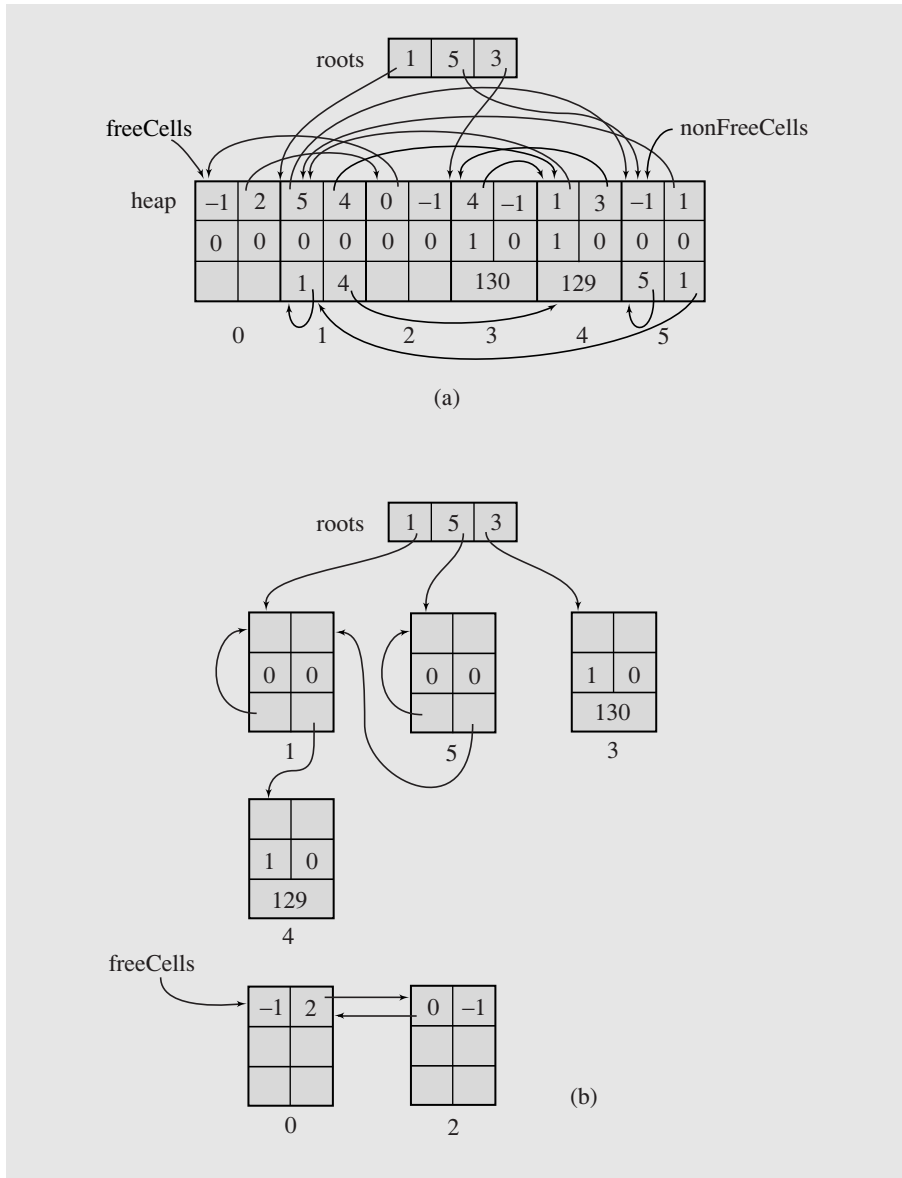
To see that this program does something, a simple `printList()` method is supplied, which prints elements on a given list, and a `printHeap()` method outputs the contents of `heap[ ]` and of `roots[ ]`. Here is an example of an output generated by `printHeap()` and by `printList()` called twice from `printHeap()` for a heap of six cells:

```
roots: 1 5 3
(0: -1 2 false false 0 0) (1: 5 4 false false 1 4)
(2: 0 -1 false false 2 2) (3: 4 -1 true false 130)
(4: 1 3 true false 129) (5: -1 1 false false 5 1)
freeCells: (0 0 0)(2 2 2)
nonFreeCells: (5 5 1)(1 1 4)(4 129)(3 130)
```

This output represents the situation illustrated in Figure 12.15. Figure 12.15a shows the contents of a heap with links `prev` and `next` used by lists `freeCells` and `nonFreeCells` and `info` field. For nonatom cells, this field references an object with two fields, `head` and `tail`; for atom cells, `info` field references an object that stores some value. Because of the number of crisscrossing links, the same situation is presented in Figure 12.15b, where the cells are organized by their connections rather than the positions in `heap`.

Figure 12.16 contains the listing of the program.

**FIGURE 12.15** An example of a situation on the heap.



**FIGURE 12.16** Implementation of an in-place garbage collector.

```

//***** Heap.java *****
import java.util.Random;

class Value {
    public int value;
    public Value(int v) {
        value = v;
    }
}

class Links {
    public int head = -1, tail = -1;
    public Links(int h, int t) {
        head = h; tail = t;
    }
}

class Cell {
    public boolean atom;
    public boolean marked = false;
    public int prev = -1, next = -1;
    public Object info = null; // either Value or Links;
}

public class Heap {
    private final int maxHeap = 6, maxRoot = 50, empty = -1;
    private int rootCnt = 0;
    private boolean OK = true;
    private Cell[] heap = new Cell[maxHeap];
    private int[] roots = new int[maxRoot];
    private int freeCells = empty, nonFreeCells = empty;
    private Random rd = new Random(10);
    public Heap() {
        for (int i = maxHeap-1; i >= 0; i--) {
            heap[i] = new Cell();
            freeCells = insert(i, freeCells);
        }
        for (int i = maxRoot-1; i >= 0; i--)
            roots[i] = empty;
    }
    public int rootCnt(){
        return rootCnt;
    }
}

```

*Continues*

**FIGURE 12.16** *(continued)*

```

public void updateHead(int p, int q) {          // Lisp's rplaca;
    if (roots[p] != empty && !heap[roots[p]].atom)
        ((Links)heap[roots[p]].info).head = roots[q];
}
public void updateTail(int p, int q) {         // Lisp's rplacd;
    if (roots[p] != empty && !heap[roots[p]].atom)
        ((Links)heap[roots[p]].info).tail = roots[q];
}
private int detach(int cell, int list) {
    if (heap[cell].next != empty)
        heap[heap[cell].next].prev = heap[cell].prev;
    if (heap[cell].prev != empty)
        heap[heap[cell].prev].next = heap[cell].next;
    if (cell == list)                // head of the list;
        return heap[cell].next;
    else return list;
}
private int insert(int cell, int list) {
    heap[cell].prev = empty;
    if (cell == list) // don't create a circular list;
        heap[cell].next = empty;
    else heap[cell].next = list;
    if (list != empty)
        heap[list].prev = cell;
    return cell;
}
private void collect() {
    int p, markDescendants = empty, markedCells = empty;
    for (p = 0; p < rootCnt; p++) {
        if (roots[p] != empty) {
            nonFreeCells = detach(roots[p], nonFreeCells);
            markDescendants = insert(roots[p], markDescendants);
            heap[roots[p]].marked = true;
        }
    }
    printList(markDescendants, "markDescendants C1 "+p);
    for (p = markDescendants; p != empty; p = markDescendants) {
        markDescendants = detach(p, markDescendants);
        markedCells = insert(p, markedCells);
        if (!heap[p].atom) {
            if (!heap[((Links)heap[p].info).head].marked) {

```



**FIGURE 12.16** (continued)

```

        nonFreeCells    = detach(((Links)heap[p].info).head,
                                nonFreeCells);
        markDescendants = insert(((Links)heap[p].info).head,
                                markDescendants);
        heap[(((Links)heap[p].info).head).marked] = true;
    }
    if (!heap[(((Links)heap[p].info).tail).marked]) {
        nonFreeCells    = detach(((Links)heap[p].info).tail,
                                nonFreeCells);
        markDescendants = insert(((Links)heap[p].info).tail,
                                markDescendants);
        heap[(((Links)heap[p].info).tail).marked] = true;
    }
}
}
printList(markedCells, "MarkedCells");
for (p = markedCells; p != empty; p = heap[p].next)
    heap[p].marked = false;
freeCells    = nonFreeCells;
nonFreeCells = markedCells;
}
private boolean allocateAux(int p) {
    if (p == maxRoot) {
        System.out.println("No room for new roots");
        return !OK;
    }
    if (freeCells == empty)
        collect();
    if (freeCells == empty) {
        System.out.println("No room in heap for new cells");
        return !OK;
    }
    if (p == rootCnt)
        rootCnt++;
    roots[p] = freeCells;
    freeCells    = detach(roots[p], freeCells);
    nonFreeCells = insert(roots[p], nonFreeCells);
    return OK;
}
}

```

*Continues*

**FIGURE 12.16** *(continued)*

```

public void allocateAtom (int p, int val) {    // an instance of Lisp's setf;
    if (allocateAux(p) == OK) {
        heap[roots[p]].atom = true;
        heap[roots[p]].info = new Value(val);
    }
}
public void allocateNonAtom(int p, int q, int r) { // Lisp's cons;
    if (allocateAux(p) == OK) {
        heap[roots[p]].atom = false;
        heap[roots[p]].info = new Links(roots[q],roots[r]);
    }
}
public void deallocate(int p) {
    if (rootCnt > 0)
        if (Math.abs(rd.nextInt()) % 2 == 0)
            roots[p] = roots[--rootCnt]; // remove variable when exiting a
            // block;
        else roots[p] = empty; // set variable to null;
}
private void printList(int list, String name) {
    System.out.print(name + ": ");
    for (int i = list; i != empty; i = heap[i].next) {
        System.out.print("(" + i + " ");
        if (heap[i].atom)
            System.out.print(((Value)heap[i].info).value);
        else if (heap[i].info != null)
            System.out.print(((Links)heap[i].info).head + " " +
                ((Links)heap[i].info).tail);
        System.out.print(") ");
    }
    System.out.println();
}
private void printHeap() {
    System.out.print("roots: ");
    for (int i = 0; i < rootCnt; i++)
        System.out.print(roots[i] + " ");
    System.out.println();
    for (int i = 0; i < maxHeap; i++) {
        System.out.print("(" + i + ": " + heap[i].prev + " "
            + heap[i].next + " "+ heap[i].atom + " " + heap[i].marked + " ");
    }
}

```

**FIGURE 12.16** (continued)

```

        if (heap[i].atom)
            System.out.print(((Value)heap[i].info).value);
        else if (heap[i].info != null)
            System.out.print(((Links)heap[i].info).head + " " +
                ((Links)heap[i].info).tail);
        System.out.print(" ");
    }
    System.out.println();
    printList(freeCells, "FreeCells");
    printList(nonFreeCells, "NonFreeCells");
}
}

//***** Collector.java *****

import java.util.Random;

public class Collector {
    private Heap heap = new Heap();
    private Random rd = new Random(10);
    private int val = 123;
    private void program() {
        int rn, p, q = 1, r = 1;
        if (heap.rootCnt() == 0) { // call heap.allocateAtom(0, val++);
            p = 0;
            rn = 1;
        }
        else {
            rn = Math.abs(rd.nextInt()) % 100 + 1;
            p = Math.abs(rd.nextInt()) % (heap.rootCnt()+1); // possibly
            q = Math.abs(rd.nextInt()) % heap.rootCnt(); // new root;
            r = Math.abs(rd.nextInt()) % heap.rootCnt();
        }
        if (rn <= 20)
            heap.allocateAtom(p, val++);
        else if (rn <= 40)
            heap.allocateNonAtom(p, q, r);
        else if (rn <= 60)
            heap.updateHead(q, r);
        else if (rn <= 80)

```

*Continues*

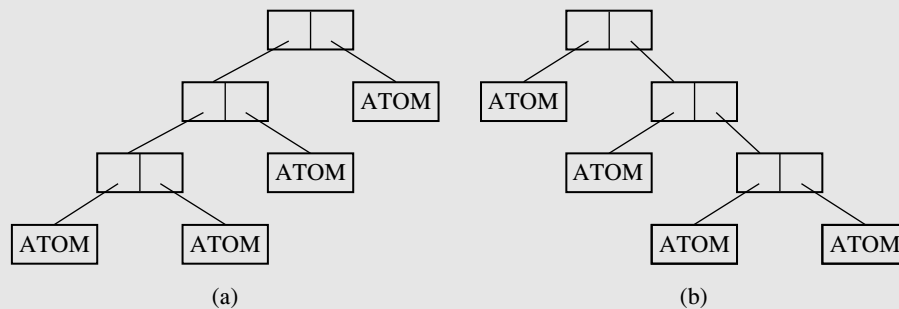
**FIGURE 12.16** *(continued)*

```
        heap.updateTail(q,r);
    else heap.deallocate(p);
    heap.printHeap();
}
static public void main(String a[]) {
    Collector c = new Collector();
    for (int i = 0; i < 50; i++)
        c.program();
}
}
```

## 12.6 EXERCISES

1. What happens to the first-fit method if it is applied to a list ordered by block sizes?
2. How does the effort leading to coalescing blocks in sequential-fit methods depend on the order of blocks on the list? How can possible problems caused by these orders be solved?
3. The *optimal-fit* method determines which block to allocate after examining a sample of blocks to find the closest match to the request, and then finds the first block exceeding this match (Campbell, 1971). What does the efficiency of this method depend on? How does this algorithm compare to the efficiency of other sequential-fit methods?
4. In what circumstances can the size-list in the adaptive exact-fit method be empty (except at the beginning)? What is its maximal size, and when can it be this size?
5. Why in the buddy system are doubly linked, not singly linked, lists of blocks used?
6. Give an algorithm for returning blocks to the memory pool using the Fibonacci buddy system.
7. Apply `markingWithStack()` to the left degenerate and right degenerate list structures in Figure 12.17. How many calls to `pop()` and `push()` are executed for each case? Are all of them necessary? How would you optimize the code to avoid unnecessary operations?

**FIGURE 12.17** (a) Left degenerate and (b) right degenerate list structures.



8. In a *reference count method* of garbage collection, each cell  $c$  has a counter field whose value indicates how many other cells refer (point) to it. The counter is incremented every time another cell refers to  $c$  and decremented if a reference is deleted. The garbage collector uses this counter when sweeping the heap: If a cell's count is zero,

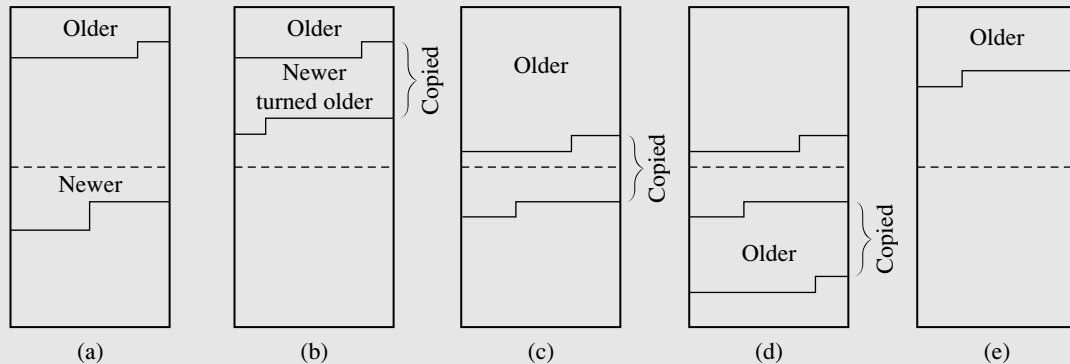
the cell can be reclaimed because it is not pointed to by any other cell. Discuss the advantages and disadvantages of this garbage collection method.

9. In Baker's algorithm, the scanning performed by the collector should be finished before *bottom* reaches *top* in tospace to flip spaces. What should the value of  $k$  be to ensure this? Assume that  $n$  is the maximum number of cells required by a program, and  $2m$  is the number of cells in fromspace and tospace. What is the impact of doubling the value of  $k$  when it is an integer and when it is a fraction (for example, if it is .5, then one copy is made per two requests)?
10. In a modification of Baker's algorithm that requires updating heap pages in the case when the mutator's access is trapped (Ellis, Li, and Appel, 1988), there is a problem with objects that may cross the page boundary. Suggest a solution to this problem.

## 12.7

### PROGRAMMING ASSIGNMENTS

1. Implement the following memory allocation method developed by W. A. Wulf, C. B. Weinstock, and C. B. Johnsson (Standish, 1980) called the *quick-fit* method. For an experimentally found number  $n$  of the most frequently requested sizes of blocks, this method uses an array *avail* of  $n + 1$  cells, each cell  $i$  pointing to a linked list of blocks of size  $i$ . The last cell ( $n + 1$ ) refers to a block of other less frequently needed sizes. It may also be a reference to a linked list, but because of possibly a large number of such blocks, another organization is recommended, such as a binary search tree. Write methods to allocate and deallocate blocks. If a block is returned, coalesce it with its neighbors. To test your program, randomly generate sizes of blocks to be allocated from memory simulated by an array whose size is a power of 2.
2. In the dual buddy system, two parts of memory are managed by the binary buddy method. But the number of such areas can be larger (Page and Hagins, 1986). Write a program to operate on three such areas with block sizes of the form  $2^i$ ,  $3 \cdot 2^j$ , and  $5 \cdot 2^k$ . For a requested block size  $s$ , round  $s$  to the nearest block size that can be generated by this method. For example, size 11 is rounded up to 12, which is the number from the second area. If this request cannot be accommodated in this area, 12 is rounded up to the next possibly available number, which is 15, a number from the third area. If there is no available block of this or greater size in this area either, the first area is tried. In case of failure, keep requests on a list and process them as soon as a block of sufficient size is coalesced. Run your program changing three parameters: the intervals for which blocks are reserved, the number of incoming requests, and the overall size of memory.
3. Implement a simple version of a generational garbage collector that uses only two regions (Appel, 1989). The heap is divided into two even parts. The upper part holds cells that have been copied from the lower part as cells reachable from the root pointers. The lower part is used for memory allocation and holds only newer cells (see Figure 12.18a). After this part becomes full, the garbage collector cleans it by copying all reachable cells to the upper part (Figure 12.18b), after which allocations

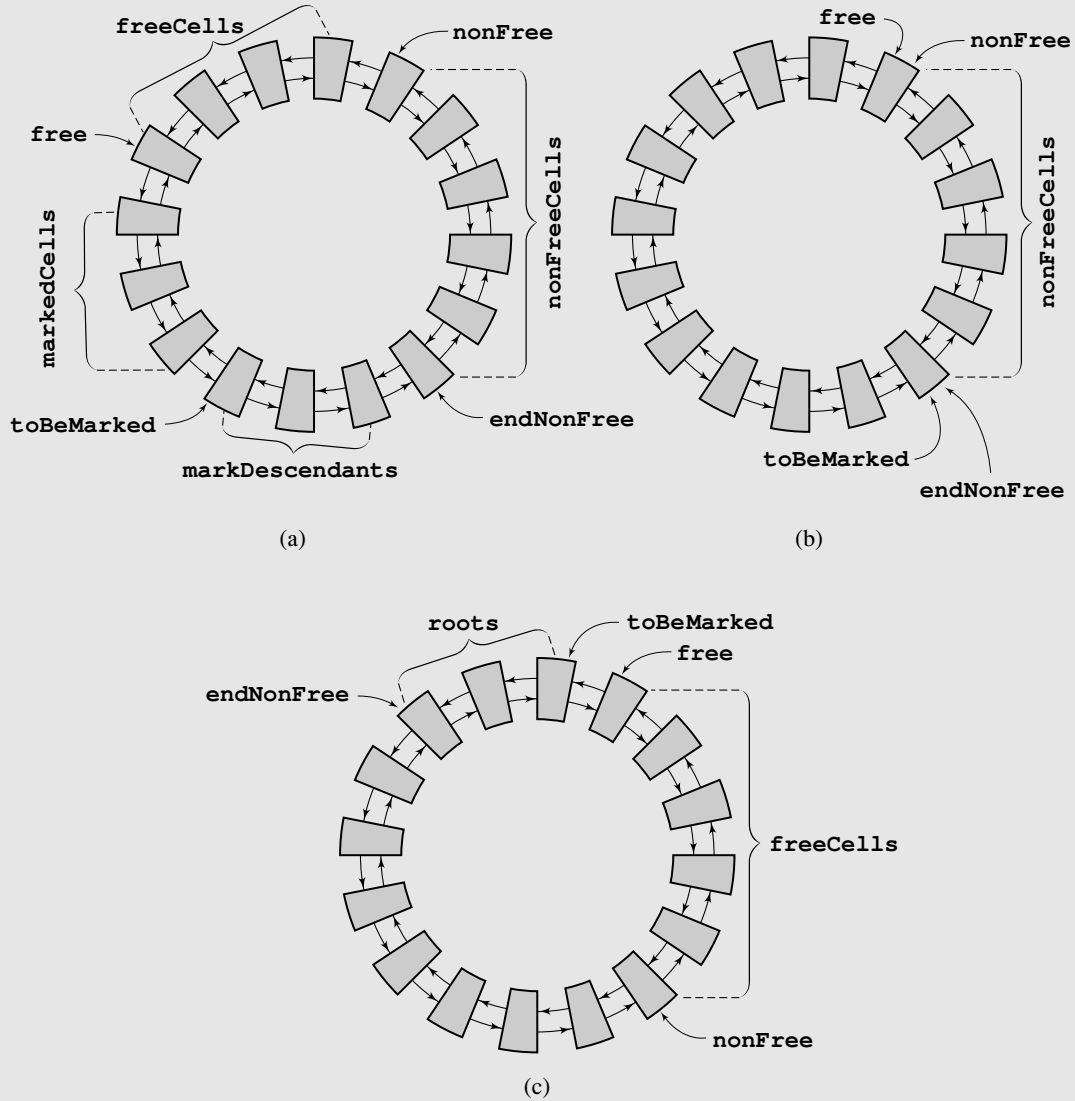
**FIGURE 12.18** A heap with two regions for Appel's generational garbage collection.

are made starting from the beginning of the lower part. After several turns, the upper part becomes full too, and the cells being copied from the lower part are in reality copied to the lower part (Figure 12.18c). In this case, the cleanup process of the upper part is begun by copying all reachable cells from the upper part to the lower part (Figure 12.18d), and then all reachable cells are copied to the beginning of the upper part (Figure 12.18e).

4. The case study presents an in-place nonincremental garbage collector. Modify and extend it to become an incremental collector. In this case, `program()` becomes `mutator()`, which allows the method `collect()` to process `k` cells for some value of `k`. To prevent `mutator()` from introducing inconsistencies in structures possibly not completely processed by `collect()`, `mutator()` should transfer any unmarked cells from `freeCells` to `markDescendants`.

Another very elegant modification is obtained by grouping all four lists in a circular list, creating what Henry Baker (1992) called a *treadmill* (Figure 12.19a). Reference `free` is moved in a clockwise direction if a new cell is requested; reference `toBeMarked` is moved `k` times when allowed by the mutator. For each nonatom cell currently scanned by `toBeMarked`, its *head* and *tail* are transferred in front of `toBeMarked` if they are not marked. After `toBeMarked` meets `endNonFree`, there are no cells to be marked, and after `free` meets `nonFree`, there are no free cells on the list of free cells (Figure 12.19b). In this case, what remains between `nonFree` and `endNonFree` (former `nonFreeCells`) is garbage, and hence, it can be utilized by the mutator. Therefore, the roles of `nonFree` and `endNonFree` are exchanged; it is as though `nonFreeCells` became `freeCells` (Figure 12.19c). All root pointers are transferred to a part of the treadmill between `toBeMarked` and `endFree` (to create a seed of the former `markDescendants`), and the mutator can resume execution.

**FIGURE 12.19** Baker's treadmill.





## BIBLIOGRAPHY

### *Memory Management*

Smith, Harry F., *Data Structures: Form and Function*, San Diego, CA: Harcourt-Brace-Jovanovich (1987), Ch. 11.

Standish, Thomas A., *Data Structure Techniques*, Reading, MA: Addison-Wesley (1980), Chs. 5 and 6.

### *Sequential-Fit Methods*

Campbell, J. A., "A Note on an Optimal-Fit Method for Dynamic Allocation of Storage," *Computer Journal* 14 (1971), 7–9.

### *Nonsequential-Fit Methods*

Oldehoeft, Rodney R., and Allan, Stephen J., "Adaptive Exact-Fit Storage Management," *Communications of the ACM* 28 (1985), 506–511.

Ross, Douglas T., "The AED Free Storage Package," *Communications of the ACM* 10 (1967), 481–492.

### *Buddy Systems*

Bromley, Allan G., "Memory Fragmentation in Buddy Methods for Dynamic Storage Allocation," *Acta Informatica* 14 (1980), 107–117.

Cranston, Ben, and Thomas, Rick, "A Simplified Recombination Scheme for the Fibonacci Buddy System," *Communications of the ACM* 18 (1975), 331–332.

Hinds, James A., "An Algorithm for Locating Adjacent Storage Blocks in the Buddy System," *Communications of the ACM* 18 (1975), 221–222.

Hirschberg, Daniel S., "A Class of Dynamic Memory Allocation Algorithms," *Communications of the ACM* 16 (1973), 615–618.

Knowlton, Kenneth C., "A Fast Storage Allocator," *Communications of the ACM* 8 (1965), 623–625.

Page, Ivor P., and Hagins, Jeff, "Improving Performance of Buddy Systems," *IEEE Transactions on Computers* C-35 (1986), 441–447.

Shen, Kenneth K., and Peterson, James L., "A Weighted Buddy Method for Dynamic Storage Allocation," *Communications of the ACM* 17 (1974), 558–562.

### *Garbage Collection*

Appel, Andrew W., "Garbage Collection Can Be Faster Than Stack Allocation," *Information Processing Letters* 25 (1987), 275–279.

Appel, Andrew W., "Simple Generational Garbage Collection and Fast Allocation," *Software—Practice and Experience* 19 (1989), 171–183.

- Baker, Henry G., "List Processing in Real Time on a Serial Computer," *Communications of the ACM* 21 (1978), 280–294.
- Baker, Henry G., "The Treadmill: Real-Time Garbage Collection Without Motion Sickness," *ACM SIGPLAN Notices* 27 (1992), No. 3, 66–70.
- Brooks, Rodney A., "Trading Data Space for Reduced Time and Code Space in Real-Time Collection on Stock Hardware," *Conference Record of the 1984 ACM Symposium on Lisp and Functional Programming*, Austin, TX (1984), 108–113.
- Cheney, C. J., "A Nonrecursive List Compacting Algorithm," *Communications of the ACM* 13 (1970), 677–678.
- Cohen, Jacques, "Garbage Collection of Linked Data Structures," *Computing Surveys* 13 (1981), 341–367.
- Ellis, John R., Li, Kai, and Appel, Andrew W., "Real-Time Concurrent Collection on Stock Multiprocessors," *SIGPLAN Notices* 23 (1988), No. 7, 11–20.
- Fenichel, Robert R., and Yochelson, Jerome C., "A Lisp Garbage-Collector for Virtual-Memory Computer Systems," *Communications of the ACM* 12 (1969), 611–612.
- Jones, Richard, and Lins, Rafael, *Garbage Collection: Algorithms for Automatic Dynamic Memory Management*, Chichester, United Kingdom: Wiley, 1996.
- Kurokawa, Toshiaki, "A New Fast and Safe Marking Algorithm," *Software—Practice and Experience* 11 (1981), 671–682.
- Layer, D. Kevin, and Richardson, Chris, "Lisp Systems in the 1990s," *Communications of the ACM* 34 (1991), No. 9, 49–57.
- Lieberman, Henry, and Hewitt, Carl, "A Real-Time Garbage Collector Based on the Lifetimes of Objects," *Communications of the ACM* 26 (1983), 419–429.
- Schorr, H., and Waite, W. M., "An Efficient Machine-Independent Procedure for Garbage Collection in Various List Structures," *Communications of the ACM* 10 (1967), 501–506.
- Wadler, Philip L., "Analysis of Algorithm for Real-Time Garbage Collection," *Communications of the ACM* 19 (1976), 491–500, 20 (1977), 120.
- Wegbreit, Ben, "A Space-Efficient List Structure Tracing Algorithm," *IEEE Transactions on Computers* C-21 (1972), 1009–1010.
- Wilson, Paul R., "Uniprocessor Garbage Collection Techniques," in Bekkers, Yves, and Cohen, Jacques (eds.), *Memory Management*, Berlin: Springer (1992), 1–42.
- Yuasa, Taiichi, "Real-Time Garbage Collection on General-Purpose Machine," *Journal of Systems and Software* 11 (1990), 181–198.
- Zorn, Benjamin, "Comparing Mark-and-Sweep and Stop-and-Copy Garbage Collection," *Proceedings of the 1990 ACM Conference on Lisp and Functional Programming* (1990), 87–98.

# String Matching

# 13

String matching is important for virtually each computer user. When editing a text, the user processes it, organizes it into paragraphs and sections, reorders it, and, very often, searches for some subtext or pattern in the text to locate the pattern or replace it with something else. The larger the text that is being searched for a pattern, the more important is the efficiency of the searching algorithm. The algorithm cannot usually rely on, say, alphabetical ordering of words, as would be the case with a dictionary. For example, string searching algorithms are increasingly important in molecular biology, where they are used to extract information from DNA sequences by locating some pattern in them and comparing the sequences for common subsequences. Such processing has to be done frequently, under the assumption that an exact match cannot be expected. Problems of that type are addressed by what is often called *stringology*, whose major area of interest is *pattern matching*. Some stringological problems are discussed in this chapter.

This chapter uses the following notation: For a text  $T$ , which is a sequence of symbols, characters, or letters,  $|T|$  signifies the length of  $T$ ,  $T_j$  is the character at position  $j$  of  $T$ , and  $T(i \dots j)$  is a substring of  $T$  that begins at position  $i$  and ends at  $j$ . The first characters in pattern  $P$  and text  $T$  are in position 0. Also, a *regular expression*  $a^n$  stands for a string  $a \dots a$  of  $n$   $a$ s.

## 13.1

### EXACT STRING MATCHING

Exact string matching consists of finding an exact copy of pattern  $P$  in text  $T$ . It is an all-or-nothing approach; if there is a very close similarity between  $P$  and a substring of  $T$ , the partial match is rejected.

#### 13.1.1 Straightforward Algorithms

A simple approach to string matching is starting the comparison of  $P$  and  $T$  from the first letter of  $T$  and the first letter of  $P$ . If a mismatch occurs, the matching begins from



The corresponding characters in  $P$  and  $T$  are compared—which is marked by underlining characters in  $P$ —starting at the position where  $P$  is currently aligned with  $T$ . After a mismatch is found, the scan through  $P$  and  $T$  is aborted and restarted after  $P$  is shifted to the right by one position. In the first iteration, the matching process begins at the first characters of  $P$  and  $T$ , and a mismatching occurs at the fifth character of  $T(T_4 = c)$ , and the fifth character of  $P(P_4 = a)$ . The next round begins from the first character of  $P$ , but this time, from the second character of  $T$ , which immediately leads to a mismatch. The third iteration reaches the third character of  $P$ , and the fifth character of  $T$ ,  $c$ . The match of the entire pattern  $P$  is found in the tenth iteration.

Note that no actual shifting takes place; the shifting is accomplished by updating index  $i$ .

An improvement is accomplished by a not-so-naïve algorithm proposed by Hancart (1992). It begins comparisons from the second character of  $P$ , goes to the end, and ends comparisons with the first character. So the order of characters involved in comparisons is  $P_1, P_2, \dots, P_{|P|-1}, P_0$ .

The information about equality of the first two characters of  $P$  is recorded and used in the matching process. Two cases are distinguished:  $P_0 = P_1$  and  $P_0 \neq P_1$ . In the first case, if  $P_1 \neq T_{i+1}$ , text index  $i$  is incremented by 2, because  $P_0 \neq T_{i+1}$ ; otherwise,  $i$  is incremented by 1. It is similar in the second case, if  $P_1 = T_{i+1}$ . In this way, a shift by two positions is possible. Here is the algorithm:

```
Hancart(pattern P, text T)
  if P0 == P1
    sEqual = 1;
    sDiff = 2;
  else sEqual = 2;
    sDiff = 1;
  i = 0;
  while i ≤ |T| - |P|
    if Ti+1 ≠ P1
      i = i + sDiff;
    else j = 1;
      while j < |P| and Ti+j == Pj
        j++;
      if j == |P| and P0 == Ti
        return match at i;
      i = i + sEqual;
  return no match;
```

Matching begins from the second pattern character. If there is a mismatch between  $P_1$  and  $T_{i+1}$ , then  $P$  can be shifted by two positions before beginning the next round, as long as the first two characters of  $P$  are the same, because this mismatch means that  $P_0$  and  $T_{i+1}$  are also different:

```

i
↓
acaaca
1 aab
2  aab
```

However, after a mismatch occurs in the inner `while` loop, the pattern is shifted by only one position:

```

      i
      ↓
    acaaca
  2  aab
  3  aab

```

On the other hand, if the first two characters of  $P$  are different, then after noticing in the `if` statement that  $P_1$  and  $T_{i+1}$  are different,  $P$  is shifted by one position only:

```

      i
      ↓
    aabaca
  1  abb
  2  abb

```

so that a possible occurrence of  $P$  is not missed. However, after a mismatch is found in any other position,  $P$  is shifted by two places:

```

      i
      ↓
    aabaca
  2  abb
  3  aab

```

This can be done safely, because  $P_1$  and  $T_{i+1}$  have just been determined as equal and because  $P_0$  and  $P_1$  are different,  $P_0$  and  $T_{i+1}$  must be also different, thus there is no need to check this in the third iteration. Here is another example:

```

    ababcdabbabababad
  1  abababa
  2  abababa
  3  abababa
  4  abababa
  5  abababa
  6  abababa
  7  abababa

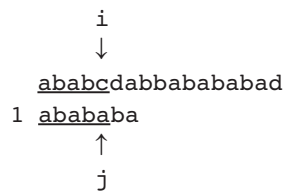
```

In the worst case, the algorithm executes in  $O(|T||P|)$  time, but, as Hancart shows, it performs on average better than some of the more developed algorithms to be discussed in the next section.

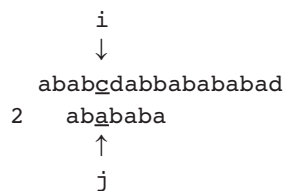
### 13.1.2 The Knuth-Morris-Pratt Algorithm

The brute force algorithm is inefficient in that it shifts pattern  $P$  by one position after a mismatch is found. To speed up the process, Hancart's algorithm allows for a shift by two characters. However, a method is needed to shift  $P$  by as many positions to the right as possible, but so that no match is missed.

The source of inefficiency of the brute force algorithm lies in performing redundant comparisons. The redundancy can be avoided by observing that pattern  $P$  includes identical substrings at the beginning of  $P$  and before the mismatched character. This fact can be used to shift  $P$  to the right by more than one position before beginning the next scan. Consider line 1 of the following diagram. The mismatch occurs at the fifth character, but until that point, both the prefix  $ab$  of  $P$  and the substring  $P(2 \dots 3)$ , which is also  $ab$ , have been successfully processed.  $P$  can now be moved to the right to align its prefix  $ab$  with the substring  $T(2 \dots 3)$ , and the matching process can start from character  $P_2$  and from the mismatched character in  $T$ ,  $T_4$ . Because characters in the substring  $P(2 \dots 3)$  have just been successfully matched with  $T(2 \dots 3)$ , it is as though the characters in the prefix  $P(0 \dots 1)$  were matched with  $T(2 \dots 3)$ . In this way, the two redundant comparisons in line 2 can be omitted. After the mismatch



the matching process continues as in



thereby skipping  $ab = P(0 \dots 1)$ . The two identical parts relevant to this shift are the prefix of  $P$  and suffix of this part of  $P$  that is currently successfully matched, which is the prefix  $P(0 \dots 1)$  and the suffix  $P(2 \dots 3)$  of the matched part of  $P$ ,  $P(0 \dots 3)$ .

Generally, to perform a shift, we first need to match a prefix of  $P$  with a suffix of  $P(0 \dots j)$ , where  $P_{j+1}$  is a mismatched character. This matching prefix should be the longest possible so that no potential match is passed after shifting  $P$ ; that is, if the match is of length  $len$  and the current scan starts at position  $k$  of  $T$ , then no occurrence of  $P$  should begin in any position between  $k$  and  $k + len$ , but it may begin at position  $k + len$ , so that shifting  $P$  by  $len$  positions is safe.

This information will be used many times during the matching process; therefore,  $P$  should be preprocessed. Importantly, in this approach only the information about  $P$  is used; the configuration of characters in  $T$  is irrelevant.

Define the table *next*:

$$next[j] = \begin{cases} -1 & \text{for } j = 0 \\ \max\{k: 0 < k < j \text{ and } P[0 \dots k-1] = P[j-k \dots j-1]\} & \text{if such a } k \text{ exists} \\ 0 & \text{otherwise} \end{cases}$$

that is, the number  $next[j]$  indicates the length of the longest suffix of substring  $P(0 \dots j-1)$  equal to a prefix of the same substring:

$$\begin{array}{ccccccc}
 & & j - next[j] & & j - 1 & & \\
 & & \downarrow & & \downarrow & & \\
 \underline{a \dots bc} & \dots & \underline{da \dots be} & \dots & & & \\
 \uparrow & \uparrow & & & & & \\
 0 & next[j] & & & & & 
 \end{array}$$

The condition  $k < j$  indicates that the prefix is also a proper suffix. Without this condition,  $next[2]$  for  $P(0 \dots 2) = aab$  would be 2, because  $aa$  is at the same time a prefix and suffix of  $aa$ , but with the additional condition,  $next[2] = 1$ , not 2.

For example, for  $P = abababa$ ,

$P$	a	b	a	b	a	b	a
$j$	0	1	2	3	4	5	6
$next[j]$	-1	0	0	1	2	3	4

Note that because of the condition requiring that the matching suffix be the longest,  $next[5] = 3$  for  $P(1 \dots 6) = ababab$ , because  $aba$  is the longest suffix of  $ababab$  matching its prefix (they overlap), not 1, although  $a$  is also both a prefix and a suffix of  $ababab$ .

The Knuth-Morris-Pratt algorithm can be obtained relatively easily from `bruteForceStringMatching()`:

```

KnuthMorrisPratt(pattern P, text T)
    findNext(P, next);
    i = j = 0;
    while i ≤ |T| - |P|
        while j == -1 or j < |P| and Ti == Pj
            i++;          // increment i only for matched characters;
            j++;
        if j == |P|
            return a match at i - |P|;
        j = next[j]      // in the case of a mismatch, i does not change;
    return no match;

```

The algorithm `findNext()` to determine the table  $next$  will be defined shortly. For example, for  $P = abababa$ ,  $next = [-1 0 0 1 2 3 4]$ , and  $T = ababcdabbabababad$ , the algorithm executes as follows:

```

ababcdabbabababad
1 abababa
2 abababa
3 abababa
4 abababa
5 abababa
6 abababa
7 abababa

```



The diagram indicates that  $-1$  in *next* means that the entire pattern  $P$  should be shifted past the mismatched text character; see the shift from line 4 to 5 and from line 6 to 7. One major difference between `bruteForceStringMatching()` and `KnuthMorrisPratt()` is that  $i$  is never decremented in the latter algorithm. It is incremented in the case of a match; in the case of a mismatch  $i$  stays the same so that the mismatched character in  $T$  is compared to another character in  $P$  in the next iteration of the outer `while` loop. The only case when  $i$  is incremented in the case of mismatch is when the first character in  $P$  is a mismatched character; to this end the subcondition `j == -1` is needed in the inner loop. After finding a mismatch at position  $j \neq 0$  of  $P$ ,  $P$  is shifted by  $j - \text{next}[j]$  positions; when the mismatch occurs at the first position of  $P$ , the pattern is shifted by one position.

To assess the computational complexity of `KnuthMorrisPratt()`, note that the outer loop executes  $O(|T|)$  times. The inner loop executes at most  $|T| - |P|$  times, because  $i$  is incremented in each iteration of the loop, and by the condition on the outer loop,  $|T| - |P|$  is the maximum value for  $i$ . But for a mismatched character  $T_i$ ,  $j$  can be assigned a new value  $k \leq |P|$  times. When this happens, the first character in  $P$ , for which the mismatch occurs, is aligned with the character  $T_{i+k}$ . Consider  $P = \text{aaab}$  and  $T = \text{aaacaaadaaab}$ . In this case,  $\text{next} = [-1\ 0\ 1\ 2]$ , and the trace of the execution of the algorithm is as follows:

```

aaacaaadaaab
1  aaab
2   aaab
3    aab
4     aab
5      aaab
6       aaab
7        aab
8         aaab
9          aaab

```

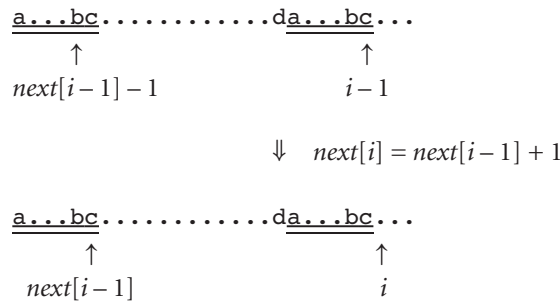
The mismatched  $c$  in  $T$  is compared to four characters in  $P$  in lines 1 through 4 because  $b$  is the fourth character in  $P$  for which the mismatch occurs for the first time and because  $b$  is aligned with  $c$ ; that is, all the preceding characters have already been matched successfully. The next time, such a situation occurs for  $d$  in  $T$  and again for  $b$  in  $P$  on line 5, and by this time all the preceding characters in  $P$  are successfully matched. This means that for some  $i$ ,  $|P|$  comparisons can be performed, but this can not happen for every  $i$ , but only for every  $|P|^{\text{th}}$   $i$ , so that the number of unsuccessful comparisons can be up to  $|P|(|T|/|P|) = |T|$ . Up to  $|T| - |P|$  successful comparisons have to be added to this number to obtain the running time  $O(|T|)$ .

The table *next* still remains to be determined. We can use the brute force algorithm to that end, which is not necessarily inefficient for short patterns. But we can also adapt the Knuth-Morris-Pratt algorithm to improve the efficiency of determining *next*.

Remember that *next* contains the lengths of the longest suffixes matching prefixes of  $P$ ; that is, parts of  $P$  are being matched with other parts of  $P$ . But the problem of matching is solved already by the Knuth-Morris-Pratt algorithm. In this case,  $P$  is matched against itself. However, the Knuth-Morris-Pratt algorithm uses *next*, which is

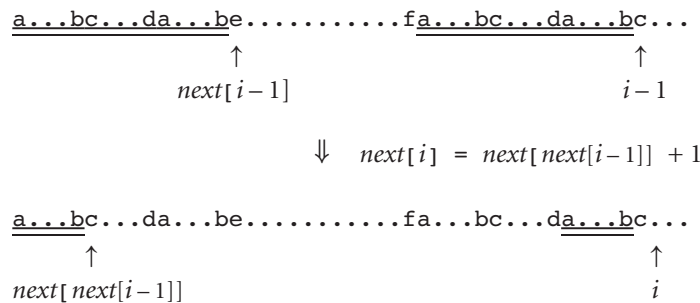
still unknown. Therefore, the Knuth-Morris-Pratt algorithm has to be modified so that it determines the values of the table *next* by using values already found. Let  $next[0] = -1$ . Assuming that values  $next[0], \dots, next[i - 1]$  have already been determined, we want to find the value  $next[i]$ . There are two cases to consider.

In the first case, the longest suffix matching a prefix is found by simply attaching the character  $P_{i-1}$  to the suffix corresponding to position  $next[i - 1]$ , which is true when  $P_{i-1} = P_{next[i-1]}$ :



In this case, the current suffix is longer by one character than the previously found suffix so that  $next[i] = next[i - 1] + 1$ .

In the second case,  $P_{i-1} \neq P_{next[i-1]}$ . But this is simply a mismatch, and a mismatch can be handled with the table *next*, which is why it is being determined. Because  $P_{next[i-1]}$  is a mismatched character, we need to go to  $next[next[i - 1]]$  to check whether  $P_{i-1}$  matches  $P_{next[next[i-1]]}$ . If they match,  $next[i]$  is assigned  $next[next[i - 1]] + 1$ :



otherwise  $P_{i-1}$  is compared to  $P_{next[next[next[i-1]]]}$  to have  $next[i] = next[next[next[i - 1]]] + 1$  if the characters match; if not, the search continues until a match is found or the beginning of *P* is reached.

Note that in the previous diagram, the first prefix  $a \dots bc \dots da \dots b$  of  $P(0 \dots i - 1)$  has a prefix  $a \dots b$  identical to its suffix. This is not an accident. The reason for  $a \dots b$  being both prefix and suffix of  $a \dots bc \dots da \dots b$  when  $a \dots b$  is about to be found as the longest prefix and suffix of  $P(0 \dots i - 1)$  is as follows. The prefix  $P(0 \dots j - 1) = a \dots bc \dots da \dots b$  of  $P(0 \dots i - 1)$  indicated by  $next[i - 1]$  is, by definition, equal to the suffix  $P(i - j - 1 \dots i - 2)$ , which means that the suffix  $P(j - next[j] \dots j - 1) = a \dots b$  is also a suffix of  $P(i - j - 1 \dots i - 2)$ . Therefore, to determine the value of  $next[i]$  we refer to the already determined value  $next[j]$  that specifies the length of this shorter suffix of  $P(0 \dots j - 1)$  matching a prefix of *P*, and thus the length of the suffix  $a \dots b$  of  $P(0 \dots i - 1)$  matching the same prefix.

The algorithm to find the table *next* is as follows:

```

findNext(pattern P, table next)
    next[0] = -1;
    i = 0;
    j = -1;
    while i < |P|
        while j == 0 or i < |P| and Pi == Pj
            i++;
            j++;
            next[i] = j;
        j = next[j];

```

Here is an example of finding *next* for pattern  $P = ababacdd$ . The values of indices  $i$  and  $j$  and the table *next* before entering the inner `while` loop are indicated with an arrow (and by the fact that  $i$  does not change); the remaining lines show these values at the end of the inner loop and a comparison that follows. For example, in line 2, after incrementing  $i$  to 1 and  $j$  to 0, 0 is assigned to  $next[1]$ , and then the first and second characters of  $P$  are compared, which leads to exiting the loop.

	$i$	$j$	$next[]$	$P$
→	0	-1	-1	ababacdd
	1	0	-1 0	<u>a</u> babacdd
→	1	-1	-1 0	
	2	0	-1 0 0	<u>ab</u> abacdd
	3	1	-1 0 0 1	<u>aba</u> bacdd
	4	2	-1 0 0 1 2	<u>abab</u> acdd
	5	3	-1 0 0 1 2 3	<u>ababa</u> cdd
→	5	1	-1 0 0 1 2 3	<u>ababa</u> <u>c</u> dd
→	5	0	-1 0 0 1 2 3	<u>ababa</u> <u>cd</u> d
→	5	-1	-1 0 0 1 2 3	
	6	0	-1 0 0 1 2 3 0	<u>ababac</u> dd
→	6	-1	-1 0 0 1 2 3 0	
	7	0	-1 0 0 1 2 3 0 0	<u>ababacdd</u>
→	7	-1	-1 0 0 1 2 3 0 0	
	8	0	-1 0 0 1 2 3 0 0	

Because of the similarity of this algorithm and the Knuth-Morris-Pratt algorithm, we conclude that *next* can be determined in  $O(|P|)$  time.

The outer `while` loop in `KnuthMorrisPratt()` executes in  $O(|T|)$  time, so the Knuth-Morris-Pratt algorithm, including `findNext()`, executes in  $O(|T| + |P|)$  time. Note that in the analysis of the complexity of the algorithm, no mention was made about the alphabet underlying the text  $T$  and pattern  $P$ ; that is, the complexity is independent of the number of different characters constituting  $P$  and  $T$ .

The algorithm requires no backtracking in text  $T$ ; that is, the variable  $i$  is never decremented during execution of the algorithm. This means that  $T$  can be processed one character at a time, which is very convenient for online processing.

The Knuth-Morris-Pratt algorithm can be improved if we eliminate unpromising comparisons. If the mismatch occurs for characters  $T_i$  and  $P_j$ , then the next match is attempted for the same character  $T_i$  and character  $P_{next[j]+1}$ . But if  $P_j = P_{next[j]+1}$  then

the same mismatch takes place, which means a redundant comparison is made. Consider  $P = abababa$  and  $T = ababcdabbabababad$ , analyzed earlier, for which  $next = [-1, 0, 0, 1, 2, 3, 4]$  and the Knuth-Morris-Pratt algorithm begins with:

```

ababcdabbabababad
1  abababa
2   abababa

```

The first mismatch occurs for  $a$  at the fifth position of  $P$  and for  $c$  in  $T$ . The table  $next$  indicates that in the case of the mismatch of the fifth character of  $P$ ,  $P$  should be shifted by two positions to the right, because  $4 - next[4] = 2$ ; that is, the two-character prefix of  $P$  should be aligned with the two-character suffix of  $P(0 \dots 3)$ . The situation is illustrated on the second line of the diagram. However, this means that the next comparison is made between  $c$  that just caused a mismatch and  $a$  at the third position of  $P$ . But this is a comparison that has just been made on line 1 of the diagram, where  $a$  in the fifth position of  $P$  was also compared to  $c$ . Therefore, if we knew that the prefix  $ab$  of  $P$  is followed by  $a$ , which is also a character following suffix  $ab$  of  $P(0 \dots 3)$ , then the situation of the second line of the diagram could be avoided. To accomplish it, the table  $next$  has to be redesigned to exclude such redundant comparisons. This is done by extending the definition of  $next$  by one more condition, which leads to the following definition of a stronger  $next$ :

$$nextS[j] = \begin{cases} -1 & \text{for } j = 0 \\ \max\{k: 0 < k < j \text{ and } P[0 \dots k-1] = P[j-k \dots j-1] \text{ and } P_{k+1} \neq P_j\} & \text{if such a } k \text{ exists} \\ 0 & \text{otherwise} \end{cases}$$

To compute  $nextS$ , the algorithm `findNext()` needs to be modified slightly to account for the additional condition, as in

```

findNextS(pattern P, table nextS)
  nextS[0] = -1;
  i = 0;
  j = -1;
  while i < |P|
    while j == -1 or i < |P| and Pi == Pj
      i++;
      j++;
      if Pi != Pj
        nextS[i] = j;
      else nextS[i] = nextS[j];
    j = nextS[j];

```

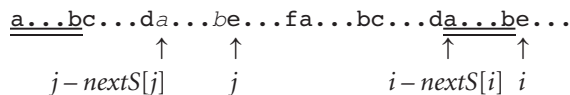
The rationale is as follows. If  $P_i \neq P_j$ —that is, the new subcondition defining  $nextS$  is satisfied—then clearly  $next[i]$  and  $nextS[i]$  are equal, and so  $nextS[i]$  in `findNextS()` is assigned the same value as  $next[i]$  in `findNext()`. If the characters  $P_i$  and  $P_j$  are equal,

```

a...bc...da...be...fa...bc...da...be...
      ↑      ↑      ↑
      j      i-j     i

```

then the subcondition is violated, thus  $nextS[i] < next[i]$ , and the situation is as follows



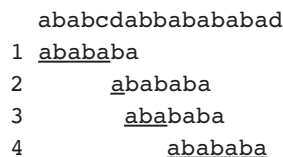
The underlined substrings are the proper prefix and suffix of  $P(0 \dots i - 1)$  indicated by  $\text{nextS}[i]$  that are shorter than  $\text{next}[i]$  (they can be empty). But the prefix  $P(0 \dots j - 1) = a \dots bc \dots da \dots b$  of  $P(0 \dots i - 1)$  indicated by  $\text{next}[i]$  is, by definition, equal to the suffix  $P(i - j \dots i - 1)$ , which means that the suffix  $P(j - \text{nextS}[j] \dots j - 1) = a \dots b$  shown in italic is also a suffix of  $P(i - j \dots i - 1)$ . Therefore, to determine the value of  $\text{nextS}[i]$  we refer to the already determined value  $\text{nextS}[j]$  that specifies the length of the italicized suffix of  $P(0 \dots j - 1)$  matching a prefix of  $P$ , and thus the length of the suffix of  $P(0 \dots i - 1)$  matching the same prefix. If the prefix is followed by the character  $P_j$ , then  $\text{nextS}[j]$  contains the length of a shorter prefix determined by the same process. For example, when processing position 11 in the string

$P = \underline{abcabdabcabdfabcabdabcabd}$   
 $\text{nextS} = \dots\dots 2 \dots\dots 2 \dots\dots\dots$

number 2 is copied to  $\text{nextS}[11]$  from  $\text{nextS}[5]$ , and the same number from position 11—that is, indirectly, from position 5—to  $\text{nextS}[24]$ :

$P = \underline{abcabdabcabdfabcabdabcabd}$   
 $\text{nextS} = \dots\dots 2 \dots\dots 2 \dots\dots\dots 2$

The Knuth-Morris-Pratt algorithm is modified by replacing  $\text{findNext}()$  with  $\text{findNextS}()$ . The execution of this algorithm for  $P = abababa$  generates  $\text{nextS} = [-1 \ 0 \ -1 \ 0 \ -1 \ 0 \ -1]$  and then continues with comparisons as summarized in this diagram:

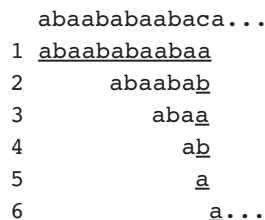


The Knuth-Morris-Pratt algorithm exhibits the worst case performance for Fibonacci words defined recursively as follows:

$$F_1 = b, F_2 = a, F_n = F_{n-1}F_{n-2} \text{ for } n > 2$$

The words are:  $b, a, ab, aba, abaab, abaababa, \dots$

In the case of mismatch, a Fibonacci word  $F_n$  can be shifted  $\log_{\varphi} |F_n|$  times, where  $\varphi = (1 + \sqrt{5})/2$  is the golden ratio. If the pattern  $P = F_7 = abaababaabaab$ , the Knuth-Morris-Pratt algorithm executes as follows:



### 13.1.3 The Boyer-Moore Algorithm

In the Knuth-Morris-Pratt algorithm, each of the first  $|T| - |P| + 1$  characters is used at least once in a comparison for an unsuccessful search. The source of this algorithm's better efficiency over the brute force approach lies in not starting the matching process from the beginning of pattern  $P$  when a mismatch is detected, if possible. So the Knuth-Morris-Pratt algorithm goes through almost all characters in  $T$  from left to right and tries to minimize the number of characters in  $P$  involved in matching. It is not possible to skip any characters in  $T$  itself to avoid unpromising comparisons. To accomplish such skipping, the Boyer-Moore algorithm tries to match  $P$  with  $T$  by comparing them from right to left, not from left to right. In the case of a mismatch, it shifts  $P$  to the right and always begins the next matching from the end of  $P$ , but it shifts  $P$  to the right so that many characters in  $T$  are not involved in the comparisons. Thus, the Boyer-Moore algorithm attempts to gain speed by skipping characters in  $T$  rather than, as the Knuth-Morris-Pratt algorithm does, skipping them in  $P$ , which is more prudent because the length of  $P$  is usually negligible in comparison to the length of  $T$ .

The basic idea is very simple. In the case of detecting a mismatch at character  $T_i$ ,  $P$  is shifted to the right to align  $T_i$  with the first encountered character equal to  $T_i$ , if such a character exists. For example, for  $T = \text{aaaaebdaabadbda}$  and  $P = \text{dabacbd}$ , first, characters  $T_6 = d$  and  $P_6 = d$ , then characters  $T_5 = b$  and  $P_5 = b$  are compared, and then the first mismatch is found at  $T_4 = e$  and  $P_4 = c$ . But there is no occurrence of  $e$  in  $P$ . This means that there is no character in  $P$  to be aligned with  $e$  in  $T$ ; that is, no character can be successfully matched with  $e$ . Therefore,  $P$  can be shifted to the right past the mismatched character:

```

    aaaaebdaabadbda
1  dabacbd
2      dabacbd

```

In this way, the first four characters of the text are excluded from later comparisons. Now, matching starts from the end of  $P$  and from position  $11 = 4 + 7 =$  (the position of the mismatched character  $T_4$ )  $+ |P|$ . A mismatch is found at  $T_{10} = a$  and  $P_5 = b$ , and then the mismatched  $a$  is aligned with the first  $a$  to the left of mismatched  $P_5$ :

```

    aaaaebdaabadbda
2      dabacbd
3      dabacbd

```

that is, the position in  $T$  from which the matching process starts in the third line is  $13 = 10 + 3 =$  (the position of the mismatched character  $T_{10} = a$ )  $+ (|P| -$  position of the rightmost  $a$  in  $P$ ). After matching characters  $T_{13}$  with  $P_6$  and  $T_{12}$  with  $P_5$ , a mismatch is found at  $T_{11} = d$  and  $P_4 = c$ . If we aligned the mismatched  $d$  in text with the rightmost  $d$  in  $P$ ,  $P$  would be moved backwards. Therefore, if there is a character in  $P$  equal to the mismatched character in  $T$  to the left of the mismatched character in  $P$ , the pattern  $P$  is shifted to the right by one position only:

```

      aaaaebdaabadbda
3      dabacbd
4      dabacbd

```

To sum up, the three rules can be termed character occurrence rules:

1. *No occurrence rule.* If the mismatched character  $T_i$  appears nowhere in  $P$ , align  $P_0$  with  $T_{i+1}$ .
2. *Right side occurrence rule.* If there is a mismatch at  $T_i$  and  $P_j$ , and if there is an occurrence of character  $ch$  equal to  $T_i$  to the right of  $P_j$ , shift  $P$  by one position.
3. *Left side occurrence rule.* If there is an occurrence of character  $ch$  equal to  $T_i$  only to the left of  $P_j$ , align  $T_i$  with  $P_k = ch$  closest to  $P_j$ .

To implement the algorithm, a table *delta1* specifies, for each character in the alphabet, by how much to increment  $i$  after a mismatch is detected. The table is indexed with characters and is defined as follows:

$$\text{delta1}[ch] = \begin{cases} |P| & \text{if } ch \text{ is not in } P \\ \min\{|P| - i - 1 : P_i = ch\} & \text{otherwise} \end{cases}$$

For the pattern  $P = \text{dabacbd}$ ,  $\text{delta1}[\text{'a'}] = 3$ ,  $\text{delta1}[\text{'b'}] = 1$ ,  $\text{delta1}[\text{'c'}] = 2$ ,  $\text{delta1}[\text{'d'}] = 0$ , and for remaining characters  $ch$ ,  $\text{delta1}[ch] = 7$ .

The algorithm itself can be summarized as follows:

```

BoyerMooreSimple(pattern P, text T)
  initialize all cells of delta1 to |P|;
  for j = 0 to |P| - 1
    delta1[P_j] = |P| - j - 1;
  i = |P| - 1;
  while i < |T|
    j = |P| - 1;
    while j ≥ 0 and P_j == T_i
      i--;
      j--;
    if j == -1
      return match at i+1;
    i = i + max(delta1[T_i], |P| - j);
  return no match;

```

In the algorithm,  $i$  is incremented by  $\text{delta1}[T_i]$  if the character  $T_i$  that caused a mismatch has in  $P$  an equivalent to the left of character  $P_j$  that caused the same mismatch and none to its right, which means shifting  $P$  to the right by  $\text{delta1}[T_i] - (|P| - j)$  positions; otherwise,  $i$  is incremented by  $|P| - j$ , which is tantamount to shifting  $P$  by one position to the right. Without the latter provision,  $P$  would be shifted backwards to align the two characters.

In the worst case the algorithm executes in  $O(|T||P|)$  time; for example, if  $P = ba^{m-1}$  and  $T = a^n$ . Note that in this case, the algorithm rechecks characters in  $T$  that have already been checked.

The algorithm can be improved if we take into account the entire substring that follows a mismatched character  $P_j$ . Consider the following shift

```

aaabcabcbabbaecabcab
1  abdabcabcab
2  abdabcabcab

```

which shifts  $P$  by one position in accordance with the left side occurrence rule. But a longer shift can result from aligning the substring of  $T$  equal to the already matched suffix that *directly* follows the mismatched character  $P_8 = b$  with an equal substring in  $P$  that begins to the left of  $P_8$ .

```

aaabcabcbabbaecabcab
1  abdabcabcab
2  abdabcabcab

```

However, note that after the shift, the mismatched character  $b$  in  $T$  is again aligned with  $c = P_5$ , which just caused a mismatch. Therefore, if matching ever reaches  $c$  after restarting from the end of  $P$ , the mismatch is guaranteed to reoccur. To avoid this mismatch, it is better to align the suffix  $ab$  of  $P$  that directly follows  $P_8 = c$  with an equal substring of  $P$  that is preceded by a different character than  $c$ . In our example, substring  $ab$  in  $P$  that follows the mismatched character  $P_8$  should be aligned with  $ab$  preceded by  $d$  because it is different from  $c$ :

```

aaabcabcbabbaecabcab
1  abdabcabcab
2  abdabcabcab

```

after which the matching process restarts from the end of  $P$ .

What should be the shift if no substring begins to the left of a mismatched character  $P_j$  and is equal to the suffix that directly follows  $P_j$ ? For example, what should be the shift after a mismatch is found in line 2? In this case, we align the longest suffix of  $P$  that follows the mismatched character  $P_j$  with an equal prefix of  $P$ :

```

aaabcabcbabbaecabcab...
2  abdabcabcab
3  abdabcabcab

```

To sum up, there are two cases to consider:

1. *A full suffix rule.* If a mismatched character  $P_j$  is directly followed by a suffix that is equal to a substring of  $P$  that begins anywhere to the left of  $P_j$ , align the suffix with the substring.
2. *A partial suffix rule.* If there is a prefix of  $P$  equal to the longest suffix anywhere to the right of the mismatched character  $P_j$ , align the suffix with the prefix.

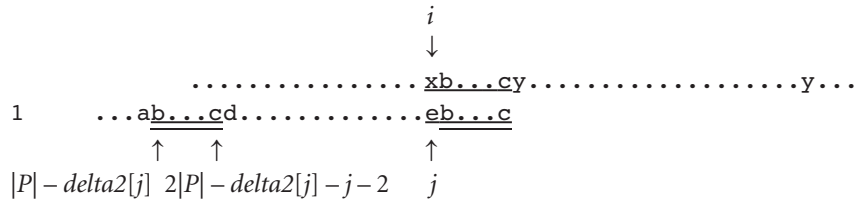
To accomplish these shifts, a table *delta2* is created that for each position in  $P$  holds a number by which the index  $i$  that scans  $T$  has to be incremented to restart the matching process; that is, if a mismatched character is  $P_j$ , then  $i$  is incremented by *delta2*[ $j$ ] (and  $j$  is set to  $|P| - 1$ ). Formally, *delta2* is defined as follows:

$$\text{delta2}[j] = \min\{s + |P| - j - 1 : 1 \leq s \text{ and } (j \leq s \text{ or } P_{j-s} \neq P_j) \text{ and for } j < k < |P| : (k \leq s \text{ or } P_{k-s} = P_k)\}$$

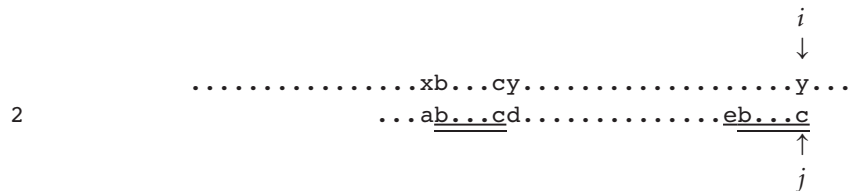


and  $\text{delta2}[|P| - 1] = \text{delta2}[|P| - 2]$  if the last two characters in  $P$  are the same (if they are different, then  $\text{delta2}[|P| - 1] = 1$ , because the third subcondition in the definition, “for . . .”, is vacuously true).

There are, as already indicated, two cases. In the first case, the suffix directly following the mismatched character  $P_j$  has a matching substring in  $P$ , so the situation after detecting a mismatch

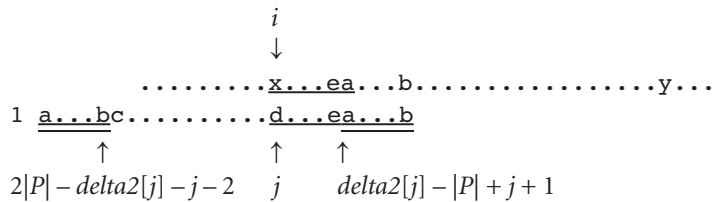


when suffix  $P(j + 1 \dots |P| - 1)$  equals to the substring  $P(|P| - \text{delta2}[j] \dots 2|P| - \text{delta2}[j] - j - 2)$  changes to:

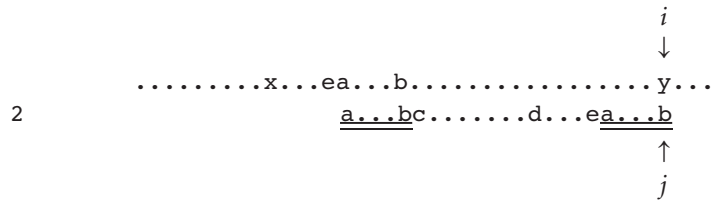


before resuming the matching process.

In the second case, the situation



when suffix  $P(\text{delta2}[j] - |P| + j + 1 \dots |P| - 1)$  equals the prefix  $P(0 \dots 2|P| - \text{delta2}[j] - j - 2)$  changes to:



Note that the inequalities in the *or* clauses in the definition of  $\text{delta2}$  are indispensable for the second case.

To compute  $\text{delta2}$ , a brute force algorithm can be used, as follows:

```

computeDelta2ByBruteForce(pattern P, table delta2)
  for k = 0 to |P|-1
    delta2[k] = 2*|P|-k-1;
  // partial suffix phase:
  for k = 0 to |P|-2 // k is a mismatch position;
    for (i = 0, s = j = k+1; j < |P|; s++, j = s, i = 0)
      while j < |P| and Pi == Pj
        i++;
        j++;
      if j == |P| // a suffix to the right of k is detected
        delta2[k] = |P|-(k+1) + |P|-i; // that is equal to a prefix of P,
        break; // P(0...i-1) equals P(|P|-i...|P|-1);
  // full suffix phase:
  for k = |P|-2 downto 0 // k is a mismatch position;
    for (i = |P|-1, s = j = |P|-2; j ≥ |P|-k-2; s--, j = s, i = |P|-1)
      if Pi == Pj
        while i > k and Pi == Pj
          i--;
          j--;
        if j == -1 or i == k and Pi ≠ Pj // a substring in P is detected
          delta2[k] = |P|-j-1; // that is equal to the suffix directly following k,
          break; // P(j+1...j + |P| - k - 1) equals P(k + 1...|P|-1);
  if P|P|-1 == P|P|-2
    delta2[|P|-1] = delta2[|P|-2];
  else delta2[|P|-1] = 1;

```

The algorithm has three phases: initialization, partial suffix phase, and full suffix phase. Initialization prepares the pattern for the longest shift; after a mismatch, the pattern is shifted all the way past the mismatched character. The only exception is the mismatch at the last character in  $P$ , after which  $P$  is shifted by only one position. The partial suffix phase looks for the longest suffixes after a mismatch point by matching prefixes. The full suffix phase updates those values in  $delta2$  that correspond to a mismatch being followed by a suffix that has a matching substring in  $P$ . For  $P = abdabcabcab$ , the values in  $delta2$  after each phase are as follows:

	a	b	d	a	b	c	a	b	c	a	b	
delta2 =	21	20	19	18	17	16	15	14	13	12	*	after initialization
delta2 =	19	18	17	16	15	14	13	12	11	12	*	after partial suffix phase
delta2 =	19	18	17	16	15	8	13	12	8	12	1	after full suffix phase

The algorithm can be applied to short patterns only, because it is quadratic in the best case and cubic in the worst case. For  $P = a^m$ , the full suffix phase executes in total,

$$\sum_{k=0}^{m-2} \sum_{j=m-k-2}^{m-2} (m-k) = \frac{(m-1)m(m+4)}{6}$$

comparisons, because in one iteration of the inner `for` loop,  $m-k-1$  comparisons are performed in the `while` loop and one in the `if` statement.  $P = a^{m-1}b$  is an exam-

ple of the worst case for the partial suffix phase. Clearly, for longer patterns a faster algorithm is needed.

The algorithm can be significantly improved by using an auxiliary table  $f$  that is a counterpart of  $next$  for the reverse of  $P$ . The table  $f$  is defined as follows:

$$f[j] = \begin{cases} |P| & \text{if } j = |P| - 1 \\ \min\{k; j < k < |P| - 1 \text{ and } P(j+1 \dots j+|P|-k) = P(k+1 \dots |P|-1)\} & \text{if } 0 \leq j < |P| - 1 \end{cases}$$

That is,  $f[j]$  is the position preceding the starting position of the longest suffix of  $P$  of length  $|P|-f[j]$  that is equal to the substring of  $P$  that begins at position  $j+1$ :

$$\begin{array}{ccccccc} & & & & f[j]+1 & & |P|-1 \\ & & & & \downarrow & & \downarrow \\ \dots & \underline{a} & \dots & \underline{bc} & \dots & \underline{da} & \dots & \underline{b} \\ & \uparrow & & \uparrow & & & & \\ & j+1 & & j+|P|-f[j] & & & & \end{array}$$

For example, for  $P = aaabaaaba$ ,  $f[0] = 4$ , because substring  $P(1 \dots 4) = aaba$  is the same as the suffix  $P(5 \dots 8)$ ;  $f[1] = 5$ , because substring  $P(2 \dots 4)$  is equal to the suffix  $P(6 \dots 8)$ ; that is, the underlined substrings in  $P = \underline{aa} \underline{ba} \underline{aa} \underline{ba}$  are equal. The entire table  $f = [4 \ 5 \ 6 \ 7 \ 7 \ 8 \ 8 \ 9]$ . Note that a substring of  $P$  equal to a suffix of  $P$  can overlap, as in  $P = baaabaaaba$ .

The table  $f$  allows us to go from a certain substring of  $P$  to a matching suffix of  $P$ . But the matching process during execution of the Boyer-Moore algorithm proceeds from right to left, so that after a mismatch is found, a suffix is known and we need to know a matching substring of  $P$  to align the substring with the suffix. In other words, we need to go from the suffix to the matching substring, which is the opposite direction with respect to information provided by  $f$ . That is why  $delta2$  is created to have direct access to the needed information. This can be accomplished with the following algorithm, which is obtained from `computeDelta2ByBruteForce()`.

```
computeDelta2UsingNext(pattern P, table delta2)
    findNext2(reverse(P), next);
    for i = 0 to |P|-1
        f[i] = |P| - next[|P|-i-1] - 1;
        delta2[i] = 2*|P| - i - 1;
    // full suffix phase:
    for i = 0 to |P|-2
        j = f[i];
        while j < |P|-1 and Pi ≠ Pj
            delta2[j] = |P| - i - 1;
            j = f[j];
    // partial suffix phase:
    for (i = 0; i < |P|-1 and P0 == Pf[i]; i = f[i])
        for j = i to f[i]-1
            if delta2[j] == 2*|P| - j - 1 // if not updated during full suffix phase,
                delta2[j] = delta2[j] - (|P| - f[i]); // update it now;
```

```

if P|P|-1 == P|P|-2
    delta2[|P|-1] = delta2[|P|-2];
else delta2[|P|-1] = 1;

```

First, table *next* is created and used to initialize table *f*. Also, table *delta2* is initialized to values that indicate shifting *P* past the mismatched character in *T*. For  $P = dabcbabeeabcab$  it is

	P	=	a	b	c	a	b	d	a	b	c	a	b	e	e	e	a	b	c	a	b
	f	=	14	15	16	17	18	13	14	15	16	17	18	18	18	16	17	18	18	18	19
	delta2	=	37	36	35	34	33	32	31	30	29	28	27	26	25	24	23	22	21	20	19

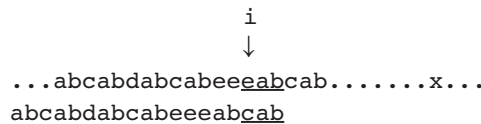
As in the brute force algorithm, the full suffix phase addresses the first case when a mismatched character  $P_j$  is directly followed by the suffix that is equal to a substring of *P* that begins anywhere to the left of  $P_j$ . In that phase, positions directly accessible from *f* are processed. For example, in the sixth iteration of the `for` loop,  $i = 5$  and  $f[5] = 13$ , which means that there is a suffix beginning at position 14, *abcab*, for which there is a substring beginning at position  $|P| - f[5] = 6$ , which is equal to the suffix. Because also  $P_5 \neq P_{13}$ , *delta2*[13] can be assigned a proper value:

			0				5					13					18				
	P	=	a	b	c	a	b	d	a	b	c	a	b	e	e	e	a	b	c	a	b
	f	=	14	15	16	17	18	13	14	15	16	17	18	18	18	16	17	18	18	18	19
	delta2	=	37	36	35	34	33	32	31	30	29	28	27	26	25	13	23	22	21	20	19

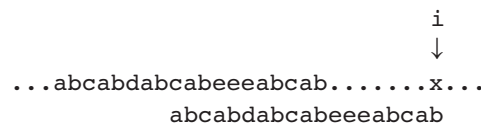
But the substring  $P(6 \dots 10) = abcab$  has a prefix *ab* that is the same as a suffix of the suffix *abcab*, and both the prefix *ab* and suffix *ab* are preceded by different characters. The position right before this shorter suffix is directly accessible only from the position  $f[13] = f[f[5]] = 16$  because  $i$  is still 5. Therefore, after the second iteration of the `while` loop—still during the sixth iteration of the `for` loop—the situation changes to

			0				5					13			16		18				
	P	=	a	b	c	a	b	d	a	b	c	a	b	e	e	e	a	b	c	a	b
	f	=	14	15	16	17	18	13	14	15	16	17	18	18	18	16	17	18	18	18	19
	delta2	=	37	36	35	34	33	32	31	30	29	28	27	26	25	13	23	22	13	20	19

Number 13 is put in cell *delta2*[16], which means that when the matching process stops at  $P_{16}$ , index  $i$  that scans *T* is incremented by 13; that is, when scanning stops after detecting a mismatch with  $P_{16}$ , the situation is as in



so that scanning is resumed after updating  $i$  as in



Note that the increment is the same as for the mismatch with  $P_{14}$ . This is because in both cases character  $T_{i+1} = a$  (before updating  $i$ ) is aligned with  $P_6$ , because both suffixes  $ab$  and  $abcab$  have a match that starts at  $P_6$ . However, as shown in the previous diagram, a match would be missed if  $i$  were incremented by 13. But the algorithm continues and for  $i = 13$  and  $j = f[13] = 16$  the `while` loop is entered to modify  $delta2$ :

```

          0                               13      16      18
P      = a b c a b d a b c a b e e e a b c a b
f      = 14 15 16 17 18 13 14 15 16 17 18 18 18 16 17 18 18 18 19
delta2 = 37 36 35 34 33 32 31 30 29 28 27 26 25 13 23 22  5 20 19

```

which prevents  $i$  from missing a match.

After finishing the first outer `for` loop, the second outer `for` loop is executed to decrease, if possible, other values in  $delta2$ . For  $i = 0$  the inner `for` loop is entered and executed for  $j$  from  $i = 0$  to  $f[0] - 1 = 13$ , so that  $delta2$  becomes

```

          0  1  2  3  4  5  6  7  8  9 10 11 12 13                               18
P      = a b c a b d a b c a b e e e a b c a b
f      = 14 15 16 17 18 13 14 15 16 17 18 18 18 16 17 18 18 18 19
delta2 = 32 31 30 29 28 27 26 25 24 23 22 21 20 13 23 22  5 20 19

```

In this way, the first 13 values in  $delta2$  are decremented by 5. This corresponds to the situation when a mismatch occurs for any of the first 13 characters in  $P$ . When this happens, the suffix  $abcab$  is aligned with the prefix  $abcab$  because the suffix is to the right of any of these positions.

In the second iteration of the outer loop, when  $i = 14$  and  $f[14] - 1 = 16$ , the inner loop updates  $delta2[14]$  and  $delta2[15]$  by decrementing them by 2 because this is the length of suffix  $ab$  to the right of  $P_{14}$  and  $P_{15}$  that have a matching prefix:

```

          0                               14 15 16      18
P      = a b c a b d a b c a b e e e a b c a b
f      = 14 15 16 17 18 13 14 15 16 17 18 18 18 16 17 18 18 18 19
delta2 = 32 31 30 29 28 27 26 25 24 23 22 21 20 13 21 20  5 20 19

```

After exiting the loops, the last value is changed so that finally the situation is

```

          0                               18
P      = a b c a b d a b c a b e e e a b c a b
f      = 14 15 16 17 18 13 14 15 16 17 18 18 18 16 17 18 18 18 19
delta2 = 32 31 30 29 28 27 26 25 24 23 22 21 20 13 21 20  5 20  1

```

To find the complexity of the algorithm we claim that the `while` loop is executed at most  $|P| - 1$  times in total. This is because after entering the `while` loop for an  $i$  and executing  $k$  iterations, the `while` loop is not entered for the next  $|P| - f[i] - 1$  iterations of the outer `for` loop, where  $|P| - f[i] - 1$  is the length of a matching suffix that begins at  $P_{f[i]+1}$  that matches the substring that begins at  $P_1$  and for which  $k \leq |P| - f[i] - 1$ . It is because for each character  $P_r$  in the substring  $P(i + 2 \dots i + |P| - f[i])$ ,  $P_r$  and the corresponding characters  $P_{r+f[i]}$  are preceded by the same character so that the condition in the `while` loop is false. Consider  $P = badaacadaa$  for which  $f = [5 6 7 8 9 8 9 8 9 10]$ . Iterations of the `while` loop can be activated either for  $P_0$  or for an  $s$  for

which  $f[s-1] > f[s]$  (e.g., for  $s = 5$ ,  $f[4] = 9$ , and  $f[5] = 8$ ). Increasing numbers in  $f$  indicate substrings that are extensions of following substrings and corresponding suffixes of  $P$ . For example, for  $f[1] = 6$  and  $f[2] = 7$ , numbers 1 and 6 indicate that the substring  $P(2 \dots 4)$  equals suffix  $P(7 \dots 9)$  and numbers 2 and 7 indicate that the substring  $P(3 \dots 4)$  equals suffix  $P(8 \dots 9)$ , that is,  $P(2 \dots 4)$  is an extension of  $P(3 \dots 4)$  and so is suffix  $P(7 \dots 9)$  a forward extension of suffix  $P(8 \dots 9)$ . This means that  $P_2 = P_7$ , and for  $j = 2$  the `while` loop cannot be entered.

In the worst case, the first half of  $P$  can lead to  $|P|/2$  iterations of the `while` loop followed by  $|P|/2$  iterations of the outer `for` loop without entering the `while` loop. Next, the first half of the second half of  $P$  can lead to  $|P|/4$  iterations of the `while` loop followed by the same number of iterations of the outer `for` loop without entering the `while` loop, and so on, which gives

$$\sum_{k=1}^{\lg|P|} \frac{|P|}{2^k} = |P| - 1$$

iterations of the `while` loop in total. Because the outer `for` loop can iterate  $|P| - 1$  times, this gives  $2(|P| - 1)$  as the maximum number of values assigned to  $j$ , and hence the complexity of the outer `for` loop.

The last nested `for` loop is executed at most  $|P| - 1$  times: For each  $i$ , it is executed for  $j$  from  $i$  to  $f[i] - 1$  and then  $i$  is updated to  $f[i]$ ; therefore,  $j$  refers to one position at most once. We can conclude that the algorithm is linear in the length of  $P$ .

To use *delta2*, algorithm `BoyerMooreSimple()` is modified by replacing the line that updates  $i$

```
else i = i + max(delta1[Ti], |P| - j);
```

with the line

```
else i = i + max(delta1[Ti], delta2[j]);
```

In an involved proof, Knuth shows that the Boyer-Moore algorithm that utilizes tables *delta1* and *delta2* performs at most  $7|T|$  comparisons if the text does not contain any occurrence of the pattern (Knuth, Morris, and Pratt, 1977). Guibas and Odlyzko (1980) improved the bound to  $4|T|$  and Cole (1994) improved it to  $3|T|$ .

### The Sunday Algorithms

Daniel Sunday (1990) begins his analyses with an observation that in the case of a mismatch with a text character  $T_i$ , the pattern shifts to the right by at least one position so that the character  $T_{i+|P|}$  is included in the next iteration. The Boyer-Moore algorithm shifts the pattern according to the value in the *delta1* table (we leave the table *delta2* aside, for now) and this table includes shifts with respect to the mismatched character  $T_i$ . It would be more advantageous, Sunday submits, to build *delta1* with respect to character  $T_{i+|P|}$ . In this way,  $delta1[ch]$  is the position of character  $ch$  in  $P$  counted from the left. This is closely related to Boyer-Moore's *delta1* because by incrementing by one the values in the latter, we obtain Sunday's *delta1*.

One advantage of this solution is that the set of three rules used in the Boyer-Moore algorithm can be simplified. The no occurrence rule is slightly modified: If the character  $T_{i+|P|}$  appears nowhere in  $P$ , align  $P_0$  with  $T_{i+|P|+1}$ . The right side occurrence rule is no longer needed because all characters in  $P$  are to the left of  $T_{i+|P|}$ . Finally, the left side occurrence rule can be simplified to the occurrence rule: If there is an occurrence in  $P$  of character  $ch$  equal to  $T_{i+|P|}$ , align  $T_{i+|P|}$  with the closest (the rightmost)  $ch$  in  $P$ .

Although the definition of *delta1* depends on right-to-left scan of pattern, the matching process can be performed in any order, not only left to right or right to left. Sunday's `quickSearch()` performs the scan left to right. Here is its pseudocode:

```
quickSearch(pattern P, text T)
    initialize all cells of delta1 to |P| + 1;
    for i = 0 to |P|-1
        delta1[Pi] = |P| + 1 - i;
    i = 0
    while i ≤ |T|-|P|
        j = 0;
        while j < |P| and i < |T| and Pj == Ti
            i++;
            j++;
        if j > |P|
            return success at i-|P|;
        i = i + delta1[Ti+|P|];
    return failure;
```

For example, for  $P = \text{cababa}$ ,  $\text{delta1}[\text{'a'}] = 1$ ,  $\text{delta1}[\text{'b'}] = 2$ ,  $\text{delta1}[\text{'c'}] = 6$ , and for remaining characters  $ch$ ,  $\text{delta1}[ch] = 7$ . Here is an example:

```
ffffaabcfacababafa
1  cababa
2   cababa
3    cababa
4     cababa
```

Line 1 has a mismatch right at the beginning, so that in line 2, character  $T_{i+|P|} = T_{0+6} = b$  is aligned with the rightmost  $b$  in  $P$  and  $i = 0$  is incremented by  $\text{delta1}[T_{i+|P|}] = \text{delta1}[\text{'b'}] = 2$ , so that  $i = 2$ . Again, there is a mismatch at the beginning of  $P$ ;  $i = 2$  is incremented by  $\text{delta1}[T_{i+|P|}] = \text{delta1}[\text{'f'}] = 6$ , so that  $i = 9$ ; that is, in effect,  $P$  is shifted past letter  $T_{i+|P|} = f$ . The fourth iteration is successful. Compare this trace with the trace for `BoyerMooreSimple()`, for which  $\text{delta1}[\text{'a'}] = 0$ ,  $\text{delta1}[\text{'b'}] = 1$ ,  $\text{delta1}[\text{'c'}] = 5$ , and for remaining characters  $ch$ ,  $\text{delta1}[ch] = 6$ :

```
ffffaabcfacababafa
1  cababa
2   cababa
3    cababa
4     cababa
5      cababa
6       cababa
```

Sunday introduces two more algorithms, both based on a generalized *delta2* table. Sunday's *delta2* may be the same as Knuth-Morris-Pratt's *next* table if the *delta2* table is initialized by scanning *P* left to right. If it is scanned in the reverse order, then *delta2* is the same as Boyer-Moore's *delta2*. However, the matching process can be done in any order. Sunday's second algorithm, the maximal shift algorithm, uses *delta2* such that *delta2*[0] is associated with a character in *P* whose next leftward occurrence in *P* is maximum; *delta2*[1] refers to a character in *P* for which the next leftward occurrence in *P* is not less than *delta2*[0], and so on. In the third algorithm, the optimal mismatch algorithm, characters are ordered in ascending order of frequency of occurrence. This is motivated by the fact that in English, 20 percent of words end with the letter *e* and 10 percent of the letters used in English are also *e*. Thus, it is very likely to match first characters tested by using Boyer-Moore's backward scanning. The testing of the least probable characters first improves the likelihood of early mismatch. However, Sunday's own tests show that although his three algorithms fare much better on searching for short English words than the Boyer-Moore algorithm, there is little difference between the three algorithms, and for all practical purposes `quickSearch()` is sufficient. This is particularly true when the overhead to find *delta2* is taken into account (see Pirklbauer, 1992). To address the problem of frequency of character occurrence, an adaptive technique can be used, as in Smith (1991).

Sunday points out that his *delta1* table usually allows for shifts one position greater than shifts based on Boyer-Moore's *delta1*. However, after pointing out that this is not always the case, Smith (1991) indicates that the larger of the two values should be used.

### 13.1.4 Multiple Searches

The algorithms presented in the preceding sections are designed to find an occurrence of a pattern in a text. Even if there are many occurrences, the algorithms are discontinued after finding the first. Many times, however, we are interested in finding all occurrences in the text. One way to accomplish this is to continue the search after an occurrence is detected, after shifting the pattern by one position. For example, the Boyer-Moore algorithm can be quickly modified to accommodate multiple searches in the following fashion:

```

BoyerMooreAllOccurrences(pattern P, text T)
    initialize all cells of delta1 to |P|;
    for i = 0 to |P| - 1
        delta1[Pi] = |P| - i - 1;
    compute delta2;
    i = |P| - 1;
    while i < |T|
        j = |P| - 1;
        while j ≥ 0 and Pj == Ti
            i--;
            j--;
        if j == -1
            output: match at i+1;

```



```

        i = i + |P| + 1; // shift P by one position to the right;
    else i = i + max(delta1[Ti], delta2[j]);

```

But consider the process of finding all occurrences of  $P = abababa$  in  $T = ababababa \dots$ :

```

abababababa...
1 abababa
2  abababa
3  abababa
4   abababa

```

In every second iteration, the entire pattern is compared to the text only after shifting by two positions. For this reason, the algorithm requires  $|P|(|T| - |P| + 1)/2$ , or more generally,  $O(|T||P|)$  steps. To reduce the number of comparisons it should be recognized that the pattern includes consecutive repetitive substrings, called *periods*, which should not be reexamined after they were matched with substrings in the text with which they are about to be matched.

The Boyer-Moore-Galil algorithm works the same as the Boyer-Moore algorithm until the first occurrence of the pattern is detected (Galil, 1979). After that, the pattern is shifted by  $p = |\text{the period of the pattern}|$ , and only the last  $p$  characters of the pattern need to be compared to the corresponding characters in the text to know whether the entire pattern matches a substring in the text. In this way, the part overlapping a previous occurrence does not have to be rechecked. For example, for  $P = abababa$  with the period  $ab$ , the new algorithm is executed as follows:

```

abababababa...
1 abababa
2  abababa
3   abababa

```

However, if a mismatch is found, then the Boyer-Moore-Galil algorithm resumes its executions in the same way as the Boyer-Moore algorithm. The algorithm is as follows:

```

BoyerMooreGalil(pattern P, text T)
    p = period(P);
    compute delta1 and delta2;
    skip = -1;
    i = |P|-1;
    while i < |T|
        j = |P|-1;
        while j > skip and Pj == Ti
            i--;
            j--;
        if j == skip
            output: a match at i-skip;
            if p == 0
                i = i + |P|+1;
            else if skip == -1
                i = i + |P|+p;
            else i = i + 2*p;

```

```

        skip = |P|-p-1;
    else skip = -1;
        i = i + max(delta1[Ti], delta2[j]);

```

It is clear that the algorithm achieves better performance only for patterns with periods and only if the text contains a high number of overlapping occurrences of the pattern. For patterns with no periods, the two algorithms work the same way. For a pattern with periods but with no overlapping occurrence, the Boyer-Moore-Galil algorithm performs better shifts than the Boyer-Moore algorithm, but only when an occurrence is found.

### 13.1.5 Bit-Oriented Approach

In this approach, each state of the search is represented as a number—that is, a string of bits—and a transition from one state to the next is the result of a small number of bitwise operations. A shift-and algorithm that uses a bit-oriented approach for string matching was proposed by Baeza-Yates and Gonnet (1992) (see also Wu and Manber, 1992).

Consider a  $(|P| + 1) \times (|T| + 1)$  table of bits defined as follows:

$$state[j,i] = \begin{cases} 0 & \text{if } i = -1 \text{ and } j > -1 \\ 1 & \text{if } j = -1 \\ 1 & \text{if } state[j-1, i-1] = 1 \text{ and } P_j = T_i \\ 0 & \text{otherwise} \end{cases}$$

The table includes information concerning all matches between prefixes of  $P$  and substrings ending at particular positions of the text. Number 1s in a row  $j$  of the table indicate the ending positions in  $T$  of substrings  $T(i-j \dots i)$  matching prefix  $P(0 \dots j)$  and number 1s in a column  $i$  indicate the prefixes of  $P$  that match substrings ending at  $i$  in  $T$ . For  $P = ababac$  and  $T = bbababacaaba$ ,  $state[0,4] = state[2,4] = 1$  because position 4 of  $T$  is the ending position of matches for prefixes  $P(0 \dots 0) = a$  and  $P(0 \dots 2) = aba$ . Number 1 in the last row indicates an occurrence of the entire pattern  $P$  in  $T$ .

The algorithm computes a new state from the previous state, however, which can be done very efficiently without maintaining the entire table  $state$ . To accomplish it, a two-dimensional bit table is used to indicate for each character of the alphabet the positions at which it occurs in the pattern:

$$charactersInP[j,ch] = \begin{cases} 1 & \text{if } ch = P_j \\ 0 & \text{otherwise} \end{cases}$$

For example, the letter  $a$  occurs at positions 0, 2, and 4 of the pattern  $P = ababac$ ; therefore,  $charactersInP[0,'a'] = charactersInP[2,'a'] = charactersInP[4,'a'] = 1$  and  $charactersInP[1,'a'] = charactersInP[3,'a'] = charactersInP[5,'a'] = 0$ . In practice,  $charactersInP$  is a one-dimensional table of numbers where bit positions in the number are implicitly used for row indices. Also, the table can only include information about the characters that appear in  $P$ . The tables  $state$  and  $charactersInP$  for  $P = ababac$  and  $T = bbababacaaba$  are as follows:



a substring ending at position 5 of  $T$ , and now we are about to check whether the longer prefix  $aba$  matches a substring of  $T$  ending at 6. Because the last letter of this prefix,  $a$ , is the same as  $T_6$ , the tentative match becomes permanent. But consider the processing of  $T_7$ . The prefixes  $a$ ,  $aba$ , and  $ababa$  are extended to become  $ab$ ,  $abab$ , and  $ababac$ , and then the last characters are indirectly (with bitwise-and) compared with  $T_7 = c$ . Out of three extended prefixes, only one is retained, and because this prefix is equal to the pattern itself, an occurrence of  $P$  is reported.

The transition from state 6 to 7 is summarized as follows: first, the shift operation is executed:

		6		
		b		
		1	1	
		0	1	
shiftBits	1	⇒	0	
		0	1	
		1	0	
		0	1	

and then the bitwise-and generates state 7:

			7	
		c	c	
1		0	0	
1		0	0	
0	bitwise-and	0	⇒	0
1		0	0	
0		0	0	
1		1	1	

A pseudocode of the algorithm is quite simple:

```

shiftAnd(pattern P, text T)
    state = 0;
    matchBit = 1;
    // initialization:
    for i = 1 to |P|-1
        matchBit <<= 1;
    for i = 0 to 255
        charactersInP[i] = 0;
    for (i = 0, j = 1; i < |P|; i++, j <<= 1)
        charactersInP[Pi] |= j;
    // matching process:
    for i = 0 to |T|-1
        state = ((state << 1) | 1) & charactersInP[Ti];
        if ((matchBit & state) != 0)
            output: a match at i-|P|+1;

```

The two-dimensional table *charactersInP* is implemented as a one-dimensional table of long integers, where the second dimension is indicated by positions of bits in

the integers. The function *shiftBits* is implemented as left shift followed by bitwise-or of the result of the shift and number 1. In this way, number 1 is placed in the least significant (rightmost) bit position. The algorithm performs  $|T|$  iterations in the matching phase, executing four bitwise operations in each iteration, an assignment, and a comparison.

The algorithm requires no buffering of text as is the case for the Boyer-Moore algorithm. It is also clear that the length of the pattern must not exceed the size of an integer, which for many practical purposes is adequate. However, this limitation can be lifted by using a dynamic version of the shift-and algorithm. Here is one possible implementation of such a version:

```
dynamicShiftAnd(pattern P, text T)
  cellLen = size of long integer in bits;
  lastBit = 1;
  matchBit = 1;
  cellNum = (|P| % 8 == 0) ? (|P|/8) : (|P|/8 + 1);
  matchBit = 1;
  // initialization:
  for i = 1 to |P| - cellLen*(cellNum-1)-1
    matchBit <<= 1;
  for k = 0 to cellNum-1
    for i = 0 255
      charactersInP[k,i] = 0;
    for (i = k*cellLen, j = 1; i < (k+1)*cellLen && i < |P|; i++, j <<= 1)
      charactersInP[k,Pi] |= j;
  // matching process:
  for j = cellNum-1 down to 0
    state[j] = 0;
  for i = 0 to |T|-1
    for (j = cellNum-1 down to 1
      firstBit = ((state[j-1] & lastBit) == 0) ? 0 : 1;
      state[j] = ((state[j] << 1) | firstBit) & charactersInP[j,Ti];
    state[0] = ((state[0] << 1) | 1) & charactersInP[0,Ti];
    if ((matchBit & state[cellNum-1]) != 0)
      output: a match at i-|P|+1;
```

The table *charactersInP*, as before, records the occurrences of characters in the pattern, but in a piecemeal fashion. For example, for a pattern  $P$  of length 80 and 64-bit long integers, *charactersInP*[0] records character occurrences for subpattern  $P(0 \dots 63)$  and *charactersInP*[1] for  $P(64 \dots 79)$ . The table *state* still implements one state of the matching process. For example, *state*[0] represents the state for  $P(0 \dots 63)$  and *state*[1] represents the state for  $P(64 \dots 79)$ . Shifting bits consists of shifting bits to the right neighbor cell and shifting in bits from left neighbors, if any. For example, the last bit shifted out from *state*[0] is shifted in as the first bit to *state*[1]

The dynamic algorithm is not linear for all the lengths, but it is linear in intervals marked by the long integer size. For example, for a 64-bit word, patterns of length 1 through 64 require  $O(|T|)$  operations; patterns of length 65 through 128 require  $O(2|T|)$  operations and, generally,  $O(\lceil |P|/64 \rceil |T|)$  operations.

### 13.1.6 Matching Sets of Words

The problem of matching sets of words arises in the situation when for a set  $keywords = \{s_0, \dots, s_{k-1}\}$  of strings and a text  $T$ , we need to identify in  $T$  all substrings that match strings in  $keywords$ . It is possible that the substrings overlap one another. In a brute force approach, the matching process is executed for each word in the set  $keywords$  separately. The running time of such an approach is  $O(|keywords||T|)$ . However, it is possible to considerably improve the run time by considering all relevant words at the same time during the matching process. An algorithm performing such matching was proposed by Aho and Corasick (1975).

Aho and Corasick construct a string-matching automaton that is composed of a set of states represented by numbers, an initial state 0, an alphabet, and two functions: a goto function  $g$  that assigns to each pair (state, character) a state or a special label *fail*, and a failure function  $f$  that assigns a state to a state. Also, the algorithm uses an output function  $output$ , which associates a set of keywords with each state. The states, for which a set of keywords is not empty, are accepting states. After reaching an accepting state, a set of keywords associated with it is output.

Two types of transitions from one state to another are made during execution of the algorithm: goto transitions and failure transitions. The automaton makes a failure transition, when for the current *state* and character  $T_i$ ,  $g(state, T_i) = fail$ , in which case, the failure function  $f$  is used to determine the next current *state* =  $f(state)$ . If  $g(state, T_i) = state_1 \neq fail$ , then  $state_1$  becomes the current state,  $T_{i+1}$  becomes the current character, and the transition from  $state_1$  to  $g(state_1, T_{i+1})$  is tried.

For no character  $ch$ ,  $g(0, ch) = fail$ ; that is, no failure transitions occur in the initial state. In this way, one character from  $T$  can be processed in each iteration of the algorithm. The algorithm is summarized as follows:

```
AhoCorasick(set keywords, text T)
  computeGotoFunction(keywords, g, output); // the output function is computed
  computeFailureFunction(g, output, f); // in these two functions;
  state = 0;
  for i = 0 to |T| - 1
    while g(state, Ti) == fail
      state = f(state);
    state = g(state, Ti);
    if output(state) is not empty
      output: a match ending at i;
      output(state);
```

The goto function is constructed in the form of a trie with numbered nodes representing states and the root representing the start state,  $state_0$ . A trie, as discussed in Section 7.2, is a multiway tree in which consecutive characters of a string are used to navigate the search in the tree. To enable such a search, links in the trie can be labeled with characters. When descending down a particular path and concatenating the characters encountered along the way, a word corresponding to this path is constructed. To make it possible, the insertion process has to construct such paths. Consider the construction of a trie for the set  $keywords = \{inner, input, in, outer, output, out, put, outing, tint\}$  (Figure 13.1). After inserting the word *inner*, there is only one



The last step is adding a loop in the root; that is, a one-branch-long path from the root to the root, for all characters other than the characters for which there are branches coming out of the root, in this case characters *i*, *o*, *p*, and *t*. An algorithm to construct the goto function is as follows:

```
computeGotoFunction(set keywords, function g, function output)
  newstate = 0;
  for i = 0 to |keywords| - 1
    state = 0;
    j = 0;
    P = keyword[i];
    while g(state, Pj) ≠ fail // descend down an existing path;
      state = g(state, Pj);
      j++;
    for p = j to |P| - 1 // create a path for suffix P(j...|P|);
      newstate++;
      g(state, Pp) = newstate;
      state = newstate;
    add P to the set output(state);
  for all characters ch of the alphabet // create loops in state 0;
    if g(0, ch) == fail
      g(0, ch) = 0;
```

Note that it is now impossible to tell which words are included in the trie. Is the word *inn* in the trie? There exists a path corresponding to it, but the word should not be counted as a part of the trie. To handle the problem of words whose paths are entirely included in other paths—that is, words, that are prefixes of other words—a special symbol can be used as a marker of the end of each word and included in the trie only when ambiguity may arise. Another solution is to include a flag as a part of each node to indicate the end of a word. The Aho-Corasick algorithm solves this problem with the output function, although this is not the only role played by this function.

The first stage of constructing the output function is included in `computeGotoFunction()`. For each state *s* (node of the trie), the output function tells whether there are paths that begin anywhere between the start state and *s* that correspond to words in the set *keywords*. After `computeGotoFunction()` is finished, the output function establishes the following mapping between states and keywords (states not indicated correspond to an empty set of words):

2 { <i>in</i> }	5 { <i>inner</i> }	8 { <i>input</i> }
11 { <i>out</i> }	13 { <i>outer</i> }	16 { <i>output</i> }
19 { <i>put</i> }	22 { <i>outing</i> }	26 { <i>tint</i> }

At this stage, the output function finds for each state *s* a word in *keywords* that corresponds to the path that begins at the start state and ends at *s*. At that moment, the output function plays the role of a flag, indicating for each node of the trie whether it corresponds to a keyword.

The goto function is now used to construct the failure function during a breadth-first trie traversal; that is, when traversing the trie level by level. For each node, the



function records the fact that a suffix of the string ending in a particular node is also a prefix of a word that begins in the root, if any. In this, the failure function is a generalization of the table *next* used by the Knuth-Morris-Pratt algorithm, and it determines from which state the matching process should be resumed if a mismatch occurs. Consider the matching process executed as in the Knuth-Morris-Pratt algorithm with character comparison:

```

      i
      ↓
...outinput...
1   outing
2a  inner
2b  input
2c  tint

```

After a mismatch in position  $i$ , the matching process should resume from the same character  $T_i$  and a character in any of the keywords that follows a prefix equal to any of the suffixes in the substrings that end before the mismatched position in the pattern. In our example, the suffix *in* of the partially matched pattern *outin* is the same as a prefix of two keywords, *inner* and *input*, and the suffix *tin* of *outin* corresponds to a prefix of *tint*. As in the Knuth-Morris-Pratt algorithm, we do not want to repeat the comparisons already made, so the matching process is resumed from the mismatched character  $T_i$ , and the characters in the three keywords that follow the matched prefixes. But unlike in the Knuth-Morris-Pratt method, three patterns (keywords) have to be taken into account at the same time. How can the mismatched character  $T_i$  be compared at the same time to three different characters,  $n$ ,  $p$ , and  $t$ , in the three candidate keywords for a possible match? They are not compared at all. Instead of comparing characters between the text and keywords, the current character in the text is used to choose a transition in the trie, whereby some of the candidate keywords can be eliminated. After the matching process continues in round 2, three keywords are eliminated and the situation is as in

```

      i
      ↓
...outinput...
2b  input

```

But how can candidate keywords be chosen for the next round? This is precisely the role of the failure function. The function adds to the trie the failure transitions. A failure transition is made if the matching process reaches a particular node (state) and there is no branch coming out of the node that corresponds to the current text character. In other words, the failure transition is made when a mismatch occurs between the current text character and each character accessible from the current node. Figure 13.1d shows the failure links corresponding to the failure function, which is:

state	1	2	3	4	5	6	7	8	9	10	11	12	13	14	15	16	17	18	19	20	21	22	23	24	25	26
f(state)	0	0	0	0	0	17	18	19	0	0	23	0	0	17	18	19	0	0	23	24	25	0	0	1	2	23

A failure transition exists for each state except for the start state. The transitions to the start state are not shown. With this function, a part of the matching process indicated in the previous two diagrams—an attempt to match *outing* in round 1 and then three keywords in round 2—corresponds to scanning the trie along the path shown in Figure 13.1e. Each nonfailure transition means descending the trie down a path. After reaching node 21, a mismatch occurs (the text character *p* mismatches the only character reachable from this node, *g*), and the failure transition leads to node 25 and, indirectly (through a failure transition from node 25), to node 2. This means that the words associated with paths on which nodes 25 and 2 are located are candidates for matches. The current text letter *p* mismatches the letter *t* accessible from node 25; therefore, the next failure transition is made, from node 25 to node 2, which eventually leads to a successful match.

Here is an algorithm to construct the failure function:

```
computeFailureFunction(function g, function output, function f)
  for each character ch of the alphabet
    if g(0,ch) ≠ 0
      enqueue(g(0,ch));
      f(g(0,ch)) = 0;
  while queue is not empty
    dequeue state r;
    for each character ch of the alphabet
      if g(r,ch) ≠ fail
        enqueue(g(r,ch));
        state = f(r);
        while g(state,ch) == fail // follow failure links for
          state = f(state); // character ch;
        f(g(r,ch)) = g(state,ch);
        include in output(s) keywords from output(f(g(r,ch)));
```

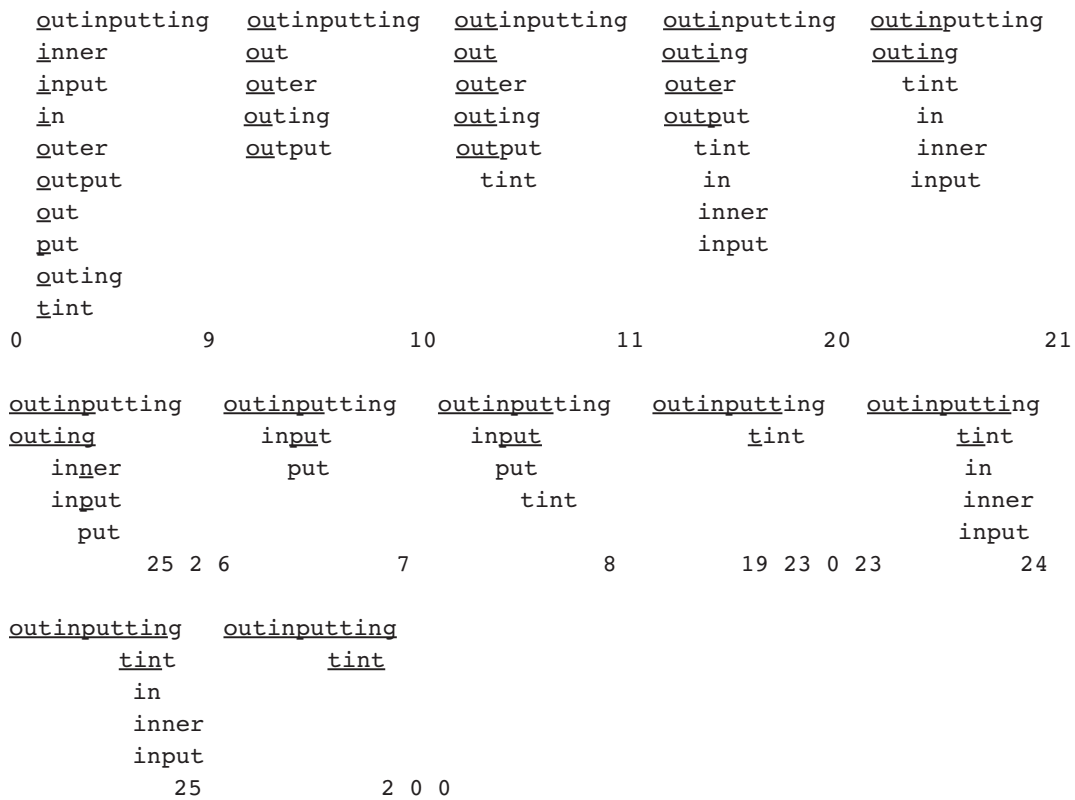
For each *state* accessible through character *ch* from a dequeued state *r*, the algorithm adds a failure link. It follows failure links for *ch* until it finds a nonfailure (goto) transition for it. For example, when processing *state* 12 accessible through letter *e* from state *r* = 11, there is a failure transition for *e* from 11 to 0 and a nonfailure link for *e* from 0 to 0; therefore,  $f(12) = 0$  (Figure 13.1d). For *state* 20 accessible from the same *state* 11 through letter *i*, there is a nonfailure transition from 11 for *i*; therefore, the inner `while` loop is not entered and  $f(20) = 24$ . The `while` loop iterates twice when determining the failure transition for *state* 22 accessible from state *r* = 21 through letter *g*; the first failure link for *g* leads from 21 to 25, then from 25 to 2, and finally from 2 to 0, where there is a nonfailure link for *g* to the same state 0.

The algorithm also completes the construction of the output function. For each node, the output function records words that end in this node, although they do not have to begin in the root. In the process of creating the output function during the breadth-first traversal, a list of words associated with the current node is expanded by adding words associated with a node reachable through the failure link. The first list expanded in this way is the empty list corresponding to node 25 on level 4 by including the word from the list *{in}* corresponding to node 2 and created when exe-

cuting `computeGotoFunction()`. The next list expanded in this process is the list `{input}` associated with node 8 on level 6 by including the list `{put}` associated with node 19 accessible from node 8 through a failure link. In effect, the number of non-empty lists is expanded and some of the existing lists are extended by adding new keywords:

2 {in}	5 {inner}	8 {put, input}
11 {out}	13 {outer}	16 {put, output}
19 {put}	21 {in}	22 {outing}
25 {in}	26 {tint}	

In this way, every time a matching process reaches a node in the trie that is associated with a nonempty list of keywords, all the keywords can be output as matching a substring of text ending in the current text position *i*. For example, for text `outinputting` and `keywords = {inner, input, in, outer, output, out, put, outing, tint}`, the steps executed by `AhoCorasick()` are as follows:



The numbers indicate states. For example, the initial *o* leads from state 0 to state 9, and letter *p* leads from state 21 to state 25 through a failure link, then to state 2, also through a failure link, and then to state 6. Underlined are letters of the words that are on the path chosen by the algorithm or letters that are at the links branching out from the current state. Words not underlined are the ones that can be reached indirectly through the output function or through failure links.

The algorithm produces the following output:

```
a match ending at 2: out
a match ending at 4: in
a match ending at 7: put input
a match ending at 10: in
```

The goto function can be implemented as a two-dimensional array of size (number of states) · (number of characters). This implementation allows for an immediate access of the value corresponding to a pair (*state, ch*); however, the array would be very sparsely populated with nonfailure transitions. Therefore, a one-dimensional array of array lists or linked lists can be used instead: an array of linked lists (array lists) of characters indexed with the state numbers or an array indexed with characters of linked lists (array lists) of states (or state numbers) (see Section 3.6).

The failure function can be implemented as a one-dimensional array indexed with state numbers of states.

The output function can be implemented as an array of linked lists (or array lists) or words.

For the set  $keywords = \{s_0, \dots, s_{k-1}\}$  and the total length of keywords  $m = |s_0| + \dots + |s_{k-1}|$ , the algorithm `computeGotoFunction()` is executed in linear time  $O(m)$ , and the algorithm `computeFailureFunction()` can be executed in the same time.

To determine the complexity of `AhoCorasick()`, note that in one iteration of the for loop for *state* on level *l*, the while loop is executed at most  $l - 1$  times, which means that at most  $l - 1$  failure transitions can be made for *state* corresponding to a node on level *l*, because these transitions always go up the trie by at least one level root. Therefore, the total number of failure transitions can be at most  $|T| - 1$ , and because the goto transitions go down the trie by exactly one level so that the number of goto transitions is exactly  $|T|$ , the number of state transitions during the entire matching process is  $O(2|T|)$ . Therefore, the complexity of the Aho-Corasick algorithm, including the creation of the failure and goto functions, is  $O(|T| + m)$ .

It is worth mentioning that the UNIX system's command *fgrep* is an implementation of Aho-Corasick.

### 13.1.7 Regular Expression Matching

In this section we address the problem of finding in text matches that are specified not by single or multiple patterns, but by regular expressions.

Regular expressions are defined as follows:

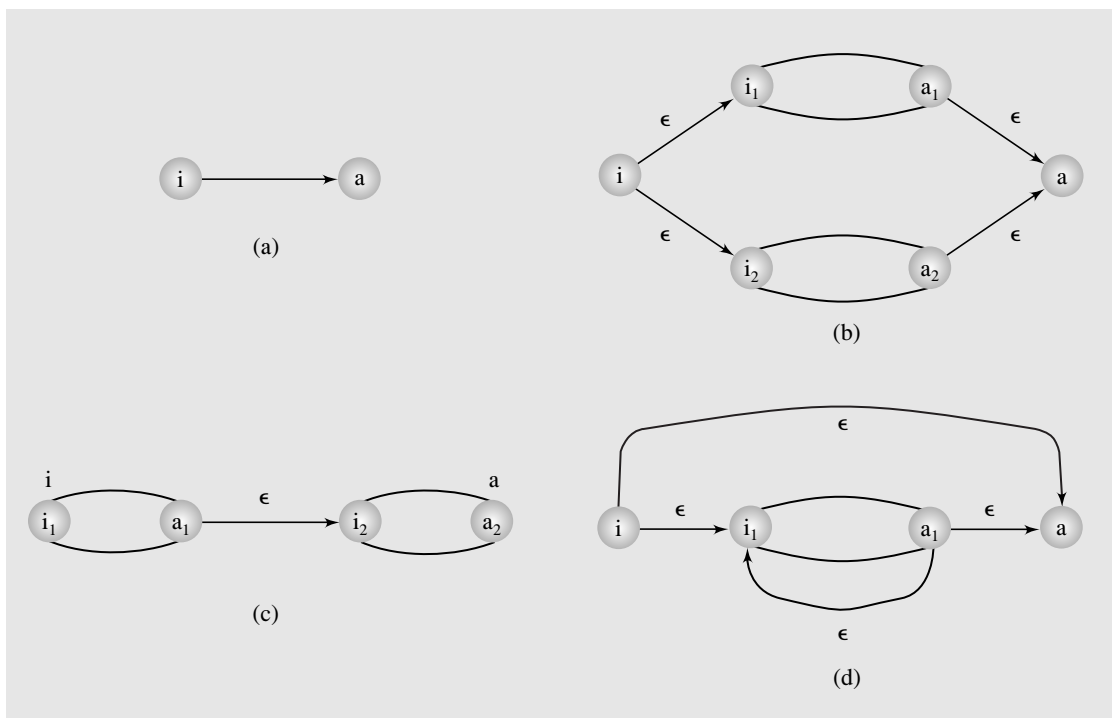
1. All letters of the alphabet are regular expressions.
2. If *r* and *s* are regular expressions, then  $r|s$ ,  $(r)$ ,  $r^*$ , and  $rs$  are regular expressions.
  - a. Regular expression  $r|s$  represents regular expression *r* or *s*.
  - b. Regular expression  $r^*$  (where the star is called a Kleene closure) represents any finite sequence of *rs*:  $r, rr, rrr, \dots$
  - c. Regular expression  $rs$  represents a concatenation *rs*.
  - d.  $(r)$  represents regular expression *r*.

An algorithm created by Ken Thompson constructs a nondeterministic finite automaton (NFA) corresponding to a regular expression. An NFA is a directed graph in which each node represents a state and each edge is labeled by a letter or a symbol  $\epsilon$  that represents an empty string. The automaton has one initial state and may have multiple terminal or accepting states, but in the context of this section it has only one accepting state. An NFA is used during the matching process. A match in the text is found if there is a path with letters on the edges in NFA from the initial state to an accepting state that matches a substring of the text.

A construction of an NFA is given in the form of the following recursive procedure:

1. An automaton representing one letter has one initial state  $i$ , one accepting state  $a$ , and an edge from the former to the latter labeled with the letter (Figure 13.2a).

**FIGURE 13.2** (a) An automaton representing one letter  $c$ ; an automaton a regular expression (b)  $rls$ , (c)  $rs$ , (d)  $r^*$ .



2. An automaton representing a regular expression  $r|s$  is a union of the automata representing  $r$  and  $s$ . The union is constructed by
  - a. creating an initial state  $i$  with two outgoing  $\epsilon$ -edges, one to the initial state  $i_1$  of the automaton representing  $r$  and one to the initial state  $i_2$  of the automaton representing  $s$ ;
  - b. creating an accepting state with two incoming  $\epsilon$ -edges from accepting states  $a_1$  and  $a_2$  of the two automata (Figure 13.2b).

3. An automaton representing a regular expression  $rs$  is a concatenation of the automata representing  $r$  and  $s$ . The concatenation is constructed by creating an  $\epsilon$ -edge from the accepting state  $a_1$  of the automaton representing  $r$  to the initial state  $i_2$  of the automaton representing  $s$ ; the initial state  $i_1$  becomes the initial state of the concatenated automaton, and  $a_2$  becomes its accepting state (Figure 13.2c).
4. An automaton representing a regular expression  $r^*$  is constructed as follows.
  - a. A new initial state  $i$  is created with an  $\epsilon$ -edge to the initial state  $i_1$  of the automaton representing  $r$ ;
  - b. a new accepting state  $a$  is added with an  $\epsilon$ -edge from the state  $a_1$ ;
  - c. an  $\epsilon$ -edge is added from the initial state  $i$  to the accepting state  $a$ ; and
  - d. an  $\epsilon$ -edge is added from the state  $a_1$  to the state  $i_1$  (Figure 13.2d).
5. An automaton representing a regular expression  $(r)$  is the same as the automaton representing  $r$ . The construction process indicates that an automaton corresponding to a regular expression
  - a. has one initial state and one accepting state;
  - b. each state has one outgoing edge labeled by a letter, one  $\epsilon$ -edge, or two  $\epsilon$ -edges;
  - c. in each step two new nodes can be created (or none), so the number of states in the automaton is at most twice the length of the regular expression to which it corresponds, and the number of edges is at most four times that size.

An automaton can be created with the following routines:

```

component()
    if regExpri is a letter
        p = a character automaton as in Figure 13.2a;
        i++;
    else if regExpri == '('
        i++;
        p = regularExpr();
        if regExpri != ')'
            failure;
        i++;
    if regExpri == '*'
        while regExpr++i == '*';
        p = a star automaton as in Figure 13.2d;
    return p;

concatenation()
    p1 = component();
    while regExpri is a letter or '('
        p2 = component();
        p1 = concatenation of automata as in Figure 13.2c;
    return p1;

```

```

regularExpr() {
    p1 = concatenation();
    while i < |T| and regExpri == '|'
        i++;
    p2 = concatenation();
    p1 = union of automata as in Figure 13.2b;
    return p1;
}

```

and the processing begins by calling first `regularExpr()`. Note that the processing is done very much in the same spirit as the interpreter presented in Section 5.11, where `regularExpr()` corresponds to `expression()`, `concatenation()` corresponds to `term()`, and `component()` corresponds to `factor()`.

Two sets are needed to properly process regular expression. The set  $\epsilon\text{psilon}(S)$  is a set of states accessible from the states in  $S$  through  $\epsilon$ -paths. The set  $\text{goto}(S, ch)$  is a set of states for which there is an edge labeled with character  $ch$  from a state in  $S$ . The sets can be created with the following algorithms:

```

gotoFunction(states, ch)
    for each state in states
        if there is a ch-transition from state to a state s
            include s in states2 if it is not already included;
    return states2;

epsilon(states)
    for each state in states
        remove state from states
        for each state s for which there is an  $\epsilon$ -edge from state to s
            include s in states and in states2 if it is not already included;
    return states2;

```

The automaton and the sets so constructed are now used to process a text and detect the longest matching regular expressions in a text and print their positions in the text. The algorithm is as follows:

```

Thompson(regExpr, text T)
    initState = parse();
    from = 1;
    states = epsilon({initState});
    for i = 0 to |T|-1
        states = gotoFunction(states, Ti);
        if states is empty
            states = gotoFunction({initState});
            from = i;
        if accepting state is in states
            output: "match from " from "to " i;
        states = epsilon(states);
        if accepting state is in states
            output: "match from " from "to " i;

```

```

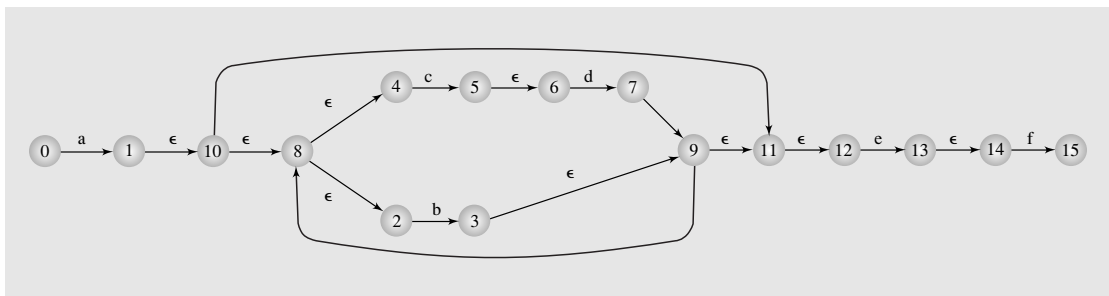
if states is empty
    states = epsilon({initState});
    from = i+1;

```

The following table shows the steps in processing the string  $T = aabbcd\text{eff}ae\text{fc}$  and regular expression  $\text{regExpr} = a(b|cd)^*ef$  with initialization  $\text{states} = \text{epsilon}(\{\text{initState}\}) = \{1\}$ . The automaton for the expression is given in Figure 13.3 with the number representing the order in which the states were generated. The substrings in the second column in boldface indicate the substrings detected by the program as matching  $\text{regExpr}$ ; they are substrings  $T(0 \dots 6) = \text{aabbcd}$  and  $T(8 \dots 10) = \text{ae}$ .

<i>i</i>	<i>ch</i>	<i>goto</i> (states, <i>ch</i> )	<i>states</i> after if-stmt	<i>epsilon</i> (states, <i>ch</i> )	<i>states</i> after if-stmt
0	<b>a</b>	{}	{1}	{2 4 8 10 11 12}	{2 4 8 10 11 12}
1	<b>a</b>	{}	{1}	{2 4 8 10 11 12}	{2 4 8 10 11 12}
2	<b>b</b>	{3}	{3}	{2 4 8 9 11 12}	{2 4 8 9 11 12}
3	<b>b</b>	{3}	{3}	{2 4 8 9 11 12}	{2 4 8 9 11 12}
4	<b>c</b>	{5}	{5}	{6}	{6}
5	<b>d</b>	{7}	{7}	{2 4 8 9 11 12}	{2 4 8 9 11 12}
6	<b>e</b>	{13}	{13}	{14}	{14}
7	<b>f</b>	{15}	{15}	{}	{1}
8	<b>f</b>	{}	{1}	{2 4 8 10 11 12}	{2 4 8 10 11 12}
9	<b>a</b>	{}	{1}	{2 4 8 10 11 12}	{2 4 8 10 11 12}
10	<b>e</b>	{13}	{13}	{14}	{14}
11	<b>f</b>	{15}	{15}	{}	{1}
12	<b>c</b>	{}	{1}	{}	{1}

**FIGURE 13.3** The Thompson automaton for the regular expression  $a(b|cd)^*ef$ .



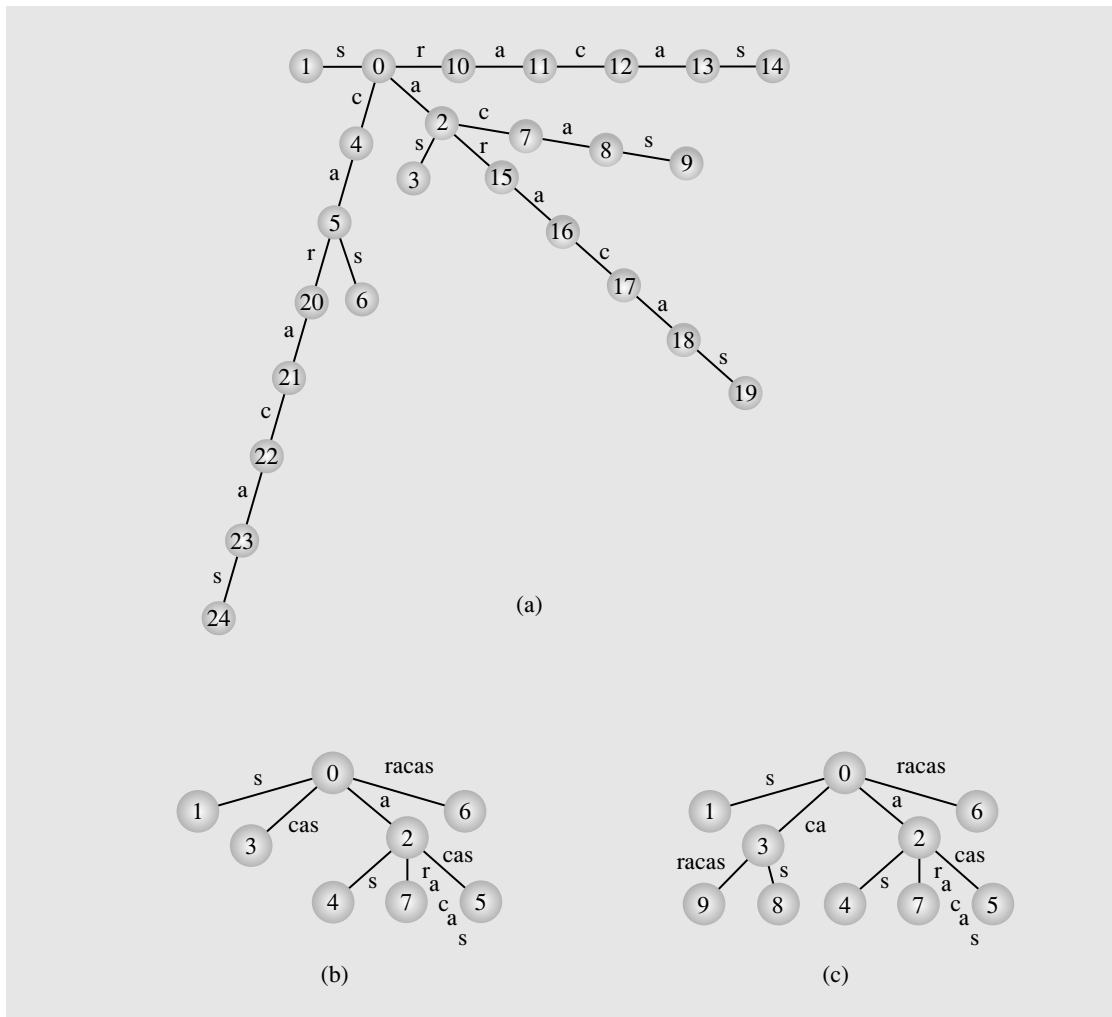
### 13.1.8 Suffix Tries and Trees

In many situations it is beneficial to preprocess a string or strings by creating a structure that allows further processing to be executed more efficiently than without using this structure. One such structure is a suffix trie and its generalization, a suffix tree.



A *suffix trie* for a text  $T$  is a tree structure in which each edge is labeled with one letter of  $T$  and each suffix of  $T$  is represented in the trie as a concatenation of edge labels from the root to some node of the trie. In a suffix trie,  $head(i)$  is the longest prefix of string  $T(i \dots |T| - 1)$  that matches a prefix of a suffix  $T(j \dots |T| - 1)$  that is already in the tree. A trie for the word *caracas* is in Figure 13.4a. It should be clear that in the worst case, when all letters are different, a trie requires one node for the root and  $|T| - i$  nodes for each suffix, where  $i$  is its starting position—that is,  $(|T| + 1)|T|/2$  in total—which means that the space requirement for a suffix trie is quadratic.

**FIGURE 13.4** (a) A suffix trie for the string *caracas*; (b) a suffix tree for the substring *caraca* and (c) for the string *caracas*.



A simple algorithm for creating a suffix trie for a text  $T$  simply looks at one suffix at a time and extends paths corresponding to the suffix when necessary:

```
bruteForceSuffixTrie(text T) {
    // the order of processing suffixes does not matter; it can be
    // from the largest to the smallest:
    // for i = 0 to |T|-1
    // or from the smallest to the largest:
    for i = |T|-1 downto 0
        node = root;
        j = i; // to represent the suffix T(i...|T| - 1);
        while Tj-edge from node exists
            node = the node accessible through Tj-edge from node;
            j++;
        // store the suffix T(j...|T| - 1) of the suffix T(i...|T| - 1) in the trie:
        for k = j to |T|-1
            create newNode;
            create edge(node, newNode, Tk);
            node = newNode;
```

The trie in Figure 13.4a has been created with this algorithm, which is reflected in the node numbers that indicate the order in which nodes were included in the trie.

The run time of the algorithm is quadratic because for each iteration  $i$  of the outer loop, the two inner loops combined perform  $|T| - i + 1$  iterations.

A compact version of a suffix trie is a *suffix tree*, in which there are no internal nodes with only one descendant. A suffix tree can be obtained from a suffix trie by labeling each edge with the substring of  $T$  that corresponds to the concatenation of characters on the subpaths of the trie in which only nodes with one descendant are used. In other words, one-descendant nodes on such subpaths are merged into one single node, and the edges on such subpaths are merged into one edge. By converting the trie in Figure 13.4a, a suffix tree in Figure 13.4c is created. A suffix tree can have up to  $|T|$  leaves and thus up to  $|T| - 1$  nonleaves. It has exactly  $|T| - 1$  nonleaves if it has  $|T|$  leaves, each nonleaf has two descendants, and no suffix is represented by a path that ends in a nonleaf (see Section 6.1 and Figure 6.5). In this way, space requirements for a suffix tree are linear in the length of the text.

In a suffix tree, most of the nodes are implicit; these are the nodes that in a corresponding trie have one descendant. The problem with processing a suffix tree is determining when an implicit node has to be made explicit. The situation is illustrated by inserting the suffix *caracas* into the tree in Figure 13.4b, which requires splitting the edge labeled *cas* into two edges, labeled *ca* and *s*, and then inserting a new edge labeled *racas*, as shown in Figure 13.4c. For practical purposes, it is more convenient to label edges in a suffix tree with two indexes that represent starting and ending positions of a substring of  $T$  that is the word label of the edge.

Here is a summary of an algorithm:

```
bruteForceSuffixTree(text T)
    for each suffix s of T
        determine the head of s (find the longest match for the longest prefix of s and a path from the root);
```

```

if the suffix of the head matches an entire label of an edge that ends in a leaf
    extend the label by the unmatched part of s;
else if the suffix of the head matches an entire label of an edge that ends in a nonleaf
    create a leaf connected to the nonleaf with an edge labeled by the unmatched part of s;
else split the edge(u, v) partially matched with the suffix of the head into
    edge(u, w) labeled with the part of the current label matching the longest suffix of the head and
    edge(w, v) labeled with the unmatched part of the current label and
    create edge(w, u) labeled with the unmatched part of s;

```

Processing can be done in at least two ways, left to right or right to left. The suffix tree in Figure 13.4c is created by processing suffixes of *caracas* right to left, from the smallest suffix to the largest, which is reflected in the order in which nodes have been created.

The algorithm executes in  $O(|T|^2)$  time due to a straightforward strategy to determine the head: The search always starts at the root, which requires performing  $|head(i)|$  steps in each iteration, which in the worst case is  $|T| - i$ ; that is, the length of suffix  $- 1$ . To see that, consider string  $a^k b$ . The complexity can be improved by devising quicker ways of determining heads of suffixes, which is accomplished by maintaining additional links in the suffix tree. One such suffix tree is constructed by an algorithm devised by Esko Ukkonen.

Conceptually, a suffix tree is a compressed suffix trie, so the presentation of the Ukkonen algorithm for a suffix tree (Ukkonen, 1995) is better understood when started with the discussion of an algorithm for suffix tries (Ukkonen and Wood, 1993).

Ukkonen suffix tries and suffix trees use *suffix links* in the construction (these links are the same as failure transitions in the Aho-Corasick algorithm).

A new suffix trie is obtained from an existing suffix trie by extending paths corresponding to all suffixes of the subtext  $T(0 \dots i - 1)$  by adding new transitions corresponding to the character  $T_i$ . In this way, a new trie has paths for all suffixes of the subtext  $T(0 \dots i)$ . The states for which new transitions are added can be found using suffix links that form a path from the deepest node to the root. This path is called the *boundary path*. The path is traversed, and for each encountered node  $p$  a new leaf  $q$  is created with the *edge*( $p, q, ch$ ) (i.e., an edge from  $p$  to  $q$  labeled  $ch$ ) if there is no  $ch$ -edge coming out of  $p$ . The path traversal is aborted after the first node is encountered for which there is a  $ch$ -edge.

Also, new suffix links are created that form a path that joins together the newly added nodes. The new suffix links are a part of the boundary path of the updated trie.

The algorithm is as follows:

```

UkkonenSuffixTrie(text T)
    create newNode;
    root = deepestNode = oldNewNode = newNode;
    suffixLink(root) = null;
    for i = 0 to |T|-1
        node = deepestNode;
        while node is not null and  $T_i$ -edge from node does not exist
            create newNode;
            create edge(node, newNode,  $T_i$ );

```

```

    if node ≠ deepestNode
        suffixLink(oldNewNode) = newNode;
    oldNewNode = newNode;
    node = suffixLink(node);
if node is null
    suffixLink(newNode) = root;
else suffixLink(newNode) = child of node through  $T_i$ -edge;
deepestNode = child of deepestNode through  $T_i$ -edge;

```

The algorithm is executed in the time proportional to the number of different substrings of the text  $T$ , which can be quadratic, as, for example, for a text with all different characters.

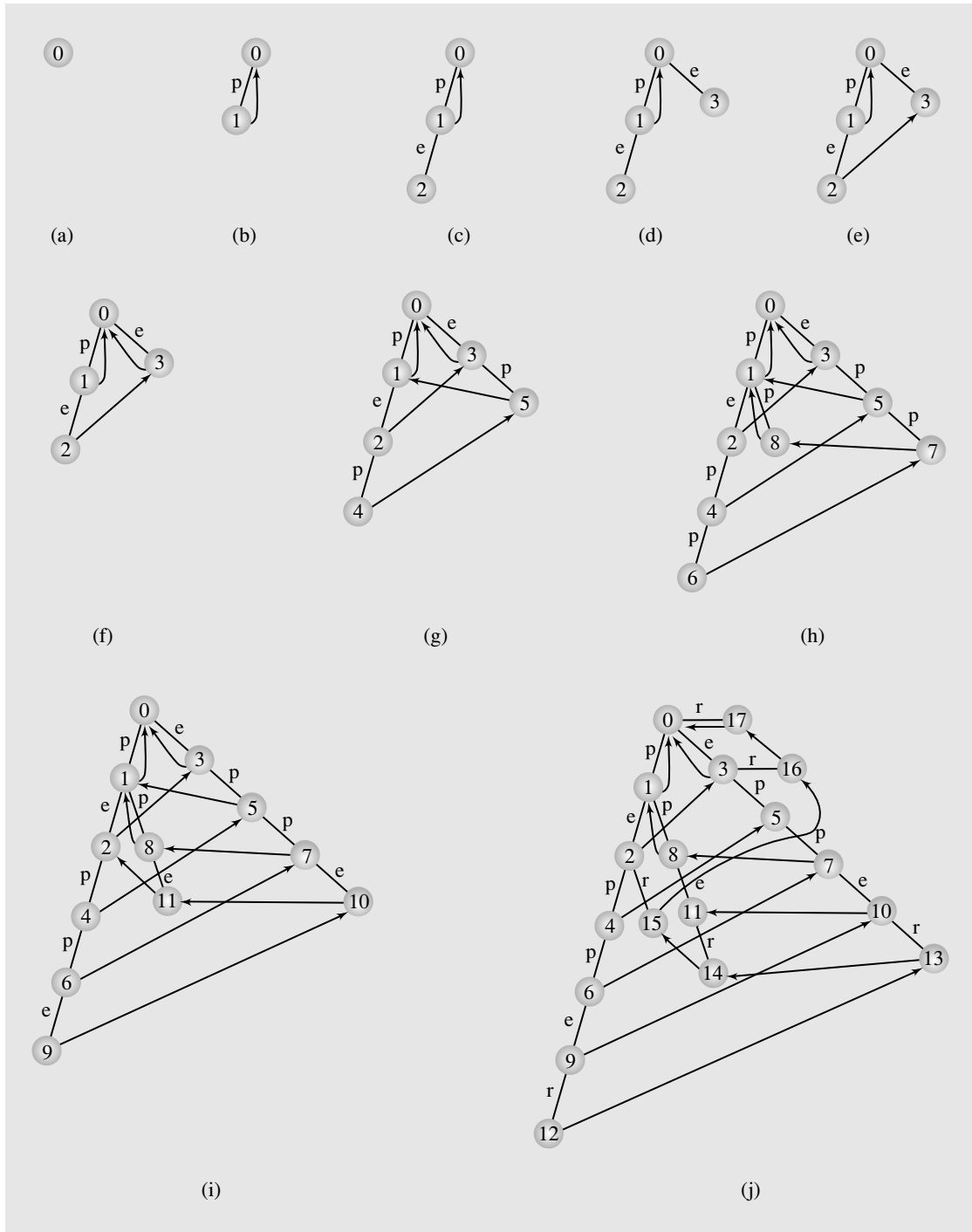
For an example, consider building a suffix trie for the word *pepper*. The trie is initialized to a one-node tree (Figure 13.5a). In the first iteration of the `for` loop, a new node is created with an edge corresponding to letter *p* between the root and the new node; a suffix link from the new node to the root also is created (Figure 13.5b). In the second iteration of the `for` loop, the letter *e* is processed. A new node is created in the first iteration of the `while` loop (Figure 13.5c). In the second iteration of the `while` loop, first another new node is created (Figure 13.5d), then a suffix link is established (Figure 13.5e), and after exiting the `while` loop, another suffix link is created (Figure 13.5f). Figure 13.5g–f shows the trie being expanded for each subsequent letter of the word *pepper*. The numbers in the nodes indicate the order in which the nodes have been created.

To improve on space requirements for a suffix trie, a suffix tree is used in which only those nodes of a trie that have at least two descendants are included. In this way, the suffix tries in Figures 13.5b and 13.5f–j can be transformed into corresponding suffix trees in Figure 13.6a–f. Note that only suffix links from nonleaves are indicated because, as discussed later in Section 13.3, leaves and thus suffix links from leaves are not indispensable for the proper processing of a suffix tree.

The problem now is that in order to expand the tree in Figure 13.6c into the tree in Figure 13.6d by processing letter *p*, an implicit node between substrings *p* and *ep* has to be made explicit and then a new leaf is attached to it with the edge labeled *p*. The old leaf is retained and also attached to the newly created explicit node and connected with the edge with the modified (extended) label *epp*. To develop an algorithm for a suffix tree, consider again the processing of a trie.

The first nonleaf on the boundary path is called an *active point*. When processing a trie, a new *ch*-edge and a new leaf are added for each leaf on the boundary path—that is, for each node that precedes the active point. Then, each node on the subpath between the active point and the so-called *endpoint* also receives a new *ch*-edge to a new leaf. Therefore, an endpoint is a node for which a *ch*-edge already exists, and thus such a *ch*-edge exists for all the nodes on the boundary path from the endpoint to the root. An endpoint can be a virtual parent of the root if the root also acquires a new *ch*-edge (it is assumed that between such a virtual parent and the root there is a *ch*-edge for each letter). For example, in Figure 13.5i, on the boundary path 9 10 11 2 3 0 –1, node 2 is the active point and node –1, the virtual parent of the root, is the endpoint with respect to character *r*, which is inserted into this trie. If *p* were inserted into this trie, then the active point would be the same, but node 2, the active point, would be the endpoint.

**FIGURE 13.5** Creating an Ukkonen suffix trie for the string *pepper*.





### 13.1.9 Suffix Arrays

Sometimes suffix trees may require too much space. A very simple alternative to suffix trees are suffix arrays (Manber and Myers, 1993).

Suffix array  $pos$  is the array of positions 0 through  $|T| - 1$  of suffixes taken in lexicographic order. It is obvious that the suffix array requires  $|T|$  cells. For example, suffixes of text  $T = proposition$  are ordered as follows:

```

8 ion
6 ition
10 n
9 on
2 oposition
4 osition
3 position
0 proposition
1 roposition
5 sition
7 tion

```

with their positions in the text indicated on the left-hand side; these positions form a suffix array  $pos = [8\ 6\ 10\ 9\ 2\ 4\ 3\ 0\ 1\ 5\ 7]$  that corresponds to the order of the suffixes.

The suffix array can be created in  $O(|T| \lg |T|)$  time by sorting an array initialized as  $[0\ 1\ \dots\ |T| - 1]$ . The sorting routine compares suffixes but moves numbers in  $pos$  when the suffixes indicated by the positions are out of sequence.

The suffix array can be created from an existing suffix tree on which an ordered depth-first traversal is performed. For each node of the tree, the traversal traverses its subtrees according to the order of word labels of the outgoing edges, which is the order of the first letters in these labels. The traversal inserts in the suffix array the leaf numbers in the order of reaching the leaves. The edges can be sorted in  $O(|A| \lg |A|)$  time so that traversal is executed in  $O(|T||A| \lg |A|)$  time. The suffix tree routine can maintain the edges on a linked list in sorted order, which amounts to  $O(|A|^2)$  time to maintain one such list and thus  $O(|T||A|^2)$  time to maintain the tree. Only then can the traversal be done in linear time,  $O(|T|)$ .

With the suffix array, a pattern  $P$  can be found very quickly in text  $T$  by using binary search (see Section 2.7) and then all suffixes with prefix  $P$  are grouped together. To locate the beginning of the cluster of such suffixes, the following version of binary search can be used:

```

binarySearch(pattern P, text T, suffix array pos)
    left = 0;
    right = |T|; // that is, |pos|;
    while left < right
        middle = (left+right)/2;
        if P ≤ T(pos[middle]...|T|-1)
            right = middle;
        else left = middle+1;
    if P is equal to T(pos[left]...pos[left]+|P|)
        return left;
    else return -1; // failure;

```

To locate the end of the cluster of such suffixes, the inequality  $\leq$  in the `if` statement should be turned into  $\geq$ , and `left` should be replaced by `right` in the `if` statement following the loop. Pattern  $P$  is found in  $T$  at positions located in the cluster just determined. The cluster is determined in  $O(|P| \lg |T|)$  time, where  $\lg |T|$  refers to the number of iterations of the `while` loop of `binarySearch()`, and  $|P|$  refers to the number of character comparisons between  $P$  and suffixes of  $T$  in one iteration of the loop.

## 13.2

### APPROXIMATE STRING MATCHING

In preceding sections, algorithms for exact matching were analyzed, which was an all-or-nothing proposition: A search for a pattern  $P$  in a text  $T$  is considered successful if there is at least one substring in  $T$  that is equal to  $P$ . If there is at least one character difference, the substring is not considered a match for  $P$ . In many situations, however, the requirement for exact match can be relaxed by stating that only a certain level of similarity between  $P$  and  $T$  (or its substring) is needed to consider a match successful.

A popular measure of the similarity of two strings is the number of elementary edit operations that are needed to transform one string into another. Three elementary operations on strings are considered: insertion I, deletion D, and substitution S. The differences between two strings is sought in terms of these operations. These differences can be represented in at least three ways: trace, alignment (matching), and listing (derivation). For example,

```
alignment:
-app--le      source
capital-     target
```

```
listing:
apple        source
capple (I)
capile (S)
capitle (I)
capitale (I)
capital (D) target
```

```
trace:
apple        source
↓↓↓ ↘
capital     target
```

Lines in the trace cannot cross one other, and only one line can connect a source character with a target letter. A letter with no line in the source indicates a deletion; a letter with no line in the target indicates an insertion. Lines connect a source letter with the same letter of the target or a letter that is substituted for another letter.

Alignment is obtained by aligning two strings that may include null characters indicated by dashes. A dash in the source indicates an insertion; a dash in the target indicates a deletion.



Listings directly correspond to the way strings are processed by a particular algorithm, alignments and traces summarize the work more succinctly and legibly.

The most popular measure of distance between two strings is the *Levenshtein distance*. In fact, Levenshtein (1965) introduced two concepts of distance  $d(Q,R)$  between two strings  $Q$  and  $R$ . One is the smallest number of insertions, deletions, and substitutions needed to convert  $Q$  into  $R$ . Another distance takes only deletions and insertions into account.

Mathematically, distance is a function  $d$  that satisfies the following conditions. For any  $Q, R$ , and  $U$ :

$$\begin{aligned} d(Q,R) &\geq 0 \\ d(Q,R) &= 0 \text{ iff } Q = R \\ d(Q,R) &= d(R,Q) \text{ (symmetry)} \\ d(Q,R) + d(Q,U) &\geq d(Q,U) \text{ (triangle inequality)} \end{aligned}$$

Most distance functions used for string processing meet these requirements, including the Levenshtein distance, but exceptions are possible. Also, distances that include weights are possible. For example, in microbiological applications, a single deletion of two neighboring string elements may be much more likely than two separate deletions of single elements. In such a case, a larger weight is used for two consecutive deletions than for two separate deletions.

### 13.2.1 String Similarity

The string similarity problem arises when for two strings  $R$  and  $Q$ , the distance  $d(Q,R)$  between these two strings needs to be determined.

Let  $D(i,j) = d(Q(0 \dots i-1), R(0 \dots j-1))$  be the edit distance between prefixes  $Q(0 \dots i-1)$  and  $R(0 \dots j-1)$ . The string similarity problem can be approached by reducing the problem of finding the minimum distance for a particular  $i$  and  $j$  to the problem of finding the minimum distance for values not larger than  $i$  and  $j$ . If the subproblems are solved, then the solution can be extended to  $i$  and  $j$  by observing which operation is needed to find correspondence between characters  $Q_i$  and  $R_j$ . There are four possibilities:

1. *Deletion.* When  $Q_i$  is deleted from  $Q(0 \dots i)$ , then  $D(i-1, j-1) = D(i-2, j-1) + 1$ ; that is, the minimum distance between  $Q(0 \dots i)$  and  $R(0 \dots j)$  equals the minimum distance between  $Q(0 \dots i-1)$  and  $R(0 \dots j)$  plus 1, where 1 signifies deletion of  $Q_i$  from the end of  $Q(0 \dots i)$ .
2. *Insertion.* When  $R_j$  is inserted into  $R(0 \dots j-1)$ , then  $D(i-1, j-1) = D(i-1, j-2) + 1$ ; that is, the minimum distance between  $Q(0 \dots i)$  and  $R(0 \dots j)$  equals the minimum distance between  $Q(0 \dots i)$  and  $R(0 \dots j-1)$  plus 1, where 1 signifies insertion of  $R_j$  at the end of  $R(0 \dots j-1)$ .
3. *Substitution.* When  $R_j$  is substituted in  $R(0 \dots j)$  for  $Q_i \neq R_j$  in  $Q(0 \dots i)$ , then  $D(i-1, j-1) = D(i-2, j-2) + 1$ ; that is, the minimum distance between  $Q(0 \dots i)$  and  $R(0 \dots j)$  equals the minimum distance between  $Q(0 \dots i-1)$  and  $R(0 \dots j-1)$  plus 1, where 1 signifies the substitution operation.

4. *Match.* When  $Q_i = R_j$ , no additional operation is needed, and thus  $D(i-1, j-1) = D(i-2, j-2)$ ; that is, the minimum distance between  $Q(0 \dots i)$  and  $R(0 \dots j)$  equals the minimum distance between  $Q(0 \dots i-1)$  and  $R(0 \dots j-1)$ .

All these conditions can be combined into one recurrence relation:

$$D(i, j) = \min(D(i-1, j) + 1, D(i, j-1) + 1, D(i-1, j-1) + c(i, j))$$

where  $c(i, j) = 0$  if  $Q_i = R_j$  and 1 otherwise.

Moreover, to transform a nonempty string into an empty string, all its characters have to be deleted, so that

$$D(i, 0) = i$$

and to transform an empty string into a nonempty string, all its characters have to be inserted, that is,

$$D(0, j) = j$$

The problem can be solved recursively by directly using the equations. However, in this way, the problem of large size is reduced to three problems that are only slightly smaller, which, in effect triples the effort needed at a particular level of recursion. The smaller problems have to be solved separately, which triples the effort for every one of them and means a nine-fold increase of effort for the previous level of recursion. Eventually, the original problem requires exponential effort to be solved. To avoid the use of excessive recursion, the problem is solved differently.

One solution is to use a 2D *edit table*, in which the results of iteratively solved sub-problems, from smallest to largest, are recorded. We use an  $(|R| + 1) \times (|Q| + 1)$  edit table  $dist[0 \dots |R|, 0 \dots |Q|]$  for which  $dist[i, j] = D(i, j)$ ; that is, its rows correspond to characters in  $R$  and columns to characters in  $Q$ . The first row corresponds to values  $D(0, j)$  and thus is initialized with numbers  $0, 1, \dots, |R|$ . Similarly, the first column corresponds to values  $D(i, 0)$  and so is initialized with numbers  $0, 1, \dots, |Q|$ . Afterwards, for each cell of the table, the value stored in the cell is determined in accordance with the recurrence relation for  $D(i, j)$ , which means that it refers to three cells: one above, one to the left, and one positioned diagonally. Here is an algorithm devised by Wagner and Fischer (1974):

```

WagnerFischer(edit table dist, string Q, string R)
  for i = 0 to |Q|
    dist[i, 0] = i;
  for j = 0 to |R|
    dist[0, j] = j;
  for i = 1 to |Q|
    for j = 1 to |R|
      x = dist[i-1, j]+1; // upper
      y = dist[i, j-1]+1; // left
      z = dist[i-1, j-1]; // diagonal
      if  $Q_{i-1} \neq R_{j-1}$ 
        z++;
      dist[i, j] = min(x, y, z);

```

It is clear from the use of nested `for` loops that the algorithm runs in  $O(|Q||R|)$  time and space.

Consider strings  $Q = \textit{capital}$  and  $R = \textit{apple}$  and the edit table *dist* created for them:

		a	p	p	l	e
	0	1	2	3	4	5
c	1	1	2	3	4	5
a	2	1	2	3	4	5
p	3	2	1	2	3	4
i	4	3	2	2	3	4
t	5	4	<b>3</b>	<b>3</b>	3	4
a	6	5	<b>4</b>	<b>4</b>	4	4
l	7	6	5	5	4	5

After initializing the first row and first column, the value for each cell is found by using values of the three mentioned neighboring cells. For example, to determine the value  $D(6,3)$ —that is, the value  $dist[6,3] = 4$ , which is shown in italics in the diagram—the three neighbors shown in bold type are consulted. There are two candidates for the minimum value, both with a value of 3:  $dist[5,2]$  and  $dist[5,3]$ . If the first is chosen, then we choose the operation of substitution, because the sixth character in *capital*, character *a*, is different from the third character in *apple*, character *p*. In this way,  $D[6,3] = d(capita,app) = d(capit,ap) + 1 = 4$ . When the second candidate is chosen, then we choose the operation of insertion of *a* in the substring *capit* to obtain substring *capita*, so that  $D[6,3] = d(capita,app) = d(capit,app) + 1 = 4$ .

The number in the lower right corner of *dist*, number 5, is the minimum distance between strings *capital* and *apple*. The table can be used to generate an alignment so that not only  $d(capital,apple)$  is known, but also a listing. If we are interested in only one possible listing, then it can be generated with the following algorithm:

```

WagnerFisherPrint(edit table dist, string Q, string R)
    i = |Q|;
    j = |R|;
    while i ≠ 0 or j ≠ 0
        output pair (i, j);
        if i > 0 and dist[i-1,j] < dist[i,j]           // up
            sQ.push(Qi-1);
            sR.push('-');
            i--;
        else if j > 0 and dist[i,j-1] < dist[i,j]     // left
            sQ.push('-');
            sR.push(Rj-1);
            j--;
        else // if i > 0 and j > 0 and                // diagonally
            // (dist[i-1,j-1] == dist[i,j] and Qi-1 == Rj-1 or
            // dist[i-1,j-1] < dist[i,j] and Qi-1 ≠ Rj-1)
            sQ.push(Qi-1);
            sR.push(Rj-1);
            i--;
            j--;
    print stack sQ;
    print stack sR;

```

At least one of the indexes  $i$  and  $j$  is decremented in each iteration of the `while` loop, so the algorithm runs in  $O(\max(|Q|, |R|))$  time.

Two stacks are used to generate the elements of the alignment. Stacks are very suitable here because the source and target of the alignment are generated backwards. Processing starts in the lower right corner, and for each cell  $c$  it goes to one of the three neighbors whose values were used to determine the value stored in  $c$ ; depending on which neighbor it is, either a character from a string or a dash is stored—a dash in the target to indicate a deletion, and a dash in the source to indicate an insertion. The algorithm `WagnerFisherPrint()` generates this output:

```
path: [ 7 5] [ 6 5] [ 5 4] [ 4 3] [ 3 2] [ 2 1] [ 1 0]
capital
-apple-
```

As an extra, the path from the lower right corner to the upper left corner is also generated. The order of `if` statements in the algorithm determines which alignment is generated. If the first `if` statement is exchanged with the second, then the output is

```
path: [ 7 5] [ 7 4] [ 6 3] [ 5 3] [ 4 3] [ 3 2] [ 2 1] [ 1 0]
capital-
-app--le
```

It is also possible to generate all alignments and print them after removing duplicates.

The Wagner-Fisher algorithm can be improved in many ways, one way being the reduction of space from  $O(|Q||R|)$  to  $O(|R|)$  (Drozdek 2002), another way is improving running time when sequences are far apart (Hunt and Szymanski 1977).

For two strings  $Q$  and  $R$ , a common subsequence is the sequence of characters that occurs in both strings, not necessarily in consecutive order. For example, *es*, *ece*, and *ee* are common subsequences in *predecessor* and *descendant*. The longest common subsequence problem is the task of determining what is the longest subsequence found in two strings  $Q$  and  $R$ . A strong connection exists between the longest common subsequence and edit distance.

It is clear that the length of the longest common subsequence  $lcs(Q, R)$  is the largest number of pairs  $(i, j)$  in any alignment in which equal characters  $Q_i$  and  $R_j$  are aligned. Let us consider such an alignment. Define a new edit distance  $d_2$  in which the cost of insertion and deletion is 1, but the cost of substitution is 2 for unequal characters and 0 when they are equal. This amounts to the more restricted concept of Levenshtein edit distance, which includes only deletion and insertion, because substitution is, in effect, replaced by deletion followed by an insertion. In this case,

$$d_2(Q, R) = |Q| + |R| - 2lcs(Q, R)$$

because

$$d_2(Q, R) = \#deletions + \#insertions + 2 \cdot \#substitutions$$

$$d_2(Q, R) = |Q| - \#substitutions - lcs(Q, R) + |R| - \#substitutions - lcs(Q, R) + 2 \cdot \#substitutions$$

The longest common subsequence can be found with the following algorithm:

```

HuntSzymanski(Q, R)
  for i = 0 to |Q|-1
    matchlist[i] = list in descending order of positions j for which Qi == Rj;
  for i = 1 to |Q|
    threshold[k] = |R|+1;
  threshold[0] = -1;
  for i = 0 to |Q|-1
    for each j in matchlist[i]
      find position k such that threshold[k] < j ≤ threshold[k+1];
      if j < threshold[k+1]
        threshold[k+1] = j;
        link[k] = new node(i, j, link[k-1]);
  k = max{t: threshold[t] < |R|+1};
  for (p = link[k]; p ≠ null; p = prev(p)) // print pairs in reverse order;
    output pair (i, j) in node p;

```

The *matchlist* is a table of lists of positions in descending order and a list *matchlist*[*i*] includes all positions *j* for which  $Q_i = R_j$ . The lists can be created in  $O(|R||g|R| + |Q||g|R|)$  time by sorting in  $O(|R||g|R|)$  time a copy of *R* while remembering original positions of its characters, and then for each position *i* extracting the list of positions corresponding to character  $Q_i$  using binary search to locate this list. For example, for strings  $Q = \textit{rapidity}$  and  $R = \textit{paradox}$ , the lists are as follows:

```

r: matchlist[0] = (2)
a: matchlist[1] = (3 1)
p: matchlist[2] = (0)
i: matchlist[3] = ()
d: matchlist[4] = (4)
i: matchlist[5] = ()
t: matchlist[6] = ()
y: matchlist[7] = ()

```

that is, the list *matchlist*[0] that corresponds to character *r* in *rapidity* has one number, 2, which is the position of *r* in *paradox*; the list *matchlist*[1] that corresponds to character *a* has two numbers, 3 and 1, which are the positions of *a* in *paradox*, and so on. The lists represent the following table:

```

      p a r a d o x
      0 1 2 3 4 5 6
r 0      x
a 1    x  x
p 2 x
i 3
d 4      x
i 5
t 6
y 7

```

in which *x*s represent matching characters in the two strings.

To find the longest common sequence (marked with bold *xs*), the table *threshold* is used. Positions marked with *xs* are the positions indicated by the positions *k* in *threshold* and the numbers in this position, which can change during execution of the algorithm. Numbers in *threshold* are in ascending order so that the required position *k* can be found in  $\lg|R|$  time with binary search. Denote by *r* the number of pairs  $(i, j)$  for which  $Q_i = R_j$ . Because there are *r* iterations of the inner **for** loop, one for each number in *matchlist*, this phase is executed in  $O(r\lg|R|)$  time, during which up to *r* nodes in *link* can be created.

Here are the changes in *threshold*, *link*, and some variables during processing of strings  $Q = \textit{rapidity}$  and  $R = \textit{paradox}$ :

	p a r a d o x	i j k	threshold	link
	0 1 2 3 4 5 7		0 1 2 3 4 5 6 7 8	
r 0	<b>x</b>	0 2 0	-1 2 8 8 8 8 8 8 8	link[0] = (0, 2)
a 1	<b>x</b>	1 3 1	-1 2 3 8 8 8 8 8 8	link[0] = (0, 2)
				link[1] = (1, 3)↗
a 1	<b>x</b>	1 1 0	-1 1 3 8 8 8 8 8 8	link[0] = (1, 1)
				link[1] = (1, 3)→(0, 2)
p 2	<b>x</b>	2 0 0	-1 0 3 8 8 8 8 8 8	link[0] = (2, 0)
				link[1] = (1, 3)→(0, 2)
i 3		3	-1 0 3 8 8 8 8 8 8	
d 4	<b>x</b>	4 4 2	-1 0 3 4 8 8 8 8 8	link[0] = (2, 0)
				link[1] = (1, 3)→(0, 2)
				link[2] = (4, 4)↗
i 5		5	-1 0 3 4 8 8 8 8 8	
t 6		6	-1 0 3 4 8 8 8 8 8	
y 7		7	-1 0 3 4 8 8 8 8 8	

Position 0 of *threshold* always equals -1. At the end of iteration *i*, *threshold*[*k* + 1] is the position *j* for which the length of common subsequence for  $Q(0 \dots i)$  and  $R(0 \dots j)$  equals *k* + 1.

In the first iteration of the outer **for** loop, a match for the first character in *rapidity*, *r*, when *i* = 0, is retrieved from *matchlist*[0], which is the position *j* = 2 of *paradox*, and 2 is assigned to *threshold*[0], which indicates that there is a common subsequence of length 1 for  $Q(0 \dots 0) = r$  and  $R(0 \dots 2) = \textit{par}$ . The subsequences themselves are stored as a pair of indexes (0,2) on *link*[0] because list *link*[*k*] defines a list of *k* + 1 pairs  $(i, j)$  that record a common subsequence of length *k* + 1.

In the second iteration of the outer **for** loop, when *i* = 0, the inner **for** loop is activated twice for the two numbers in *matchlist*[*i* = 1] = (3 1). First, number *j* = 3 is stored in *threshold*[*k* = 1] to indicate that substrings  $Q(0 \dots 1) = ra$  and  $R(0 \dots 3) = \textit{para}$  have a common subsequence of length *k* + 1 = 2. In the second iteration of the inner **for** loop, number *j* = 1 overwrites 2 in *threshold*[0] to indicate that substrings  $Q(0 \dots 1) = ra$  and  $R(0 \dots 1) = \textit{pa}$  have a common subsequence of length 1. The subsequences are recorded in *link*. Note that *link*[0] is updated but the second node on *link*[1] remains the same. This node is now accessible only from the first node in list *link*[1], whereas before the update of *link*[0], it was also accessible from *link*[0].

In its last phase, the algorithm prints the  $(i, j)$  pairs in reverse order:

[4 4] [1 3] [0 2]

The algorithm runs in  $O((|Q| + |R| + r)\lg|R|)$  time and  $O(r + |Q| + |R|)$  space. The algorithm is particularly efficient when sequences are far apart; that is, when most positions of one string match only a few positions in the other string, in which case  $r$  is small in comparison with the length of the two strings so that the algorithm runs in  $O((|Q| + |R|)\lg|R|)$  time. However, in the worst case, for strings  $aaa \dots$  and  $aaa \dots$ ,  $r = |Q||R|$  and the algorithm runs in unpromising  $O(|Q||R|\lg|R|)$  time.

It is worth noticing that the Hunt-Szymanski algorithm is implemented as the *diff* command in UNIX.

### 13.2.2 String Matching with $k$ Errors

Our task is now to determine all substrings of text  $T$  for which the Levenshtein distance does not exceed  $k$ ; that is, we would like to perform string matching with at most  $k$  errors (or  $k$  differences).

In Section 13.1.5, we discussed the `shiftAnd()` algorithm for exact matching. The algorithm relied on bitwise operations, and Wu and Manber (1992) devised a generalization of `shiftAnd()` that can be used for approximate matching. The algorithm is implemented in UNIX as *agrep*, the approximate *grep* command.

Consider the case when the only edit operation is insertion and  $k = 2$ . For each prefix of  $P$  and a substring ending at character  $T_i$ , there may be now an exact match, a match with one insertion, and a match with two insertions. To handle all three possibilities, three tables are used— $state_0 = state$  as used in `shiftAnd()`,  $state_1$ , and  $state_2$ , where  $state_k$  indicates all matches with up to  $k$  insertions. A value in  $state_k$  is determined from the corresponding value in  $state_{k-1}$  and the characters  $P_j$  and  $T_i$  being compared.

If there is an exact match between  $P(0 \dots j-1)$  and  $T(i-j \dots i-1)$  and  $P_j = T_i$ , then the exact match continues for  $P(0 \dots j)$  and  $T(i-j \dots i)$ , and this fact has to be reflected in all three state tables,  $state_0$ ,  $state_1$ , and  $state_2$ . If there is an exact match between  $P(0 \dots j-1)$  and  $T(i-j \dots i-1)$  and  $P_j \neq T_i$ , then an approximate match with one insertion of  $T_i$  is marked in  $state_1$  and  $state_2$ . In effect,  $P_0P_1 \dots P_{j-1}$  (note the dash) is approximately matched with  $T_{i-j}T_{i-j+1} \dots T_i$ . Finally, if there is an approximate match with one insertion between  $P(0 \dots j-1)$  and  $T(i-j \dots i-1)$  and  $P_j \neq T_i$ , then an approximate match with two insertions, of  $T_{i-j+s}$  for some  $0 \leq s \leq j-1$ , and of  $T_i$ , is marked in  $state_2$ . This means that  $P_0P_1 \dots P_{s-1}P_{s+1} \dots P_{j-1}$  (note two dashes) is approximately matched with  $T_{i-j}T_{i-j+1} \dots T_i$ . However, if  $P_j = T_i$ , then the one-insertion match continues, which has to be reflected in both  $state_1$  and  $state_2$ . Therefore, all the matches indicated in  $state_e$  are also found in  $state_s$  for  $e < s \leq k$ ; that is, the amount of information grows with the increase of subscript  $e$  in  $state_e$  because criteria for matching become more and more relaxed. Consider pattern  $P = abc$  and text  $T = abaccabc$ . The situation in table  $state_0$  changes as follows:

$i = 0$		1	2	3	4	5	6	7
$T =$	abaccabc	abaccabc	abaccabc	abaccabc	abaccabc	abaccabc	abaccabc	abaccabc
a 0	a		a			a		
b 1		ab					ab	
c 2								abc

For  $i = 0$ , substrings  $P(0 \dots 0)$  and  $T(0 \dots 0)$  are matched, for  $i = 1$ , a match is continued for substrings  $P(0 \dots 1)$  and  $T(0 \dots 1)$ , but for  $i = 2$ ,  $P_2 \neq T_2$ , so the matching for  $P(0 \dots 1)$  and  $T(0 \dots 1)$  has to be discontinued. But there is a match for  $P(0 \dots 0)$  and  $T(2 \dots 2)$ . However, the latter match is also discontinued for  $i = 3$ . An exact match is found for  $i = 7$ .

Table  $state_1$  is richer with information:

$i = 0$	1	2	3	4	5	6	7
T = abaccabc	abaccabc	abaccabc	abaccabc	abaccabc	abaccabc	abaccabc	abaccabc
a 0	a	a-	a	a-	a	a-	
b 1	ab	ab-				ab	ab-
c 2			ab-c				abc

For  $i = 0$ , as before, substrings  $P(0 \dots 0)$  and  $T(0 \dots 0)$  are matched; for  $i = 1$ , a match is continued for substrings  $P(0 \dots 1)$  and  $T(0 \dots 1)$ , but also a match with one insertion, for  $P(0 \dots 0)$ - (one dash) and  $T(0 \dots 1)$ . This approximate match cannot be continued for  $i = 2$ , when  $P_2 \neq T_2$ , but the approximate match  $P(0 \dots 1)$ - (one dash) and  $T(0 \dots 2)$  can, which leads to a successful approximate match of the entire pattern with substring  $T(0 \dots 3)$  in step  $i = 3$ . Note that the substrings in  $state_0$  appear in  $state_1$ , which leads to reflecting the exact match between  $P$  and  $T(5 \dots 7)$  also in  $state_1$ .

Finally, table  $state_2$ :

$i = 0$	1	2	3	4	5	6	7
T = abaccabc	abaccabc	abaccabc	abaccabc	abaccabc	abaccabc	abaccabc	abaccabc
a 0	a	a-	a	a-	a--	a	a--
		a--					
b 1	ab	ab-	ab--			ab	ab-
c 2			ab-c	ab--c			abc

Substrings are matched and extended similarly to entries in  $state_0$  and  $state_1$ . Note that for  $i = 2$ , there are two matches for  $P(0 \dots 0)$ : with  $T(0 \dots 2)$ , with two insertions, and an exact match with  $T(2 \dots 2)$ . For  $i = 4$ , there is a match with two insertions between  $P$  and  $T(0 \dots 4)$ , a match that did not appear in the previous tables.

In the tables used thus far, only exact matches and matches with insertions were analyzed. The situation is similar for two other edit operations, deletion and substitution. Moreover, we need to consider a general case for  $k$  errors in a match.

All the possibilities for matching  $P(0 \dots j)$  with a substring of  $T$  that ends at position  $i$  with  $e \leq k$  errors can be summarized as follows.

1. *Match.*  $P_j = T_i$ , and there is a match with  $e$  errors between  $P(0 \dots j-1)$  and a substring ending at  $T_{j-1}$ .
2. *Substitution.* There is a match with  $e-1$  errors between  $P(0 \dots j-1)$  and a substring ending at  $T_{j-1}$ .
3. *Insertion.* There is a match with  $e-1$  errors between  $P(0 \dots j)$  and a substring ending at  $T_{j-1}$ .
4. *Deletion.* There is a match with  $e-1$  errors between  $P(0 \dots j-1)$  and a substring ending at  $T_j$ .



A  $state_e$  can be derived from a preceding  $state_{e-1}$  in a remarkably simple manner by generalizing the formula used in implementation of `shiftAnd()`:

$$state_{e,i+1} = 11 \dots 1100 \dots 00 \text{ with } e \text{ 1s.}$$

$$state_{e,i+1} = (\text{shiftBits}(state_{e,i}) \text{ AND } \text{charactersInP}[T_i]) \text{ OR } \text{shiftBits}(state_{e-1,i}) \text{ OR} \\ \text{shiftBits}(state_{e-1,i+1}) \text{ OR } state_{e-1,i}$$

where AND and OR are bitwise operations. AND is used to shift information out; OR is used to accumulate it. With bitwise-or, information included in the preceding state is also included in the current state. Here is an implementation of the algorithm:

```

WuManber(pattern P, text T, int k)
    matchBit = 1;
    for i = 1 to |P|-1
        matchBit <<= 1;
    initialize charactersInP;
    oldState[0] = 0;
    for e = 1 to k
        oldState[e] = (oldState[e-1] << 1) | 1;
    for i = 0 to |T|-1
        state[0] = ((state[0] << 1) | 1) & charactersInP[Ti];
        for e = 1 to k
            state[e] = ((oldState[e] << 1) | 1) & charactersInP[Ti] |
                // insertion
                ((oldState[e-1] << 1) | 1) | // substitution/match
                ((state[e-1] << 1) | 1) | // deletion
                oldState[e-1]; // match
        for e = 0 to k
            oldState[e] = state[e];
    if matchBit & state[k] ≠ 0
        output "a match ending at " i;

```

Creating `charactersInP` takes  $O(|P||A|)$  time; the state arrays require  $k$  space and  $k$  initialization steps. The matching process takes  $O(|T|k)$  steps.

The algorithm can be accelerated using the *partition approach* in the case when  $k$  is small in comparison to  $|P|$ . In this case, the pattern  $P$  is divided into  $k + 1$  or  $k + 2$  blocks, each of the first  $k + 1$  blocks of size  $r = |P|/(k + 1)$ . If there is a match with up to  $k$  errors for  $P$  in  $T$ , then at least one of the first  $k + 1$  blocks is matched without any error. Therefore, if one of the blocks is matched exactly, then an approximate match can be found in the neighborhood of size  $|P|$  of the exact match.

To locate exact matches of the first  $k + 1$  blocks, an algorithm can be used that searches for all the blocks at the same time. To that end, the Aho-Corasick algorithm can be used (Baeza-Yates and Perleberg, 1992), but Wu and Manber propose a small modification of algorithm `shiftAnd()`. Consider the following example. For  $P = abcdefghi$  and  $k = 3$ , the pattern is divided into five blocks  $ab$ ,  $cd$ ,  $ef$ ,  $gh$ , and  $i$ , out of which only the first four are considered. The four blocks are interleaved to form a new pattern  $acegbdfh$  to which `WuManber()` is applied with one difference: Instead of shifting by one in each iteration of the main loop,  $state$  is shifted by four, in which step

four 1s are also shifted in. A match is detected if any of the last four bits is 1. Consider text  $T = aibcdiefgabb \dots$ . Modified `shiftAnd()` renders the following changes of bits in *state*:

1 2 3 4 5 6 7 8 9 10	charactersInP
a i b c d i e f g a b b	a b c d e f g h
1 1 1 1 1 1 1 1 1 1 1	
a 0 1 0 0 0 0 0 0 0 1 0 0	1 0 0 0 0 0 0 0
c 0 0 0 0 1 0 0 0 0 0 0 0	0 0 1 0 0 0 0 0
e 0 0 0 0 0 0 0 1 0 0 0 0	0 0 0 0 1 0 0 0
g 0 0 0 0 0 0 0 0 0 1 0 0	0 0 0 0 0 0 1 0
b 0 0 0 0 0 0 0 0 0 0 1 0	0 1 0 0 0 0 0 0
d 0 0 0 0 0 1 0 0 0 0 0 0	0 0 0 1 0 0 0 0
f 0 0 0 0 0 0 0 0 1 0 0 0	0 0 0 0 0 1 0 0
h 0 0 0 0 0 0 0 0 0 0 0 0	0 0 0 0 0 0 0 1

In step 4, when  $T_3 = c$ ,  $P_1$  is also  $c$ , which is reflected in setting the bit in row 2 (the third row) to 1. Afterwards, *state* is shifted by four and the result is matched with `charactersInP[T4 = 'd']` using bitwise-and, which gives a 1 in row 6, and row 6 is one of the last four rows. This signifies a detection of a block in  $T$ , which happens to be the block  $cd$ , and consequently to a search for an approximate match in its neighborhood. The latter search matches  $P$  with  $T(0 \dots 9) = aibcdiefga$ . Then, we return to finding another occurrence of a block in  $T$ , which occurs at  $T_7$ , for block  $ef$  and then at  $T_7$ , for block  $ab$ .

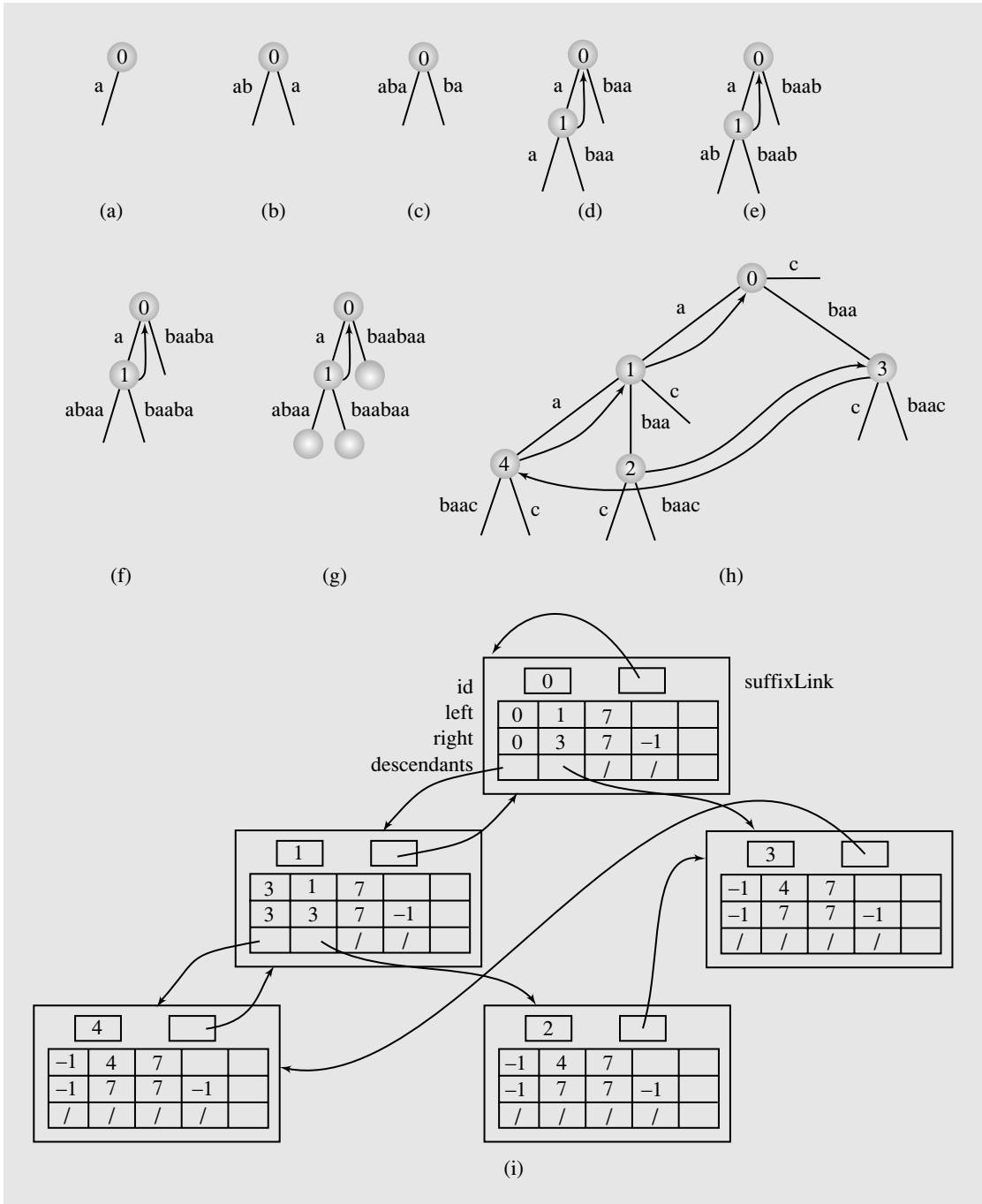
### 13.3

### CASE STUDY: LONGEST COMMON SUBSTRING

Finding the longest common substring of two strings  $Q$  and  $R$  is a classical problem in string processing. It was once conjectured that it is impossible to solve the problem in linear time (Knuth, Morris, and Pratt, 1977); however, using a suffix tree makes it possible. Therefore, before discussing the problem, an implementation of the Ukkonen algorithm to construct a suffix tree from Section 13.1.8 is introduced.

A node in the suffix tree is implemented as an object that includes an array of references to descendants; the array is indexed with letters of the alphabet from which a text  $T$  being processed is built. Also, the node includes arrays for right and left indexes of letters in  $T$  to indicate the label of the edge leading to a descendant. For example, for  $T = abaabaac$  and node 1 in Figure 13.7i, `left['a'-offset] = right['a'-offset] = 3`, which amounts to the label  $a$ ; `left['b'-offset] = 1, right['b'-offset] = 3`, which identifies the label  $baa$ ; and finally, `left['c'-offset] = right['c'-offset] = 7`, which corresponds to the label  $c$ . Also, for node 1, `descendants['a'-offset] = node 4`, `descendants['b'-offset] = node 2`, and `descendants['c'-offset] = null`. Using edge labels and nodes from which the edges originate, each edge can be uniquely identified, which is important in a suffix tree, where some nodes may not be explicit. To that end, the notation `node(explicit node, edge label) = node(explicit node, right, left)` is used. The notation is called a *canonical reference*, and the explicit node used in it, when it is closest to the implicit node for which the reference is used, is called a *canonical node*. For example, in Figure

**FIGURE 13.7** (a–h) Creating an Ukkonen suffix tree for the string *abaabaac*; (i) a data structure used for implementation of the Ukkonen tree (h).



13.7h,  $node(node\ 1, ba) = node(node\ 1, 1, 2)$  identifies an implicit node that falls between  $ba$  and  $a$  on the edge between node 1 and node 2;  $node(node\ 1, \text{null string}) = node(node\ 1, 2, 1)$  identifies node 1 itself.

As discussed in Section 13.1.8, only the nodes of the equivalent of the trie's boundary path have to be updated. The first part of the path includes only leaves; however, there is no need to process the leaves on the boundary path because after processing of a text  $T$ , all the leaves are connected to their parents with edges that are suffixes of  $T$ , so it can be assumed at the outset that each edge is labeled with such a suffix. Therefore, the edges leading to the leaves do not have to be updated, and thus the first `for` loop in `UkkonenSuffixTree()`, presented in Section 13.1.8, can be eliminated. Moreover, as a space saving device, the leaves can also be eliminated by retaining only the edges leading to them. In this way, the worst case for a trie for  $T$  with all different letters when  $1 + (1 + 2 + \dots + |T|)$  nodes are required, turns into a best case tree with one node only, the root.

The second part of the boundary path begins with the first nonleaf, the active point, and ends right before the endpoint. Processing of the suffix tree concentrates on these nodes.

To create a new edge for a node, the node, if it is implicit, has to be made explicit first. To make it explicit, an edge from an explicit parent of the node to the node itself has to be split. To split it, the parent, a canonical node, has to be found first. This is the role of the method `findCanonicalNode()` that for an  $implicitNode = node(explicitNode, left, right)$  determines whether  $explicitNode$  is canonical. If it is, the search is finished; if not, the canonical node is found. For example, for the tree in Figure 13.7g and  $q = node(node\ 0, 5, 6) = node(node\ 0, aa)$ , the canonical node is node 1, and  $q$  becomes explicit as node 4 and a descendant of node 1. After an implicit node  $r$  is made explicit, the edges between  $r$  and its parent and between  $r$  and its descendant are updated; afterwards, whether it was explicit or implicit, the node acquires a new  $T_i$ -edge.

The task of modifying the tree by processing nodes from the active point to the node before the endpoint is performed by the method `update()`. The task of determining whether the current node is an endpoint is performed by `testAndSplit()`.

The processing of a letter  $T_i$  begins from the active point. The point is easily determined because it is the endpoint reached after processing letter  $T_{i-1}$  is finished. To see this, consider processing letter  $T_{i-1}$  in a trie. In the trie's boundary path, each node acquires a new leaf reachable from its parent through a  $T_{i-1}$ -edge. Processing ends at the endpoint that already has a  $T_{i-1}$ -edge. Therefore, all the added leaves are linked in a new boundary path that includes the endpoint. This endpoint is the first nonleaf in the path, and thus it becomes the active point before processing of the letter  $T_i$  begins, and the processing starts from this active point.

By default, each node carries three arrays of 128 cells each, so each text letter would be an index for the arrays. If a range of characters is known, the first and the last characters of the range can be given as arguments to a constructor, whereby the variable `offset` is set to be the first character, and for each text character, the index is found by subtracting the offset.

The code for the suffix tree, which closely follows pseudocode given by Ukkonen (1995), is given in Figure 13.8.

**FIGURE 13.8** Listing of the program to find longest common substring.

```

//***** UkkonenSuffixTree.java *****

import java.io.*;

class SuffixTreeNode {
    public SuffixTreeNode[] descendants;
    public int[] left, right;
    public SuffixTreeNode suffixLink = null;
    public static int cnt = 0; // for printing only;
    public int id = 1; // for printing only;
    public SuffixTreeNode() {
        this(128);
    }
    public SuffixTreeNode(int sz) {
        id = cnt++;
        descendants = new SuffixTreeNode[sz];
        left = new int[sz];
        right = new int[sz];
        for (int i = 0; i < sz; i++)
            left[i] = -1;
    }
}

public class UkkonenSuffixTree {
    protected SuffixTreeNode root;
    protected int size, offset;
    protected String T;
    private int Lt = 1;
    private boolean endPoint;
    public UkkonenSuffixTree() {
        this(0,127);
    }
    public UkkonenSuffixTree(int from, int to) {
        size = to - from + 1;
        offset = from;
        root = new SuffixTreeNode(size);
        root.suffixLink = root;
    }
    public void printTree(int pos) {
        System.out.println();
        printTree(root,0,0,0,pos);
    }
}

```

*Continues*

**FIGURE 13.8** (continued)

```

private void printTree(SuffixTreeNode p, int lvl, int lt, int rt, int pos) {
    for (int i = 1; i <= lvl; i++)
        System.out.print("  ");
    if (p != null) { // if a nonleaf;
        if (p == root)
            System.out.println(p.id);
        else if (p.suffixLink != null) // to print in the middle of
            System.out.println(T.substring(lt,rt+1) // update;
                + " " + p.id + " " + p.suffixLink.id
                + " [" + lt + " " + rt + "]");
        else System.out.println(T.substring(lt,pos+1) + " " + p.id);
        for (char i = 0; i < size; i++)
            if (p.left[i] != -1) // if a tree node;
                printTree(p.descendants[i],lvl+1,p.left[i],p.right[i],pos);
    }
    else System.out.println(T.substring(lt,pos+1) + " [" + lt + " " + rt + "]");
}

SuffixTreeNode testAndSplit(SuffixTreeNode p, int i) {
    int Rt = i-1;
    if (Lt <= Rt) {
        int pos = T.charAt(Lt)-offset;
        SuffixTreeNode pp = p.descendants[pos];
        int lt = p.left[pos];
        int rt = p.right[pos];
        if (T.charAt(i) == T.charAt(lt+Rt-Lt+1)) { // if T(lt..rt) is
            endPoint = true; // and extension of
            return p; // T(Lt..i);
        }
        else{// insert a new node r between s and ss by splitting
            // edge(p,pp) = T(lt..rt) into
            // edge(p,r) = T(lt..lt+Rt-Lt) and
            // edge(r,pp) = T(lt+Rt-Lt+1..rt);
            pos = T.charAt(lt)-offset;
            SuffixTreeNode r = p.descendants[pos] = new SuffixTreeNode(size);
            p.right[pos] = lt+Rt-Lt;
            pos = T.charAt(lt+Rt-Lt+1)-offset;
            r.descendants[pos] = pp;
            r.left [pos] = lt+Rt-Lt+1;
            r.right[pos] = rt;
            endPoint = false;
            return r;
        }
    }
}

```

**FIGURE 13.8** (continued)

```

        else if (p.left[T.charAt(i)-offset] == -1)
            endPoint = false;
        else endPoint = true;
        return p;
    }
private SuffixTreeNode findCanonicalNode(SuffixTreeNode p, int Rt) {
    if (Rt >= Lt) {
        int pos = T.charAt(Lt)-offset;
        SuffixTreeNode pp = p.descendants[pos];
        int lt = p.left[pos];
        int rt = p.right[pos];
        while (rt - lt <= Rt - Lt) {
            Lt = Lt + rt - lt + 1;
            p = pp;
            if (Lt <= Rt) {
                pos = T.charAt(Lt)-offset;
                pp = p.descendants[pos];
                lt = p.left[pos];
                rt = p.right[pos];
                if (p == root)
                    pp = root;
            }
        }
    }
    return p;
}
private SuffixTreeNode update(SuffixTreeNode p, int i) {
    SuffixTreeNode prev = null, r = testAndSplit(p,i);
    while (!endPoint) {
        int pos = T.charAt(i)-offset;
        r.left [pos] = i;      // add a T(i)-edge to r;
        r.right[pos] = T.length()-1;
        if (prev != null)
            prev.suffixLink = r;
        prev = r;
        if (p == root)
            Lt++;
        else p = p.suffixLink;
        p = findCanonicalNode(p,i-1);
        r = testAndSplit(p,i); // check if not the endpoint;
    }
}

```

*Continues*

**FIGURE 13.8** (continued)

```

        if (prev != null)
            prev.suffixLink = p;
        return p;
    }
    public void run(String text) {
        T = text;
        final int n = T.length(), pos = T.charAt(0)-offset;
        SuffixTreeNode canonicalNodeAP = root, canonicalNodeEP;
        root.left [pos] = 0;
        root.right[pos] = n-1;
        for (int i = 1; i < n; i++) {
            canonicalNodeEP = update(canonicalNodeAP,i);
            // and thus, endpoint = node(canonicalNodeEP,Lt,i);
            canonicalNodeAP = findCanonicalNode(canonicalNodeEP,i);
            // and so, active point = node(canonicalNodeAP,Lt,i);
            printTree(i);
        }
    }
}

//***** LongestCommonSubstring.java *****

public class LongestCommonSubstring extends UkkonenSuffixTree {
    public LongestCommonSubstring(int from, int to) {
        super(from,to+2);
    }
    private int s1length, position, length;
    private void findLongest(String s1, String s2) {
        boolean[] dummy = {false, false};
        position = length = 0;
        s1length = s1.length();
        traverseTree(root,0,0,dummy);
        if (length == 0)
            System.out.println("Strings \"" + s1 + "\" and \"" + s2
                + "\" have no common substring");
        else System.out.println("A longest common substring for \""
            + s1 + "\" and \"" + s2 + "\" is " + "\""
            + T.substring(position-length,position) + "\" of length "
            + length);
    }
}

```



**FIGURE 13.8** (continued)

```

private void traverseTree(SuffixTreeNode p, int lt, int len, boolean[] whichEdges) {
    boolean[] edges = {false, false};
    for (char i = 0; i < size; i++)
        if (p.left[i] != -1) {
            if (p.descendants[i] == null) // if it is an edge to
                if (p.left[i] <= slength) // a leaf corresponding
                    whichEdges[0] = edges[0] = true; // to s1
                else whichEdges[1] = edges[1] = true; // to s2
            else {
                traverseTree(p.descendants[i], p.left[i],
                    len+(p.right[i]-p.left[i]+1), edges);
                if (edges[0])
                    whichEdges[0] = true;
                if (edges[1])
                    whichEdges[1] = true;
            }
            if (edges[0] && edges[1] && len > length) {
                position = p.left[i];
                length = len;
            }
        }
    }
}

public void run(String s1, String s2) {
    run(s1+(char)(size+offset-2)+s2+(char)(size+offset-1));
    findLongest(s1,s2);
}

static public void main(String[] a) {
    String s1 = "ababca";
    String s2 = "cabaca";
    if (a.length == 2) {
        s1 = a[0];
        s2 = a[1];
    }
    (new LongestCommonSubstring('a','z').run(s1,s2));
}
}

```

With the suffix tree, a solution of the longest common substring for strings  $Q$  and  $R$  is now rather simple. First we need to create a suffix tree for the string  $T = Q\$R\#$  where  $\$$  and  $\#$  represent characters not used in the two strings. In this tree, no suffix ends in an internal (implicit or explicit) node. A leaf corresponding to  $Q$  is a leaf that is connected to its parent with an edge whose label includes  $\$$  (and  $\#$ ); a leaf

corresponding to  $R$  is connected to its parent with an edge whose label includes  $\#$  (but not  $\$$ ). Now the tree is traversed to find a node that meets two conditions. The node is the root of a subtree with edge labels corresponding to both strings. Moreover, the node should correspond to the longest string obtained by concatenating labels from the root to this node; this concatenated string is the sought longest substring for  $Q$  and  $R$ .

In the implementation provided in Figure 13.8, the symbols  $\$$  and  $\#$  are the characters that directly follow the range specified by the user, and are automatically attached to the two strings. For example, if the range is from  $a$  to  $z$ , and the strings are  $abccab$  and  $daababca$ , then the suffix tree is built for the string  $T = abccab\{daababca\}$ , because in the ASCII character set, characters  $\{$  and  $\}$  directly follow  $z$ .

To learn during a tree traversal whether a particular subtree contains edges corresponding to both strings (only edges that lead to leaves can provide this information), a two-cell Boolean array is associated with each node. When an edge is detected that leads to a leaf (leaves are implicit nodes), then the left index of its label is tested. If the index is not greater than the length of  $Q$ , then the leaf corresponds to a suffix of  $Q$ ; otherwise, to a suffix of  $R$ . The program maintains the maximum length of the common substring, and when it detects a node with a longer common substring and with suffixes of both strings in its subtree, the maximum length is updated, as is the position at which the substring ends.

It is clear that because the suffix tree can be created in linear time and because tree traversal can also be done in linear time, the problem of finding the longest common substrings for strings  $Q$  and  $R$  is solved in linear time  $O(|Q| + |R|)$ .

## 13.4

## EXERCISES

1. Apply the Knuth-Morris-Pratt algorithm with *next*, and then with *nextS* to  $P = bacbaaaa$  and  $T = bacbacabcacbbbacabacbabcbba$ .
2. Determine all three positions  $i, j, k$ , such that for the string *abcabdabcbabdfabcabdab-cabd* `findNextS()` executes first  $nextS[i] = nextS[j]$  and then  $nextS[j] = nextS[k]$ .
3. As mentioned in Section 13.3,  $P = a^{m-1}b$  is an example of the worst case for the partial suffix phase for `computeDelta2ByBruteForce()`. What exactly is the total number of comparisons for this phase?
4. Consider the search for a pattern in a text when the pattern is not in the text. What is the smallest number of character comparisons in this case executed by
  - a. Knuth-Morris-Pratt?
  - b. Boyer-Moore?
5. An example of the worst case for `bruteForceStringMatching()` are strings  $P = a^{m-1}b$  and  $T = a^n$ ; for `BoyerMooreSimple()` it is strings  $P = ba^{m-1}$  and  $T = a^n$ . Explain this symmetry.
6. As it stands, `BoyerMooreSimple()` shifts  $P$  by one position if a mismatched text character occurs also in  $P$  to the right of the mismatched pattern characters, for example,

```

abbaabac...
1 aabbcbac
2  aabbcbac

```

where the mismatched text character  $a$  occurs also in  $P$  to the right of the mismatched pattern character  $c$ . However, it is clear that it would be more efficient to align the mismatched text character with the same character in  $P$  that is closest to the left of the mismatched pattern character, as in

```

abbaabac...
1 aabbcbac
2   aabbcbac

```

where mismatched text character  $a$  is aligned with an  $a$  to the right of the mismatched pattern character  $c$  and closest to  $c$ . Generalize this rule and propose an implementation of *delta1* for the new rule.

7. Horspool gives a version of the Boyer-Moore algorithm that uses only one table, *delta12*, which is just like *delta1* except that for the last character of  $P$ , the entry in *delta12* is  $|P|$ , not a value  $< |P|$  as in *delta1*:

```

BoyerMooreHorspool(pattern P, text T)
  initialize all cells of delta12 to |P|;
  for j = 0 to |P|-2 // |P|-2, not |P|-1 as for delta1;
    delta12[Pj] = |P| - j - 1;
  i = |P| - 1;
  while i < |T|

```

```

j = |T| - 1;
if Ti == P|P|-1
    if T(i-|P|+1...i) is equal to P
        return match at i+|P|+1;
    i = i + delta12[Ti];
return no match;

```

Apply `BoyerMooreHorspool()` and `BoyerMooreSimple()` to  $T = abababababababba$  and  $P = aacaab$ .

8. Implement the function `period()` to be used by the `BoyerMooreGalil()` algorithm.
9. `BoyerMooreGalil()` may be less efficient than `BoyerMoore()` because for patterns with no periods it checks the condition in an `if` statement in each iteration of the outer `while` loop. Change the algorithm so that a driver function preprocesses the pattern to check for a period, and if a period is found, it calls `BoyerMoore()`; otherwise, it calls `BoyerMooreGalil()` without the `if` statement.
10. Adopt `quickSearch()` so that it performs matching right to left.
11. Show an example for the case when `BoyerMooreSimple()` provides better shift than Sunday's `quickSearch()`.
12. The `shiftAnd()` algorithm performs four bitwise operations in each iteration of the last `for` loop. The number can be reduced to three if the roles of bits are reversed, as it is done originally by Baeza-Yates and Gonnet (1992); for example, in *charactersInP*, 0 represents the positions at which a character occurs in the pattern. With this bit role reversal, the assignment

```
state = ((state << 1) | 1) & charactersInP[T[i]];
```

can be changed to

```
state = (state << 1) | charactersInP[T[i]];
```

Write an algorithm `shiftOr()` by making all the necessary changes in `shiftAnd()` including the indicated modifications.

13. What is the maximum number of keywords in a set  $output(state)$  for some  $state$ ?
14. Draw Ukkonen suffix tries for
  - a. *aaaa*
  - b. *aabb*
  - c. *abba*
  - d. *abcd*
  - e. *baaa*
  - f. *abaa*
  - g. *aaba*
  - h. *aaab*

15. How can the number of occurrences of pattern  $P$  in text  $T$  be determined using a suffix tree for  $T$ ?
16. How can a suffix tree be used to determine all substrings of  $Q$  that are not substrings of  $R$ ?
17. The problem of string matching with  $k$  differences can be solved by simple modification of the Wagner-Fischer algorithm. This is accomplished by having the entries in the edit distance table represent the minimum distance between prefix  $Q(0 \dots i)$  and any suffix of  $R(0 \dots j)$  (Sellers, 1980). This is done by defining the entries in the matrix with the same recurrence relation as  $D(i, j) = \min(D(i-1, j) + 1, D(i, j-1) + 1, D(i-1, j-1) + c(i, j))$ , the same boundary condition for column 0:  $D(i, 0) = i$ , but a different condition for row 0:  $D(0, j) = 0$  to indicate that an occurrence can start at any position of  $R$ . In the resulting edit table, any number in the last row that is not greater than  $k$  indicates a position in  $R$  of the end of a substring of  $R$  that has at most  $k$  differences with  $Q$ . Build such an edit table for strings  $Q = abcabb$  and  $R = acbdcbbdd$ .

**13.5****PROGRAMMING ASSIGNMENTS**

1. Write a program that implements and tests the brute force algorithm to create a suffix tree.
2. Extend the program from the case study so that it can find all substrings of length greater than  $k$  common to both strings.
3. Write a program that uses a suffix tree to find the longest repeated substring in a string  $s$ . After creating the tree, perform a tree traversal and find a node that has only leaf descendants and a longest substring determined by the path from the root to this node. Consider extending your program in one of three ways:
  - a. Find only nonoverlapping substrings.
  - b. Find the longest substring repeated at least  $k$  times.
  - c. Find all repeated substrings longer than  $m$  characters.
4. One constructor of the `UkkonenSuffixTree` class allows for using a range of characters to save space for the three arrays used in each node. Sometimes, however, only a few nonconsecutive characters are used in the text, for example, letters  $A$ ,  $C$ ,  $G$ , and  $T$  in DNA sequences. In this situation, the constructor `UkkonenSuffixTree('A', 'T')` can be used, which would create three arrays of `'T' - 'A' + 1 = 20` cells each, although only four cells would be used in each array. Modify the program so that it accepts a set of characters to be used—as with the string “ACGT” in our example—and operates on arrays of the size equal to the number of characters used in the set.


**BIBLIOGRAPHY**

- Aho, Alfred V., and Corasick, Margaret J., “Efficient String Matching: An Aid to Bibliographic Search,” *Communications of the ACM* 18 (1975), 333–340.
- Baeza-Yates, Ricardo, and Gonnet, Gaston H., “A New Approach to Text Searching,” *Communications of the ACM* 35 (1992), No. 10, 74–82.
- Baeza-Yates, Ricardo A., and Perleberg, Chris H., “Fast and Practical Approximate String Matching,” in A. Apostolico, M. Crochemore, Z. Galil, U. Manber (eds.), *Combinatorial Pattern Matching*, Berlin: Springer (1992), 185–192.
- Barth, Gerhard, “Relating the Average-Case Costs of the Brute-Force and Knuth-Morris-Pratt Matching Algorithm,” in A. Apostolico and Z. Galil (eds.), *Combinatorial Algorithms on Words*. Berlin: Springer (1985), 45–58.
- Boyer, Robert S., and Moore, J. Strother, “A Fast Searching Algorithm,” *Communications of the ACM* 20 (1977), 762–772.
- Cole, Richard, “Right Bounds on the Complexity of the Boyer-Moore String Matching Algorithm,” *SIAM Journal on Computing* 23 (1994), 1075–1091.
- Drozdek, Adam, “Hirschberg’s Algorithm for Approximate Matching,” *Computer Science* 4 (2002), 91–100.
- Galil, Zvi, “On Improving the Worst Case Running Time of the Boyer-Moore String Matching,” *Communications of the ACM* 22 (1979), 505–508.
- Guibas, Leo J., and Odlyzko, Andrew M., “A New Proof of the Linearity of the Boyer-Moore String Searching Algorithm,” *SIAM Journal on Computing* 9 (1980), 672–682.
- Hancart, Christophe, “Un Analyse en Moyenne de l’Algorithm de Morris et Pratt et ses Raffinements,” in D. Krob (ed.), *Actes des deuxièmes journées franco-belges*, Rouen: Université de Rouen (1992), 99–110.
- Horspool, R. Nigel, “Practical Fast Searching in Strings,” *Software—Practice and Experience* 10 (1980), 501–506.
- Hunt, James W., and Szymanski, Thomas G., “A Fast Algorithm for Computing Longest Common Subsequences,” *Communications of the ACM* 20 (1977), 350–353.
- Knuth, Donald E., Morris, James H., and Pratt, Vaughan R., “Fast Pattern Matching in Strings,” *SIAM Journal on Computing* 6 (1977), 323–350.
- Levenshtein, V. I., “Binary Codes Capable of Correcting Deletions, Insertions, and Reversals,” *Cybernetics and Control Theory* 10 (1966), 707–710, translation of a paper from *Doklady Akademii Nauk SSSR* 163 (1965), 845–848.
- Manber, Udi, and Myers, Gene, “Suffix Arrays: A New Method for On-line String Searches,” *SIAM Journal on Computing* 22 (1993), 935–948.
- Pirklbauer, Klaus, “A Study of Pattern-Matching Algorithms,” *Structured Programming* 13 (1992), 89–98.
- Sellers, Peter H., “The Theory and Computation of Evolutionary Distances: Pattern Recognition,” *Journal of Algorithms* 1 (1980), 359–373.

Smith, P. D., "Experiments with a Very Fast Substring Search Algorithm," *Software—Practice and Experience* 21 (1991), 1065–1074.

Sunday, Daniel M., "A Very Fast Substring Searching Algorithm," *Communications of the ACM* 33 (1990), 132–142.

Thompson, Ken, "Regular Expression Search Algorithm," *Communications of the ACM* 6 (1968), 419–422.

Ukkonen, Esko, "On-line Construction of Suffix Trees," *Algorithmica* 14 (1995), 249–260.

Ukkonen, Esko, and Wood, Derick, "Approximate String Matching with Suffix Automata," *Algorithmica* 10 (1993), 353–364.

Wagner, Richard A., and Fischer, M. J., "The String-to-String Correction Problem," *Journal of the ACM* 21 (1974), 168–173.

Wu, Sun, and Manber, Udi, "Fast Text Searching Allowing Errors," *Communications of the ACM* 35 (1992), No. 10, 83–91.



# Computing Big-O

## A.1 HARMONIC SERIES

In some computations in this book, the convention  $H_n$  is used for harmonic numbers. The *harmonic numbers*  $H_n$  are defined as the sums of the *harmonic series*, a series of the form  $\sum_{i=1}^n \frac{1}{i}$ . This is a very important series for the analysis of searching and sorting algorithms. It is proved that

$$H_n = \ln n + \gamma + \frac{1}{2n} - \frac{1}{12n^2} + \frac{1}{120n^4} - \epsilon$$

where  $n \geq 1$ ,  $0 < \epsilon < \frac{1}{256n^6}$ , and Euler's constant  $\gamma \approx 0.5772$ . This approximation, however, is very unwieldy and, in the context of our analyses, not necessary in this form.  $H_n$ 's largest term is almost always  $\ln n$ , the only increasing term in  $H_n$ . Thus,  $H_n$  can be referred to as  $O(\ln n)$ .

## A.2 APPROXIMATION OF THE FUNCTION LG(N!)

The roughest approximation of  $\lg(n!)$  can be obtained by observing that each number in the product  $n! = 1 \cdot 2 \cdot \dots \cdot (n-1) \cdot n$  is less than or equal to  $n$ . Thus,  $n! \leq n^n$  (only for  $n = 1$ ,  $n = n^n$ ), which implies that  $\lg(n!) < \lg(n^n) = n \lg n$ —that is,  $n \lg n$  is an upper bound of  $\lg(n!)$ —and that  $\lg(n!)$  is  $O(n \lg n)$ .

Let us also find a lower bound for  $\lg(n!)$ . If the elements of the product  $n!$  are grouped appropriately, as in

$$P_{n_i} = (1 \cdot n)(2 \cdot (n-1))(3 \cdot (n-2)) \dots (i \cdot (n-i+1)) \dots, \text{ for } 1 \leq i \leq \frac{n}{2}$$

then it can be noted that there are  $\frac{n}{2}$  such terms and  $n! = P_{n_i}$  for even  $ns$  or  $\frac{n+1}{2}$  terms and  $n! = P_{n_i} \frac{n+1}{2}$  for odd  $ns$ . We claim that each term of  $P_{n_i}$  is not less than  $n$ , or

$$1 \leq i \leq \frac{n}{2} \Rightarrow i(n-i+1) \geq n$$



In fact, this holds because

$$\frac{n}{2} \geq i = \frac{i(i-1)}{i-1} \Rightarrow i(n-2i+2) \geq n$$

and, as can easily be checked,

$$i \geq 1 \Rightarrow (n-2i+2) \leq (n-i+1)$$

We have shown that  $n! = P_n \geq n^{\frac{n}{2}}$ , which means that  $\lg(n!) \geq \frac{n}{2} \lg n$ . This assumes that  $n$  is even. If  $n$  is odd, it has to be raised to the power of  $\frac{n+1}{2}$ , which introduces no substantial change.

The number  $\lg(n!)$  has been estimated using the lower and upper bounds of this function, and the result is  $\frac{n}{2} \lg n \leq \lg(n!) \leq n \lg n$ . To approximate  $\lg(n!)$ , lower and upper bounds have been used that both grow at the rate of  $n \lg n$ . This implies that  $\lg(n!)$  grows at the same rate as  $n \lg n$  or that  $\lg(n!)$  is not only  $O(n \lg n)$ , but also  $\Theta(n \lg n)$ . In other words, any sorting algorithm using comparisons on an array of size  $n$  must make at least  $O(n \lg n)$  comparisons in the worst case. Thus, the function  $n \lg n$  approximates the optimal number of comparisons in the worst case.

However, this result seems unsatisfactory because it refers only to the worst case, and such a case occurs only occasionally. Most of the time, average cases with random orderings of data occur. Is the number of comparisons really better in such cases, and is it a reasonable assumption that the number of comparisons in the average case can be better than  $O(n \lg n)$ ? Unfortunately, this conjecture has to be rejected, and the following computations prove it false.

Our conjecture is that, in any binary tree with  $m$  leaves and two children for each nonterminal node, the average number of arcs leading from the root to a leaf is greater than or equal to  $\lg m$ .

For  $m = 2$ ,  $\lg m = 1$ , if there is just a root with two leaves, then there is only one arc to every one of them. Assume that the proposition holds for a certain  $m \geq 2$  and that

$$\text{Ave}_m = \frac{p_1 + \dots + p_m}{m} \geq \lg m$$

where each  $p_i$  is a path (the number of arcs) from the root to node  $i$ . Now consider a randomly chosen leaf with two children about to be attached. This leaf converted to a nonterminal node has an index  $m$  (this index is chosen to simplify the notation) and a path from the root to the node  $m$  is  $p_m$ . After adding two new leaves, the total number of leaves is incremented by one and the path for both these appended leaves is  $p_{m+1} = p_m + 1$ . Is it now true that

$$\text{Ave}_{m+1} = \frac{p_1 + \dots + p_{m-1} + 2p_m + 2}{m+1} \geq \lg(m+1)$$

From the definition of  $\text{Ave}_m$  and  $\text{Ave}_{m+1}$  and from the fact that  $p_m = \text{Ave}_m$  (because leaf  $m$  was chosen randomly),

$$(m+1)\text{Ave}_{m+1} = m\text{Ave}_m + p_m + 2 = (m+1)\text{Ave}_m + 2$$

Is it now true that

$$(m+1)\text{Ave}_{m+1} \geq (m+1) \lg(m+1)$$

or

$$(m + 1)\text{Ave}_{m+1} = (m + 1)\text{Ave}_m + 2 \geq (m + 1) \lg m + 2 \geq (m + 1) \lg(m + 1)$$

This is transformed into

$$2 \geq \lg \left( \frac{m+1}{m} \right)^{m+1} = \lg \left( 1 + \frac{1}{m} \right) + \lg \left( 1 + \frac{1}{m} \right)^m \rightarrow \lg 1 + \lg e = \lg e \approx 1.44$$

which is true for any  $m \geq 1$ . This completes the proof of the conjecture.

This proves that for a randomly chosen leaf of an  $m$ -leaf decision tree, the reasonable expectation is that the path from the root to the leaf is not less than  $\lg m$ . The number of leaves in such a tree is not less than  $n!$ , which is the number of all possible orderings of an  $n$ -element array. If  $m \geq n!$ , then  $\lg m \geq \lg(n!)$ . That is the unfortunate result indicating that an average case also requires, like the worst case,  $\lg(n!)$  comparisons (length of path = number of comparisons), and as already estimated,  $\lg(n!)$  is  $O(n \lg n)$ . This is also the best that can be expected in average cases.

### A.3

## BIG-O FOR AVERAGE CASE OF QUICKSORT

Let  $C(n)$  be the number of comparisons required to sort an array of  $n$  cells. Because the arrays of size 1 and 0 are not partitioned,  $C(0) = C(1) = 0$ . Assuming a random ordering of an  $n$ -element array, any element can be chosen as the bound; the probability that any element will become the bound is the same for all elements. With  $C(i - 1)$  and  $C(n - i)$  denoting the numbers of the comparisons required to sort the two subarrays, there are

$$C(n) = n - 1 + \frac{1}{n} \sum_{i=1}^n (C(i - 1) + C(n - i)), \text{ for } n \geq 2$$

comparisons, where  $n - 1$  is the number of comparisons in the partition of the array of size  $n$ . First, some simplification can be done:

$$\begin{aligned} C(n) &= n - 1 + \frac{1}{n} \left( \sum_{i=1}^n C(i - 1) + \sum_{i=1}^n C(n - i) \right) \\ &= n - 1 + \frac{1}{n} \left( \sum_{i=1}^n C(i - 1) + \sum_{j=1}^n C(j - 1) \right) \\ &= n - 1 + \frac{2}{n} \sum_{i=0}^{n-1} C(i) \end{aligned}$$

or

$$nC(n) = n(n - 1) = 2 \sum_{i=0}^{n-1} C(i)$$

To solve the equation, the summation operator is removed first. To that end, the last equation is subtracted from an equation obtained from it,

$$(n + 1)C(n + 1) = (n + 1)n + 2 \sum_{i=0}^n C(i)$$

resulting in

$$(n+1)C(n+1) - nC(n) = (n+1)n - n(n-1) + 2\left(\sum_{i=0}^n C(i) - \sum_{i=0}^{n-1} C(i)\right) = 2C(n) + 2n$$

from which

$$\frac{C(n+1)}{n+2} = \frac{C(n)}{n+1} + \frac{2n}{(n+1)(n+2)} = \frac{C(n)}{n+1} + \frac{4}{n+2} - \frac{2}{n+1}$$

This equation can be expanded, which gives

$$\frac{C(2)}{3} = \frac{C(1)}{2} + \frac{4}{3} - \frac{2}{2} = \frac{4}{3} - \frac{2}{2}$$

$$\frac{C(3)}{4} = \frac{C(2)}{3} + \frac{4}{4} - \frac{2}{3}$$

$$\frac{C(4)}{5} = \frac{C(3)}{4} + \frac{4}{5} - \frac{2}{4}$$

⋮

$$\frac{C(n)}{n+1} = \frac{C(n-1)}{n} + \frac{4}{n+1} - \frac{2}{n}$$

$$\frac{C(n+1)}{n+2} = \frac{C(n)}{n+1} + \frac{4}{n+2} - \frac{2}{n+1}$$

from which

$$\begin{aligned} \frac{C(n+1)}{n+2} &= \left(\frac{4}{3} - \frac{2}{2}\right) + \left(\frac{4}{4} - \frac{2}{3}\right) + \left(\frac{4}{5} - \frac{2}{4}\right) + \cdots + \left(\frac{4}{n+1} - \frac{2}{n}\right) \\ &\quad + \left(\frac{4}{n+2} - \frac{2}{n+1}\right) \\ &= -\frac{2}{2} + \frac{2}{3} + \frac{2}{4} + \frac{2}{5} + \cdots + \frac{2}{n} + \frac{2}{n+1} + \frac{4}{n+2} \\ &= -4 + 2H_{n+2} + \frac{2}{n+2} \end{aligned}$$

Note that  $H_{n+2}$  is a harmonic number. Using an approximation for this number (see Section A.1)

$$\begin{aligned} C(n) &= (n+1)\left(-4 + 2H_{n+1} + \frac{2}{n+1}\right) \\ &= (n+1)\left(-4 + 2O(\ln n) + \frac{2}{n+1}\right) \\ &= O(n \lg n) \end{aligned}$$

## A.4

AVERAGE PATH LENGTH IN  
A RANDOM BINARY TREE

In Chapter 6, an approximation is used for the average path length in a randomly created binary search tree. Assuming that

$$P_n(i) = \frac{(i-1)(P_{i-1} + 1) + (n-i)(P_{n-i} + 1)}{n}$$

this approximation is given by this recurrence relation

$$\begin{aligned} P_1 &= 0 \\ P_n &= \frac{1}{n} \sum_{i=1}^n P_n(i) = \frac{1}{n^2} \sum_{i=1}^n ((i-1)(P_{i-1} + 1) + (n-i)(P_{n-i} + 1)) \\ P_n &= \frac{2}{n^2} \sum_{i=1}^{n-1} i(P_i + 1) \end{aligned} \quad (1)$$

From this, we also have

$$P_{n-1} = \frac{2}{(n-1)^2} \sum_{i=1}^{n-2} i(P_i + 1) \quad (2)$$

After multiplying this equation by  $\frac{(n-1)^2}{n^2}$  and subtracting the resulting equation from (1), we have

$$P_n = P_{n-1} \frac{(n-1)^2}{n^2} + \frac{2(n-1)(P_{n-1} + 1)}{n^2} = \frac{(n-1)}{n^2} ((n+1)P_{n-1} + 2)$$

After successive applications of this formula to each  $P_{n-p}$ , we have

$$\begin{aligned} P_n &= \frac{n-1}{n^2} \left( (n+1) \frac{(n-2)}{(n-1)^2} \left( n \frac{(n-3)}{(n-2)^2} \left( (n-1) \frac{(n-4)}{(n-3)^2} \left( \dots \frac{1}{2^2} (3P_1 + 2) \dots \right) + 2 \right) + 2 \right) + 2 \right) \\ P_n &= 2 \left( \frac{n-1}{n^2} + \frac{(n+1)(n-2)}{(n-1)n^2} + \frac{(n+1)(n-3)}{n(n-1)(n-2)} + \frac{(n+1)(n-4)}{n(n-2)(n-3)} + \dots + \frac{n+1}{2 \cdot 3n} \right) \\ P_n &= 2 \left( \frac{n+1}{n} \right) \sum_{i=1}^{n-1} \frac{n-i}{(n-i+1)(n-i+2)} = 2 \left( \frac{n+1}{n} \right) \sum_{i=1}^{n-1} \left( \frac{2}{n-i+2} - \frac{1}{n-i+1} \right) \\ P_n &= 2 \left( \frac{n+1}{n} \right) \frac{2}{n+1} + 2 \left( \frac{n+1}{n} \right) \left( \sum_{i=1}^n \frac{1}{i} - 2 \right) = 2 \left( \frac{n+1}{n} \right) H_n - 4 \end{aligned}$$

So,  $P_n$  is  $O(2 \ln n)$ .

## A.5 THE NUMBER OF NODES IN AN AVL TREE

The minimum number of nodes in an AVL tree is determined by the recurrence equation

$$AVL_h = AVL_{h-1} + AVL_{h-2} + 1$$

with  $AVL_0 = 0$  and  $AVL_1 = 1$ . A comparison of this equation with the definition of the Fibonacci sequence (Section 5.8) indicates that  $AVL_h = F_{h+2} - 1$ ; that is, using the de Moivre formula

$$F_h = \frac{1}{\sqrt{5}} \left( \frac{1 + \sqrt{5}}{2} \right)^h - \frac{1}{\sqrt{5}} \left( \frac{1 - \sqrt{5}}{2} \right)^h$$

we obtain

$$AVL_h = \frac{1}{\sqrt{5}} \left( \frac{1 + \sqrt{5}}{2} \right)^{h+2} - \frac{1}{\sqrt{5}} \left( \frac{1 - \sqrt{5}}{2} \right)^{h+2} - 1$$

Because  $\left| \frac{1}{2}(1 - \sqrt{5}) \right| \approx 0.618034$ , the second term in this equation quickly decreases with the increase of  $h$  and has the maximum value 0.17082 for  $h = 0$ ; therefore,

$$AVL_h \geq \frac{1}{\sqrt{5}} \left( \frac{1 + \sqrt{5}}{2} \right)^{h+2} - 0.17082 - 1 \geq \frac{1}{\sqrt{5}} \left( \frac{1 + \sqrt{5}}{2} \right)^{h+2} - 2$$

or

$$AVL_h + 2 \geq \frac{1}{\sqrt{5}} \left( \frac{1 + \sqrt{5}}{2} \right)^{h+2}$$

Taking  $\lg$  of both sides renders

$$\lg(AVL_h + 2) \geq \lg \frac{1}{\sqrt{5}} + 2 \lg \left( \frac{1 + \sqrt{5}}{2} \right) + h \lg \left( \frac{1 + \sqrt{5}}{2} \right) \approx 0.22787 + 0.69424h$$

from which we obtain an upper bound on  $h$

$$h \leq 1.44042 \lg(AVL_h + 2) - 0.32824 \leq 1.44042 \lg(AVL_h + 2)$$

and thus

$$\lg(AVL_h + 1) \leq h < 1.44042 \lg(AVL_h + 2) - 0.32824.$$

# B

# NP-Completeness

## B.1 COOK'S THEOREM

A Turing machine is a device that reads and manipulates symbols in the cells of an infinite tape. It processes symbols by using a head that can move in either direction. More formally, a *Turing machine*  $M$  is defined as a tuple

$$M = (Q, \Sigma, \Gamma, \delta, q_0, F)$$

where

$Q = \{q_0, q_1, \dots, q_n\}$  is a finite set of states.

$\Sigma \subset \Gamma - \{\#\}$  is a finite input alphabet.

$\Gamma = \{a_0, a_1, \dots, a_m\}$ ,  $a_0 = \text{blank \#}$ , is a finite tape alphabet.

$\delta: Q \times \Gamma \rightarrow Q \times \Gamma \times \{-1, +1\}$  is a transition function.

$q_0$  is a start state.

$F \subseteq Q$  is a set of final states.

The machine accepts or rejects any string of symbols built from alphabet  $\Sigma$ . In this way, a Turing machine defines a language that is a set of all strings acceptable by the machine.

The following is a Turing machine that computes the function sign for binary integers (possibly beginning with redundant 0s), that is

$$\text{sgn}(n) = \begin{cases} 0 & \text{if } n = 0, \\ 1 & \text{if } x > 0 \end{cases}$$

For this machine,  $Q = \{q_0, q_1, q_2, q_3\}$ ,  $\Sigma = \{0, 1, \#\}$ ,  $\Gamma = \{0, 1\}$ ,  $F = \{q_3\}$ , and the transition function  $\delta$  is given by the following table:

$\delta$	0	1	#
$q_0$	$(q_0, 0, +1)$	$(q_1, 1, +1)$	$(q_2, 0, -1)$
$q_1$	$(q_1, 0, +1)$	$(q_1, 1, +1)$	$(q_2, 1, -1)$
$q_2$	$(q_3, \#, +1)$	$(q_3, \#, +1)$	

For the binary representation of number 2 with one redundant 0, 010, the changes of states are indicated by the following modifications of the tape.

Initial situation:

↓

0	1	0	#	#	...
---	---	---	---	---	-----

Step 0. Because  $\delta(q_0, 0) = (q_0, 0, +1)$ —which reads: From state  $q_0$  and 0 in the current cell, leave 0 in this cell, go to the cell to its right and to state  $q_0$ —the next situation is

↓

0	1	0	#	#	...
---	---	---	---	---	-----

Step 1. Because  $\delta(q_0, 1) = (q_1, 1, +1)$ , then

↓

0	1	0	#	#	...
---	---	---	---	---	-----

Step 2. Because  $\delta(q_1, 0) = (q_1, 0, +1)$ , we have

↓

0	1	0	#	#	...
---	---	---	---	---	-----

Step 3. Form  $\delta(q_1, \#) = (q_2, 1, -1)$ , the next configuration is

↓

0	1	0	1	#	...
---	---	---	---	---	-----

Step 4. On account of the transition  $\delta(q_2, 0) = (q_3, \#, +1)$ ,

↓

0	1	#	1	#	...
---	---	---	---	---	-----

In this example, the head goes to the right when it encounters 0 or 1 in a cell. When it encounters a blank, it writes 1 over it, goes to the left, writes a blank over it, and the machine finishes execution. When an input is all 0s, then the head ignores these zeros by moving to the right until it finds a blank. Then it writes 0 over it, moves to the left, writes a blank over it, and finishes execution.

A *nondeterministic Turing machine* has a finite number of choices for the next move and it is not determined which move should be made.

**Theorem** (Cook). Satisfiability problem is NP-complete.

**Proof:** A nondeterministic Turing machine  $M$  is assumed to be polynomially time bounded; that is, a valid computation sequence on input  $I$  takes  $N = p(|I|)$  steps, where  $p(|I|)$  is a polynomial in the length  $|I|$  of input  $I$ , and can use at most  $N$  tape cells.  $M$  has an infinite tape extended in one direction only, with cells  $0, 1, \dots$

To show that every NP problem is polynomially transformable to a satisfiability problem, a mapping is constructed from any input  $I$  of an arbitrary nondeterministic Turing machine  $M$  to an instance  $r(I)$  of a satisfiability problem. The mapping  $r$  is so constructed that the Boolean formula  $r(I)$  is satisfiable iff  $M$  accepts  $I$ . Thus, the reduction  $r(I)$  models (simulates) a computation on  $M$  for an input  $I$ .

There are three types of logical (Boolean) variables (proposition symbols) used by function  $r$  to construct  $r(I)$ :

- $P(i,s,t)$ <sup>1</sup> is true iff at step  $t$ , tape cell  $s$  contains symbol  $a_i$ .
- $Q(j,t)$  is true iff at step  $t$ ,  $M$  is in state  $q_j$ .
- $S(s,t)$  is true iff at step  $t$ , cell  $s$  is scanned by  $M$ 's head.

where  $0 \leq i \leq m$ ,  $0 \leq j \leq n$ ,  $0 \leq s, t \leq N$ . With these definitions, computations of  $M$  on  $I$  can be represented as assignments of truth values to sequences of Boolean variables. With these variables, Boolean clauses can be written that describe various situations in  $M$  during computation on  $I$ . The conjunction of these clauses that represent the history of computation of  $M$  on  $I$  is the formula  $r(I)$ .

The statement  $r(I)$  is a conjunction of eight groups of statements, each group used to enforce one requirement that  $r(I)$  models a computation on  $M$ .

Let  $\bigwedge_{0 \leq i \leq m} Q(i,t) = Q(0,t) \wedge Q(1,t) \wedge \dots \wedge Q(m,t)$ , and similarly for the alternative.

1. At each step  $t$ , each tape cell contains exactly one symbol

$$\bigwedge_{0 \leq s, t \leq N} (\bigvee_{0 \leq i \leq m} P(i,s,t) \wedge \bigwedge_{0 \leq i < i' \leq m} (\neg P(i,s,t) \vee \neg P(i',s,t)))$$

This condition states that at each step  $t$  and each cell  $s$ ,  $s$  includes at least a symbol  $a_i$ ,  $P(i,s,t)$ , but, at the same time, no more than one symbol; that is,  $\neg(P(i,s',t) \wedge P(i,s,t))$ , or, by de Morgan's law,  $\neg P(i,s',t) \vee \neg P(i,s,t)$  for two different symbols  $a_i$  and  $a_{i'}$ .

2. At each step  $t$ ,  $M$  is in exactly one state  $q_j$

$$\bigwedge_{0 \leq t \leq N} (\bigvee_{0 \leq j \leq n} Q(j,t) \wedge \bigwedge_{0 \leq j < j' \leq n} (\neg Q(j,t) \vee \neg Q(j',t)))$$

3. At each step  $t$ ,  $M$  is scanning exactly one tape cell  $s$

$$\bigwedge_{0 \leq t \leq N} (\bigvee_{0 \leq s \leq N} S(s,t) \wedge \bigwedge_{0 \leq s < s' \leq N} (\neg S(s,t) \vee \neg S(s',t)))$$

4. The computation process begins in state  $q_0$  with input symbols  $I = a_{s_1} a_{s_2} \dots a_{s_{|I|}}$  occupying  $0, \dots, |I| - 1$  leftmost cells of the tape, with the remaining cells filled with blank characters #. This initial situation is represented by this formula:

<sup>1</sup>The notation  $P_{i,s,t}$  can also be used.



$$Q(0,0) \wedge S(0,0) \wedge P(a_{s_1},0,0) \wedge \dots \wedge P(a_{s_{|I|}},|I| - 1,0) \wedge P(\#,|I|,0) \wedge \dots \wedge P(\#,N,0)$$

5. The permitted transitions during computation are given by the transition function  $\delta(q_j, a_i) = (q_{j'}, d) \in \{-1, +1\}$ . Using this function it has to be stated now that in each step the values of functions  $P$ ,  $Q$ , and  $S$  are properly updated. For example, for each cell  $s$  and step  $t$ , if  $M$  is in state  $q_j$  scanning symbol  $a_p$ , then in the next step it is in state  $q_{j'}$ , as specified by the function  $\delta$ :

$$\bigwedge_{0 \leq t < N} \bigwedge_{0 \leq s \leq N} (P(i,s,t) \wedge Q(j,t) \wedge S(s,t)) \Rightarrow Q(j',t+1)$$

that is, by the definition of implication ( $\alpha \Rightarrow \beta = \neg\alpha \vee \beta$ ) and by de Morgan's law:

$$\bigwedge_{0 \leq t < N} \bigwedge_{0 \leq s \leq N} (\neg P(i,s,t) \vee \neg Q(j,t) \vee \neg S(s,t) \vee Q(j',t+1))$$

After we generalize it for all steps and all cells, we obtain the requirement

$$\bigwedge_{0 \leq t < N} \bigwedge_{0 \leq s \leq N} \bigwedge_{0 \leq i \leq m} \bigwedge_{0 \leq j \leq n} (\neg P(i,s,t) \vee \neg Q(j,t) \vee \neg S(s,t) \vee Q(j',t+1))$$

where “for all” should be qualified to range over  $i$  and  $j$  for which  $\delta(q_j, a_i)$  is defined. If  $M$  is in a halting state, then in the next step it remains in that state, in the same cell, and the symbol in the cell remains the same. If  $M$  is in cell 0 and the next step would require going to the left, thereby sliding off the tape, then  $M$  halts; that is, it remains in the same state, in the same cell with the same symbol in the cell.

6. Similarly, we obtain permitted updates for  $P$ :

$$\bigwedge_{0 \leq t < N} \bigwedge_{0 \leq s \leq N} \bigwedge_{0 \leq i \leq m} \bigwedge_{0 \leq j \leq n} (\neg P(i,s,t) \vee \neg Q(j,t) \vee \neg S(s,t) \vee P(i',s,t+1))$$

7. and for  $S$ :

$$\bigwedge_{0 \leq t < N} \bigwedge_{0 \leq s \leq N} \bigwedge_{0 \leq i \leq m} \bigwedge_{0 \leq j \leq n} (\neg P(i,s,t) \vee \neg Q(j,t) \vee \neg S(s,t) \vee S(s+d,t+1))$$

8. The machine finally reaches an accepting state, which is reflected in the simple formula

$$\bigvee_{\{j: q_j \in F\}} Q(j,N) \quad \blacksquare$$

If input  $I$  belongs to language for which  $M$  was constructed, then  $M$  reaches the accepting state when processing  $I$ . This processing imposes truth value assignments that satisfy all the clauses from groups 1 through 8. Also, any assignment of truth values to statements 1–8 that satisfies them describes a computation that ends in an accepting state. Therefore,  $r(I)$  is satisfiable iff input  $I$  is an element of language recognizable by  $M$ .

The construction process of  $r(I)$  indicates that  $r(I)$  can be constructed in polynomial time.

For the Turing machine  $M$  defined earlier, with  $N = 4$ ,  $m = 2$ , and  $n = 3$ , the statement  $r(010)$  is the following conjunction of alternatives:

$$\begin{aligned} & (P(0,0,0) \vee P(1,0,0) \vee P(2,0,0)) \wedge (\neg P(0,0,0) \vee \neg P(1,0,0)) \wedge (\neg P(0,0,0) \vee \neg P(2,0,0)) \wedge (\neg P(1,0,0) \vee \neg P(2,0,0)) \wedge \\ & (P(0,0,1) \vee P(1,0,1) \vee P(2,0,1)) \wedge (\neg P(0,0,1) \vee \neg P(1,0,1)) \wedge (\neg P(0,0,1) \vee \neg P(2,0,1)) \wedge (\neg P(1,0,1) \vee \neg P(2,0,1)) \wedge \\ & (P(0,0,2) \vee P(1,0,2) \vee P(2,0,2)) \wedge (\neg P(0,0,2) \vee \neg P(1,0,2)) \wedge (\neg P(0,0,2) \vee \neg P(2,0,2)) \wedge (\neg P(1,0,2) \vee \neg P(2,0,2)) \wedge \\ & (P(0,0,3) \vee P(1,0,3) \vee P(2,0,3)) \wedge (\neg P(0,0,3) \vee \neg P(1,0,3)) \wedge (\neg P(0,0,3) \vee \neg P(2,0,3)) \wedge (\neg P(1,0,3) \vee \neg P(2,0,3)) \wedge \\ & (P(0,0,4) \vee P(1,0,4) \vee P(2,0,4)) \wedge (\neg P(0,0,4) \vee \neg P(1,0,4)) \wedge (\neg P(0,0,4) \vee \neg P(2,0,4)) \vee (\neg P(1,0,4) \vee P(2,0,4)) \wedge \\ & (P(0,1,0) \vee P(1,1,0) \vee P(2,1,0)) \wedge (\neg P(0,1,0) \vee \neg P(1,1,0)) \wedge (\neg P(0,1,0) \vee \neg P(2,1,0)) \wedge (\neg P(1,1,0) \vee \neg P(2,1,0)) \wedge \\ & (P(0,1,1) \vee P(1,1,1) \vee P(2,1,1)) \wedge (\neg P(0,1,1) \vee \neg P(1,1,1)) \wedge (\neg P(0,1,1) \vee \neg P(2,1,1)) \wedge (\neg P(1,1,1) \vee \neg P(2,1,1)) \wedge \end{aligned}$$

$$\begin{aligned}
& (P(0,1,2) \vee P(1,1,2) \vee P(2,1,2)) \wedge (\neg P(0,1,2) \vee \neg P(1,1,2)) \wedge (\neg P(0,1,2) \vee \neg P(2,1,2)) \wedge (\neg P(1,1,2) \vee \neg P(2,1,2)) \wedge \\
& (P(0,1,3) \vee P(1,1,3) \vee P(2,1,3)) \wedge (\neg P(0,1,3) \vee \neg P(1,1,3)) \wedge (\neg P(0,1,3) \vee \neg P(2,1,3)) \wedge (\neg P(1,1,3) \vee \neg P(2,1,3)) \wedge \\
& (P(0,1,4) \vee P(1,1,4) \vee P(2,1,4)) \wedge (\neg P(0,1,4) \vee \neg P(1,1,4)) \wedge (\neg P(0,1,4) \vee \neg P(2,1,4)) \wedge (\neg P(1,1,4) \vee \neg P(2,1,4)) \wedge \\
& (P(0,2,0) \vee P(1,2,0) \vee P(2,2,0)) \wedge (\neg P(0,2,0) \vee \neg P(1,2,0)) \wedge (\neg P(0,2,0) \vee \neg P(2,2,0)) \wedge (\neg P(1,2,0) \vee \neg P(2,2,0)) \wedge \\
& (P(0,2,1) \vee P(1,2,1) \vee P(2,2,1)) \wedge (\neg P(0,2,1) \vee \neg P(1,2,1)) \wedge (\neg P(0,2,1) \vee \neg P(2,2,1)) \wedge (\neg P(1,2,1) \vee \neg P(2,2,1)) \wedge \\
& (P(0,2,2) \vee P(1,2,2) \vee P(2,2,2)) \wedge (\neg P(0,2,2) \vee \neg P(1,2,2)) \wedge (\neg P(0,2,2) \vee \neg P(2,2,2)) \wedge (\neg P(1,2,2) \vee \neg P(2,2,2)) \wedge \\
& (P(0,2,3) \vee P(1,2,3) \vee P(2,2,3)) \wedge (\neg P(0,2,3) \vee \neg P(1,2,3)) \wedge (\neg P(0,2,3) \vee \neg P(2,2,3)) \wedge (\neg P(1,2,3) \vee \neg P(2,2,3)) \wedge \\
& (P(0,2,4) \vee P(1,2,4) \vee P(2,2,4)) \wedge (\neg P(0,2,4) \vee \neg P(1,2,4)) \wedge (\neg P(0,2,4) \vee \neg P(2,2,4)) \wedge (\neg P(1,2,4) \vee \neg P(2,2,4)) \wedge \\
& (P(0,3,0) \vee P(1,3,0) \vee P(2,3,0)) \wedge (\neg P(0,3,0) \vee \neg P(1,3,0)) \wedge (\neg P(0,3,0) \vee \neg P(2,3,0)) \wedge (\neg P(1,3,0) \vee \neg P(2,3,0)) \wedge \\
& (P(0,3,1) \vee P(1,3,1) \vee P(2,3,1)) \wedge (\neg P(0,3,1) \vee \neg P(1,3,1)) \wedge (\neg P(0,3,1) \vee \neg P(2,3,1)) \wedge (\neg P(1,3,1) \vee \neg P(2,3,1)) \wedge \\
& (P(0,3,2) \vee P(1,3,2) \vee P(2,3,2)) \wedge (\neg P(0,3,2) \vee \neg P(1,3,2)) \wedge (\neg P(0,3,2) \vee \neg P(2,3,2)) \wedge (\neg P(1,3,2) \vee \neg P(2,3,2)) \wedge \\
& (P(0,3,3) \vee P(1,3,3) \vee P(2,3,3)) \wedge (\neg P(0,3,3) \vee \neg P(1,3,3)) \wedge (\neg P(0,3,3) \vee \neg P(2,3,3)) \wedge (\neg P(1,3,3) \vee \neg P(2,3,3)) \wedge \\
& (P(0,3,4) \vee P(1,3,4) \vee P(2,3,4)) \wedge (\neg P(0,3,4) \vee \neg P(1,3,4)) \wedge (\neg P(0,3,4) \vee \neg P(2,3,4)) \wedge (\neg P(1,3,4) \vee \neg P(2,3,4)) \wedge \\
& (P(0,4,0) \vee P(1,4,0) \vee P(2,4,0)) \wedge (\neg P(0,4,0) \vee \neg P(1,4,0)) \wedge (\neg P(0,4,0) \vee \neg P(2,4,0)) \wedge (\neg P(1,4,0) \vee \neg P(2,4,0)) \wedge \\
& (P(0,4,1) \vee P(1,4,1) \vee P(2,4,1)) \wedge (\neg P(0,4,1) \vee \neg P(1,4,1)) \wedge (\neg P(0,4,1) \vee \neg P(2,4,1)) \wedge (\neg P(1,4,1) \vee \neg P(2,4,1)) \wedge \\
& (P(0,4,2) \vee P(1,4,2) \vee P(2,4,2)) \wedge (\neg P(0,4,2) \vee \neg P(1,4,2)) \wedge (\neg P(0,4,2) \vee \neg P(2,4,2)) \wedge (\neg P(1,4,2) \vee \neg P(2,4,2)) \wedge \\
& (P(0,4,3) \vee P(1,4,3) \vee P(2,4,3)) \wedge (\neg P(0,4,3) \vee \neg P(1,4,3)) \wedge (\neg P(0,4,3) \vee \neg P(2,4,3)) \wedge (\neg P(1,4,3) \vee \neg P(2,4,3)) \wedge \\
& (P(0,4,4) \vee P(1,4,4) \vee P(2,4,4)) \wedge (\neg P(0,4,4) \vee \neg P(1,4,4)) \wedge (\neg P(0,4,4) \vee \neg P(2,4,4)) \wedge (\neg P(1,4,4) \vee \neg P(2,4,4)) \wedge \\
& (Q(0,0) \vee Q(1,0) \vee Q(2,0) \vee Q(3,0)) \wedge \hspace{15em} // \text{group 2} \\
& (\neg Q(0,0) \vee \neg Q(1,0)) \wedge (\neg Q(0,0) \vee \neg Q(2,0)) \wedge (\neg Q(0,0) \vee \neg Q(3,0)) \wedge \\
& (\neg Q(1,0) \vee \neg Q(2,0)) \wedge (\neg Q(1,0) \vee \neg Q(3,0)) \wedge \\
& (\neg Q(2,0) \vee \neg Q(3,0)) \wedge \\
& (Q(0,1) \vee Q(1,1) \vee Q(2,1) \vee Q(3,1)) \wedge \\
& (\neg Q(0,1) \vee \neg Q(1,1)) \wedge (\neg Q(0,1) \vee \neg Q(2,1)) \wedge (\neg Q(0,1) \vee \neg Q(3,1)) \wedge \\
& (\neg Q(1,1) \vee \neg Q(2,1)) \wedge (\neg Q(1,1) \vee \neg Q(3,1)) \wedge \\
& (\neg Q(2,1) \vee \neg Q(3,1)) \wedge \\
& (Q(0,2) \vee Q(1,2) \vee Q(2,2) \vee Q(3,2)) \wedge \\
& (\neg Q(0,2) \vee \neg Q(1,2)) \wedge (\neg Q(0,2) \vee \neg Q(2,2)) \wedge (\neg Q(0,2) \vee \neg Q(3,2)) \wedge \\
& (\neg Q(1,2) \vee \neg Q(2,2)) \wedge (\neg Q(1,2) \vee \neg Q(3,2)) \wedge \\
& (\neg Q(2,2) \vee \neg Q(3,2)) \wedge \\
& (Q(0,3) \vee Q(1,3) \vee Q(2,3) \vee Q(3,3)) \wedge \\
& (\neg Q(0,3) \vee \neg Q(1,3)) \wedge (\neg Q(0,3) \vee \neg Q(2,3)) \wedge (\neg Q(0,3) \vee \neg Q(3,3)) \wedge \\
& (\neg Q(1,3) \vee \neg Q(2,3)) \wedge (\neg Q(1,3) \vee \neg Q(3,3)) \wedge \\
& (\neg Q(2,3) \vee \neg Q(3,3)) \wedge \\
& (Q(0,4) \vee Q(1,4) \vee Q(2,4) \vee Q(3,4)) \wedge \\
& (\neg Q(0,4) \vee \neg Q(1,4)) \wedge (\neg Q(0,4) \vee \neg Q(2,4)) \wedge (\neg Q(0,4) \vee \neg Q(3,4)) \wedge \\
& (\neg Q(1,4) \vee \neg Q(2,4)) \wedge (\neg Q(1,4) \vee \neg Q(3,4)) \wedge \\
& (\neg Q(2,4) \vee \neg Q(3,4)) \wedge \\
& (S(0,0) \vee S(1,0) \vee S(2,0) \vee S(3,0) \vee S(4,0)) \wedge \hspace{15em} // \text{group 3} \\
& (\neg S(0,0) \vee \neg S(1,0)) \wedge (\neg S(0,0) \vee \neg S(2,0)) \wedge (\neg S(0,0) \vee \neg S(3,0)) \wedge (\neg S(0,0) \vee \neg S(4,0)) \wedge \\
& (\neg S(1,0) \vee \neg S(2,0)) \wedge (\neg S(1,0) \vee \neg S(3,0)) \wedge (\neg S(1,0) \vee \neg S(4,0)) \wedge \\
& (\neg S(2,0) \vee \neg S(3,0)) \wedge (\neg S(2,0) \vee \neg S(4,0)) \wedge \\
& (\neg S(3,0) \vee \neg S(4,0)) \wedge \\
& (S(0,1) \vee S(1,1) \vee S(2,1) \vee S(3,1) \vee S(4,1)) \wedge \\
& (\neg S(0,1) \vee \neg S(1,1)) \wedge (\neg S(0,1) \vee \neg S(2,1)) \wedge (\neg S(0,1) \vee \neg S(3,1)) \wedge (\neg S(0,1) \vee \neg S(4,1)) \wedge \\
& (\neg S(1,1) \vee \neg S(2,1)) \wedge (\neg S(1,1) \vee \neg S(3,1)) \wedge (\neg S(1,1) \vee \neg S(4,1)) \wedge \\
& (\neg S(2,1) \vee \neg S(3,1)) \wedge (\neg S(2,1) \vee \neg S(4,1)) \wedge
\end{aligned}$$

$$\begin{aligned}
& (\neg S(3,1) \vee \neg S(4,1)) \wedge \\
& (S(0,2) \vee S(1,2) \vee S(2,2) \vee S(3,2) \vee S(4,2)) \wedge \\
& (\neg S(0,2) \vee \neg S(1,2)) \wedge (\neg S(0,2) \vee \neg S(2,2)) \wedge (\neg S(0,2) \vee \neg S(3,2)) \wedge (\neg S(0,2) \vee \neg S(4,2)) \wedge \\
& (\neg S(1,2) \vee \neg S(2,2)) \wedge (\neg S(1,2) \vee \neg S(3,2)) \wedge (\neg S(1,2) \vee \neg S(4,2)) \wedge \\
& (\neg S(2,2) \vee \neg S(3,2)) \wedge (\neg S(2,2) \vee \neg S(4,2)) \wedge \\
& (\neg S(3,2) \vee \neg S(4,2)) \wedge \\
& (S(0,3) \vee S(1,3) \vee S(2,3) \vee S(3,3) \vee S(4,3)) \wedge \\
& (\neg S(0,3) \vee \neg S(1,3)) \wedge (\neg S(0,3) \vee \neg S(2,3)) \wedge (\neg S(0,3) \vee \neg S(3,3)) \wedge (\neg S(0,3) \vee \neg S(4,3)) \wedge \\
& (\neg S(1,3) \vee \neg S(2,3)) \wedge (\neg S(1,3) \vee \neg S(3,3)) \wedge (\neg S(1,3) \vee \neg S(4,3)) \wedge \\
& (\neg S(2,3) \vee \neg S(3,3)) \wedge (\neg S(2,3) \vee \neg S(4,3)) \wedge \\
& (\neg S(3,3) \vee \neg S(4,3)) \wedge \\
& (S(0,4) \vee S(1,4) \vee S(2,4) \vee S(3,4) \vee S(4,4)) \wedge \\
& (\neg S(0,4) \vee \neg S(1,4)) \wedge (\neg S(0,4) \vee \neg S(2,4)) \wedge (\neg S(0,4) \vee \neg S(3,4)) \wedge (\neg S(0,4) \vee \neg S(4,4)) \wedge \\
& (\neg S(1,4) \vee \neg S(2,4)) \wedge (\neg S(1,4) \vee \neg S(3,4)) \wedge (\neg S(1,4) \vee \neg S(4,4)) \wedge \\
& (\neg S(2,4) \vee \neg S(3,4)) \wedge (\neg S(2,4) \vee \neg S(4,4)) \wedge \\
& (\neg S(3,4) \vee \neg S(4,4)) \wedge \\
& Q(0,0) \wedge S(0,0) \wedge P(0,0,0) \wedge P(1,1,0) \wedge P(0,2,0) \wedge P(\#,3,0) \wedge P(\#,4,0) \wedge \qquad // \text{group 4} \\
& (\neg P(0,0,0) \vee \neg Q(0,0) \vee \neg S(0,0) \vee Q(0,1)) \wedge (\neg P(0,0,1) \vee \neg Q(0,1) \vee \neg S(0,1) \vee Q(0,2)) \wedge \qquad // \text{group 5} \\
& (\neg P(0,0,2) \vee \neg Q(0,2) \vee \neg S(0,2) \vee Q(0,3)) \wedge (\neg P(0,0,3) \vee \neg Q(0,3) \vee \neg S(0,3) \vee Q(0,4)) \wedge \\
& (\neg P(1,0,0) \vee \neg Q(0,0) \vee \neg S(0,0) \vee Q(1,1)) \wedge (\neg P(1,0,1) \vee \neg Q(0,1) \vee \neg S(0,1) \vee Q(1,2)) \wedge \\
& (\neg P(1,0,2) \vee \neg Q(0,2) \vee \neg S(0,2) \vee Q(1,3)) \wedge (\neg P(1,0,3) \vee \neg Q(0,3) \vee \neg S(0,3) \vee Q(1,4)) \wedge \\
& // A blank # in cell 0 in state 0 causes M to halt to prevent it from sliding off the tape: \\
& (\neg P(\#,0,0) \vee \neg Q(0,0) \vee \neg S(0,0) \vee Q(3,1)) \wedge (\neg P(\#,0,1) \vee \neg Q(0,1) \vee \neg S(0,1) \vee Q(3,2)) \wedge \\
& (\neg P(\#,0,2) \vee \neg Q(0,2) \vee \neg S(0,2) \vee Q(3,3)) \wedge (\neg P(\#,0,3) \vee \neg Q(0,3) \vee \neg S(0,3) \vee Q(3,4)) \wedge \\
& (\neg P(0,1,0) \vee \neg Q(0,0) \vee \neg S(1,0) \vee Q(0,1)) \wedge (\neg P(0,1,1) \vee \neg Q(0,1) \vee \neg S(1,1) \vee Q(0,2)) \wedge \\
& (\neg P(0,1,2) \vee \neg Q(0,2) \vee \neg S(1,2) \vee Q(0,3)) \wedge (\neg P(0,1,3) \vee \neg Q(0,3) \vee \neg S(1,3) \vee Q(0,4)) \wedge \\
& (\neg P(1,1,0) \vee \neg Q(0,0) \vee \neg S(1,0) \vee Q(1,1)) \wedge (\neg P(1,1,1) \vee \neg Q(0,1) \vee \neg S(1,1) \vee Q(1,2)) \wedge \\
& (\neg P(1,1,2) \vee \neg Q(0,2) \vee \neg S(1,2) \vee Q(1,3)) \wedge (\neg P(1,1,3) \vee \neg Q(0,3) \vee \neg S(1,3) \vee Q(1,4)) \wedge \\
& (\neg P(\#,1,0) \vee \neg Q(0,0) \vee \neg S(1,0) \vee Q(2,1)) \wedge (\neg P(\#,1,1) \vee \neg Q(0,1) \vee \neg S(1,1) \vee Q(2,2)) \wedge \\
& (\neg P(\#,1,2) \vee \neg Q(0,2) \vee \neg S(1,2) \vee Q(2,3)) \wedge (\neg P(\#,1,3) \vee \neg Q(0,3) \vee \neg S(1,3) \vee Q(2,4)) \wedge \\
& (\neg P(0,2,0) \vee \neg Q(0,0) \vee \neg S(2,0) \vee Q(0,1)) \wedge (\neg P(0,2,1) \vee \neg Q(0,1) \vee \neg S(2,1) \vee Q(0,2)) \wedge \\
& (\neg P(0,2,2) \vee \neg Q(0,2) \vee \neg S(2,2) \vee Q(0,3)) \wedge (\neg P(0,2,3) \vee \neg Q(0,3) \vee \neg S(2,3) \vee Q(0,4)) \wedge \\
& (\neg P(1,2,0) \vee \neg Q(0,0) \vee \neg S(2,0) \vee Q(1,1)) \wedge (\neg P(1,2,1) \vee \neg Q(0,1) \vee \neg S(2,1) \vee Q(1,2)) \wedge \\
& (\neg P(1,2,2) \vee \neg Q(0,2) \vee \neg S(2,2) \vee Q(1,3)) \wedge (\neg P(1,2,3) \vee \neg Q(0,3) \vee \neg S(2,3) \vee Q(1,4)) \wedge \\
& (\neg P(\#,2,0) \vee \neg Q(0,0) \vee \neg S(2,0) \vee Q(2,1)) \wedge (\neg P(\#,2,1) \vee \neg Q(0,1) \vee \neg S(2,1) \vee Q(2,2)) \wedge \\
& (\neg P(\#,2,2) \vee \neg Q(0,2) \vee \neg S(2,2) \vee Q(2,3)) \wedge (\neg P(\#,2,3) \vee \neg Q(0,3) \vee \neg S(2,3) \vee Q(2,4)) \wedge \\
& (\neg P(0,3,0) \vee \neg Q(0,0) \vee \neg S(3,0) \vee Q(0,1)) \wedge (\neg P(0,3,1) \vee \neg Q(0,1) \vee \neg S(3,1) \vee Q(0,2)) \wedge \\
& (\neg P(0,3,2) \vee \neg Q(0,2) \vee \neg S(3,2) \vee Q(0,3)) \wedge (\neg P(0,3,3) \vee \neg Q(0,3) \vee \neg S(3,3) \vee Q(0,4)) \wedge \\
& (\neg P(1,3,0) \vee \neg Q(0,0) \vee \neg S(3,0) \vee Q(1,1)) \wedge (\neg P(1,3,1) \vee \neg Q(0,1) \vee \neg S(3,1) \vee Q(1,2)) \wedge \\
& (\neg P(1,3,2) \vee \neg Q(0,2) \vee \neg S(3,2) \vee Q(1,3)) \wedge (\neg P(1,3,3) \vee \neg Q(0,3) \vee \neg S(3,3) \vee Q(1,4)) \wedge \\
& (\neg P(\#,3,0) \vee \neg Q(0,0) \vee \neg S(3,0) \vee Q(2,1)) \wedge (\neg P(\#,3,1) \vee \neg Q(0,1) \vee \neg S(3,1) \vee Q(2,2)) \wedge \\
& (\neg P(\#,3,2) \vee \neg Q(0,2) \vee \neg S(3,2) \vee Q(2,3)) \wedge (\neg P(\#,3,3) \vee \neg Q(0,3) \vee \neg S(3,3) \vee Q(2,4)) \wedge \\
& (\neg P(0,4,0) \vee \neg Q(0,0) \vee \neg S(4,0) \vee Q(0,1)) \wedge (\neg P(0,4,1) \vee \neg Q(0,1) \vee \neg S(4,1) \vee Q(0,2)) \wedge \\
& (\neg P(0,4,2) \vee \neg Q(0,2) \vee \neg S(4,2) \vee Q(0,3)) \wedge (\neg P(0,4,3) \vee \neg Q(0,3) \vee \neg S(4,3) \vee Q(0,4)) \wedge \\
& (\neg P(1,4,0) \vee \neg Q(0,0) \vee \neg S(4,0) \vee Q(1,1)) \wedge (\neg P(1,4,1) \vee \neg Q(0,1) \vee \neg S(4,1) \vee Q(1,2)) \wedge \\
& (\neg P(1,4,2) \vee \neg Q(0,2) \vee \neg S(4,2) \vee Q(1,3)) \wedge (\neg P(1,4,3) \vee \neg Q(0,3) \vee \neg S(4,3) \vee Q(1,4)) \wedge \\
& (\neg P(\#,4,0) \vee \neg Q(0,0) \vee \neg S(4,0) \vee Q(2,1)) \wedge (\neg P(\#,4,1) \vee \neg Q(0,1) \vee \neg S(4,1) \vee Q(2,2)) \wedge
\end{aligned}$$









$$\begin{aligned}
& (\neg P(1,3,0) \vee \neg Q(3,0) \vee \neg S(3,0) \vee P(1,3,1)) \wedge (\neg P(1,3,1) \vee \neg Q(3,1) \vee \neg S(3,1) \vee P(1,3,2)) \wedge \\
& (\neg P(1,3,2) \vee \neg Q(3,2) \vee \neg S(3,2) \vee P(1,3,3)) \wedge (\neg P(1,3,3) \vee \neg Q(3,3) \vee \neg S(3,3) \vee P(1,3,4)) \wedge \\
& (\neg P(\#,3,0) \vee \neg Q(3,0) \vee \neg S(3,0) \vee P(\#,3,1)) \wedge (\neg P(\#,3,1) \vee \neg Q(3,1) \vee \neg S(3,1) \vee P(\#,3,2)) \wedge \\
& (\neg P(\#,3,2) \vee \neg Q(3,2) \vee \neg S(3,2) \vee P(\#,3,3)) \wedge (\neg P(\#,3,3) \vee \neg Q(3,3) \vee \neg S(3,3) \vee P(\#,3,4)) \wedge \\
& (\neg P(0,4,0) \vee \neg Q(3,0) \vee \neg S(4,0) \vee P(0,4,1)) \wedge (\neg P(0,4,1) \vee \neg Q(3,1) \vee \neg S(4,1) \vee P(0,4,2)) \wedge \\
& (\neg P(0,4,2) \vee \neg Q(3,2) \vee \neg S(4,2) \vee P(0,4,3)) \wedge (\neg P(0,4,3) \vee \neg Q(3,3) \vee \neg S(4,3) \vee P(0,4,4)) \wedge \\
& (\neg P(1,4,0) \vee \neg Q(3,0) \vee \neg S(4,0) \vee P(1,4,1)) \wedge (\neg P(1,4,1) \vee \neg Q(3,1) \vee \neg S(4,1) \vee P(1,4,2)) \wedge \\
& (\neg P(1,4,2) \vee \neg Q(3,2) \vee \neg S(4,2) \vee P(1,4,3)) \wedge (\neg P(1,4,3) \vee \neg Q(3,3) \vee \neg S(4,3) \vee P(1,4,4)) \wedge \\
& (\neg P(\#,4,0) \vee \neg Q(3,0) \vee \neg S(4,0) \vee P(\#,4,1)) \wedge (\neg P(\#,4,1) \vee \neg Q(3,1) \vee \neg S(4,1) \vee P(\#,4,2)) \wedge \\
& (\neg P(\#,4,2) \vee \neg Q(3,2) \vee \neg S(4,2) \vee P(\#,4,3)) \wedge (\neg P(\#,4,3) \vee \neg Q(3,3) \vee \neg S(4,3) \vee P(\#,4,4)) \wedge \\
& (\neg P(0,0,0) \vee \neg Q(0,0) \vee \neg S(0,0) \vee S(1,1)) \wedge (\neg P(0,0,1) \vee \neg Q(0,1) \vee \neg S(0,1) \vee S(1,2)) \wedge \\
& (\neg P(0,0,2) \vee \neg Q(0,2) \vee \neg S(0,2) \vee S(1,3)) \wedge (\neg P(0,0,3) \vee \neg Q(0,3) \vee \neg S(0,3) \vee S(1,4)) \wedge \\
& (\neg P(1,0,0) \vee \neg Q(0,0) \vee \neg S(0,0) \vee S(1,1)) \wedge (\neg P(1,0,1) \vee \neg Q(0,1) \vee \neg S(0,1) \vee S(1,2)) \wedge \\
& (\neg P(1,0,2) \vee \neg Q(0,2) \vee \neg S(0,2) \vee S(1,3)) \wedge (\neg P(1,0,3) \vee \neg Q(0,3) \vee \neg S(0,3) \vee S(1,4)) \wedge \\
& // passing from  $S(0,0)$  to  $S(-1,1)$  means sliding off the tape, that is, halting execution;  $M$  remains in cell 0: \\
& (\neg P(\#,0,0) \vee \neg Q(0,0) \vee \neg S(0,0) \vee S(0,1)) \wedge (\neg P(\#,0,1) \vee \neg Q(0,1) \vee \neg S(0,1) \vee S(0,2)) \wedge \\
& (\neg P(\#,0,2) \vee \neg Q(0,2) \vee \neg S(0,2) \vee S(0,3)) \wedge (\neg P(\#,0,3) \vee \neg Q(0,3) \vee \neg S(0,3) \vee S(0,4)) \wedge \\
& (\neg P(0,1,0) \vee \neg Q(0,0) \vee \neg S(1,0) \vee S(2,1)) \wedge (\neg P(0,1,1) \vee \neg Q(0,1) \vee \neg S(1,1) \vee S(2,2)) \wedge \\
& (\neg P(0,1,2) \vee \neg Q(0,2) \vee \neg S(1,2) \vee S(2,3)) \wedge (\neg P(0,1,3) \vee \neg Q(0,3) \vee \neg S(1,3) \vee S(2,4)) \wedge \\
& (\neg P(1,1,0) \vee \neg Q(0,0) \vee \neg S(1,0) \vee S(2,1)) \wedge (\neg P(1,1,1) \vee \neg Q(0,1) \vee \neg S(1,1) \vee S(2,2)) \wedge \\
& (\neg P(1,1,2) \vee \neg Q(0,2) \vee \neg S(1,2) \vee S(2,3)) \wedge (\neg P(1,1,3) \vee \neg Q(0,3) \vee \neg S(1,3) \vee S(2,4)) \wedge \\
& (\neg P(\#,1,0) \vee \neg Q(0,0) \vee \neg S(1,0) \vee S(0,1)) \wedge (\neg P(\#,1,1) \vee \neg Q(0,1) \vee \neg S(1,1) \vee S(0,2)) \wedge \\
& (\neg P(\#,1,2) \vee \neg Q(0,2) \vee \neg S(1,2) \vee S(0,3)) \wedge (\neg P(\#,1,3) \vee \neg Q(0,3) \vee \neg S(1,3) \vee S(0,4)) \wedge \\
& (\neg P(0,2,0) \vee \neg Q(0,0) \vee \neg S(2,0) \vee S(3,1)) \wedge (\neg P(0,2,1) \vee \neg Q(0,1) \vee \neg S(2,1) \vee S(3,2)) \wedge \\
& (\neg P(0,2,2) \vee \neg Q(0,2) \vee \neg S(2,2) \vee S(3,3)) \wedge (\neg P(0,2,3) \vee \neg Q(0,3) \vee \neg S(2,3) \vee S(3,4)) \wedge \\
& (\neg P(1,2,0) \vee \neg Q(0,0) \vee \neg S(2,0) \vee S(3,1)) \wedge (\neg P(1,2,1) \vee \neg Q(0,1) \vee \neg S(2,1) \vee S(3,2)) \wedge \\
& (\neg P(1,2,2) \vee \neg Q(0,2) \vee \neg S(2,2) \vee S(3,3)) \wedge (\neg P(1,2,3) \vee \neg Q(0,3) \vee \neg S(2,3) \vee S(3,4)) \wedge \\
& (\neg P(\#,2,0) \vee \neg Q(0,0) \vee \neg S(2,0) \vee S(1,1)) \wedge (\neg P(\#,2,1) \vee \neg Q(0,1) \vee \neg S(2,1) \vee S(1,2)) \wedge \\
& (\neg P(\#,2,2) \vee \neg Q(0,2) \vee \neg S(2,2) \vee S(1,3)) \wedge (\neg P(\#,2,3) \vee \neg Q(0,3) \vee \neg S(2,3) \vee S(1,4)) \wedge \\
& (\neg P(0,3,0) \vee \neg Q(0,0) \vee \neg S(3,0) \vee S(4,1)) \wedge (\neg P(0,3,1) \vee \neg Q(0,1) \vee \neg S(3,1) \vee S(4,2)) \wedge \\
& (\neg P(0,3,2) \vee \neg Q(0,2) \vee \neg S(3,2) \vee S(4,3)) \wedge (\neg P(0,3,3) \vee \neg Q(0,3) \vee \neg S(3,3) \vee S(4,4)) \wedge \\
& (\neg P(1,3,0) \vee \neg Q(0,0) \vee \neg S(3,0) \vee S(4,1)) \wedge (\neg P(1,3,1) \vee \neg Q(0,1) \vee \neg S(3,1) \vee S(4,2)) \wedge \\
& (\neg P(1,3,2) \vee \neg Q(0,2) \vee \neg S(3,2) \vee S(4,3)) \wedge (\neg P(1,3,3) \vee \neg Q(0,3) \vee \neg S(3,3) \vee S(4,4)) \wedge \\
& (\neg P(\#,3,0) \vee \neg Q(0,0) \vee \neg S(3,0) \vee S(2,1)) \wedge (\neg P(\#,3,1) \vee \neg Q(0,1) \vee \neg S(3,1) \vee S(2,2)) \wedge \\
& (\neg P(\#,3,2) \vee \neg Q(0,2) \vee \neg S(3,2) \vee S(2,3)) \wedge (\neg P(\#,3,3) \vee \neg Q(0,3) \vee \neg S(3,3) \vee S(2,4)) \wedge \\
& (\neg P(0,4,0) \vee \neg Q(0,0) \vee \neg S(4,0) \vee S(5,1)) \wedge (\neg P(0,4,1) \vee \neg Q(0,1) \vee \neg S(4,1) \vee S(5,2)) \wedge \\
& (\neg P(0,4,2) \vee \neg Q(0,2) \vee \neg S(4,2) \vee S(5,3)) \wedge (\neg P(0,4,3) \vee \neg Q(0,3) \vee \neg S(4,3) \vee S(5,4)) \wedge \\
& (\neg P(1,4,0) \vee \neg Q(0,0) \vee \neg S(4,0) \vee S(5,1)) \wedge (\neg P(1,4,1) \vee \neg Q(0,1) \vee \neg S(4,1) \vee S(5,2)) \wedge \\
& (\neg P(1,4,2) \vee \neg Q(0,2) \vee \neg S(4,2) \vee S(5,3)) \wedge (\neg P(1,4,3) \vee \neg Q(0,3) \vee \neg S(4,3) \vee S(5,4)) \wedge \\
& (\neg P(\#,4,0) \vee \neg Q(0,0) \vee \neg S(4,0) \vee S(3,1)) \wedge (\neg P(\#,4,1) \vee \neg Q(0,1) \vee \neg S(4,1) \vee S(3,2)) \wedge \\
& (\neg P(\#,4,2) \vee \neg Q(0,2) \vee \neg S(4,2) \vee S(3,3)) \wedge (\neg P(\#,4,3) \vee \neg Q(0,3) \vee \neg S(4,3) \vee S(3,4)) \wedge \\
& (\neg P(0,0,0) \vee \neg Q(1,0) \vee \neg S(0,0) \vee S(1,1)) \wedge (\neg P(0,0,1) \vee \neg Q(1,1) \vee \neg S(0,1) \vee S(1,2)) \wedge \\
& (\neg P(0,0,2) \vee \neg Q(1,2) \vee \neg S(0,2) \vee S(1,3)) \wedge (\neg P(0,0,3) \vee \neg Q(1,3) \vee \neg S(0,3) \vee S(1,4)) \wedge \\
& (\neg P(1,0,0) \vee \neg Q(1,0) \vee \neg S(0,0) \vee S(1,1)) \wedge (\neg P(1,0,1) \vee \neg Q(1,1) \vee \neg S(0,1) \vee S(1,2)) \wedge \\
& (\neg P(1,0,2) \vee \neg Q(1,2) \vee \neg S(0,2) \vee S(1,3)) \wedge (\neg P(1,0,3) \vee \neg Q(1,3) \vee \neg S(0,3) \vee S(1,4)) \wedge \\
& // an attempt to slide off the tape;  $M$  halts and remains in cell 0:
\end{aligned}$$







---

# Name Index

---

- Ackermann, Wilhelm, 187  
Adel'son-Vel'skii, G. M., 297  
Aho, Alfred V., 676, 716  
Ahuja, Ravindra K., 466  
Allan, Stephen J., 606, 647  
Allen, Brian, 261, 297  
Appel, Andrew W., 624, 627, 644,  
647, 648  
Auslander, M. A., 213
- Bachmann, Paul, 57  
Baer, J. L., 297  
Baeza-Yates, Ricardo, 672, 703,  
714, 716  
Baker, Henry G., 625, 634, 645,  
648  
Barber, Angus, 517  
Barron, David W., 212  
Barth, Gerhard, 650, 716  
Bayer, Rudolf, 301, 316, 317, 323,  
374  
Bell, James R., 267, 297, 566, 568,  
602  
Bell, Timothy C., 603  
Bentley, Jon L., 139, 375  
Berge, Claude, 423, 466  
Berlioux, Pierre, 212  
Bertsekas, Dimitri, 389, 466  
Berztiss, Alfs, 296  
Bird, Richard S., 212, 213  
Bitner, James R., 261, 297  
Blackstone, John H., 157, 168  
Bollobés, B., 297  
Bondy, John A., 428, 436, 466  
Boruvka, Otakar, 461  
Bourne, Charles P., 353, 375  
Boyer, Robert S., 716  
Bracha, Silad, 55  
Brassard, G., 79  
Brélaz, Daniel, 444, 466  
Bretholz, E., 135, 139  
Briandais, Rene de la, 352, 375  
Bromley, Allan G., 615, 647
- Brooks, Rodney A., 627, 648  
Burge, William H., 212  
Burkhard, W. A., 296  
Busacker, R. G., 418
- Campbell, J. A., 643, 647  
Cardelli, Luca, 55  
Carlsson, Svente, 518  
Carroll, Lewis, 150  
Celis, P., 567, 568  
Chang, Hsi, 297  
Chen, Qi F., 568  
Chen, Wen C., 569  
Cheney, C. J., 623, 634, 648  
Chvátal, V., 436, 466  
Cichelli, Richard J., 533, 568  
Cleary, J. G., 602, 603  
Cohen, Jacques, 648  
Cole, Richard, 668, 716  
Comer, Douglas, 312, 353, 374,  
375  
Cook, Curtis R., 494, 518, 535, 568  
Cook, Stephen A., 75, 79, 494  
Copes, Wayne, 168  
Corasick, Margaret J., 676, 716  
Cormack, Gordon V., 585, 603  
Cranston, Ben, 613, 647  
Culberson, Joseph, 248, 296  
Czech, Zbigniew, J., 568
- Daoud, Amjad M., 568  
Day, A. Colin, 252, 297  
deMaine, P. A. D., 353, 375  
Deo, Narsingh, 388, 466  
D'Esopo, D., 388  
Dijkstra, Edsger W., 172, 213, 384,  
419, 466  
Ding, Yuzheng, 488, 518  
Dinic, Efim A., 414, 466  
Doberkat, E. E., 275, 297  
Dobosiewicz, W., 483, 517  
Dood, M., 568  
Downing, Troy, 168
- Dromey, R. G., 518  
Drozdek, Adam, 603, 698, 716  
Dunn, Douglas, 55  
Durian, B., 518  
Dvorak, S., 518  
Dy, H. C., 568  
Dymes, Ruth, 150  
Edmonds, Jack, 392, 412, 431, 434,  
466  
Ege, Raimund K., 55  
Ellis, John R., 627, 644, 648  
Enbody, R. J., 568  
Eppinger, Jeffrey L., 248, 296  
Euler, Leonhard, 432
- Fagin, Ronald, 538, 568  
Faller, Newton, 582, 603  
Faloutsos, Christos, 321, 374  
Fenichel, Robert R., 623, 648  
Ferguson, David E., 319, 374  
Finkel, R. A., 375  
Fischer, M. J., 696, 717  
Fleury, 433, 466  
Flores, Ivan, 517  
Floyd, Robert W., 272, 275, 292,  
298, 390, 461, 467, 485  
Folk, Michael J., 374  
Ford, Donald F., 353, 375  
Ford, Lester R., 386, 407, 408, 418,  
467  
Foster, Caxton C., 297  
Foster, John M., 139, 260  
Fox, Edward A., 536, 568  
Frazer, William D., 518  
Fredkin, Edward, 349, 375  
Frieze, A., 298  
Fulkerson, D. R., 407, 408, 418,  
467  
Fuller, S. H., 297
- Gale, David, 427, 467, 517  
Galil, Zvi, 671, 716  
Gallager, Robert G., 582, 603

- Gallo, Giorgio, 383, 386, 389, 467  
 Garey, Michael R., 79  
 Gibbons, Alan, 434, 467  
 Gittleman, Art, 55  
 Glover, Fred, 389, 467  
 Glover, Randy, 389, 467  
 Gonnett, Gaston H., 298, 672, 714, 716  
 Gosling, James, 55  
 Gould, Ronald, 467  
 Gowen, P. J., 418  
 Graham, R. L., 396, 467  
 Guibas, Leo J., 324, 374, 668, 716  
 Gupta, Gopal, 267, 297  
 Guttman, Antonin, 320, 374  
 Haggard, G., 535, 568  
 Hagins, Jeff, 615, 644, 647  
 Hall, Philip, 451, 467  
 Hamilton, William, 53  
 Hancart, Christophe, 651, 652, 716  
 Hankamer, M., 601, 603  
 Hansen, Wilfred J., 139  
 Hanson, E., 321, 375  
 Hartmanis, Juris, 56, 79  
 Hayward, Ryan, 275, 298  
 Heaps, H. S., 602, 603  
 Heath, Lenwood S., 568  
 Heileman, Gregory, 79  
 Hell, Pavol, 396, 467  
 Hendriksen, James O., 158, 168  
 Hester, James H., 139  
 Hewitt, Carl, 627, 633, 648  
 Hibbard, Thomas N., 246, 291, 296, 516  
 Hinds, James A., 613, 647  
 Hirschberg, Daniel S., 139, 603, 613, 647  
 Hoare, Charles A. R., 488, 518  
 Hogg, Gary L., 168  
 Hopcroft, John E., 79, 379  
 Horowitz, E., 355, 375  
 Horspool, R. Nigel, 585, 603, 713, 716  
 Huang, B. C., 518  
 Huffman, David A., 572, 603  
 Hunt, James W., 698, 716  
 Incerpi, Janet, 483, 517  
 Ingerman, P. Z., 390, 467  
 Iri, M., 418  
 Isaacson, Joel D., 467  
 Iyengar, S. Sitharama, 297  
 Jarnik, Vojtech, 462  
 Jewell, W. S., 418  
 Johnson, David S., 73, 79, 372, 463, 467  
 Johnson, Donald B., 385, 467  
 Johnson, Elias L., 434, 466  
 Johnson, Theodore, 374  
 Johnsson, C. B., 644  
 Jonassen, Arne T., 248, 296  
 Jones, Douglas W., 158, 168  
 Jones, Richard, 648  
 Joshi, Daniel i., 168  
 Joy, Bill, 55  
 Julstrom A., 516, 518  
 Kaehler, E. B., 297  
 Kalaba, Robert, 399, 467  
 Kaman, Charles H., 566, 568  
 Karlton, P. L., 260, 297  
 Karp, Richard M., 79, 392, 412, 466, 517  
 Karplus, K., 535, 568  
 Kershenbaum, Aaron, 460, 467  
 Khoshafian, Setrag, 55  
 Kim, Do Jin, 494, 518  
 Klingman, Darwin, 389, 467  
 Knott, G. D., 538, 568  
 Knowlton, Kenneth C., 608, 647  
 Knuth, Donald E., 79, 246, 248, 256, 275, 291, 296, 297, 312, 483, 515, 516, 517, 518, 526, 527, 568, 582, 603, 668, 704, 716  
 Koch, Helge von, 181  
 Kruskal, Joseph B., 396, 467  
 Kuhn, Harold W., 428, 467  
 Kurokawa, Toshiaki, 620, 621, 648  
 Kwan, Mei-ko, 467  
 Landis, E. M., 255, 297  
 Langston, M. A., 518  
 Larson, Per A., 538, 568  
 Layer, D. Kevin, 648  
 Lelever, Debra A., 603  
 Lemay, Laura, 168  
 Lempel, Abraham, 603  
 Leung, Clement H. C., 312, 374  
 Levenshtein, V. I., 695, 716  
 Lewis, Philip M., 468  
 Lewis, Ted G., 535, 568  
 Li, Kai, 627, 644, 648  
 Lieberman, Henry, 627, 633, 648  
 Lindholm, Tim, 168  
 Lins, Rafael, 648  
 Litwin, Witold, 538, 541, 568  
 Lomet, David B., 541, 568  
 Lorentz, Richard, 212  
 Lorin, Harold, 517  
 Lukasiewicz, Jan, 275, 291  
 Lum, V. Y., 520, 568  
 Magnanti, Thomas L., 466  
 Majewski, Bohdan S., 568  
 Maly, Kurt, 356, 375  
 Manber, Udi, 62, 79, 672, 693, 701, 703, 716, 717  
 Marble, George, 467  
 Martin, W. A., 297  
 Matthews, D., 135, 139  
 Matula, David W., 467  
 McCreight, Edward M., 301, 313, 374  
 McDiarmid, Colin, 275, 292, 298  
 McDonald, M. A., 291, 297  
 McGeoch, Catherine C., 139  
 McKellar, Archie C., 518  
 McLuckie, Keith, 517  
 Meertens, L., 79  
 Mehlhorn, Kurt, 517  
 Meyer, Bertrand, 55  
 Meyer, Jon, 168  
 Miller, Victor S., 588, 603  
 Moivre, A. de, 190  
 Moore, J. Strother, 716  
 Moret, B. M. E., 518  
 Morris, James H., 668, 704, 716  
 Morris, Joseph M., 236-239, 296  
 Morris, Robert, 525, 568  
 Morrison, Donald R., 374, 375  
 Motzkin, Dalia, 518  
 Mullin, James K., 544, 568  
 Munkres, James, 428, 468  
 Munro, J. Ian, 261, 297, 298, 567, 568, 569  
 Murty, U. S. R., 428, 466  
 Myers, Gene, 693, 716

- Napier, John, 208  
 Naughton, Patrick, 55  
 Ness, D. N., 297  
 Neumann, John von, 494  
 Ng, D. T. H., 135, 139  
 Nievergelt, Jurg, 568
- Odlyzko, Andrew M., 668, 716  
 Oldehoeft, Rodney R., 606, 647  
 Oommen, B. J., 139  
 Ore, Oystein, 436, 468  
 Orlin, James B., 466
- Page, Ivor P., 615, 644, 647  
 Pagli, L., 529, 568  
 Pallottino, Stefano, 383, 386, 389, 467  
 Pang, Chi-yin, 388, 466  
 Papadimitriou, Christos H., 74, 79, 463, 467, 468  
 Pape, U., 388, 389, 468  
 Papernov, A. A., 517  
 Perkins, Charles L., 168  
 Perleberg, Chris H., 703, 716  
 Peter, Rozsa, 187  
 Peterson, James L., 614, 647  
 Phillips, Don T., 168  
 Pippenger, Nicholas, 568  
 Pirklbauer, Klaus, 670, 716  
 Poblete, Patricio V., 567, 569  
 Pollack, Maurice, 388, 468  
 Poonen, Bjorn, 517  
 Pountain, Dick, 603  
 Powell, M. B., 443, 468  
 Pratt, Vaughan R., 517, 668, 704, 716  
 Preparata, Franco P., 79  
 Prim, Robert C., 462, 468  
 Pugh, William, 101, 139
- Radke, Charles E., 524, 569  
 Ramakrishna, M. V., 567  
 Razmik, Abnous, 55  
 Reed, B. A., 275, 292, 298  
 Reynolds, Carl W., 517  
 Riccardi, Greg, 374  
 Rich, R., 517  
 Richardson, Chris, 648  
 Rivest, Ronald, 139  
 Roberts, Eric, 212
- Rohl, Jeffrey S., 212  
 Rosenberg, Arnold L., 369, 374  
 Rosenkrantz, Daniel J., 463, 468  
 Ross, Douglas T., 606, 647  
 Rotem, D., 135, 139  
 Rotwitt, T., 353, 375  
 Roussopoulos, Nick, 321, 374  
 Rubin, Frank, 581, 603
- Sacco, William, 168  
 Sager, Thomas J., 536, 569  
 Salomon, David, 603  
 Samet, Hanan, 370, 375  
 Schildt, Herbert, 55  
 Schorr, H., 617-621, 648  
 Schuegraf, E. J., 602, 603  
 Schwab, B., 297  
 Scroggs, R. E., 297  
 Sebesta, Robert W., 535, 569  
 Sedgewick, Robert, 324, 374, 483, 517, 518  
 Sellers, Peter H., 715, 716  
 Sellis, Timos, 321, 374, 375  
 Sethi, Ravi, 353, 375  
 Shannon, Claude E., 571  
 Shapley, L. S., 427, 467  
 Shasha, Dennis, 372, 374  
 Shell, Donald L., 481, 517  
 Shen, Kenneth K., 614, 647  
 Simon, I., 297  
 Sleator, Daniel D., 139, 262, 265, 297  
 Sloyer, Clifford, 168  
 Smith, Harry F., 647  
 Smith, P. D., 670, 717  
 Snyder, Lawrence, 369, 374  
 Standish, Thomas A., 526, 644, 647  
 Starck, Robert, 168  
 Stasevich, G. V., 517  
 Stearns, Richard E., 56, 79, 468  
 Steiglitz, Kenneth, 468  
 Stonebraker, M., 321, 375  
 Stout, Quentin F., 252, 297  
 Strong, H. Raymond, 213, 568  
 Sunday, Daniel M., 668, 717  
 Al-Suwaiyel, M., 355, 375  
 Swamy, M. N. S., 428, 468  
 Szymanski, Thomas G., 698, 716
- Tarjan, Robert E., 79, 139, 262, 265, 297, 379, 403, 468
- Taylor, Mark A., 535, 569  
 Tharp, Alan L., 569  
 Thomas, Rick, 613, 647  
 Thompson, Ken, 683, 717  
 Thulasiraman, K., 428, 468
- Ukkonen, Esko, 689, 717  
 Unterauer, Karl, 316, 317, 374
- Vitanyi, P. M. B., 79  
 Vitter, Jeffrey S., 569
- Wadler, Philip L., 625, 648  
 Wagner, Richard A., 696, 717  
 Waite, W. M., 617-621, 648  
 Warren, Bette L., 252, 297  
 Warshall, Stephen, 390, 468  
 Weber, Joe, 55  
 Wedekind, H., 313, 375  
 Wegbreit, Ben, 620, 648  
 Wegener, Ingo, 518  
 Wegman, Mark N., 588, 603  
 Wegner, Peter, 55  
 Weinstock, C. B., 644  
 Weiss, Mark A., 55, 298, 488, 517, 518  
 Welch, Terry A., 588, 603  
 Welsh, D. J. A., 443, 468  
 Wiebenson, Walter, 388, 468  
 Wilkes, Maurice V., 139  
 Williams, J. W. J., 272, 275, 292, 298, 484, 518  
 Wilson, Paul R., 633, 648  
 Wirth, Niklaus, 213  
 Witten, Ian H., 602, 603  
 Witzgall, C., 388  
 Wood, Derick, 689, 717  
 Wu, Sun, 672, 701, 703, 717  
 Wulf, W. A., 644
- Yao, Andrew Chi-Chih, 311, 375  
 Yellin, Frank, 168  
 Yochelson, Jerome C., 623, 648  
 Yuasa, Taiichi, 630, 648  
 Yuen, P. S. T., 568
- Ziv, Jacob, 603  
 Zoellick, Bill, 374  
 Zorn, Benjamin, 633, 648  
 Zweben, S. H., 291, 297

---

# Subject Index

---

\*page numbers in *italic* represent diagrams/figures/pseudocode.

- abstract classes, 17
- abstract data types, 16–17, 140
- access time, 300–301
- Ackermann function, 187
- acrostics, 150
- activation record, 173
- active point, 690
- adaptive exact-fit method, 606–607
- adaptive Huffman coding, 581–586
- Ada, speed of, 56
- adding polynomials: case study, 507–514
  - implementation of program, 509–514
- adjacency list, 377
- adjacency matrix, 378
- adjacent vertices, 377
- admissible trees. *See* AVL trees
- Aho-Corasick algorithm, 676–678, 703
- algorithms, 405
  - acrostic, 150
  - adding large numbers (pseudocode), 144
  - Aho-Corasick algorithm, 676–678, 703
  - backtracking (psuedocode), 192
  - Baker’s algorithm, 625–627
  - binary search, 65
  - Boruvka’s algorithm, 462
  - Boyer-Moore algorithm, 660–668, 671
  - Boyer-Moore-Galil algorithm, 671
  - Cichelli’s algorithm, 533–536
  - classes of, 63
  - classified by time or space complexities, 62, 63, 64
  - comparison of run times for different sorting, 506
  - constant, 62, 63
  - cubic, 63, 64, 393
  - for deleting by copying, implementation of, 247
  - for deleting by merging, implementation of, 244–245
  - delimiter matching, 141–142, 142
  - depth-first search, 379–382
  - for dequeuing, 270
  - D’Esopo-Pape algorithm, 460
  - deterministic, 73–74
  - Dijkstra’s algorithm, 384–386
  - DSW, 252–255
  - efficient, 74
  - efficient sorting, 481–501
  - elementary sorting, 470–477
  - for enqueueing, 269
  - estimating efficiency of, with big-O notation, 59–61
  - evaluating efficiency of, 56–57
  - exponential, 63
  - FHCD algorithm, 536–538
  - flagFlipping, 328, 330–331
  - Fleury’s algorithm, 433
  - Ford’s algorithm, 386–388
  - Hancart’s algorithm, 651–652
  - Huffman algorithm, 572–573
  - Hunt-Szymanski algorithm, 699–701
  - implementation of insertion, 240
  - inefficient, 64
  - for inserting keys in B-trees, 306
  - to insert node into threaded tree, implementation of, 241
  - Jarnik-Prim algorithm, 462, 464
  - Kershenbaum’s algorithm, 460
  - Knuth-Morris-Pratt algorithm, 652–659, 679–680
  - Kruskal’s algorithm, 396–399
  - Kuhn-Munkres algorithm, 428–429
  - linear, 63
  - logarithmic, 63
  - Morris, 236–239, 237, 240
  - with nested loops, 65
  - nondeterministic, 73–74
  - $O(n \lg n)$ , 63
  - polynomial-time, 74
  - quadratic, 62, 63, 64
  - Schorr and Waite algorithm, 617–621
  - for searching key using bit-tree leaf, 320
  - sorting, 123
  - sources affecting efficiency of, 633
  - stop-and-copy algorithm, 623, 625, 633
  - straightforward string matching, 649–652
  - Sunday algorithms, 668–670
  - Tarjan’s algorithm, 403
  - Ukkonen algorithm, 689–692, 704
  - Wagner-Fischer algorithm, 696–698
  - WFI algorithm, 390, 392, 461
  - Yuasa’s algorithm, 630–632
  - Ziv-Lempel algorithm, 588–589
- alignments, 694
- alternating path, 422
- American Standard Code for Information Interchange (ASCII) code. *See* ASCII code
- amortized complexity, 69–73, 110, 265–267
- amortized cost, 71–73, 110
  - of access in splaying, lemma specifying, 265
  - estimating, 72
  - of single operations, 110

- analysis, amortized, 69–73
- anchor, 169, 175, 186
- approximate string matching, 694–704
  - string matching with  $k$  errors, 701–704
  - string similarity, 695–701
- arcs, 214, 376
  - in decision trees, 479
- array indexes, 106
- array list, 338
- ArrayList class, 120–123
  - list of methods, 120–122
  - methods, program demonstrating operation, 122–123
- arrays, 15–16. *See also* sorting
  - advantages of, over linked lists, 123
  - calculating sum of numbers in, 64–66
  - flexible. *See* vectors
  - heaps implemented by, 267–269
  - implementation of queues in, 151, 152
  - implementing trees as, 219
  - of numbers, 93
  - ordered, 65
  - organizing, as heaps, 272–275, 273
  - overcoming limitations of, 123
  - parallel two-dimensional, 112, 113, 114
  - pseudoflexible, 359, 360
  - of references, 106
  - of references to subtrees, 349, 351
  - and sparse table for storing student grades, 112
  - stack implementation as flexible, 146
  - for storing items, 14
  - transformed into heaps, 485, 486
  - unordered, 67
- articulation points, 400
- artificial intelligence, 191
- ASCII code, 579, 581, 586
  - used in sorting, 469
  - values in, 522
- ASCII codes, 50, 319
- assignment operators, 4
- assignment problem, 428–430
- assignments
  - for nodes, 82
  - value, 4
- assignment statements, 64–66
- asymptotic complexity, 57
  - imprecision of, 633
- augmenting path, 422, 424
- avail-list, 621
- average case assessment, 66–69
- average path length, 222
- AVL trees, 107, 255, 255–260, 258
  - rebalancing, after deleting node, 259
  - transforming, into vh-trees, 337, 337
- backbone, 253–255
  - transforming binary search tree into, 253
  - transforming, into perfectly balanced tree, 254
- back edges, 392
- backtracking, 158, 159, 191–198
  - in graphs, 379
- Backus-Naur form (BNF), 171
- Baker’s algorithm, 625–627
  - modification to, 627
- balanced trees, 249
- Bank One, 154–157
  - customer data example, 155
  - example: implementation code, 156–157
- base class, 20
- BASIC
  - compiler in, 604
  - speed of, 56
- Bessel functions, 249
- best case assessment, 66–69
- best-fit algorithm, 605
- biconnected components, 400
- biconnected graphs, 400
- big-omega notation, 61–62
- big-O notation, 57–61, 470
  - calculation according to definition of, 58
  - estimates, typical functions applied in, 63
  - inherent imprecision of, 59
  - possible problems, 62
  - properties of, 59–61
- binary buddy system, 608–613, 610
- binary code, 570, 572
- binary file, 26
- binary search, 123, 250, 519, 693
  - algorithms, 65
  - average case for, 67–69
  - nondeterministic version, 73–74
- binary search algorithm, 65
- binary search trees, 217–218, 218, 249. *See also* 2–4 trees
  - comparing tries with, 352
  - creating, from ordered array, 251
  - deleting nodes in, 242–249
  - as an encumbrance, 301
  - implementation of generic, 220–221
  - inserting nodes into, 240
  - property of, 217–218
  - searching, 221–223
  - transforming, into backbone, 253
- binary trees, 214–288. *See also* trees
  - balanced, 249
  - defined, 216
  - heap properties of, 485
  - heaps, 267–275
  - height-balanced, 249
  - implementing, 219–221
  - important characteristic of, 217
  - inserting nodes in, 239–242
  - ordered, 217
  - perfectly balanced, 249
  - red-black trees, 324
  - representing 2–4 trees as, 324
  - searching, 239
  - sorting algorithms expressed in terms of, 477–478
  - top-down or bottom-up creation of, 277
  - tries implemented as, 354
  - vh-trees, 324–327
- bipartite graphs, 421, 424, 536
- bits, 42
  - strings of, 672
- bit-trees, 319, 319–320
- bivariate integral equations, 249
- black pointers, 324
- blocks, 300
  - algorithm for allocating, 607

- in graphs, 400
    - in Huffman trees, 582
    - memory, 605
  - blossoms, 431
  - Bn*-trees, 313
  - Boolean arguments, 5
  - Boolean conditions, 6
  - Boolean expressions, 6, 447
    - in conjunctive normal form (CNF), 75
    - satisfiable, 75
  - Boolean methods, 93
  - Boolean value, 5
  - Boolean variables, 75
  - Boruvka's algorithm, 462
  - boundary folding, 520–521
  - boundary path, 689
  - bounds, 488–494
    - finding best, 494
    - selecting, 489
  - Boyer-Moore algorithm, 660–668, 671
  - Boyer-Moore-Galil algorithm, 671
  - breadth-first search, 381, 382, 412, 413, 424, 430
  - breadth-first traversal, 224, 582, 623, 625, 634, 678
    - copying lists using, 623
    - implementation, 224
  - Brelaz algorithm, 444–445
  - bridge, in graph, 400, 433
  - $B^{**}$ -trees, 313
  - $B^*$ -trees, 312–313
  - $B^+$ -trees, 313–316, 314
  - $B$ -trees, 301–337
    - building, 323
    - deleting keys from, 309–311, 310
    - family of, 300–337
    - free-at-empty, 372–374
    - important property of, 301–302
    - inserting keys, 305–309
    - merge-at-half, 372–374
    - merging in, 309
    - of order 4. *See* 2–4 trees
    - of order  $m$ , properties of, 302
    - searching, 304–305
    - splitting, 305–307, 309
  - bubble sort, 475–477, 479, 483, 506
  - bucket addressing, 530–531
  - buckets, 541–544. *See also* bucket addressing
    - hashing with: case study, 557–565
    - splitting, 541
  - buddy systems, 608–615
  - bytecodes, 144
    - index, 145
  - bytes, 43, 49
    - files as collections of, 42
    - reading and writing, 26–27
    - sequence of, 26
    - used to specify separators, 319
  - C, 2, 15
    - library, 12
    - pointers in, 35
    - speed of, 56
    - unused memory in, 604
  - C++, 2, 15
    - library, 12
    - pointers in, 35
    - shifting responsibility to garbage collector in, 624
    - unused memory in, 604
  - canonical node, 704, 706
  - canonical reference, 704
  - capacity, of edge, 407
  - Cartesian plane, 320
  - case studies:
    - adding polynomials, 507–514
    - computing word frequencies, 280–288
    - distinct representatives, 450–459
    - exiting a maze, 158–163
    - hashing with buckets, 557–565
    - Huffman method with run-length encoding, 590–600
    - in-place garbage collector, 634–635
    - library, 124–133
    - longest common substring, 704–712
    - random access file, 42–50
    - recursive descent interpreter, 199–206
    - spell checker, 358–368
  - cellar, 529
    - coalesced hashing using, 530
  - chaining, 528, 528–530
  - characters, 2
    - literal, 3
    - non-Latin, 2
  - sequence of, 26
  - sequences of blank, 42–43
  - Unicode, 1, 3
- cheapest insertion algorithm, 463
  - children, on trees, 214, 299. *See also* nodes
    - deleting nodes with, 243
  - Chinese postman problem, 434
    - solving, 435
  - chromatic number, 443
  - Cichelli's method, 533–536
  - circuit, 377
  - circular lists, 99–101, 393, 501
    - doubly linked, 101
    - inserting nodes, 100
    - singly linked, 99
  - class(es)
    - abstract, 17
    - base, 20
    - buffered, 24
    - building, 42
    - creating hierarchy of, 18
    - derived, 20
    - filtered, 24
    - generic, 14
    - implementation of interfaces by, 17
    - legacy, 35
    - methods, 12–13
    - nonderived, 20
    - pipelined streams, 24
    - variables, 12–13
    - wrapper, 16, 23
  - class declaration, 10
    - program, 10
  - class methods, 12–13
  - class scope variables, 8
  - class type, 1
  - class variables, 12–13
  - clique, 445
  - cloning, 33, 33–34, 41
  - clusters, in hashing, 523, 525
  - coalesced hashing, 529, 529
  - coalescing process, 605, 611–614, 612, 614
  - COBOL, 604
  - cocktail shaker sort, 483, 515
  - collision resolution, 522–531
    - bucket addressing, 530–531
    - chaining, 528–530
    - open addressing, 522–526, 528
  - collisions, 520



- compaction, 621–622
    - data. *See* data compression
    - heap, 623
  - compilation, 199
  - compilers, 199, 276, 604
    - generating code in, 278
    - symbol tables in, 519
  - complement graphs, 448
  - complete binary trees, 217
  - complete graphs, 377
  - complexity analysis, 56–75
    - amortized complexity, 69–73
    - best, average, and worst cases, 66–69
    - big-O notation, 57–61
    - computational and asymptotic complexity, 56–57
    - examples of complexities, 62–64
    - finding asymptotic complexity: examples, 64–66
    - NP-completeness, 73–75
    - omega and theta notations, 61–62
    - possible problems, 62
  - compound statements, 1
  - compression
    - adaptive, 582
    - of tries, 355, 355–358
  - compression rate, 355, 572
  - computational complexity, 56–57
  - computing word frequencies: case study, 280–288
    - implementation, 282–287
    - semisplay tree used for, 281
  - conditional operators, 5
  - conjunctive normal form (CNF), 75
  - connected graphs, 399–400
  - connectivity, 399–405
    - in directed graphs, 402–403, 405
    - in undirected graphs, 399–400, 402
  - constant algorithm, 62, 63
  - constants, 17
  - constructors, 30
    - in nodes, 82
  - copying methods, of garbage collection, 623–628, 633
  - count method, of organization, 107–110
  - Cray computers, 56
  - C-tries, 356–358
  - cubic algorithm, 63, 64, 393
  - cut-edge, 400
  - cuts, 408
  - cut-vertices, 400
  - cycle, 377
  - cycle detection, 392–393
  - dangling reference problem, 34
  - data
    - final ordering of, 469–470
    - secondary storage, processing, 299
    - spatial, 320
    - transferral, 570
  - data compression, 570–593
    - conditions for, 570–572
  - data encapsulation, 8
  - data fields, 8
    - with no access modifier, 21
    - in nodes, 82
    - nodes containing, referencing other nodes, 80
  - data structures
    - composed of nodes, 80
    - with contiguous block of memory. *See* vectors
  - equalizing, 41
  - graphs as versatile, 376
  - linear, 140. *See also* stacks and object-oriented programming (OOP), 42
  - sophisticated, 106–107. *See also* trees
  - for spatial data, 320
  - spell checker, 358
  - subject to sequence of operations, 69
- data types, reading and writing primitive, 29
  - D-bits, useful properties of, 319
  - decision problems, 74
  - decision statements, 5–6
  - decision trees, 217, 477–480, 480. *See also* sorting
  - declaration, 26
    - class, 10–12
    - for nodes, 82
  - default modifier, 12
  - degree of vertex, 377
  - deleting by copying, 246–249, 248, 331–332
    - implementation of algorithm for, 247
  - deleting by merging, 243–246, 245, 246
    - implementation of algorithm for, 244–245
    - summary of, 244
  - deletion
    - AVL trees, 258–260
    - binary search trees, 242–249, 309
    - B<sup>+</sup>-trees, 314, 316
    - B-trees, 309–311, 310
    - by copying, 246–249, 331–332
    - doubly linked lists, 98
    - in hashing, 531–532
    - linked lists, 88, 88–93, 90, 92, 98, 99
    - by merging, 243–246
    - prefix B<sup>+</sup>-trees, 316
    - sets, 338
    - simple prefix B<sup>+</sup>-trees, 316
    - 2–4 trees, 327
    - vh-trees, 331–332, 333–337, 335
  - delimiters, 1
    - matching, 141
  - dependency graph, 536
  - depth-first search, 379–382, 393, 395, 400, 405, 409–412, 414, 431
    - adapted to topological sort, 405–406
  - depth-first traversal, 225–231, 634, 693
    - implementation, 226
    - stackless, 231–235
    - tasks of interest in, 225
  - depth, of directory, 539, 540
  - deques, 388–389
  - dequeuing, 149, 150, 151, 153
    - algorithm, 270
    - elements from heaps, 269–270, 271
  - derived classes, 20
  - D’Esopo-Pape algorithm, 388, 460
  - deterministic algorithms, 73–74
  - differentiation, 279
  - digital trees, 370

- digraphs, 376. *See also* directed graphs; networks
  - depth-first search in, 381
  - linearizing. *See* topological sort
- Dijkstra's algorithm, 384–386
  - label-correcting version of, 390
  - modified, 419
- Dijkstra's method, 399, 464
- diminishing increment sort. *See* Shell sort
- Dinic's algorithm, 414, 415, 416–417
- directed graphs, 376. *See also* digraphs
  - connectivity in, 402–403, 405
- directories, 538–541
  - depth of, 539, 540
- disks, 300
- distinction bits. *See* D-bits
- distinct representatives: case study, 450–459
  - problem, implementation, 454–459
- division, in hashing, 520
- dot notation, 35
- double hashing, 526, 527, 528
- double-O (*OO*) notation, 62
- doubly linked lists, 95, 95–99, 575, 582–583, 605, 608, 634
  - circular, 100
  - deleting nodes, 98, 98
  - implementation, 96
  - inserting nodes, 97, 98
- DSW algorithm, 252–255
- dual buddy system, 615
- dynamic binding, 21, 22
- dynamic hashing, 538
- echoprinting, 150
- edges, weights assigned to, 376, 383
- edit table, 696
- efficiency
  - of algorithms, using big-O notation to estimate, 59–61
  - best, average, and worst cases, 66–69
  - criteria, 56
  - of heap sort, 488
  - of prefix B<sup>+</sup>-trees, 317
  - of recursion, 198–199
  - searching, improving, 107
  - of searching in binary trees, 223
  - of skip lists, 106–107, 110
  - of traversal procedures, 239
- Eiffel, 604
- eight queens problem, 191–198, 192, 195, 197–198
- implementation, 194
- encapsulation, 8–16
  - arrays, 15–16
  - class methods and class variables, 12–13
  - generic classes, 14
  - wrapper classes, 16
- endpoint, 690
- enqueueing, 149, 150, 151, 153
  - algorithm, 269
  - elements to heaps, 269, 270, 272
- entries, map, 344, 349
- entropy, 570
- entry table, 627–628
- equality operator, 43
- error messages, 6–7
  - run-time, 15
- Eulerian cycle, 432, 433
- Eulerian graphs, 432–435
  - Chinese postman problem, 434
- Eulerian trail, 432
- exact string matching, 649–692
  - bit-oriented approach, 672–675
  - Boyer-Moore algorithm, 660–668
  - Knuth-Morris-Pratt algorithm, 652–659
  - matching sets of words, 676–682
  - multiple searches, 670–672
  - regular expression matching, 682–686
  - straightforward algorithms, 649–652
  - suffix arrays, 693–694
  - suffix tries and trees, 686–692
  - Sunday algorithms, 668–670
- exceptions
  - catching, 145
  - handling, 6–8
  - throwing, 25, 89–90
- excessive recursion, 188–191
- exiting a maze: case study, 158, 158–163
  - algorithm pseudocode for, 159
  - example of processing maze, 160
  - program for maze processing, 161–163
- expandable hashing, 538
- expected value, 66
- explicit cast, 2
- exponential algorithm, 63
- expression trees, 276, 276–277, 279
  - operations on, 277–280
- Extended Binary Coded Decimal Interchange Code (EBCDIC), 469
- extendible hashing, 538, 539, 539–541
- external fragmentation, 605, 612, 615
- extraction, in hashing, 521
- factorial function, 170
- farthest insertion algorithm, 463
- fastmark algorithm, 620
- fax images, 587
- FHCD algorithm, 536–538
- Fibonacci buddy system, 613
- Fibonacci numbers, 188–191, 199
  - algorithms for calculating, 191
  - calculating, 190
- Fibonacci words, 659
- fields, 8, 49
  - initialization of, 82
- FIFO (first in/first out) structures, 149. *See also* queues
- files, 42, 49
  - binary, 26
  - text, 26
- fill factor, 313
- final variables, 17
- first-fit algorithm, 605
- fixed-length records, 43
- flag flipping, 328, 330–331
- Fleury's algorithm, 433
- flexible arrays, 35
- floating garbage, 632
- floating-point literals, 3
- floating-point numbers, 3, 4, 202
- float numbers, 93
- flow, 407–408
- flow-augmenting path, 408
- flower, on blossom, 431
- folding, 520–521
- Ford-Fulkerson algorithm, 408–414, 410–411, 413, 417
- Ford's algorithm, 386–388

- forest, 380
- Forth, use of postfix notation by, 277
- FORTRAN, 604
- forward edges, 381
- 4-nodes, 324
- fraction of data reduction, 572.
  - See also* compression rate
- frames, 145
- free-at-empty B-trees, 372–374
- fromspace, 625
- full suffix rule, 662
- functional languages, 9
- functions
  - complex, 56–57
  - defined in a class, 8
  - factorial, 170
  - f* growth rate of all terms of, 57
  - recursive, 174
- garbage collection, 615–632
  - copying methods, 623–628, 633
  - decreasing cost of, 623–624
  - incremental garbage collection, 625–632
  - marking phase, 616–621
  - noncopying methods of, 629–632
  - reclamation phase, 621
- garbage collector, 34, 88, 92, 98, 242, 615–616
- generalized Fibonacci system, 613
- generational garbage collection, 627, 633
  - Lieberman-Hewitt technique of, 629
- generic classes, 14
- Godel numbers, 167
- graphs, 376–459, 377
  - connectivity, 399–405
  - cycle detection, 392–393
  - defined, 376
  - Eulerian graphs, 432–435
  - graph coloring, 442–445
  - Hamiltonian graphs, 436–437
  - matching, 421–432
  - networks, 407–421
  - NP-completeness problems in graph theory, 443, 445–449
  - representation, 377–379
  - shortest paths, 383–392
  - spanning trees, 380, 395–396, 399
  - topological sort, 405–406
  - traversing. *See* graph traversals
- graph traversals, 379–382
- ground case, 169
- Hamiltonian cycle, 436–437, 438
  - problem, 449
- Hamiltonian graphs, 436–437
- traveling salesman problem (TSP), 438–442
- Hancart’s algorithm, 651–652
- hash function, 338
- hash functions, 519, 520–522, 590
  - division, 520
  - for extendible files, 538–544
  - extendible hashing, 539–541
  - extraction, 521
  - folding, 520–521
  - linear hashing, 541–544
  - mid-square function, 521
  - radix transformation, 522
- hashing, 519–557
  - with buckets: case study, 557–565
  - collision resolution, 522–531
  - deletion, 531–532
  - hash functions, 520–522
  - hash functions for extendible files, 538–544
  - in java.util, 544–557
  - perfect hash functions, 532–538
  - using buckets, implementation, 559–565
- HashMap, 544–557
  - demonstrating operation of methods in class, 546–547
  - methods in class, 545
- HashSet, 547–552
  - demonstrating operation of methods in class, 549–551
  - methods in class, 548–549
- hash table, 338
- Hashtable, 552–557
  - methods of class, 552–553
  - methods, program demonstrating operation of, 554–556
- heap, memory, 604, 605, 607, 633
  - compaction, 623
- heap property, 267
- heaps, 267–275, 268, 385, 575–579. *See also* heap sort
  - implemented by arrays, 267–269
  - organizing arrays as, 272–275, 273
  - as priority queues, 269–271
  - properties of, 485
- heap sort, 484–488
- height
  - balanced trees, 249
  - of empty and nonempty trees, 214
  - maximum number of nodes in binary trees of different, 250
  - tree, extension or reduction after deletion by merging, 246
  - of tries, determining, 351, 352
  - of vh-trees, 326
- height-balanced trees, 249
- hexadecimal notation, 570
- hiding, 9
- horizontal pointers, 324, 325
- Huffman algorithm, 572–573
  - implemented with heap, 578
- Huffman coding, 572–581
  - adaptive, 581–586
- Huffman method
  - implementation, 593–600
    - with run-length encoding: case study, 590–600
- Huffman trees, 573, 574, 575–581
- Hungarian tree, 424, 431
- Hunt-Szymanski algorithm, 699–701
- identifiers, 28
- implementation
  - array, of list, 120–123
  - of Java by Microsoft, 32
  - of Java by Sun, 32
  - program, 16
  - skip list, 103–105
- incidence matrix, 378, 379
- incremental garbage collection, 625–632
  - copying methods in, 625–628
- indexes, 519
  - array, 106
  - of buckets, 538
  - bytecode, 145
- index set, 313, 314
  - of B<sup>+</sup>-tree, 316

- indirect recursion, 185–187
- infix notation, 277
- information-hiding principle, 9, 20
- inheritance, 18–21
- initialization, 64, 65
  - of fields, 82
- inorder tree traversal, 225–230, 227, 228, 313
  - changes in run-time stack during, 229
  - generation of infix notation by, 277
  - Morris algorithm for, 236–237, 237
  - nonrecursive implementation of, 232
- in-place garbage collector: case study, 634–635
  - implementation, 637–642
- input and output, 24–31, 41
  - buffered, 27
  - random access files, 30–31
  - reading and writing bytes, 26–27
  - reading and writing objects, 29–30
  - reading and writing primitive data types, 29
  - reading lines, 27
  - reading tokens: words and numbers, 28
- insertion
  - AVL tree, 256–258
  - binary search trees, 240
  - binary trees, 239–242
  - B<sup>+</sup>-trees, 312
  - B<sup>+</sup>-trees, 314
  - B-trees, 305–309
  - doubly linked lists, 98
  - linked lists, 86, 86–88, 87, 97, 98, 100
  - R-trees, 321
  - sets, 338, 340
  - simple prefix B<sup>+</sup>-trees, 316
  - threaded trees, 242
  - tries, 352
  - 2–4 trees, 327
  - vectors, 41
  - vh-trees, 330–331
- insertion sort, 470–473, 479, 483, 494, 497, 505–506
- instance methods, 12
- instance variables, 12
- integer literals, 3
- integer operations, 2
- integers, 14, 42
  - list that stores, 115
  - literal, 3
  - short, 114
  - sorting, 497–498
  - storing, 93
  - unsigned, 2, 25
- interfaces, 16, 17, 22
  - relaxation of rigidity of, 17
- internal fragmentation, 605, 615
- internal path length (IPL), 222, 248
- Internet, bytecodes received through, 144
- interpretation, 199
- interpreter, 145
  - implementation of simple language, 203–206
  - need for, to execute bytecodes, 144
  - recursive descent: case study, 199–206
  - sample, for limited programming language, 199–206
- intractable problems, 74
- inversion, 109–110
- ISBN code, 521
- iteration
  - use in real-time systems, 198–199
  - use of, versus recursion, 198–199
- iterators, example of application of, 118–119, 128–133
- Jarnik-Prim algorithm, 440, 462, 464
- Java
  - case sensitivity in, 1
  - decision statements, 5–6
  - delimiters in, 141
  - equivalent of factorial, 171
  - exception handling, 6–8
  - implementation of selection sort, 474
  - important difference between C/C++ and, 2
  - loops, 6
  - operators, 4–5
  - and pointers, 31–35
  - representing polynomials in, 507
  - rudimentary, 1–8
  - variable declarations, 1–4
- Java stack, 172
- java.util
  - ArrayList class, 120–123
  - hashing in, 544–557
  - HashSet, 547–552
  - Hashtable, 552–557
  - LinkedList class, 114–120
  - sorting in, 502–505
  - stacks in, 148–149
  - TreeMap, 344–349, 345–347
  - TreeSet, 338–340, 338–344, 341–343
  - Vector, member functions in, 36–39
  - vectors in, 35–41
- Java Virtual Machine (JVM), 172
  - stack used by, 144–145
- k*-colorable, 443
- Kershenbaum's algorithm, 460
- keyboard, 24, 25
- keys, 301
  - comparison of, 519
  - deletion from B-trees of, 309–311, 310
  - insertion into B-trees of, 305–309
  - separator, 316
  - in tries, 349
  - used in maps, 344
- Kleene closure, 682
- Knuth-Morris-Pratt algorithm, 652–659, 679–680
- Kruskal's algorithm, 396–399, 464
- Kuhn-Munkres algorithm, 428–429
- label-correcting methods, 383–390
- label, in network, 408, 419
- label-setting methods, 383–390
- largest first algorithm, 444
- last-come-first-served hashing, 567
- latency, 300
- layered network, 414, 416
- leaders, 582
- leaves, 214, 217
  - adding, to trees, 218
  - of bit-trees, 319
  - in B<sup>+</sup>-trees, 313

- in decision trees, 479
  - deleting, 242
  - or nonleaves, merging in B-trees, 309
  - of tries, 349
- left side occurrence rule, 661
- legacy class, 35
- length of path, 214
- level network. *See* layered network
- level, of nodes, 214
- Levenshtein distance, 695, 698
- lg, 61
- library case study, 124–133
  - library program, 128–133
  - linked lists indicating library status, 125
- LIFO (last in/first out) structures, 140. *See also* stacks
- linear algorithm, 63
- linear hashing, 538, 541–544
- linear probing, 522–523, 526, 527, 528
- lines, reading, 27
- LinkedList class, 114–120
  - list of methods, 116–118
- linked lists, 80–133, 573
  - advantages of arrays over, 123
  - circular lists, 99–101, 393
  - doubly linked lists, 95, 95–99
  - drawback of, 101
  - implementation of queues in, 153
  - implementing stack as, 146–147, 147
  - indicating library status, 125
  - in java.util, 114–120
  - library program, 128–133
  - of  $n$  elements, searching, 216
  - scanning, 90, 91, 95
  - searching, 93
  - self-organizing lists, 107–111
  - singly linked lists, 80–86, 81
  - skip lists, 101–107
  - sparse tables, 111–114
  - student grades implemented using, 115
- linked structures, 80. *See also* linked lists
- LISP, 9
  - automatic storage reclamation in, 604
  - files, 593
  - forward references in, 627
  - garbage collection in, 615
  - read barrier in, 633
  - speed of, 56
  - use of prefix notation by, 277
- listings, 694
- literals
  - floating-point, 3
  - integer, 3
- literal strings, 24
- loading factor, 527, 542
- local depth, in hashing, 540
- logarithmic algorithm, 63
- logarithmic function, 60–61
- LOGO, use of prefix notation by, 277
- longest common substring: case study, 704–712
- listing of program to find, 707–711
- loops, 6, 64–66
  - infinite, 379, 623, 634
  - nested, 6
  - for printing vectors safely, 41
  - relation of tail recursion to, 178–179
  - required for deletion of tail node in circular list, 100–101
  - in singly linked lists, 95
- LZ77, 587–588, 588
- LZW, 588–589, 589
- maps, 344, 347, 349. *See also* tables
- mark-and-sweep, 616, 629–630, 633
- marking, in garbage collection, 616–621
- Markov chains, theory of absorbing, 650
- marriage problem, 422
- matching, 421–432, 423
  - assignment problem, 428–430
  - in nonbipartite graphs, 430–432
  - stable matching problem, 426–428
- matching problem, 422
- matchlist, 699
- matrix, 378
- max-flow min-cut theorem, 408
- max-flow problem, 408
- max heap, 267
- maximum-flow problem, 408
- maximum flows, 407–417
  - of minimum cost, 417–421, 420
- maximum matching, 421–422
- member functions
  - program demonstrating operation of vector, 40
  - vector, 36–39
- memory
  - data structure with contiguous block of. *See* vectors
  - dynamic allocation of necessary amounts of, 123
  - nodes located anywhere in, 80
- memory cells
  - currently in use, 616
  - unused, 615
- memory management, 604–633
  - nonsequential-fit methods, 606–615
  - sequential-fit methods, 605–606
- memory manager, 604–605
  - returning unneeded space to, 34
- merge-at-half B-trees, 372–374
- mergesort, 494–497, 496, 516
- merging
  - in B-trees, 309
  - deleting by, 243–246
- message passing, 11
- method calls, 172, 179
  - and recursion implementation, 172–174
- method prototypes, 17
- methods, 8
  - application of TreeMap, 348
  - arrays passed to, by reference, 15–16
  - Boolean, 93
  - class, 12–13
  - of class TreeMap, 345–347
  - of class TreeSet, 338–340
  - instance, 12
  - list of, in class LinkedList, 116–118
  - with no access modifier, 21
  - nonstatic, 12
  - Microsoft, 32
  - mid-square hash function, 521
  - min heap, 267, 575–576
  - minimal vertex, 405

- minimum spanning trees, 396, 399, 439
- modifiers, 2
  - default, 12
- Modula-3, 604
- monitor, 24
- Morris algorithm, 236–239, 237, 240
- Morse code, 570
- move-to-end method, 135
- move-to-front method, of organization, 107–110
- multigraphs, 376, 379
- multiway Patricia trees, 372
- multiway search tree of order  $m$ , 299
- multiway tree of order  $m$ , 299
- multiway trees, 299–358. *See also specific trees*
- mutators, 625, 627, 630
- $m$ -way search tree, defined, 299
- $m$ -way trees, 299
  
- natural sort, 516
- $n$ -connected graphs, 400
- nearest addition algorithm, 441
- nearest insertion algorithm, 463
- nearest neighbor algorithm, 463
- nearest merger algorithm, 464
- negative cycle, 383
- nested loops, 6, 64, 65
- nested recursion, 187
- networks, 407–421
  - defined, 407
  - maximum flows, 407–417
- next-fit method, 605–606
- Nicod's axiom, 291
- nodes
  - on B-trees, 302
  - data fields in, 82
  - definition of, 82
  - deleting, in binary search trees, 242–249
  - deleting, in linked lists, 88, 88–93, 90, 92, 98, 99
  - deletion of tail, 100–101
  - inserting, in binary trees, 239–242
  - inserting, in linked lists, 86, 86–88, 87, 97, 98, 100
  - located anywhere in memory, 80
  - maximum number, in binary trees of different heights, 250
  - in  $m$ -way search trees, 299
  - in skip lists, 102
  - in trees, 214
  - types of, in tries, 352
- non-object-oriented languages, 8
- nonbipartite graphs, 430–432
- noncopying methods, of garbage collection, 629–632
- nonderived classes, 20
- nondeterministic algorithms, 73–74
- nondeterministic finite automaton (NFA), 683–686
- nonsequential-fit methods, 606–615
- nonsequential searching, 101
- nonstatic methods, 12
- nonstatic variables, 12
- nontail recursion, 179–185
- no occurrence rule, 661
- normalization function, 522
- notation, 649
- NP-completeness, 73–75
  - clique problem, 445–446
  - Hamiltonian cycle problem, 449
  - problems in graph theory, 443, 445–449
  - 3-colorability problem, 446–448
  - vertex cover problem, 448–449
- null reference field, 80
- null suppression, 587
- numbers, 28
  - represented in binary form in computers, 570
  - stored in binary form, 50
  
- $O(n \lg n)$  algorithm, 63
- Objective-C, 17
- object-oriented programming (OOP), 8–50
  - abstract data types, 16–17
  - data structures and, 42
  - encapsulation, 8–16
  - inheritance, 18–21
  - input and output, 24–31
  - polymorphism in the context of, 21–24
  - random access files, 30–31
- roots of, in simulation, 9
- vectors, 35–41
- objects
  - abandoning unneeded, 34
  - compound, 340
  - creation of, 8
  - in OOL, 9
- organizing hierarchical representation of. *See trees*
  - reading and writing, 29–30
  - referred to, contents of, 23
  - self-referential, 82
  - simple, 340, 343
  - specification of, 10
- open addressing, 522–526, 528
- operand stack, 145
- operations
  - integer, 2
  - performing user-defined, 115, 119
  - precisely specified, 16
- operators, 4–5
  - assignment, 4
  - conditional, 5
  - equality, 43
  - prefix and postfix, 4
- optimal assignment problem, 428
- optimal code, 571–572
- optimal-fit method, 643
- optimal static ordering, 107
- ordered binary trees, 217
- ordering method, of organization, 107–110
- orderly trees, 216
  
- packages, 12
- parsing, 200, 202
- partial suffix rule, 662
- partition approach, 703
- Pascal, 9, 34
  - cross-reference program, 535
  - like languages, 9
  - shifting responsibility to garbage collector in, 624
  - unused memory in, 604
  - path, 214, 376
  - finding shortest, in graph theory, 383
- Patricia trees, 372 n, 373
- pattern matching, 649
- PCs, 56

- perfect hash functions, 519, 532–538
  - Cichelli's method, 533–536
  - FHCD algorithm, 536–538
- perfectly balanced trees, 249, 254
- perfect matching, 422
- periods, 671
- piped streams, 24
- pivots, 488
- platform independent, 26
- pointers, 31–35
  - horizontal and vertical, 324
  - red and black, 324
- point quadtrees, 370
- Polish notation, 275–277
- polymorphism, 21–24
- power of, 22
- polynomials, 60
  - adding: case study, 507–514
- postfix notation, 277
- postfix operators, 4
- postorder tree traversal, 225, 230–231, 440
  - generation of postfix notation by, 277
  - nonrecursive implementation of, 232
  - nonrecursive version of, 231
  - threaded trees used for, 235
- PostScript, use of postfix notation by, 277
- potential, 71–73
- prefix B<sup>+</sup>-trees, 316–318, 318
- prefix notation, 277
- prefix operators, 4
- prefix property, 571
- preorder tree traversal, 225, 230–231, 440
  - generation of prefix notation by, 277
  - nonrecursive implementation of, 230
  - threaded trees used for, 235
- priority queues, 157–158, 573, 575
  - heaps as, 269–271
- probability distribution, 66–67
- probe, 522
- probing function, 522, 523
- problems
  - intractable, 74
  - NP-complete, 74
  - tractable, 74
- Prolog, 179
  - automatic storage reclamation in, 604
- protocols, 17
- pseudographs, 376
- pseudokeys, 539
- public information, 9
- quadratic algorithm, 62, 63, 64
- quadratic probing, 525, 527, 528
- qualifiers, 24
- quaternions, 53
- queues, 149–157, 412, 416, 424–425, 498–501
  - array implementation of, 150–151, 151, 152
  - in graphs, 381, 388
  - linked list implementation of, 153
  - operations executed on abstract, 154
  - operations needed to manage, 149
  - piles organized as, 498
  - priority, 157–158
  - series of operations executed on, 150
  - used in breadth-first traversal, 224
  - used in simulations, 153
- queuing theory, 153
- quick-fit method, of memory allocation, 644
- quicksort, 488–494, 506, 558
  - implementation, 489–490
- radix sort, 497–501, 499, 506
- radix transformation, 522
- random access, 123
  - of references stored in arrays, 353
- random access files, 30–31
  - case study, 42–50
- program to manage, 44–49
- read barrier, 627, 629
- reading
  - bytes, 26–27
  - input, 25
  - lines, 27
  - objects, 29–30
  - primitive data types, 29
  - records, methods for, 50
  - from standard device, 24
  - tokens: words and numbers, 28
- real-time systems, use of iteration in, 198–199
- records, 49
  - fixed-length, 43
  - methods for reading and writing, 50
- recursion, 169–206, 226, 251, 489, 495
  - anatomy of recursive call, 174–178
  - backtracking, 191–198
  - double, 225
  - efficiency of iteration versus, 198–199
  - excessive, 188–191
  - implementation, method calls and, 172
  - indirect, 185–187
  - as natural implementation of backtracking, 191
  - nested, 187
  - nontail, 179–185
  - power of, 231
  - recursive definitions, 169–172
  - replacing, with iteration in mergesort, 497
  - tail, 178–179
- recursive definitions
  - parts of, 169
  - purposes of, 170
  - of sequences, undesirable feature of, 170–171
  - uses of, 171
- recursive descent, 200, 277
- recursive descent interpreter
  - case study, 199–206
  - diagrams of methods used by, 201
- red-black trees, 324, 325
  - maps implemented as, 344
  - used for implementation of sets, 338
- redistribution, in B-tree, 309
- red pointers, 324
- reducibility, 74
- reduction algorithm, 74
- reduction function, 74
- reference count method, of
  - garbage collection, 643–644
- reference fields

- having different numbers of, 101
- for nodes in trees, 233
- null, 80
- per node, 106
- trees and, 219
- two-dimensional, 93
- references, 31–35, 82
  - inconvenience of using, 83
  - permanent, in circular linked list, 99–100
  - in red-black trees and vh-trees, 324
  - singly linked lists of, 573
  - split, 541–542
  - storing, to nodes, 80
  - in trees, 233
  - in tries, 351
  - updating, 623
- reference variables, 31–35
  - object, 32
- relational databases, 587
- right side occurrence rule, 661
- Robin Hood hashing, 567
- root, of SCC, 403
- root pointers, 615
- root set, 615
- roots, tree, 214
- rotation, 252–255, 261
  - of child about parent, 252
- rotational delay, 300
- R<sup>+</sup>-trees, 321–322
- R-trees, 320–322, 322
- run-length encoding, 586–587
  - candidates for compression using, 587
  - Huffman method with: case study, 590–600
- runs, 516
  - defined, 586
- run-time stacks, 172, 199. *See also* stacks
  - changes to, 177
  - contents, 174
  - for eight queens problem, 196
  - during inorder traversal, 229
  - overflow of, 616
  - reliance of recursive traversals on, 239
  - in tree traversal, 225, 228–231
- satisfiability problem, 75
- saturation degree, of vertex, 444
- scatter tables, 528
- Schorr and Waite algorithm, 617–621
  - example of execution of, 618–619
- searching
  - binary search trees, 221–223
  - binary trees, 239
- bit-tree, 319–320
- B-trees, 304–305
  - compressed tries, problem with, 356
  - improving efficiency of, 107
  - linked list of *n* elements, 216
  - linked lists, 93, 102–107
  - nonsequential, 101
  - process, speeding up, 107
  - process, tree operations that accelerate. *See* trees
  - R-tree, 321
  - sequential, 43, 49, 67, 107, 519
  - skip lists, 102–103, 105–106
  - tree sets, 344
- 2–4 tree, 325–326
- secondary clusters, 525, 526
- secondary storage
  - decrease in speed related to, 299
  - relation of B-trees to, 301–303
- seektime, 300
- selection sort, 474–475, 475, 479, 484, 506
- self-adjusting trees, 107, 260–267
  - self-restructuring trees, 261–262
  - splaying, 262–267
- self-organizing lists, 107–111, 108, 111
  - count method, 107–110, 108, 111
  - methods for organizing, 107
  - move-to-front method, of organization, 107–110
  - ordering method, 107–110, 108
  - sample runs, 111
  - transpose method, 107–110, 108, 111
- self-referential objects, 82
- self-restructuring trees, 261–262
- semispaces, 623
  - fromspace and tospace, 625
- semisplaying, 263, 266–267, 267, 281
- separate chaining, 528
- sequence set, 313
- sequential coloring, 443
- sequential-fit methods, 605–606
- sequential scanning, 101, 353
- sequential searching, 43, 49, 67, 107, 519
- sets
  - integer, 340
  - tree implementation of, 344
- shakersort, 483
- sharp sign (#), 350, 351
- Shell sort, 481–484, 482, 506
- shift folding, 520, 521
- sibling property, 582
- side edges, 392
- signatures, 17
- simple graphs, 376
- simple prefix B<sup>+</sup>-trees, 316, 318
- Simula, 9
- simulations, 9
  - queues used in, 153
- singly linked lists, 80–86, 81, 216, 314, 573
  - circular, 99
  - deleting nodes, 88, 88–93, 90, 92
  - implementation, 83–85
  - implementation of circular, 99–100
  - implementation of generic, 94–95
  - inserting nodes, 86, 86–88, 87
  - of integers, 85
  - searching, 93
- sink, 405, 407
- skip lists, 101–107
  - efficiency, 106–107, 110
  - implementation, 103–105
  - nodes, 102
  - searching, 102–103, 105–106
- slack, 408
- slow sorting, 516
- small label first method, 389
- Smalltalk, 604
- sorting, 69, 469–514. *See also* decision trees
  - algorithm, 123
  - algorithms, efficient, 481–501



- algorithms, elementary, 470–477
- bubble sort, 475–477
- criteria, 469
- heap sort, 484–488
- insertion sort, 470–473
- in java.util, 502–505
- mergesort, 494–497
- quicksort, 488–494
- radix sort, 497–501
- selection sort, 474–475
- Shell sort, 481–484
- speed, estimating lower bound of, 477
- topological sort, 405–406
- source, in network, 407
- space, 56
  - advantages of arrays, 123–124
  - complexities, algorithms classified by, 62, 63, 64
  - wasted, 114, 323, 352
- space reclamation, 621
- spanning trees, 380, 395–396, 397–398, 399
- sparse tables, 111–114
  - arrays and, for storing student grades, 112
- spell checker: case study, 358–368
  - implementation, using tries, 361–368
- splaying, 262–267
  - heterogeneous configuration, 263, 263, 266
  - homogeneous configuration, 262, 263, 265–266
  - restructuring tree with, 264
- splitting
  - blocks into buddies, 614
  - B\*-trees, 312–313
  - B<sup>+</sup>-tree, 314
  - B-trees, 305–307, 309
  - in hashing, 541–544
  - R-trees, 321
  - simple prefix B<sup>+</sup>-trees, 316
  - 2–4 trees, 327, 328
  - vh-trees, 327–328, 330
- stable marriage problem, 426–428
- stable matching problem, 426–428
- stable sorting, 516
- stacked-node-checking algorithm, 621
- stack frame, 173
- stacks, 140–149, 172–174, 227–230, 402, 452, 498, 616
  - See also run-time stacks
  - applications of, 141, 142–144
  - array list implementation, 146
  - explicit, 616
  - in java.util, 148–149
  - natural implementation for, 146
  - operations, 140
  - operations executed on abstract, 148
  - overflow of, 621
  - used by Java Virtual Machine (JVM), 144–145
- star representation, 377
- statements, 1
  - assignment, 64–66
  - compound, 1
- static binding, 21
- stem, on blossom, 431
- stop-and-copy algorithm, 623, 625, 633
- storage, 14
- straight merging, 516
- stream tokenizers, 202
- string matching, 649–704
  - approximate string matching, 694–704
  - exact string matching, 649–692
- stringology, 649
- strings, 1, 24, 49, 586. See also string matching
  - null, 27
- string variables, 24
- strongly connected components (SCC), 403
- strongly connected graphs, 402
- structures
  - FIFO (first in/first out), 149. See also queues
  - LIFO (last in/first out), 140. See also stacks
- subarrays, 65, 66
- subclasses, 20
- subdirectories, 12
- subgraphs, 377
- suffix arrays, 693–694
- suffix links, 689
- suffix trees, 686–692, 687
- suffix tries, 686–692, 687
- Sun, 32
- Sunday algorithms, 668–670
- superclass, 20
- super-symbols, 591
- sweeping, 621
- symmetric binary B-trees. See 2–4 trees
- symmetric difference, 422
- syntax, 1
- system of distinct representatives theorem, 451
- tables, 111. See also maps
- sparse, 111–114
- tag bit, 617
- tail recursion, 178–179
- Tarjan's algorithm, 403, 404, 405
- temporary variables, 91, 98
- text files, 26
  - tokens extracted from, 28
- theta notation, 61–62
- threaded trees, 231–235, 233
  - implementation of algorithm to insert node into, 241
  - implementation of, and in-order traversal, 234–235
- threads, 233
- 3-colorability problem, 446–448
- 3-nodes, 324
- three-satisfiability problem, 75, 445
- threshold algorithm, 389
- time, 56
  - complexities, algorithms classified by, 62, 63, 64
  - constant, 147
  - polynomial, 448
- tokens, 28
- topological sort, 405–406, 406
- tospace, 625
- tournament, 463
- traces, 694
- tractable problems, 74
- transfer time, 300
- transitive tournament, 463
- transpose method, of organization, 107–110
- traveling salesman problem (TSP), 438–442
- traversal. See tree traversal
- treadmill, 645, 646
- tree edges, 381

- TreeMap, 344–349
  - methods, application of, 348
  - methods of class, 345–347
- trees, 73–74, 199, 215. *See also* tries
  - AVL, 107, 255, 255–260
  - balancing, 249–260, 256, 257
  - of calls for Fib (6), 189
  - defined, 214, 299
  - height of empty and non-empty, 214
  - in java.util, 338–349
  - limitations of, 376
  - multiway. *See* multiway trees
  - orderly, 216
  - representing hierarchical structures, 214, 215
  - representing recursive calls as, 187
  - restructuring, 261, 262
  - self-adjusting, 107, 260–267
  - threaded, 231–235
  - tree traversal, 223–229
- TreeSet, 338–344
  - methods, application of, 341–343
  - methods of class, 338–340
- tree traversal, 223–229, 582
  - breadth-first traversal, 224
  - defined, 223
  - depth-first traversal, 225–231
  - with Morris method, 238
  - stackless depth-first traversal, 231–235
  - through tree transformation, 235–239
- trie *a tergo*, 353
- tries, 349–359, 350, 676
  - compression of, 355, 355–358
  - defined, 349
  - implementation using pseudo-flexible arrays, 360
  - implemented as binary trees, 354
  - space problems of, 352
- Turing machine, 74, 75
- 2-connected graphs, 400
- 2–4 trees, 323–327
  - represented by red-black trees, 325
- two-pointer algorithm, 622
- 2–3–4 trees. *See* 2–4 trees
- types, built-in, and sizes, 2
- Ukkonen algorithm, 689–692, 704
- uncolored degree, of vertex, 444
- underflow, 309, 314
- undirected graphs, connectivity
  - in, 399–400, 402
- Unicode
  - characters, 1, 3
  - codes, 3
- union-find problem, 393–395
- universal coding scheme, 587
- UNIX, 590
  - Hunt-Szymanski algorithm implemented in, 701
  - implementation of Aho-Corasick in, 682
- variable declarations, 1–4
- variables
  - Boolean, 75, 445, 447
  - character, 3
  - class, 12–13
  - in common algebraic operations, 507
  - declarations of, 1–4
  - final, 17
  - initialization of local, 1
  - instance, 12
  - integer, 27
  - nonstatic, 12
  - object, 33
  - reference, 31–35
  - references of compared, 23
  - storage of automatic (local), 172–173
  - string, 24
  - temporary, 91, 98
  - types, 2
  - used in a class, 8
- variant buddy system, 615
- vectors, 35–41, 71
  - cloned, 41
  - inserting elements, 41
  - member functions, 36–39
  - methods for testing status of, 39, 41
  - program demonstrating operation of member functions, 40
- vertex
  - as articulation point, 400, 402
  - independent, 442
  - isolated, 377
  - saturation degree of, 444
  - uncolored degree of, 444
- vertex cover, 448
- vertex cover problem, 448–449
- vertical-horizontal trees. *See* vhtrees
- vertical pointers, 324, 325
- vh-trees, 324–327
- vine. *See* backbone
- virtual hashing, 538
- von Koch snowflakes, 181–185
  - drawing, 182
  - examples of, 182
  - recursive implementation of, 183–185
- Wagner-Fischer algorithm, 696–698
- weakly connected graphs, 402
- weighted buddy system, 614–615
- weighted graphs, 377, 428
- weighted path length, 573
- WFI algorithm, 390, 392, 461
  - execution of, 391
- words, 28
- worst case assessment, 66–69
- worst-fit method, 605
- wrapper classes, 16, 23
- writing
  - bytes, 26–27
  - objects, 29–30
  - primitive data types, 29
  - records, methods for, 50
  - to standard device, 24
- Yuasa’s algorithm, 630–632
- zero-order predictor, 602
- Ziv-Lempel algorithm, 588–589
- Ziv-Lempel code, 587–590